

HARDY

HARDY®

Hardy Price Index By Rice Lake PN

RL PN	SUGGESTED LIST	PAGE #	RL PN	SUGGESTED LIST	PAGE #	RL PN	SUGGESTED LIST	PAGE #
13720	\$9.00/FT	275	0525-0077	\$48.00	272	0525-0200	\$16.00	274
13721	\$4.00/FT	275	0525-0133	\$87.00	270	0525-0203	\$51.00	268
0525-0035	\$203.00	275	0525-0134	\$106.00	270	0525-0204	\$19.00	274
*0525-0037	\$160.00	275	0525-0143	\$68.00	269	0525-0207	\$53.00	268
0525-0045	\$216.00	275	0525-0144	\$72.00	269	0525-0208	\$20.00	274
0525-0047	\$216.00	275	0525-0146	\$68.00	269	0525-0215	\$98.00	273
0525-0049	\$223.00	275	0525-0147	\$73.00	269	0525-0216	\$101.00	273
0525-0051	\$223.00	275	0525-0148	\$66.00	269	0525-0223	\$106.00	273
0525-0053	\$241.00	275	0525-0149	\$71.00	270	0525-0224	\$102.00	273
0525-0055	\$241.00	275	0525-0152	\$196.00	274	0525-0225	\$116.00	273
0525-0056	\$53.00	272	0525-0153	\$209.00	274	0525-0226	\$116.00	273
0525-0057	\$16.00	274	0525-0154	\$216.00	274	0525-0227	\$141.00	273
0525-0059	\$39.00	271	0525-0155	\$236.00	274	0525-0228	\$141.00	273
0525-0060	\$33.00	272	0525-0156	\$273.00	274	0525-0507	\$37.00	271
0525-0061	\$24.00	271	0525-0194	\$50.00	268	0525-0508	\$38.00	271
0525-0063	\$25.00	271	0525-0195	\$73.00	268	0525-0509	\$39.00	271
0525-0064	\$26.00	271	0525-0196	\$48.00	268			
0525-0070	\$54.00	272	0525-0199	\$48.00	268			
0525-0074	\$41.00	272						
0525-0075	\$47.00	272						

*Item obsolete or discontinued. When remaining stock is depleted, published prices are withdrawn and the item is subject to a special order quote.

Call for details.

Hardy Cross Reference By Equivalent Hardy Number

EQUIV. HARDY #	RL PN	PAGE #	EQUIV. HARDY #	RL PN	PAGE #	EQUIV. HARDY #	RL PN	PAGE #
2K201	0525-0060	272	7K201	0525-0075	272	10K2001	0525-0133	270
2K308	0525-0041	XX	7K303 (OLD)	0525-0508	271	10K2002	0525-0134	270
2K309	0525-0043	XX	7K308	0525-0053	275	10KX2000	0525-0151	XX
2K1203	0525-0196	268	7K309	0525-0055	275	12K201	0525-0070	272
2KX111	0525-0225	273	7K1203	0525-0203	268	12K303	0525-0059	271
3K303	0525-0061	271	7K1205	0525-0204	274	12K309	0525-0266	XX
3K303 (OLD)	0525-0507	271	7K2001	0525-0148	269	12K1203	0525-0221	XX
3K308	0525-0045	275	7K2002	0525-0149	270	13K711	0525-0033	XX
3K309	0525-0047	275	7KX111	0525-0227	273	13K1303	0525-0194	268
3K2001	0525-0143	269	7KX2000	0525-0155	274	13K1314	0525-0195	268
3K2002	0525-0144	269	8K201	0525-0077	272	13K1408	0525-0012	XX
3KX2000	0525-0152	274	8K303	0525-0064	271	13K1409	0525-0013	XX
4K201	0525-0074	272	8K303 (OLD)	0525-0509	271	13K1410	0525-0014	XX
4K308	0525-0049	275	8K1203	0525-0207	268	13KX109	0525-0223	273
4K309	0525-0051	275	8K1205	0525-0208	274	13KX110	0525-0224	273
4K1203	0525-0199	268	8KX111	0525-0228	273	16K201	0525-0174	XX
4K1205	0525-0200	274	8KX2000	0525-0156	274	D2542-9-B	0525-0181	XX
4KX111	0525-0226	273	10K201	0525-0056	272	KX123	0525-0215	273
4KX2000	0525-0153	274	10K308	0525-0035	275	KX124	0525-0216	273
5K2001	0525-0146	269	10K309	0525-0037	275	KX142	0525-0217	XX
5K2002	0525-0147	269	10K311	0525-0057	274			
5KX2000	0525-0154	274	10K1203	0525-0190	XX			

*Item obsolete or discontinued. When remaining stock is depleted, published prices are withdrawn and the item is subject to a special order quote.

XX Call for details.

Hardy Scale Models and Gross Capacities

MODEL	GROSS CAPACITY
HS-1	0-625 LB
HS-2	626-1,250 LB
HS-3	1,251-2,500 LB
HS-4	2,501-6,250 LB
HS-5	6,251-7,500 LB
HS-6	7,501-11,250 LB
HS-7	11,251-25,000 LB
HS-8	12,501-25,000 LB
HS-9	25,001-30,000 LB
HS-10	30,001-37,500 LB
HS-11	37,501-50,000 LB
HS-12	50,001-62,500 LB

Individual Hardy Scale Parts

Bearings

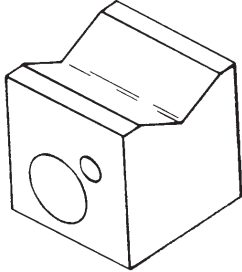
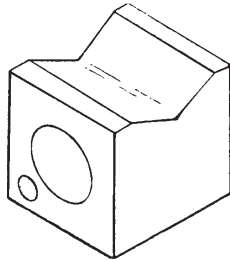
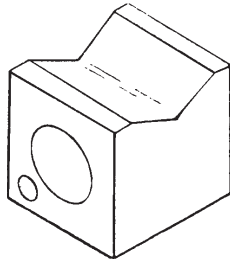
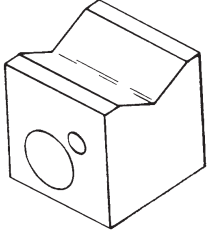
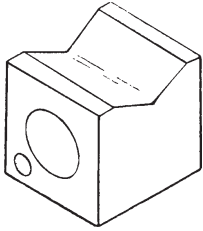
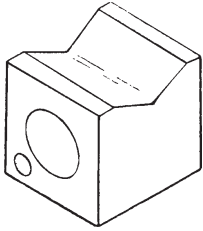
RL PN	DESCRIPTION	SUGG. LIST	
0525-0194	Equiv. Hardy no. 13K1303 Size: 15/16 in x 15/16 in x 1 1/32 in Hole size: 0.453 or 29/64 in dia Spacer: 0525-0200 Fits shackle no. 0525-0223, 0525-0224 Extension lever: all models (1/2 in bar) Type A Bearing	\$50.00	
0525-0195	Equiv. Hardy no. 13K1314 Size: 1 1/4 in x 1 1/4 in x 1 7/16 in Hole size: 0.578 or 37/64 in dia Spacer: 0525-0204 Fits shackle no. 0525-0217 Extension lever: H.D. (3/4 in bar) Type B Bearing	\$73.00	 TYPE B
0525-0196	Equiv. Hardy no. 2K1203 Size: 15/16 in x 15/16 in x 31/32 in Hole size: 0.453 or 29/64 in dia Spacer: 0525-0200 Fits shackle no. 0525-0225 Models: hs-1, HS-2 Type A Bearing	\$48.00	 TYPE C
0525-0199	Equiv. Hardy no. 4K1203 Size: 15/16 in x 15/16 in x 29/32 in Hole size: 0.453 in or 29/64 in dia Spacer: 0525-0200 Fits shackle no. 0525-0215 Models: HS-3, HS-4 Type A Bearing	\$48.00	 TYPE A
0525-0203	Equiv. Hardy no. 7K1203 Size: 1 1/4 in x 1 1/4 in x 1 3/16 in Hole size: 0.578 in or 37/64 in dia Spacer: 0525-0204 Fits shackle no. 0525-0227 Models: hs-5, HS-6, HS-7 Type B Bearing	\$51.00	
0525-0207	Equiv. Hardy no. 8K1203 Size: 1 1/4 in x 1 1/2 in x 1 3/8 in Hole size: 0.719 in or 23/32 in dia Spacer: 0525-0208 Fits shackle no. 0525-0228 Model: HS-8 Type B Bearing	\$53.00	 TYPE B

Individual Hardy Scale Parts

Bearings (Cont.)

RL PN	DESCRIPTION	SUGG. LIST
0525-0143	<p>Equiv. Hardy no. 3K2001 Size: 1 1/4 in x 5/8 in x 2 3/16 in Hole size: 3/8 in dia x 1 9/16 in center to center Fits shackle no. 0525-0152 Models: HS-1, HS-2, HS-3 Upper bearing</p>	\$68.00
0525-0144	<p>Equiv. Hardy no. 3K2002 Size: 1 1/4 in x 5/8 in x 3 5/8 in Hole size: 3/8 in dia x 3 in center to center Fits shackle no. 0525-0152 Models: HS-1, HS-2, HS-3 Lower bearing</p>	\$72.00
0525-0146	<p>Equiv Hardy no. 5K2001 Size: 1 1/4 in x 3/4 in x 2 5/8 in Hole size: 1/2 in dia x 1 3/4 in center to center Fits shackle no. 0525-0153, 0525-0154 Models: HS-4, HS-5 Upper bearing</p>	\$68.00
0525-0147	<p>Equiv. Hardy no. 5K2002 Size: 1 1/4 in x 3/4 in x 4 1/2 in Hole size: 1/2 in dia x 3 5/8 in center to center Fits shackle no. 0525-0153, 0525-0154 Models: HS-4, HS-5 Lower bearing</p>	\$73.00
0525-0148	<p>Equiv. Hardy no. 7K2001 Size: 1 1/4 in x 3/4 in x 3 9/16 in Hole size: 5/8 in dia x 2 7/16 in center to center Fits shackle no. 0525-0155 Models HS-6, HS-7</p>	\$66.00

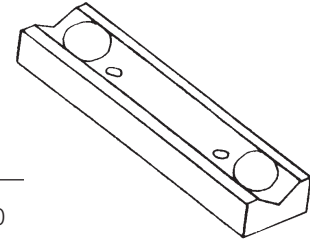

HARDY®

Individual Hardy Scale Parts

Bearings (Cont.)

RL PN	DESCRIPTION	SUGG. LIST
0525-0149	Equiv. Hardy no. 7K2002 Size: 1 1/4 in x 3/4 in x 5 3/4 in Hole size: 5/8 in dia x 4 5/8 in center to center Fits shackle no. 0525-0155 Models: HS-6, HS-7 Lower bearing	\$71.00
0525-0133	Equiv. Hardy no. 10K2001 Size: 1 1/4 in x 1 in x 3 7/8 in Hole size: 11/16 in dia x 2 5/8 in center to center Fits shackle no. 0525-0156, 0525-0151 Models: HS-8, HS-9, HS-10 Upper bearing	\$87.00
0525-0134	Equiv. Hardy no. 10K2002 Size: 1 1/4 in x 1 in x 6 3/8 in Hole size: 11/16 in dia x 5 1/8 in center to center Fits shackle no. 0525-0156, 0525-0151 Models: HS-8, HS-9, HS-10 Lower bearing	\$106.00

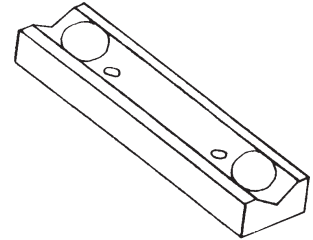

Individual Hardy Scale Parts

Pivots

RL PN	DESCRIPTION	SUGG. LIST
0525-0061	Equiv. Hardy no. 3K303 Size: 1/2 in x 1/2 in x 1/2 in Fits splice nose iron: 0525-0041, 0525-0043, 0525-0045, 0525-0047 Models: HS-1, HS-2, HS-3 Pivot	\$24.00
0525-0063	Equiv. Hardy no. 7K303 Size: 1/2 in x 1/2 in x 5/8 in Fits splice nose iron: 0525-0049, 0525-0051, 0525-0053, 0525-0055 Models: HS-4, HS-5, HS-6, HS-7 Pivot	\$25.00
0525-0064	Equiv. Hardy no. 8K303 Size: 1/2 in x 1/2 in x 3/4 in Fits splice nose iron: 0525-0035, 0525-0037 Models: HS-8, HS-9, HS-10 Pivot	\$26.00
0525-0059	Equiv. Hardy no. 12K303 Size: 1/2 in x 3/4 in x 1 in Fits splice nose iron: 0525-0265, 0525-0266 Models: HS-11, HS-12 Pivot	\$39.00
0525-0507	Equiv. Hardy no. 3K303 - old style Size: 1/2 in x 3/4 in x 1/2 in Fits splice nose iron: 0525-0041, 0525-0043, 0525-0045, 0525-0047 Models: HS-1, HS-2, HS-3 Pivot	\$37.00
0525-0508	Equiv hardy no. 7K303 - old style Size: 1/2 in x 3/4 in x 5/8 in Fits splice nose iron: 0525-0049, 0525-0051 0525-0053, 0525-0055 Models: HS-4, HS-5, HS-6, HS-7 Pivot	\$38.00
0525-0509	Equiv. Hardy no. 8K303 - old style Size: 1/2 in x 3/4 in x 3/4 in Fits splice nose iron: 0525-0035, 0525-0037 Models: HS-8, HS-9 Pivot	\$39.00

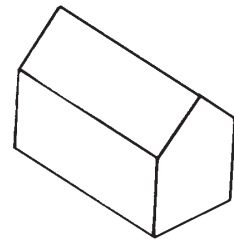
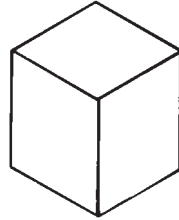

HARDY®

Individual Hardy Scale Parts

Pivots (Cont.)

RL PN	DESCRIPTION	SUGG. LIST
0525-0060	Equiv. Hardy no. 2K201 Size: 3/8 in x 3/8 in x 3 1/2 in Load and fulcrum: main lever Models: HS-1, HS-2 Pivot	\$33.00
0525-0074	Equiv. Hardy no. 4K201 Size: 1/2 in x 1/2 in x 3 1/2 in Load and fulcrum: main lever Models: HS-3, HS-4 Pivot	\$41.00
0525-0075	Equiv. Hardy no. 7K201 Size: 5/8 in x 5/8 in x 4 in Load and fulcrum: main lever Model: HS-5, HS-6, HS-7 Pivot	\$47.00
0525-0077	Equiv. Hardy no. 8K201 Size: 3/4 in x 3/4 in x 4 5/8 in Load and fulcrum: main lever Models: HS-8 Pivot	\$48.00
0525-0056	Equiv. Hardy no. 10K201 Size: 1/2 in x 3/4 in x 2 5/8 in Load and fulcrum: main lever Models: HS-9, HS-10 Pivot	\$53.00
0525-0070	Equiv. Hardy no. 12K201 Size: 1/2 in x 3/4 in x 3 1/4 in Load and fulcrum: main lever Models: HS-11, HS-12 Pivot	\$54.00

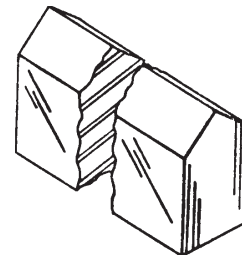
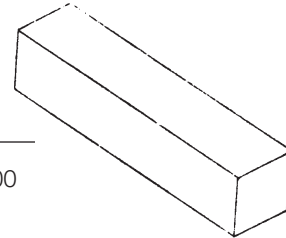

HARDY[®]

Individual Hardy Scale Parts

Loops

RL PN	DESCRIPTION	SUGG. LIST
0525-0215	Equiv. Hardy no. KX123 Size: A. 2 29/32 in B. 1 in C. 1 1/16 in Uses bearing no. 0525-0199 Loop	\$98.00
0525-0216	Equiv. Hardy no. KX124 Size: A. 2 29/32 in B. 1 in C. 15/16 in Uses bearing no. 0525-0196 Loop	\$101.00
0525-0223	Equiv. Hardy no. 13KX109 Size: A. 2 17/32 in B. 1 in C. 13/16 in Uses bearing no. 0525-0194 Loop	\$106.00
0525-0224	Equiv. Hardy no. 13KX110 Size: A. 1 27/32 in B. 1 in C. 13/16 in Uses bearing no. 0525-0194 Loop	\$102.00
0525-0225	Equiv. Hardy no. 2KX111 Size: A. 2 17/32 in B. 1 in C. 15/16 in Uses bearing no. 0525-0196 Loop	\$116.00
0525-0226	Equiv. Hardy no. 4KX111 Size: A. 2 17/32 in B. 1 in C. 1 1/16 in Uses bearing no. 0525-0199 Loop	\$116.00
0525-0227	Equiv. Hardy no. 7KX111 Size: A. 3 in B. 1 9/32 in C. 1 9/16 in Uses bearing no. 0525-0203 loop	\$141.00
0525-0228	Equiv. Hardy no. 8KX111 Size: A. 3 9/32 in B. 1 5/16 in C. 1 1/2 in Uses bearing no. 0525-0207 Loop	\$141.00

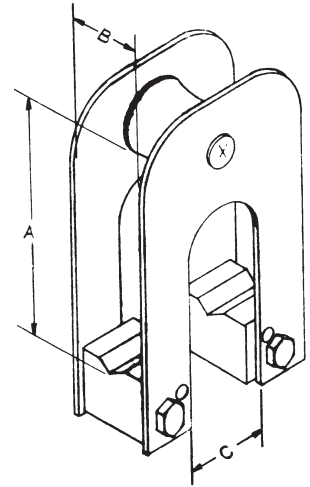

HARDY®

Individual Hardy Scale Parts

Miscellaneous

RL PN	DESCRIPTION	SUGG. LIST
0525-0152	Equiv. Hardy no. 3Kx2000 Steelyard rod dia 1/2 in Top bearing: 0525-0143 Bottom bearing: 0525-0144 Models: HS-1, HS-2, HS-3 Shackle assembly	\$196.00
0525-0153	Equiv. Hardy no. 4Kx2000 Steelyard rod dia 1/2 in Top bearing: 0525-0146 Bottom bearing: 0525-0147 Model: HS-4 Shackle assembly	\$209.00
0525-0154	Equiv. Hardy no. 5Kx2000 Steelyard rod dia 5/8 in Tip bearing: 0525-0146 Bottom bearing: 0525-0147 Model: HS-5 Shackle assembly	\$216.00
0525-0155	Equiv. Hardy no. 7Kx2000 Steelyard rod dia 5/8 in Top bearing: 0525-0148 Bottom bearing: 0525-0149 Models: hs-6, hs-7 Shackle assembly	\$236.00
0525-0156	Equiv. Hardy no. 8Kx2000 Steelyard rod dia 3/4 in Top bearing: 0525-0133 Bottom bearing: 0525-0134 Model: HS-8 Shackle assembly	\$273.00
0525-0057	Equiv. Hardy no. 10K311 Size: 1/4 in x 3/4 in x 1 3/4 in Models: HS-8, HS-9, HS-10 Nose iron retainer plate	\$16.00
0525-0200	Equiv. Hardy no. 4K1205 Size: 7/16 in O.D. x 1 in Bearing spacer	\$16.00
0525-0204	Equiv. Hardy no. 7K1205 Size: 9/16 in O.D. x 1 9/32 in Bearing spacer	\$19.00
0525-0208	Equiv. Hardy no. 8K1205 Size: 11/16 in O.D. x 1 5/16 in Bearing spacer	\$20.00

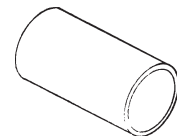
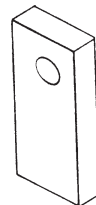
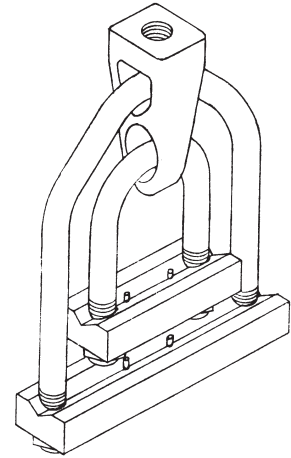

HARDY®

Individual Hardy Scale Parts

Miscellaneous (Cont.)

RL PN	DESCRIPTION	SUGG. LIST
13720	Cable Size: 1/8 in dia	\$9.00/Ft
13721	Cable Size: 3/16 in dia	\$4.00/Ft
0525-0035 (B)	Equiv Hardy no. 10K308 size: 3/4 in x 3 15/16 in x 8 15/16 in Uses pivot no. 0525-0064 Models: HS-8, HS-9, HS-10, R.H., nose iron	\$203.00
*0525-0037 (B)	Equiv. Hardy no. 10K309 size: 3/4 in x 3 15/16 in x 8 15/16 in Uses pivot no. 0525-0064 Models: HS-8, HS-9, HS-10, I.H., nose iron	\$160.00
0525-0045 (B)	Equiv. Hardy no. 3K308 size: 1/2 in x 3 1/32 in x 8 5/16 in Uses pivot no. 0525-0061 Models: HS-3, R.H., nose iron	\$216.00
0525-0047 (B)	Equiv. Hardy no. 3K309 size: 1/2 in x 2 7/16 in x 8 5/16 in Uses pivot no. 0525-0061 Models: HS-3, I.H., nose iron	\$216.00
0525-0049 (B)	Equiv. Hardy no. 4K308 size: 5/8 in x 3 11/32 in x 8 5/16 in Use pivot no. 0525-0063 Models: HS-4, R.H., nose iron	\$223.00
0525-0051 (B)	Equiv. Hardy no. 4K309 size: 5/8 in x 2 7/16 in x 8 5/16 in Uses pivot no. 0525-0063 Models: HS-4, I.H., nose iron	\$223.00
0525-0053 (B)	Equiv. Hardy no. 7K308 size: 5/8 in x 2 15/16 in x 8 5/16 in Use pivot no. 0525-0063 Models: HS-5, HS-6, HS-7, R.H., nose iron	\$241.00
0525-0055 (B)	Equiv. Hardy no. 7K309 size: 5/8 in x 2 15/16 in x 8 5/16 in Use pivot no. 0525-0063 Models: HS-5, HS-6, HS-7, I.H., nose iron	\$241.00

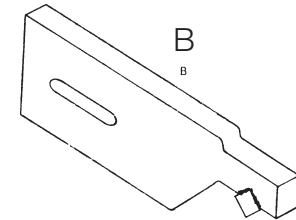
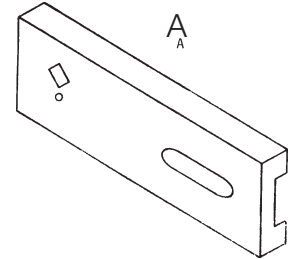

HARDY®

HARDY KITS

HARDY®

Hardy Kit Price Index By Rice Lake PN

RL PN	SUGGESTED LIST	PAGE #	RL PN	SUGGESTED LIST	PAGE #	RL PN	SUGGESTED LIST	PAGE #
HS-101-K	\$948.00	279	HS-106-K	\$1,193.00	281	HS-204-K	\$1,699.00	280
HS-103-K	\$931.00	279	HS-108-K	\$1,413.00	281	HS-205-K	\$1,692.00	280
HS-104-K	\$921.00	280	HS-203-K	\$1,666.00	279	HS-206-K	\$2,158.00	281
HS-105-K	\$1,193.00	280				HS-208-K	\$2,082.00	281

*Item obsolete or discontinued. When remaining stock is depleted, published prices are withdrawn and the item is subject to a special order quote.

XX Call for details.

Hardy Kit Reference By Capacity

Pivot and Bearing Kits			Kits With Complete Assemblies		
CAPACITY (LB)	RL PN	PAGE #	CAPACITY (LB)	RL PN	PAGE #
0-1,250	HS-101-K	279	0-1,250	HS-201-K	XX
1,251-2,500	HS-103-K	279	1,251-2,500	HS-203-K	279
2,501-6,250	HS-104-K	280	2,501-6,250	HS-204-K	280
6,251-7,500	HS-105-K	280	6,251-7,500	HS-205-K	280
7,501-12,500	HS-106-K	281	7,501-12,500	HS-206-K	281
12,501-25,000	HS-108-K	281	12,501-25,000	HS-208-K	281
25,001-37,500	HS-109-K	XX	25,001-37,500	HS-209-K	XX

*Item obsolete or discontinued. When remaining stock is depleted, published prices are withdrawn and the item is subject to a special order quote.

XX Call for details.

Hopper Scale

Kit No. HS-101-K

Pivots and Bearings Only For The Main Levers, Models HS-1 and HS-2, 0-1, 250 lb Capacity

QTY	RL PN	DESCRIPTION
16.....	0525-0196.....	Bearing, main lever load and fulcrum
16.....	0525-0200.....	Bearing, spacer
8.....	0525-0060.....	Pivot, main lever load and fulcrum
2.....	0525-0061.....	Pivot, main lever tip (new style)
2.....	0525-0507.....	Pivot, main lever tip
1.....	0525-0143.....	Bearing, top of splice shackle
1.....	0525-0144.....	Bearing, bottom of splice shackle

\$948.00 Suggested list/5 lb shipping weight

Kit No. HS-103-K

Pivots and Bearings Only For The Main Levers Model HS-3, 1, 251-2, 500 lb Capacity

QTY	RL PN	DESCRIPTION
16.....	0525-0199.....	Bearing, main lever load and fulcrum
16.....	0525-0200.....	Bearing, spacer
8.....	0525-0074.....	Pivot, main lever load and fulcrum
2.....	0525-0061.....	Pivot, main lever tip (new style)
2.....	0525-0507.....	Pivot, main lever tip
1.....	0525-0143.....	Bearing, top of splice shackle
1.....	0525-0144.....	Bearing, bottom of splice shackle

\$931.00 Suggested list/7 lb shipping weight

Kit No. HS-203-K

This Kit Fits The Main Levers Model HS-3, 1, 251-2, 500 lb Capacity But Has Complete Assemblies

QTY	RL PN	DESCRIPTION
8.....	0525-0226.....	Loop, main lever
8.....	0525-0074.....	Pivot, main lever
1.....	0525-0045.....	Pivot with nose iron
1.....	0525-0047.....	Pivot with nose iron
1.....	0525-0152.....	Shackle assembly

\$1,666.00 Suggested list/18 lb shipping weight

HARDY® KITS

Hopper Scale

Kit No. HS-104-K

Pivots and Bearings Only For The Main Levers Model HS-4, 2, 501-6, 250 lb Capacity

QTY	RL PN	DESCRIPTION
16.....	0525-0199.....	Bearing, main lever load and fulcrum
16.....	0525-0200.....	Bearing, spacer
8.....	0525-0074.....	Pivot, main lever load and fulcrum
2.....	0525-0063.....	Pivot, main lever tip (new style)
2.....	0525-0508.....	Pivot, main lever tip
1.....	0525-0146.....	Bearing, top of splice shackle
1.....	0525-0147.....	Bearing, bottom of splice shackle

\$921.00 Suggested list/6 lb shipping weight

Kit No. HS-204-K

This Kit Fits The Main Lever Model HS-4, 2, 501-6, 250 lb Capacity Scale But Has Complete Assemblies

QTY	RL PN	DESCRIPTION
8.....	0525-0226.....	Loop, main lever
8.....	0525-0074.....	Pivot, main lever load and fulcrum
1.....	0525-0049.....	Pivot with nose iron, r.H.
1.....	0525-0051.....	Pivot with nose iron, l.H.
1.....	0525-0153.....	Shackle assembly

\$1,699.00 Suggested list/21 lb shipping weight

Kit No. HS-105-K

Pivots and Bearings Only For The Main Levers Model HS-5, 6, 251-7, 500 lb Capacity

QTY	RL PN	DESCRIPTION
16.....	0525-0203.....	Bearing, main lever load and fulcrum
16.....	0525-0204.....	Bearing, spacer
8.....	0525-0075.....	Pivot, main lever load and fulcrum
2.....	0525-0063.....	Pivot, main lever tip (new style)
2.....	0525-0508.....	Pivot, main lever tip
1.....	0525-0146.....	Bearing, top of splice shackle
1.....	0525-0147.....	Bearing, bottom of splice shackle

\$1,193.00 Suggested list/11 lb shipping weight

Kit No. HS-205-K

This Kit Fits The The Main Levers Model HS-5, 6, 251-7, 500 lb Capacity But Has Complete Assemblies

QTY	RL PN	DESCRIPTION
8.....	0525-0227.....	Loop, main lever load and fulcrum
8.....	0525-0075.....	Pivot, main lever load and fulcrum
1.....	0525-0053.....	Pivot with nose iron, R.H.
1.....	0525-0055.....	Pivot with nose iron, l.H.
1.....	0525-0154.....	Shackle assembly

\$1,692.00 Suggested list/37 lb shipping weight

Hopper Scale

Kit No. HS-106-K

Pivots and Bearings Only For The Main Levers, Models HS-6 and HS-7, 7, 501-12, 500 lb Capacity

QTY	RL PN	DESCRIPTION
16.....	0525-0203.....	Bearing, main lever load and fulcrum
16.....	0525-0204.....	Bearing, spacer
8.....	0525-0075.....	Pivot, main lever load and fulcrum
2.....	0525-0063.....	Pivot, main lever tip (new style)
2.....	0525-0508.....	Pivot, main lever tip
1.....	0525-0148.....	Bearing, top of splice shackle
1.....	0525-0149.....	Bearing, bottom of splice shackle

\$1,193.00 Suggested list/12 lb shipping weight

Kit No. HS-206-K

This Kit Fits The Main Levers, Models HS-6 and HS-7, 7, 501-12, 500 lb Capacity But Has Complete Assemblies

QTY	RL PN	DESCRIPTION
8.....	0525-0227.....	Loop, main lever load and fulcrum
8.....	0525-0075.....	Pivot, main lever load and fulcrum
1.....	0525-0053.....	Pivot with nose iron, R.H.
1.....	0525-0055.....	Pivot with nose iron, I.H.
1.....	0525-0155.....	Shackle assembly

\$2,158.00 Suggested list/39 lb shipping weight

Kit No. HS-108-K

Pivots and Bearings For The Main Levers, Models HS-8, 12, 501-25,000 lb Capacity

QTY	RL PN	DESCRIPTION
16.....	0525-0207.....	Bearing, main lever load and fulcrum
16.....	0525-0208.....	Bearing, spacer
8.....	0525-0077.....	Pivot, main lever load and fulcrum
2.....	0525-0064.....	Pivot, main lever tip (new style)
2.....	0525-0509.....	Pivot, main lever tip
1.....	0525-0133.....	Bearing, top of splice shackle
1.....	0525-0134.....	Bearing, bottom of splice shackle

\$1,413.00 Suggested list/18 lb shipping weight

Kit No. HS-208-K

This Kit Fits The Main Levers, Models HS-8, 12, 501-25,000 lb Capacity But Has Complete Assemblies

QTY	RL PN	DESCRIPTION
8.....	0525-0228.....	Loop, main lever load and fulcrum
8.....	0525-0077.....	Pivot, main lever load and fulcrum
1.....	0525-0035.....	Pivot with nose iron, R.H.
1.....	0525-0037.....	Pivot with nose iron, I.H.
1.....	0525-0156.....	Shackle assembly

\$2,082.00 Suggested list/64 lb shipping weight

HARDY® KITS

