

# GR SERIES

## INSTRUCTION MANUAL

---

### Analytical Balance

Model GR-120  
GR-200  
GR-300  
GR-202



This is a hazard alert mark.



This is an information mark that informs you about the operation of the balance.

**NOTE** This manual and or the GR series balances may be changed at any time to improve the product without notice.



# Contents

## Basic Operation

1. Introduction .....	3
Compliance with FCC Rules .....	4
Compliance with EMC Directives .....	4
2. Caution .....	5
Precautions for Installing the Balance .....	5
Cautions during use (To get best performance) .....	6
Take Care of Your Balance .....	7
Power Supply .....	7
3. Unpacking your balance .....	8
Installing your Balance .....	9
Display Symbols and Key Operation .....	9
4. Weighing Units .....	11
5. Weighing .....	13
Basic Operation (gram mode) .....	13
Counting Mode (pcs) .....	14
Percent Mode (%) .....	15

## Adapting to the Environment

6. Response Adjustment .....	16
Automatic Response Adjustment .....	16
Manual Response Adjustment .....	17
7. Calibration .....	18
Calibration Group .....	18
Automatic Self Calibration .....	19
Calibration Using the Internal Weight .....	20
Calibration Test Using the Internal Weight .....	21
Calibration Using an External Weight .....	22
Calibration Test Using an External Weight .....	24
Correcting the Internal Weight Value .....	26

## Functions

8. Function Switch and Initialization .....	28
Permission or Prohibition .....	28
Initializing the Balance .....	29
9. Function Table .....	30
Display and Keys of the Function Table .....	31
Details of the Function Table .....	32
Explanation of Item "Environment, Display" .....	34
Explanation of Item "Data output mode" .....	35
Explanation of Item "Data format" .....	36
Examples of data format .....	38



# 1. Introduction

## *THANK YOU FOR YOUR A&D PURCHASE*

This manual will tell you in simple language how this balance works and how to get the most out of it in terms of performance.

### Chapters of this book

- Basic operation ..... Please read this chapter before use. cautions, basic operation and names are described.
- Adapting to the environment ... Explanations concerning response adjustment, calibration and calibration test.
- Functions ..... Functions and parameters for the balance.
- Serial interface (RS-232C) ..... This interface transmits data and can control the balance.
- Maintenance ..... Maintenance, error code list, options, terms and index.

### Features

- Built-in Calibration Weight (internal weight), used to calibrate and verify the calibration of your balance.
- Automatic Self Calibration, using the built-in weight, adapting to changes in temperature.
- Automatic Response Adjustment, adapting to vibration and drafts in the environment.
- Data Memory Function, storing 200 weighing data.
- Interval Memory Mode, storing weighing data periodically.
- Good Laboratory Practices (GLP) data output using a serial interface.
- Under Hook, for measuring specific gravity and magnetic substances.
- The balance is equipped with the specific gravity measuring mode to calculate the specific gravity (density) of a solid.
- Multiple Weighing Units, with most of the common units used around the world.
- RS-232C serial interface, for transmitting data and controlling your balance.
- Door Control Lever, a front mounted door control can easily open and close one of the side doors if connected using the door joint.



## Compliance with FCC Rules

Please note that this equipment generates, uses and can radiate radio frequency energy. This equipment has been tested and has been found to comply with the limits of a Class A computing device pursuant to Subpart J of Part 15 of FCC rules. These rules are designed to provide reasonable protection against interference when equipment is operated in a commercial environment. If this unit is operated in a residential area it might cause some interference and under these circumstances the user would be required to take, at his own expense, whatever measures are necessary to eliminate the interference.

(FCC = Federal Communications Commission in the U.S.A.)



## Compliance with EMC Directives

**CE** This device features radio interference suppression in compliance with valid EC Regulation 89/366/EEC.

- Note 1 The displayed value may be adversely affected under extreme electromagnetic influences.
- 2 Protect the RS-232C connector from extreme electrostatic discharge when peripheral equipment is not connected.  
Protect the AC adapter jack from extreme electrostatic discharge when the AC adapter is not connected.



## 2. Caution



### Precautions for Installing the Balance

To ensure that you get the most from your balance, please try to follow these conditions as closely as possible:

- The best operating temperature is about 20°C / 68°F at about 50% Relative Humidity.
  - Try to ensure a stable power source when using the AC adapter.
  - Please warm-up the balance for at least one hour. Plug-in the AC adapter as usual.
  - The weighing room should be free of dust.
  - The weighing table should be solid and free from vibration, drafts (such as frequently opening doors or windows) and as level as possible.
  - Keep the balance level by using the bubble spirit level.
  - Don't install the balance near heaters or air conditioners.
  - Don't install the balance in direct sunlight.
  - Don't use the balance near other equipment which produces magnetic fields.
  - Corners of rooms are best as they are less prone to vibrations.
  - Calibrate the balance before using and after moving it to another location.
-  **Do not place or use the balance where there is flammable or corrosive gas present.**

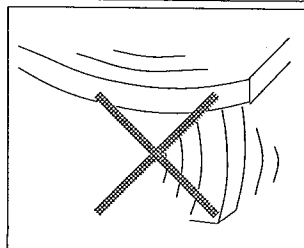
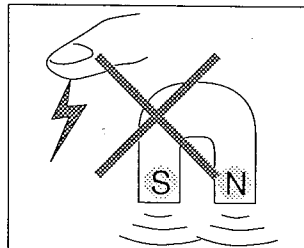
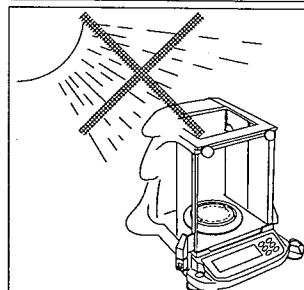
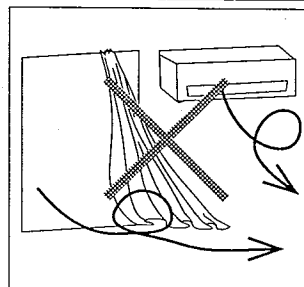
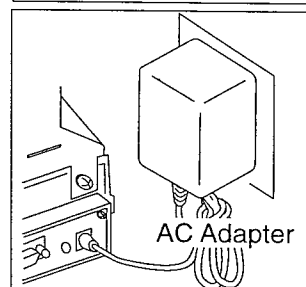
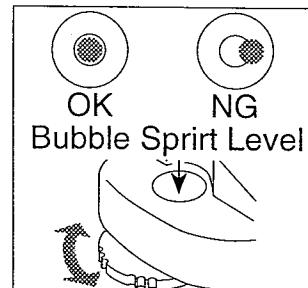



## Cautions during use (To get best performance)

Note the following items to get accurate weighing data.

- Press the **RE-ZERO** key before each weighing to prevent possible error.
- Calibrate the balance periodically so as to cancel possible weighing error.
- Make each weighing quickly to avoid errors due to changes in the environmental conditions.
- Close glass doors to keep out drafts.
- Do not drop things upon the weighing pan, or place a weight beyond the range of the balance on the weighing pan.
- Do not use a sharp instrument (such as a pencil or ball point pen) to press the keys, use your finger only.
- To weigh properly with a minimum display of 0.01 mg using the GR-202, replace the breeze break ring with the fine range breeze break ring. See page 8 for details.
- Discharge static electricity from the weighed matter. When weighing material (plastics, insulator, etc.) could have a static charge, the weight value is influenced. Try to keep the ambient humidity above 45%RH or to use the metal shield case.
- This balance uses a strong magnet as part of the balance assembly, so please use caution when weighing magnetic materials. If there is a problem, use the underhook (on the bottom of the balance) to suspend the material away from the influence of the magnet.
- Cancel the temperature difference between the weighed material and the environment. When a sample is warmer (cooler) than the ambient temperature, the sample will lighter (heavier) than true weight. This error is due to the rising (falling) draft next the sample.
- Take into consideration the affect of air buoyancy on a sample when more accuracy is required.

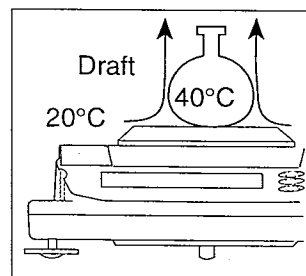
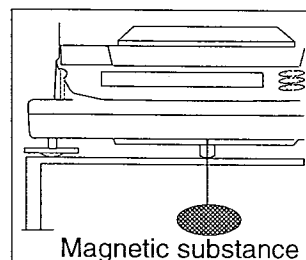
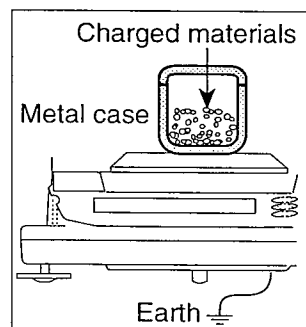
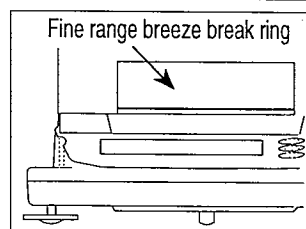
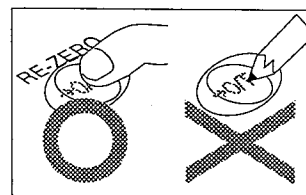
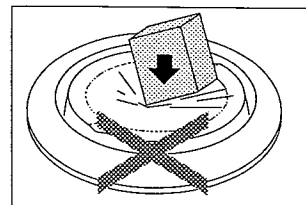

- ❑ Operate your balance gently. Shorten the operation time as much as possible (Opening and closing door, placing and removing material). Use a pair of tweezers (pincette) to avoid temperature changes due to heat from inserting your hand into the weighing chamber.

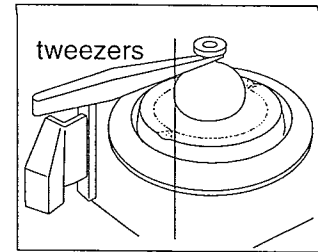

## Take Care of Your Balance

- ❑ Don't disassemble the balance. Contact your local A&D dealer if your balance needs service or repair.
- ❑ Don't use solvents to clean the balance. For best cleaning, wipe with a dry lint free cloth or a lint free cloth that is moistened with warm water and a mild detergent.
- ❑ When you transport the balance, hold it as shown in the right illustration. Never lift the balance using the weighing chamber frame.
- ❑ Keep magnetic substance away from the balance.
- ❑ Avoid mechanical shock to your balance.
- ❑ Avoid dust and water so that the balance weighs correctly. Protect the internal parts from liquid spills and excessive dust.
- ❑ Remove and clean the floor plate of the weighing chamber.
- ❑ Use the special shipping box supplied for transportation.

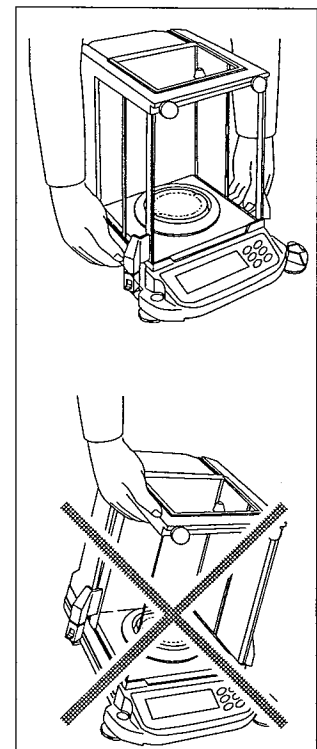

## Power Supply

- ❑ When the AC adapter is connected, the balance is in the standby mode if the standby indicator is on (see "Display Symbols and Key Operation"). This is a normal state and does not harm the balance. We recommend that you plug in your balance for at least an hour before use so it can warm up.





# 3. Unpacking your balance

- ❑ Unpack the balance carefully and keep the packing material if you want to transport the balance again in the future.
- ❑ In the carton you should find this manual plus :

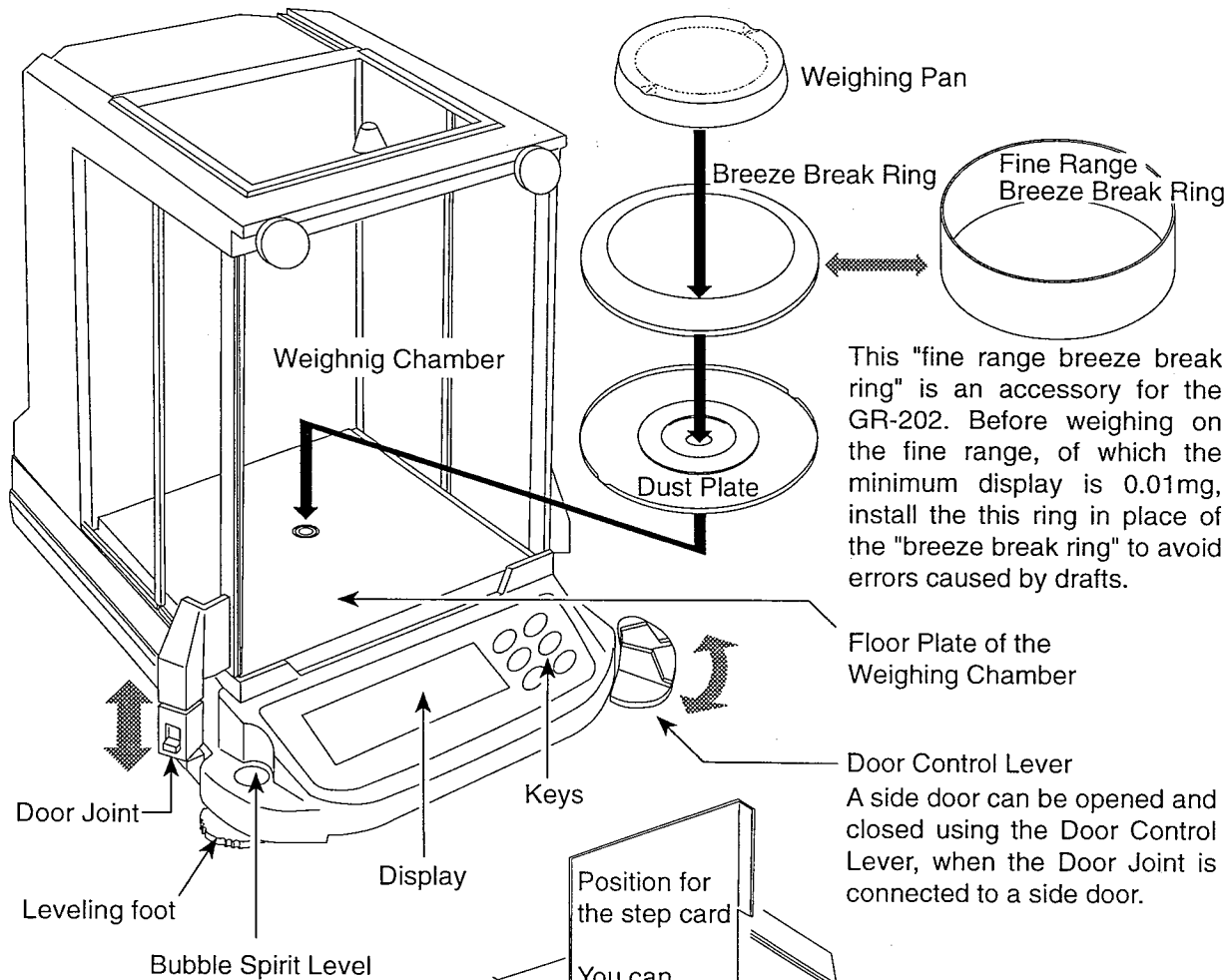

This "fine range breeze break ring" is an accessory for the GR-202. Before weighing on the fine range, of which the minimum display is 0.01mg, install the this ring in place of the "breeze break ring" to avoid errors caused by drafts.

A side door can be opened and closed using the Door Control Lever, when the Door Joint is connected to a side door.

### Step Cards (A step card is attached to the balance)

<p><b>Response Adjustment</b></p> <p>With empty weighing pan, press and hold the  key for approx. two seconds.</p> <p><b>Keys</b></p> <p> Display on / off</p>	<p><b>Data Memory Function</b></p> <p><b>Setting</b></p> <p>Preparation for use. Press and hold the  key for approx. two seconds.</p> <p> Press the  key</p> <p> Press the  key</p> <p> Press the  key three times.</p> <p> Press the  key to select "1". Press the  key and then the  key</p> <p><b>Storing Data</b></p> <p>Pressing the  key, the weight value is stored in the balance.</p>	<p><b>Outputting</b></p> <p>Press and hold the  key for approx. two seconds.</p> <p>Press the  key</p> <p>Use the following keys.</p> <p> The key to output the display data.</p> <p> The key to select the next data.</p> <p> The key to select the previous data.</p> <p>Pressing the key two times, the balance returns to weighing mode.</p>
----------------------------------------------------------------------------------------------------------------------------------------------------------------	------------------------------------------------------------------------------------------------------------------------------------------------------------------------------------------------------------------------------------------------------------------------------------------------------------------------------------------------------------------------------------------------	--------------------------------------------------------------------------------------------------------------------------------------------------------------------------------------------------------------------------------------------------------------------------------------------------------------------------------------------------

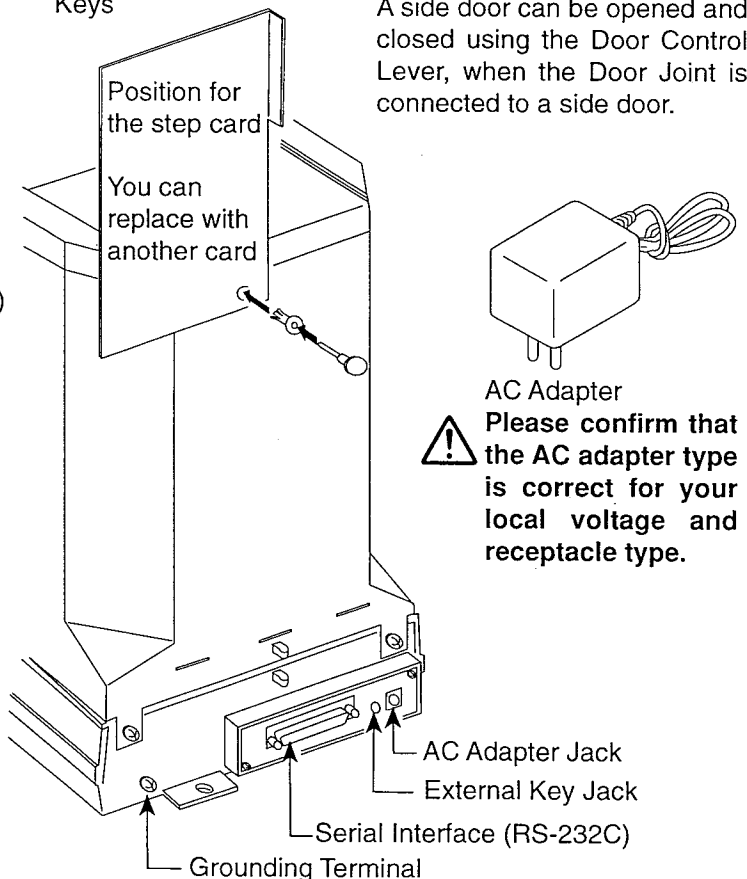



## Installing your Balance

- Step 1 Consider the section "2. Caution" for installing your balance. Place the balance on a firm weighing table.
- Step 2 Assemble the "Dust Plate", "Breeze Break Ring" and "Weighing Pan" on your balance. There is a reference illustration on the previous page.
- Step 3 Adjust the level of the balance using the leveling feet. Ground the balance chassis for discharging static electricity if you have a static problem.
- Step 4 Please confirm that the adapter type is correct for your local voltage and power receptacle type.
- Step 5 Connect the AC adapter to the balance. Warm up the balance for at least one hour with nothing on the weighing pan.
- Step 6 Calibrate the balance before use. (Refer to "7. Calibration")

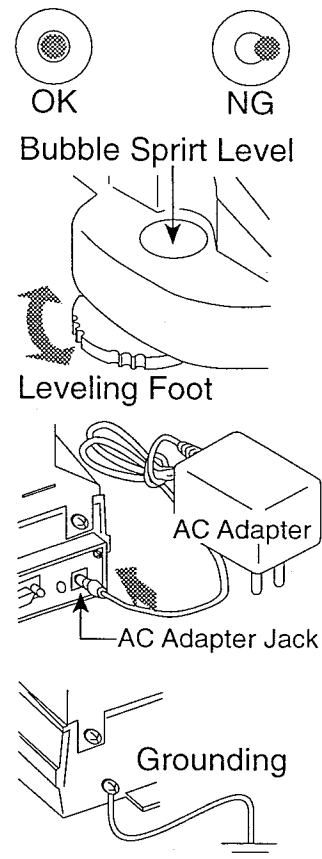

## Display Symbols and Key Operation

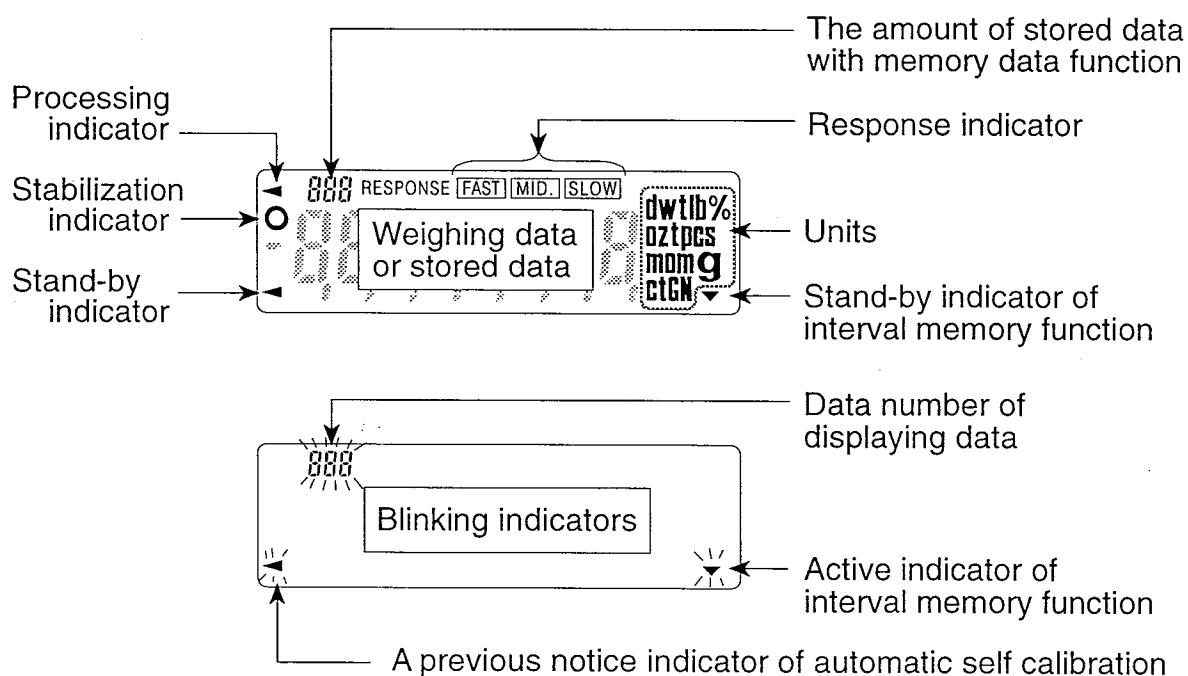

There are two operation types for pressing a key. Each key operation performs a different function.

First type : "Press and release the key immediately" or "Click the key"

Second type : "Press and hold the key"

The first type is "to press the key". the first type is normal key operation during measurement.

## Caution





Do not press and hold the key, if you do not perform a rewrite of the internal parameters.

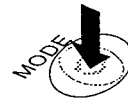

Press the key  
(Press and release the key immediately)

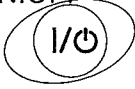
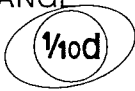

Press and hold the key

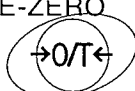
Key	Press the key	Press and hold the key
ON:OFF 	Display ON / OFF key. The stand-by indicator is displayed, when the balance is turned off with this key. Weighing data is displayed, when the balance is turned on with this key.	
RANGE 	Minimum figure of weighing data is changed.	The function table menu is displayed. Refer to section "9. Function table"
MODE 	Units are changed (selected from the function table). Refer to section "4. Weighing Units".	Response adjustment is performed.
CAL 	This key performs calibration of the balance using the internal weight.	Other items of the calibration menu are displayed.
PRINT 	Weighing data is stored in the balance (Factory setting) or is output to the RS-232C interface. This key functions according to the function table.	Data memory menu or GLP menu is displayed. This key functions according to the function table. Factory setting is "not used".
RE-ZERO 	The key sets the display to zero. This key returns a weighing value to the center of zero when the weighing pan is empty, and can also tare (cancel) the weight of container and/or sample. Please use this key before each weighing to cancel possible error.	



## 4. Weighing Units

The most common unit of weight used around the world is grams, but there is often a need to shift to an alternative unit specific to the country where the balance is used or to select modes such as counting or percent. The unit can be selected by the function table. The units are as follows (if some are missing please refer to your dealer):

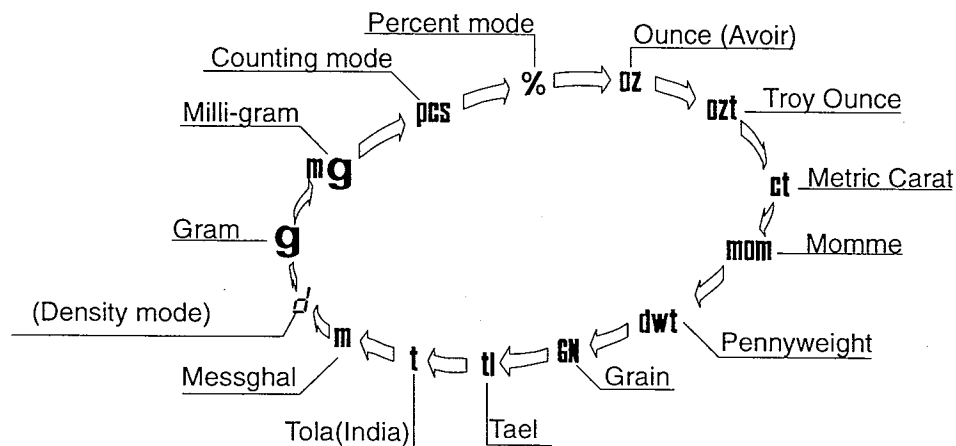

If a mode (or unit) of weight has been turned off, the sequence will be missing that mode or unit. There are also the various Tael that can be included if necessary. (Tael is selected as a unit from four units installed at the factory)

### Note

If the law in your area permits, you may use all of the units, or at this software level you can disable the weighing units you don't regularly use. Also, some dealers may initially turn OFF units which are not regularly used, but you may want to turn them back on.

### Conversion table

Abbrev.	Name	Conversion
mg	Milli-gram	0.001 g
oz	Ounce (Avoir)	28.349523125 g
ozt	Troy Ounce	31.1034768 g
ct	Metric Carat	0.2 g
mom	momme	3.75 g
dwt	Pennyweight	1.55517384 g
GN	Grain (UK)	0.06479891 g
TL	Tael (HK general, Sing.)	37.7994 g
TL	Tael (HK, jewelry)	37.429 g
TL	Tael (Taiwan)	37.5 g
TL	Tael (China)	31.25 g
t	Tola (India)	11.6638038 g
mes	Messghal	4.6875 g

## Operation of unit selection

The unit can be selected in the function table. The sequence of displaying the unit can be arranged so as to fit the frequency of use in the function table. According to the sequence of displaying unit, the units can be changed with the **MODE** key at the weighing mode.

### Selecting a unit and arranging the sequence of display

Step 1 Press and hold the **RANGE** key to display **h P S F n C** of the function table.

Step 2 Press the **RANGE** key several times to display **Unit**.

Step 3 Press the **PRINT** key to enter into unit selection.

Step 4 The unit can be selected using the following keys.

The unit display sequence is in the order of pressing the **RE-ZERO** key.

**MODE** key      The key to sequentially display the units.

**RE-ZERO** key      The key to select a unit. The  indicator is displayed at unit selected.

Step 5 Press the **PRINT** key to store the units. Then the balance displays next menu **id** of the function table.

Step 6 Press the **CAL** key to exit the function table. Then the balance returns to the weighing mode.



## 5. Weighing

### Cautions for the weighing operation

- Operate your balance gently.
- Press the **RE-ZERO** key to prevent possible error before placing material on the pan (weighing material) each time.
- Shorten the operation time as much as possible. ( Opening and closing door, placing and removing material)
- Temperature changes during measurement may cause weighing error.
- Use a pair of tweezers (pincette) to avoid a temperature change that is due to having your hand in the weighing chamber.
- Calibrate your balance periodically to maintain weighing accuracy. Refer to section "7.Calibration".
- Electrified material or magnetic body may cause a weighing error.
- Do not press keys with a sharp instrument (such as a pencil or ball point pen).
- Do not drop things on the pan, or place a weight on the pan that is beyond the weighing range of the balance.
- Keep the area clean and dry.
- Consider section "2. Caution" for weighing operation.



### Basic Operation (gram mode)

- Step 1 Calibrate your balance before use. (Refer to section "7. Calibration")
- Step 2 Place a container on the weighing pan, if necessary.  
Press the **RE-ZERO** key to cancel net weight. The balance displays zero.  
Container : A vessel placed on the pan, but not to be included in the weighing data.
- Step 3 Place material on the pan or in the container.
- Step 4 Wait for the stabilization indicator to be displayed and read the value.
- Step 5 Remove the material and container from the pan.



## Counting Mode (pcs)

### Selecting the counting mode

Step 1 Select the unit **pcs** using the **MODE** key. If the counting mode can not be selected, refer to section "4. Weighing Units". (**pcs** : pieces)

### Storing a unit weight

Step 2 Press the **RANGE** key to enter the sampling mode.

Step 3 If you want to select the number of items to be used for the sample, press the **RANGE** key (several times). It may be set to 10, 25, 50 or 100.

Step 4 Place a container on the weighing pan, if necessary. Press **RE-ZERO** key to cancel this weight.

ex. **10 0 pcs** is displayed in the case of 10 items.

Step 5 Place items on the pan. This number of items is the same quantity as the number displayed (10, 25, 50 or 100).

Step 6 Wait for the stabilization indicator to come on. Press the **PRINT** key to calculate the unit weight and store it.

### Counting items

Step 7 You are now able to count the items by placing them on the pan.

### Counting mode using the ACAI function

ACAI™ (Automatic Counting Accuracy Improvement) is a function that improves the accuracy of the unit weight.

Step 8 If you add a few more items, the ACAI indicator turns on. (The ACAI indicator turns off if in overload)

Step 9 The balance re-calculates the unit weight while the ACAI indicator is blinking. Wait and do not touch the items on the pan until the ACAI indicator turns off automatically.

Step 10 You are now able to count items with a more accurate unit weight.

Step 11 If you add a few more items, proceed to step 8. The balance re-calculates a more accurate unit weight.

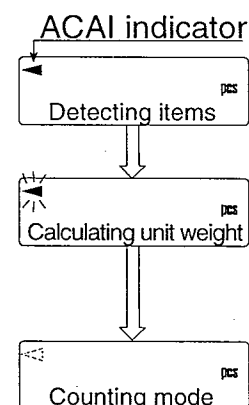



## Percent Mode (%)

### Selecting the unit of percent mode

Step 1 Select the unit [%] using the [MODE] key. If the percent mode can not be selected, refer to section "4. Weighing Units". (% : percent)

### Storing 100% weight

Step 2 Press the [RANGE] key to enter the sampling mode.

Step 3 Place a container on the weighing pan, if necessary.  
Press the [RE-ZERO] key to cancel the container weight and possible error. The balance displays [100 0 %].

Step 4 Place the item of 100% weight on the pan or in the container.

Step 5 Press the [PRINT] key to store this 100% weight.

Step 6 Remove the item from the pan.

### Reading percentage

Step 7 You are now able to read the percentage based on the stored 100% weight.





## 6. Response Adjustment

This function stabilizes the weight value, reducing the influence on weighing that is caused by drafts and/or vibration at the place where the balance is installed. This function adjusts by automatically analyzing the environment or by hand-operation. The function has three stages as follows :

Indicator	Function table	Summaries
FAST	[Cond 0]	Fast response, Sensitive value ↑ ↓
MID.	[Cond 1]	
SLOW	[Cond 2]	Slow response, Stable value

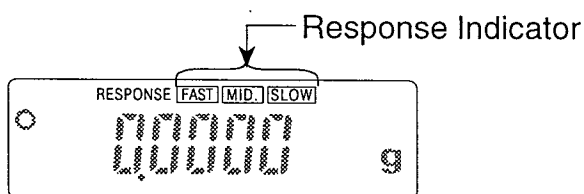

### Note

- ❑ If the automatic response adjustment is to awkward, Try to refine it using the section "Manual Response Adjustment".
- ❑ The response adjustment can be changed at "Condition ([Cond])" of "Environment & Display (bR5FnC)" in the function table. Refer to "9. Function table".



## Automatic Response Adjustment

This way automatically updates the response adjustment by analyzing the influence of the environment on the weight data.

### Operation

Step 1 Press and hold the [MODE] key until [RESPONSE] is displayed.

Step 2 The balance analyzes the influence and updates the response adjustment. If you want to cancel this update, press the [CAL] key.

### Caution

Do not allow vibration or drafts to affect the balance.

Step 3 The balance returns to the weighing mode automatically and displays the updated response indicator.

Press and hold the key.

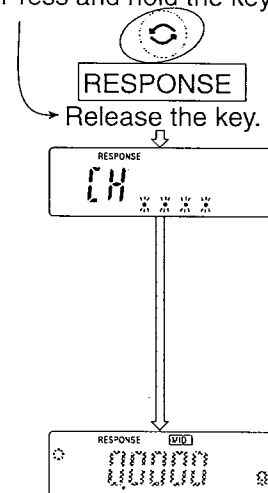



## Manual Response Adjustment

This way updates the response adjustment manually.

### Operation

- Step 1 Press and hold the **MODE** key until **RESPONSE** is displayed.  
Press the **MODE** key immediately.
- Step 2 Select a stage of the response adjustment using the **MODE** key. Either **FAST** or **MID.** or **SLOW** can be selected.
- Step 3 The balance automatically returns to the weighing mode after a few seconds of inactivity.



# 7. Calibration



## Calibration Group

The GR series has the following modes concerning calibration and calibration test.

- Automatic Self Calibration
- Calibration using the internal weight
- Calibration using an external weight
- Calibration test using the internal weight
- Calibration test using an external weight
- Correction of the internal weight value

### Note

- Calibration is controlled by the parameters of "Permission or prohibition". Refer to section "8. Function Switch and Initialization".
- The weight which can be used for calibration is called "the calibration weight". The weight which can be used for calibration test is called "the target weight". The weight which you have is called "the external weight".

### Caution

- This calibration achieves the adjustment for accurate weighing. It is necessary to perform calibration in the following case.
  - When the balance is installed for the first time.
  - When the balance has been moved.
  - When the ambient environment has changed.
  - For periodical calibration.
- Prevent vibration, drafts, and ambient temperature changes from the influence for the balance during calibration.
-  This indicator means "the balance is measuring calibration data". Do not allow vibration or drafts to affect the balance while this indicator is displayed.
- The data for GLP (Good Laboratory Practice) can be output using the RS-232C interface, when the "GLP output (*INF0*)" of "Data output (*dout*)" is set to "1" or "2". Refer to section "9. Function table".

### Caution using an External Weight

- The accuracy of an external weight can influence the accuracy of weighing.

Product	Usable external weight	Adjustable range
GR-120	100g, 50g	+15.9 mg ~ -15.0 mg
GR-200	200g, 100g	
GR-300	200g, 300g	
GR-202	200g, 100g	



## Automatic Self Calibration

This function automatically calibrates the balance, when the balance detects an ambient temperature change.

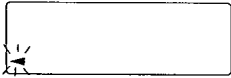

When the balance detects a change in ambient temperature, this indicator blinks and automatic self calibration is required. If the balance is not used for several minutes with this indicator blinking, the balance performs automatic self calibration. The environment will affect the time that the indicator blinks.



This display means "the balance is measuring calibration data". Do not allow vibration or drafts to affect the balance while this indicator is displayed.

### Advice

You can use the balance while the indicator blinks. But, it is recommended that to maintain the best accuracy, stop using the balance and confirm that there is nothing on the pan when the indicator starts blinking.

### Caution

- Do not place anything on the weighing pan during automatic calibration.

### Control of Automatic Self Calibration

Automatic self calibration is controlled by a parameter in "Permission or prohibition". Refer to section "8. Function Switch and Initialization"

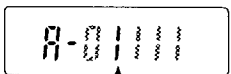

Automatic Self Calibration

0 : Not used

1 : Used



## Calibration Using the Internal Weight

This function calibrates the balance using the internal weight.

### Operation

- Step 1 Connect the AC adapter and warm up the balance for at least one hour with nothing on the weighing pan.
- Step 2 Press the **CAL** key to start calibration.
- Step 3 The balance displays **[CAL 1.0]** and performs calibration. Prevent vibration and drafts from affecting the balance.
- Step 4 If the "GLP output (1.0 F 0)" of the "Function Table" is set to "1" or "2", "Calibration Report" is output from RS-232C interface.
- Step 5 The balance will automatically return to the weighing mode after calibration.
- Step 6 Test the accuracy of weighing using the calibration test function or by using a certified test weight.

### Control of this Calibration

Calibration using the internal weight is controlled by a parameter in "Permission or prohibition". Refer to section "8. Function Switch and Initialization".

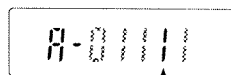

Calibration Using the Internal Mass

0 : Not used

1 : Used



# Calibration Test Using the Internal Weight

This function tests the balance accuracy using the internal weight.

## Operation

- Step 1 Connect the AC adapter and warm up the balance for at least one hour with nothing on the pan.
- Step 2 Press and hold the **CAL** key until displaying **[[ [ ]** and then release the key.
- Step 3 The balance measures the zero point.  
Prevent vibration and drafts to affect the balance.
- Step 4 The measured zero point data is displayed.
- Step 5 Ready for the internal weight measurement.
- Step 6 The balance measures the internal weight.  
Prevent vibration and drafts to affect the balance.
- Step 7 The internal weight data is displayed.
- Step 8 The balance informs you when the calibration test is finished. If the "GLP output ( [ ] [ ] )" of the "Function Table" is set to " 1 " or " 2 ", "Calibration Test Report" is output by the RS-232C interface.
- Step 9 The balance will automatically return to the weighing mode after the calibration test is finished.

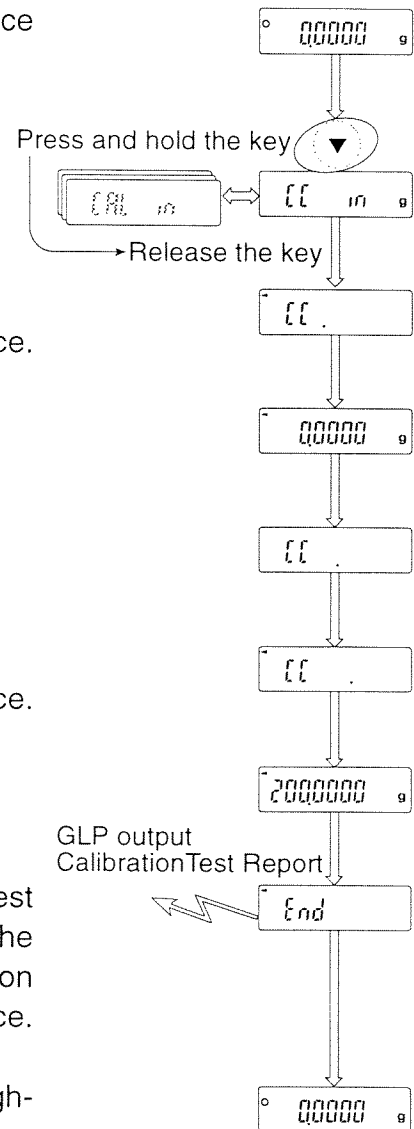



# Calibration Using an External Weight

This function calibrates the balance using an external weight. The weight to be used for calibration is called "the calibration weight". The weight which you have is called "the external weight".

## Operation

Step 1 Connect the AC adapter and warm up the balance for at least one hour with nothing on the pan.

Step 2 Press and hold the **CAL** key until displaying **[CAL out]** and then release the key.

Step 3 The balance displays **[CAL 0]**.  
 If you want to change the calibration weight value, proceed to step 4.  
 If you use the stored calibration weight value in the balance, proceed to step 5.

Step 4 Press the **RANGE** key and adjust the calibration weight value using the following keys.

- RE-ZERO** key The key to set the value of the digit selected.
- RANGE** key The key to select the digit to change value.
- PRINT** key The key to store a new weight value and return to step 3.
- CAL** key The key to cancel this change and return to step 3.

Product	Usable weight	Adjustable range
GR-120	100g, 50g	+15.9 mg ~ -15.0 mg
GR-200	200g, 100g	
GR-300	200g, 300g	
GR-202	200g, 100g	

**Note** Digits cyclically change using the **RE-ZERO** key.  
ex. 0mg→+15mg→-15mg→0mg

Step 5 Confirm that there is nothing on the pan and press the **PRINT** key. The balance measures the zero-point. Prevent vibration and drafts from affecting the balance.

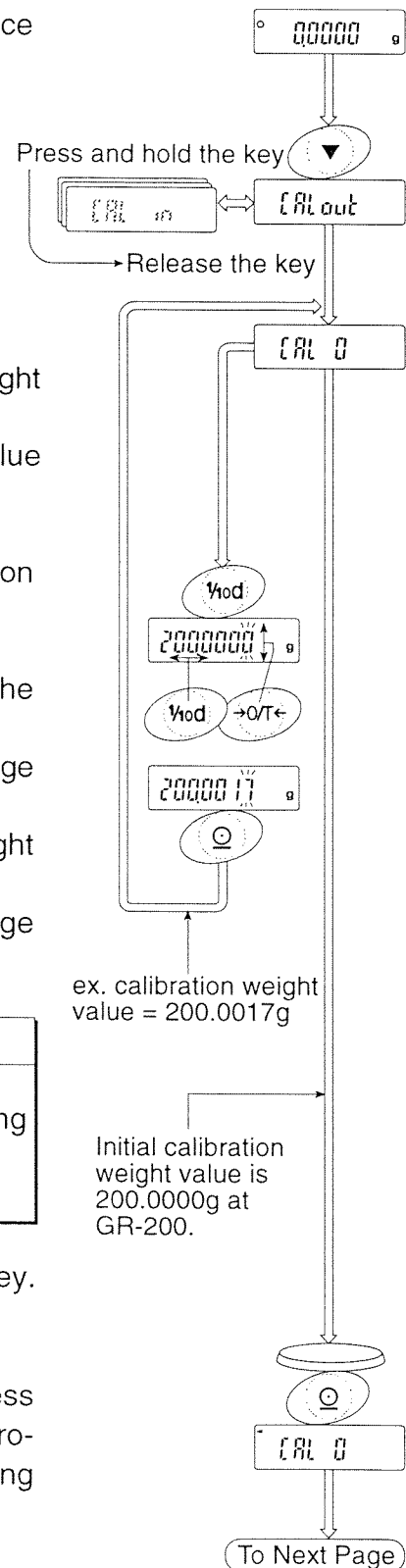

Step 6 Place the displayed calibration weight on the pan and press the **PRINT** key. The balance displays the measured calibration weight. Prevent vibration and drafts from affecting the balance.

Step 7 Remove the weight from the pan after the balance displays **End**.

Step 8 If the "GLP output ( *INF* )" of the "Function Table " is set to " *1* " or " *2* ", "Calibration Test Report" is output by the RS-232C interface.

Step 9 The balance will automatically return to the weighing mode after calibration.

Step 10 Test the accuracy of weighing using the calibration test function with a certified test weight.

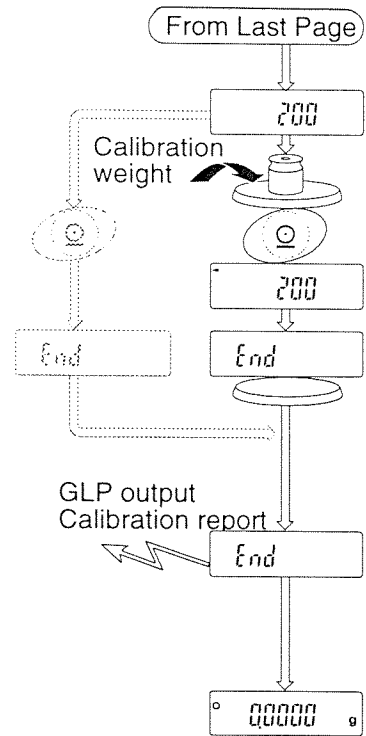

### Control of this Calibration

Calibration using an external weight is controlled by a parameter in "Permission or prohibition". Refer to section "8. Function Switch and Initialization"

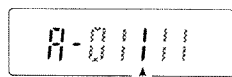

Calibration Using the External Mass  
 0 : Not used  
 1 : Used





# Calibration Test Using an External Weight

This function tests the balance for the accuracy using an external weight. A weight which is used for the calibration test is called "the target weight". The weight which you have is called "the external weight".

## Operation

Step 1 Connect the AC adapter and warm up the balance for at least one hour with nothing on the pan.

Step 2 Press and hold the **CAL** key until displaying **[[ out** and then release the key.

Step 3 The balance displays **[[ 0**.  
 If you want to change the target weight value, proceed to step 4.  
 If you use the stored target weight value in the balance, proceed to step 5.

Step 4 Press the **RANGE** key and adjust the calibration weight value using the following keys.

- RE-ZERO** key The key to set the value of the digit selected.
- RANGE** key The key to select the digit to change value.
- PRINT** key The key to store a new weight value and return to step 3.
- CAL** key The key to cancel this change and return to step 3.

Product	Usable weight	Adjustable range
GR-120	100g, 50g	+15.9 mg ~ -15.0 mg
GR-200	200g, 100g	
GR-300	200g, 300g	
GR-202	200g, 100g	

**Note** Digits cyclically change using the **RE-ZERO** key.  
ex. 0mg→+15mg→-15mg→0mg

Step 5 Confirm that there is nothing on the pan and press the **PRINT** key. The balance measures the zero-point and displays it. Prevent vibration and drafts from affecting the balance.

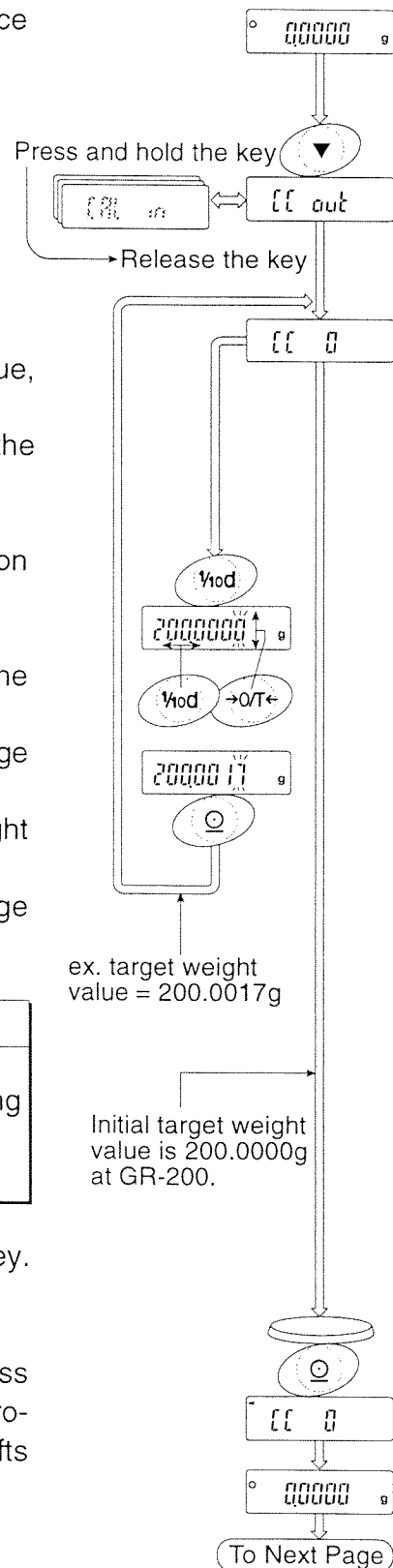

Step 6 Place the displayed target weight on the pan and press the **PRINT** key. The balance displays the measured target weight and displays it. Prevent vibration and drafts from affecting the balance.

Step 7 Remove the weight from the pan after the balance displays **End**.

Step 8 If the "GLP output ( *inFd* )" of the "Function Table " is set to " *1*" or " *2*", "Calibration Test Report" is output by the RS-232C interface.

Step 9 The balance will automatically return to the weighing mode after calibration.

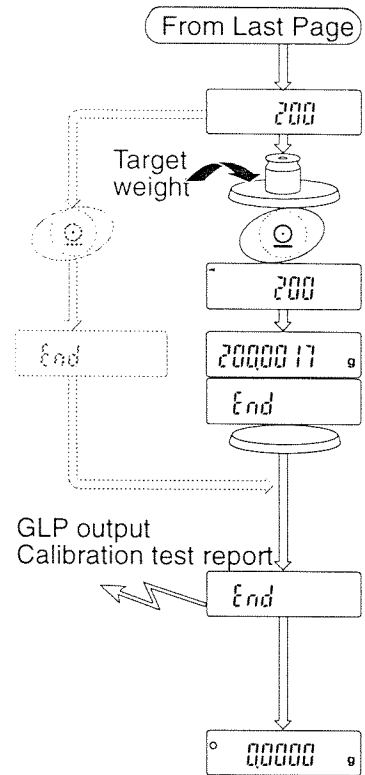



# Correcting the Internal Weight Value

The GR series can correct the internal weight value within  $\pm 1.5$  mg. The initial internal weight value of the GR-120 is 100.0000 g. The initial internal weight value of the GR-200, GR-300 and GR-202 is 200.0000 g.

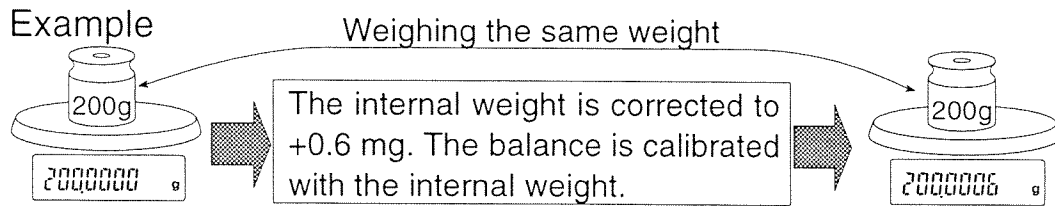

## Operation

Step 1 Turn off the display using the **ON:OFF** key.

Step 2 Press the **ON:OFF** key while the **RANGE** key and **PRINT** key are pressed and held. Then the balance displays **P5**.

Step 3 Press the **PRINT** key. Then the balance displays the switches.

Step 4 Set the following switches to " /".

**RE-ZERO** key The key to select the setting of the switch.

**RANGE** key The key to select the switch to change the setting.

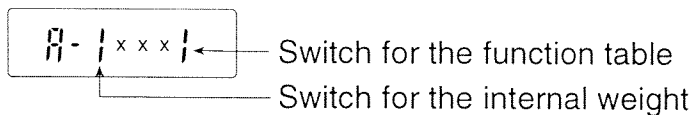

Step 5 Press the **PRINT** key to store the new setting. The balance will return to the weighing mode.

Step 6 Press and hold the **RANGE** key to enter the function table and release the key when **bR5Fnc** is displayed.

Step 7 Press the **RANGE** key several times to display **[5 in**.

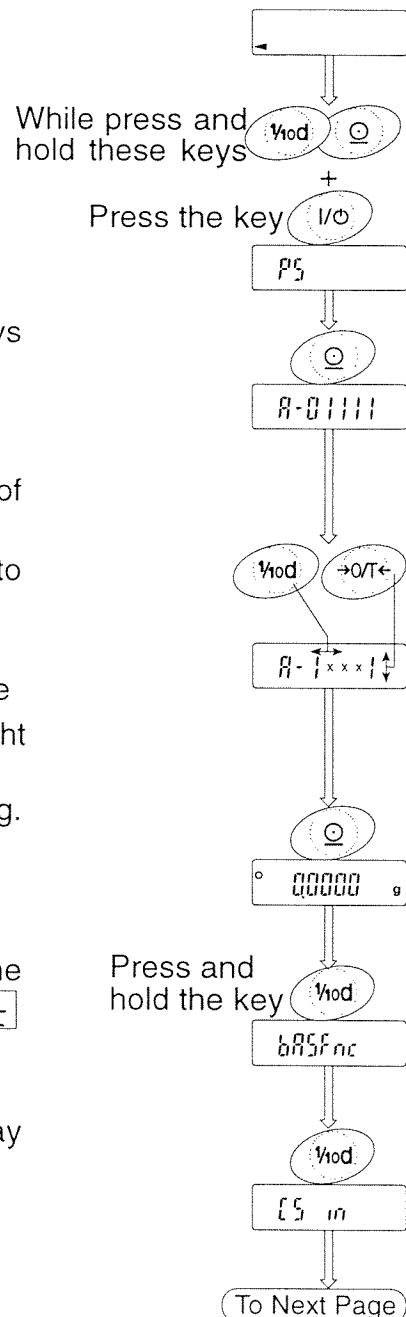

Step 8 Press the **PRINT** key to enter into the procedure for correcting the internal weight value.

Step 9 Correct the internal weight value using the following keys.

- RE-ZERO** key The value is selected.  
(+1.5 mg ~ -1.5 mg)
- PRINT** key The new value is stored and **1d** is displayed.
- CAL** key This correction is canceled and **1d** is displayed.

Step 9 Press the **CAL** key. The balance will return to the weighing mode.

Step 9 Press the **CAL** key to calibrate the balance.

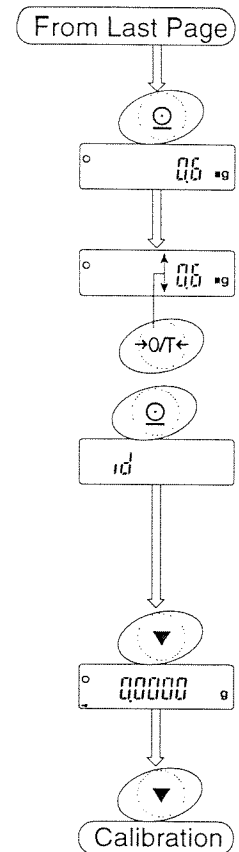

### Control of the Correction

Correction of the internal weight value is controlled by the parameters in "Permission or prohibition". Refer to section "8. Function Switch and Initialization"

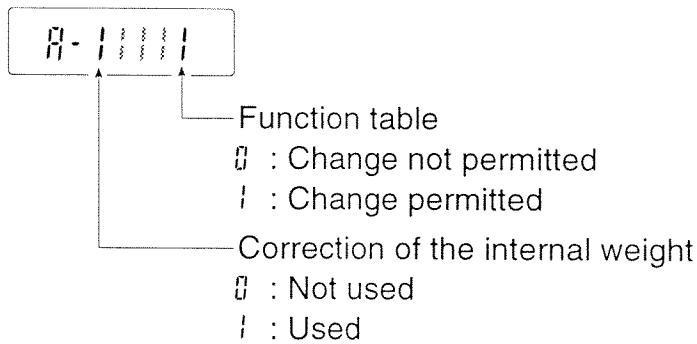



## 8. Function Switch and Initialization



### Permission or Prohibition

The balance stores parameters that must not be changed carelessly (ex. Calibration data for precision weighing, Data for adapting to environment, Control data for RS-232C interface, etc.). There are five switches for the purpose of preserving these parameters. Each switch can select either "permission" or "prohibition". The "prohibition" protects careless operation.

#### Switches

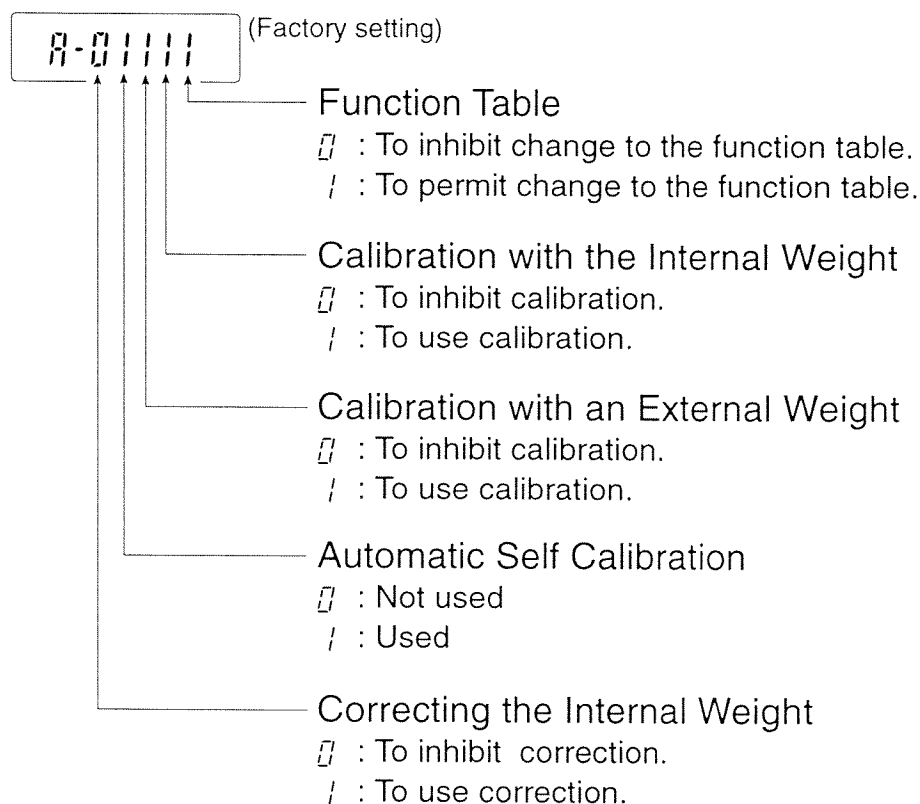

#### Operation

Step 1 Turn off the display using the **ON:OFF** key.

Step 2 Press the **ON:OFF** key while the **RANGE** key and **PRINT** key are pressed and held. Then the balance displays **F5**.

Step 3 Press the **PRINT** key. Then the balance displays the switch settings.

Step 4 Set the switches using the following keys.

**RE-ZERO** key The key to change the setting of the switch.

**RANGE** key The key to select the switch to change the setting.

**PRINT** key The key to store the new setting.

**CAL** key The key to cancel this operation.



## Initializing the Balance

This function returns the following parameters to factory settings.

- Calibration data.
- Function table.
- The 100% weight
- The data that is stored in the balance using data memory function.
- External calibration weight and target weight.
- Switch settings for "Permission or prohibition".

### Operation

Step 1 Turn off the display.

Step 2 Press the **ON:OFF** key while the **RANGE** key and **PRINT** key are pressed and held. Then the balance displays **PS**.

Step 3 Press the **RANGE** key to display **LLr**.

Step 4 Press the **PRINT** key. (If you want to cancel this operation, press the **CAL** key)

Step 5 Press the **RE-ZERO** key.

Step 6 Press the **PRINT** key to initialize the balance. The balance will automatically return to weighing mode.

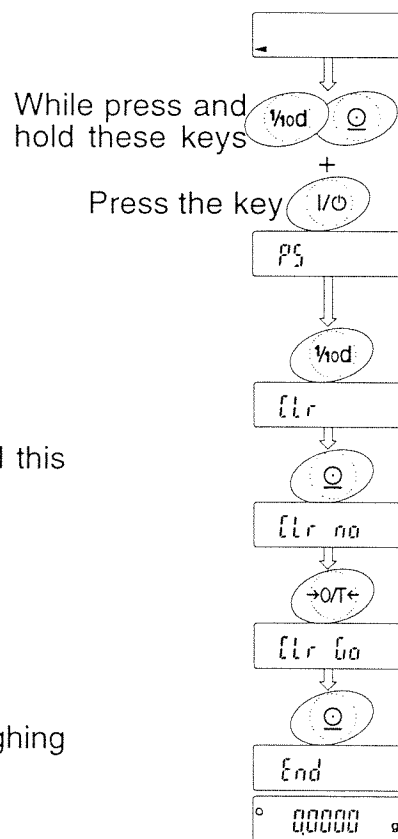



# 9. Function Table

The operation of the "Function Table" is to read or rewrite the parameters that are stored in the balance. These parameters are stored until the next change even without power applied.

## Caution

The balance may not work effectively when a combination of parameters and environment are not proper. Confirm the parameter before changing it.

## Structure and Sequence of the Function Table

The function table menu consists of two layers. The first layer is the "Class" and second layer is the "Item". Each Item stores a parameter. The effective parameter is the last parameter that is displayed in the sequence. New parameters operate upon the balance after pressing the **PRINT** key.

## Example

This example sets "use" to "Data memory" and "every minute" to "Interval time".

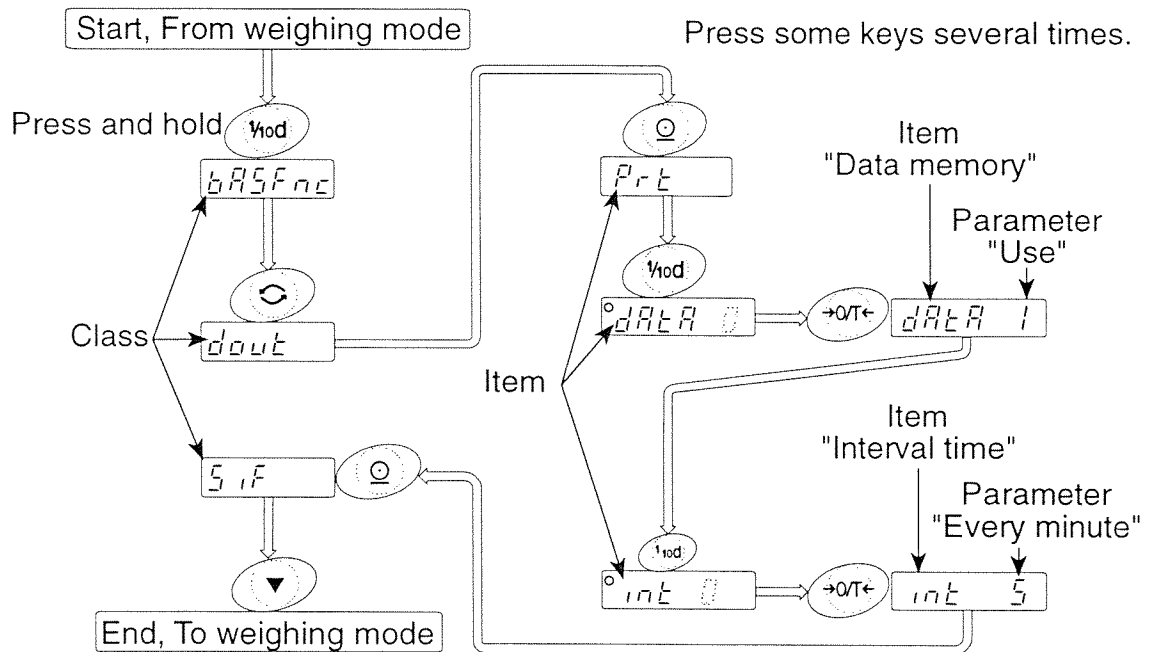

## Control of this Function Table

The function table is controlled by a parameter in "Permission or prohibition". Refer to section "8. Function Switch and Initialization"

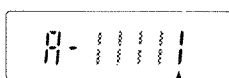

Function table

0 : Change not permitted

1 : Change permitted



## Display and Keys of the Function Table

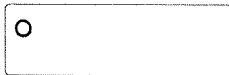

The "o" symbol is displayed at a selected parameter.

RANGE

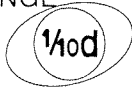

When the key is pressed and held in weighing mode, the balance enters the "function table mode".

The key to change the class or item in the function table mode.

RE-ZERO



The key to select the parameter, when the balance displays an item.

PRINT



The key to move to an item from the class, when the balance displays a class.

The key to store new parameters and display the next class, when the balance displays an item.

CAL

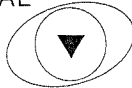

The key to cancel new parameters and display the next class, when the balance displays an item.

The key to exit the function table mode, when the balance displays a class.





## Details of the Function Table

Class	Item	Parameter	Summaries	
bA5FnC Environment, Display	Cond Condition	0	Fast response, Sensitive value	Common data of "Response adjustment".
		• 1	Slow response and stable value	
	St-b Stability band width	0	Stable when within $\pm 1$ digit	The stability indicator lights when the display fluctuation is within the range per second.
		• 1	Stable when within $\pm 3$ digit	
	Zrc Zero tracking	0	OFF	The function to keep zero display by tracking zero-drift.
		• 1	ON	
	SPd Display update rate	• 0	Normal, 5 times/second	The period to refresh the display.
1		Fast, 10 times/second		
Pnt Decimal point	• 0	Point (.)	The form of decimal point.	
	1	Comma (,)		
P-on Automatic start	• 0	OFF	Connecting adaptor, the display turns on without key operation.	
	1	ON		
dout Data output	Prt Data output mode	• 0	Key mode	Data is output or stored with PRINT key and stability indicator.
		1	Auto-print mode A (Standard value is zero)	Data is output or stored when the display value is stable and meets the conditions of RP-P, RP-b and standard value.
		2	Auto-print mode B (Standard value is last stable value)	
		3	Stream mode / Interval memory mode	In case of dRA 0, Data is output continuously. In case of dRA 1, Data memory function is used.
	RP-P Auto-print polarity for mode A or B	• 0	Plus polarity	Display value $\geq$ Standard value
		1	Minus polarity	Standard value $>$ Display value
		2	Both polarities (Absolute value)	Display value $\geq$ Standard value or Standard value $>$ Display value
	RP-b Auto-print difference for mode A or B	0	10 digit	Difference between standard value and display value
		• 1	100 digit	
		2	1000 digit	
	dRA Data memory function	• 0	Not used	Relation : Prt, int, d-on
		1	Use	
	int Interval time for Data memory function	• 0	Every Measurement	Interval time is selected on Prt 3, dRA 1.
1		Every 2 seconds		
2		Every 5 seconds		
3		Every 10 seconds		
4		Every 30 seconds		
5		Every 1 minute		
6		Every 2 minutes		
7		Every 5 minutes		
8	Every 10 minutes			

• : factory setting. \* : "Digit" is the unit of minimum display.

Class	Item	Parameter	Summaries		
<i>dout</i> Data output	<i>d-no</i> Data number output	• 0	No output	Refer to section "11. Data memory function".	
		1	Output		
	<i>PUSE</i> Data pause	• 0	No pause	Selection of output interval.	
		1	Pause (1.5 second)		
	<i>AE-F</i> Auto feed	• 0	Not used	Selection of paper feed after printing.	
		1	Use		
<i>inFd</i> GLP output		• 0	No output	The type of GLP data output	
		1	AD-8121 format		
		2	Data format		
<i>Ar-d</i> Zero after output		• 0	Not used		
		1	Use		
<i>SIF</i> Serial Interface	<i>bPS</i> baud rate	0	600 bps		
		1	1200 bps		
		• 2	2400 bps		
		3	4800 bps		
		4	9600 bps		
	<i>btPr</i> Length, Parity bit		• 0	7 bits, even parity check	
			1	7 bits, odd parity check	
			2	8 bits, no parity check	
	<i>Cr-LF</i> Terminator		• 0	CR LF	CR : ASCII code 0Dh LF : ASCII code 0Ah
			1	CR	
	<i>tYPE</i> Data format		• 0	A&D standard format	Refer to section "Explanation of data format"
			1	DP format	
			2	KF format	
			3	MT format	
4			NU format		
<i>t-UP</i> Receive time		0	No limit	Waiting time during a command.	
		• 1	For one second		
<i>ErEd</i> <AK> and error code		• 0	No output	AK : ASCII code 06h	
		1	Output		
<i>ctS</i> CTS control		• 0	Not used	Keep the RTS line (active) high while the computer receives data CTS low will be set if it is busy.	
		1	Using CTS and RTS		
<i>dS Fnc</i> Specific gravity measuring mode	<i>Ld in</i> Liquid density	• 0	Enter the water temperature.	Available only when the specific gravity measuring mode is selected. Refer to section "13. Specific gravity (density) measurement".	
		1	Enter the density directly.		
<i>Unit</i> Unit			Refer to section "4. Weighing Units"		
<i>CS in</i> Correction of internal weight			Refer to section "7. Calibration"		
<i>id</i> ID number			Refer to section "10. ID number and GLP"		

• : factory setting.

## Caution

When the baud rate is set to 2400bps or less, the output rate is slower than the display update rate and the balance may not transmit the data completely (and transmits it intermittently).



## Explanation of Item "Environment, Display"

### Condition ( $Cond$ )

$Cond \ 0$  This parameter is for sensitive response to the fluctuation of a weight value. Use for target weighing of powder, weighing of a very light sample or weighing requiring quick response.



$Cond \ 1$  This parameter is for stable weighing with slow response. Use to prevent a weight value from drifting depended on the balance location.

### Stability band width ( $St-b$ )

This item controls the width to regard a weight value as a stable value. When the fluctuation per second is less than this parameter, the balance displays the stability indicator and outputs or stores the data. This parameter influences the "Auto-print mode"

$St-b \ 0$  This parameter is for sensitive response of the stability indicator. Use for exact weighing.



$St-b \ 1$  This parameter ignores slight fluctuation of a weight value. Use to prevent the weight value from drifting.

### Zero tracking ( $Trc$ )

This function traces zero point drift and keeps a zero display automatically, when the weighing value drifts due to changes in the environment.

$Trc \ 0$  The tracking function is not being used. Use for weighing of a very light sample.



$Trc \ 1$  The tracking function is used.

### Display update rate ( $SPd$ )

The display update rate influences "Baud rate", "Data pause" and "Stream mode".

### Decimal point ( $Pnt$ )

The decimal point form can be selected.

### Automatic start ( $P-on$ )

When the AC adapter is connected, weighing is automatically started without key operation. Use for a built-in balance in a system. Warm-up for at least one hour is necessary for accurate weighing.



## Explanation of Item "Data output mode"

The **PRINT** key can be used at any time for transmitting data.

### Key Mode

When you press the **PRINT** key and the display value is stable, the balance outputs the weighing data and the display blinks one time.

Required setting    *dout*        *Prt 0*        Print key mode

### Auto-Print Mode A

When the display value is stable and meets the conditions of "Auto-print polarity", "Auto-print band" and standard value (of zero point), the balance outputs the weighing data. If you press the **PRINT** key, the balance outputs the data and the display blinks one time.

Required setting    *dout*        *Prt 1*        Auto-print mode A  
                          *dout*        *AP-P*        Auto-print polarity  
                          *dout*        *AP-b*        Auto-print band

Example             "Weighing and removing one item."

### Auto-Print Mode B

When the display value is stable and meets the conditions of "Auto-print polarity", "Auto-print band" and standard value (of last stable value), the balance outputs the weighing data. If you press the **PRINT** key, the balance outputs the data and the display blinks one time.

Required setting    *dout*        *Prt 2*        Auto-print mode B  
                          *dout*        *AP-P*        Auto-print polarity  
                          *dout*        *AP-b*        Auto-print band

Example             "Transmitting the data of each operation."

### Stream Mode

The balance outputs the weighing data continuously.

Required setting    *dout*        *Prt 3*        Stream mode  
                          *dout*        *dMEM 0*      Data memory function is not used.  
                          *bASSFnc*    *SPd*        Display update rate  
                          *SIF*        *bPS*        Baud rate

Example             "Monitoring data on a computer"

### Caution

When the baud rate is set to 2400bps or less, the display update rate is faster than the output rate and the balance may not transmit the data completely (and transmits it intermittently).

## Interval Memory Mode

This is the data memory function mode. Weighing data is periodically stored in the balance. The interval memory mode can not be used, while stream mode is used.

Required setting    *dout*            *prt 3*            Stream mode  
                          *dout*            *DATA 1*          Data memory function is used.  
                          *dout*            *int*                Interval time

Example                "Periodical weighing without computer command and outputting all of the data to a computer at one time"

## Explanation of Item "Data format"

### A&D standard format

*SIF TYPE 0*

This format is used when the peripheral equipment is capable of receiving A&D format. If an AD-8121 is used, set the printer to mode 1 or 2.

- This format consists of fifteen characters (excluding the terminator).
- A header of two characters indicates the status of the stability.
- The plus sign is placed before the data, when the data is zero or positive.
- The weight data uses leading zeros.
- The unit has three characters.

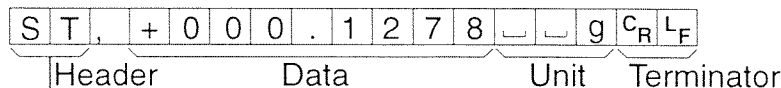

- |   |   |
|---|---|
| S | T |
|---|---|

 Stable header
- |   |   |
|---|---|
| U | S |
|---|---|

 Unstable header
- |   |   |
|---|---|
| O | L |
|---|---|

 Overload header
- |   |   |
|---|---|
| Q | T |
|---|---|

 Stable header for counting mode

### D.P. (Dump print) format

*SIF TYPE 1*

This format is used when the peripheral equipment can not process the A&D format. If an AD-8121 is used, set the printer to mode 3.

- This format consists of sixteen characters (excluding the terminator).
- A header of two characters indicates the status of the stability without overload.
- The polarity sign is placed before data, if not zero or overloaded.
- The weight data has spaces in place of the leading zeros.
- The unit has three characters.

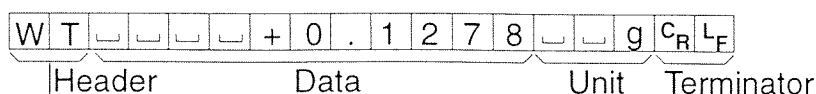

- |   |   |
|---|---|
| W | T |
|---|---|

 Stable header
- |   |   |
|---|---|
| U | S |
|---|---|

 Unstable header
- |   |   |
|---|---|
| Q | T |
|---|---|

 Stable header for counting mode

## KF format

SIF TYPE 2

This is the Karl-Fischer moisture meter format, and is used when the peripheral equipment can only communicate using this format.

- This format consists of fourteen characters (excluding the terminator).
- This format has no header characters.
- The polarity sign is first, if not zero or overloaded.
- The weight data uses spaces in place of leading zeros.
- This format outputs the unit "g" only for a stable value.

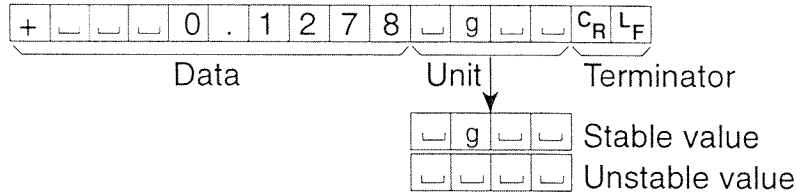

## MT format

SIF TYPE 3

- This format has a two character header.
- The polarity sign is used only for negative data.
- The weight data uses spaces in place of the leading zeros.
- The character length of this format changes dependent upon the unit.

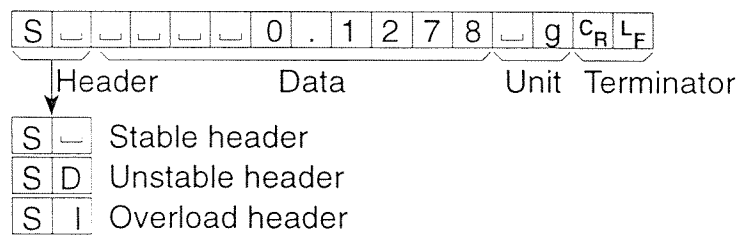

## NU (numerical) format

SIF TYPE 4

This format has only numerical data.

- This format consists of nine characters (excluding the terminator).
- The polarity sign is first.
- The weight data uses leading zeros.

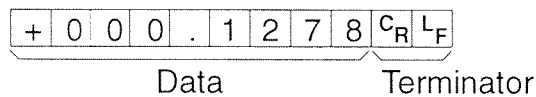

## Data number format

data d-no 1

This data number format is output just before data is transmitted to the RS-232C interface.

- This format consists of six characters (excluding the terminator).

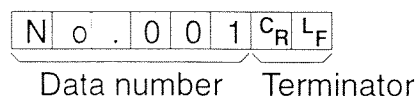



# Examples of data format

## Stable

° 0.1278 g

A&D	S	T	,	+	0	0	0	.	1	2	7	8			g	C <sub>R</sub>	L <sub>F</sub>	
D.P.	W	T						+	0	.	1	2	7	8			g	C <sub>R</sub> L <sub>F</sub>
KF	+				0	.	1	2	7	8			g			C <sub>R</sub>	L <sub>F</sub>	
MT	S						0	.	1	2	7	8			g	C <sub>R</sub>	L <sub>F</sub>	
NU	+	0	0	0	.	1	2	7	8							C <sub>R</sub>	L <sub>F</sub>	

## Unstable

- 18.3690 g

A&D	U	S	,	-	0	1	8	.	3	6	9	0			g	C <sub>R</sub>	L <sub>F</sub>		
DP	U	S						-	1	8	.	3	6	9	0			g	C <sub>R</sub> L <sub>F</sub>
KF	-				1	8	.	3	6	9	0						C <sub>R</sub>	L <sub>F</sub>	
MT	S	D						-	1	8	.	3	6	9	0			g	C <sub>R</sub> L <sub>F</sub>
NU	-	0	1	8	.	3	6	9	0								C <sub>R</sub>	L <sub>F</sub>	

## Overload

Positive error

E

A&D	O	L	,	+	9	9	9	9	9	9	9	9	E	+	1	9	C <sub>R</sub>	L <sub>F</sub>
DP													E					C <sub>R</sub> L <sub>F</sub>
KF										H								C <sub>R</sub> L <sub>F</sub>
MT	S	I	+															C <sub>R</sub> L <sub>F</sub>
NU	+	9	9	9	9	9	9	9	9									C <sub>R</sub> L <sub>F</sub>

Negative error

-E

A&D	O	L	,	-	9	9	9	9	9	9	9	9	E	+	1	9	C <sub>R</sub>	L <sub>F</sub>
DP													E					C <sub>R</sub> L <sub>F</sub>
KF										L								C <sub>R</sub> L <sub>F</sub>
MT	S	I	-															C <sub>R</sub> L <sub>F</sub>
NU	-	9	9	9	9	9	9	9	9									C <sub>R</sub> L <sub>F</sub>

## Data number

N o . 0 0 1 C<sub>R</sub> L<sub>F</sub>

S T , + 0 0 0 . 1 2 7 8 g C<sub>R</sub> L<sub>F</sub>

- ␣ Space, ASCII 20h
- C<sub>R</sub> Carriage Return, ASCII 0Dh
- L<sub>F</sub> Line Feed, ASCII 0Ah

# Units

	Symbol	A&D	D.P.	KF	MT
Gram mode	<b>g</b>	┌┌g	┌┌g	┌g┌┌	┌g
Milligram mode	<b>mg</b>	┌mg	┌mg	┌mg┌	mg
Counting mode	<b>pcs</b>	┌PC	┌PC	┌p c s	┌P C S
Precent mode	<b>%</b>	┌┌%	┌┌%	┌%┌┌	┌%
Ounce (Avoir)	<b>oz</b>	┌o z	┌o z	┌o z┌	┌o z
Troy Ounce	<b>ozt</b>	o z t	o z t	┌o z t	┌o z t
Metric Carat	<b>ct</b>	┌c t	┌c t	┌c t┌	┌c t
Momme	<b>mom</b>	m o m	m o m	┌m o m	┌m o
Pennyweight	<b>dwt</b>	d w t	d w t	┌d w t	┌d w t
Grain	<b>GN</b>	┌GN	┌GN	┌g r┌	┌GN
Tael (HK general,Sing.)	<b>tl</b>	┌TL	┌TL	┌t 1 s	┌t 1
Tael (HK, jewelry)	<b>tl</b>	┌TL	┌TL	┌t 1 h	┌t 1
Tael (China)	<b>tl</b>	┌TL	┌TL	┌t 1 t	┌t 1
Tael (Taiwan)	<b>tl</b>	┌TL	┌TL	┌t 1 c	┌t 1
Tola (India)	<b>t</b>	┌┌t	┌┌t	┌t o 1	┌t
Messghal	<b>m</b>	m e s	m e s	┌M S┌	┌m
Density		┌D S	┌D S	┌D S┌	┌D S
┌ Space, ASCII 20h					





## 10. The ID Number, GLP Report

- ❑ The ID number is used to identify the balance when Good Laboratory Practice (GLP) is used.
- ❑ The ID number is output on the "Calibration Report", "Calibration Test Report" and "Title block".
- ❑ The GLP output format is selected at the "GLP output (INFQ)" of the "Function Table".
- ❑ The balance can output the following reports for GLP.
  - "Calibration Report" of the calibration using the internal weight.
  - "Calibration Report" of the calibration using an external weight.
  - "Calibration Test Report" of the calibration using the internal weight.
  - "Calibration Test Report" of the calibration using an external weight.
  - "Title block" and "End block" for weighing data.



### Setting of the ID Number

Step 1 Press and hold the **RANGE** key to display **hR5FnC**.

Step 2 Press the **RANGE** key several times to display **id**.

Step 3 Press the **PRINT** key. You can to set the ID number using the following keys.

**RANGE** key The key to increment the digit.

**RE-ZERO** key The key to select the character of the digit. Refer to the following table for the "Display Character Set".

**PRINT** key The key to store a new ID number and proceed to the next class of the function table.

**CAL** key The key to cancel the new ID number and proceed to the next class of the function table.

Step 4 Press the **CAL** key to return to the weighing mode.

#### Display Character Set

0	1	2	3	4	5	6	7	8	9	-	_	A	B	C	D	E	F	G	H	I	J	K	L	M	N	O	P	Q	R	S	T	U	V	W	X	Y	Z
0	1	2	3	4	5	6	7	8	9	-	_	A	B	C	d	E	F	G	H	i	J	K	L	M	N	O	P	Q	R	S	T	U	V	W	X	Y	Z

↵ Space



## GLP output

- Set the following parameters to output the report.
- ❑ If the report is printed, set the "GLP output ( *inf 0* )" to "1". The AD-8121 printer is used in this explanation. Refer to "14. Connection to the AD-8121". The AD-8121 uses MODE 3.
- ❑ The report is output to the RS-232C interface of a computer, set the "GLP output ( *inf 0* )" to "2".

## Calibration report using the internal weight

### Key operation

- Step 1 Press the **CAL** key to display **[CAL 11]**. The balance calibrates automatically.
- Step 2 If the calibration report is output, **[GLP]** is displayed and the GLP data is output.
- Step 3 The balance returns to the normal weighing mode automatically.

### AD-8121 format

*inf 0 1*

```

          A & D
MODEL      GR-200
S/N        12345678
ID         ABCDEFGH
DATE       98/04/08
04:47:40 PM
CALIBRATED<INT.>
SIGNATURE
-----

```

← Factory →

← Product →

← Serial number →

← ID number →

← Date →

← Time →

← Calibration type →

← Signature →

### Data format

*inf 0 2*

```

          A & D<TERM>
MODEL      GR-200<TERM>
S/N        12345678<TERM>
ID         ABCDEFGH<TERM>
DATE<TERM>
<TERM>
TIME<TERM>
<TERM>
CALIBRATED<INT.><TERM>
SIGNATURE<TERM>
<TERM>
<TERM>
-----<TERM>
<TERM>
<TERM>

```

- ␣ Space mark, ASCII 20H.
- <TERM> Terminator mark,  $C_R$   $L_F$  or  $C_R$ .
- $C_R$  Carriage return mark, ASCII 0DH
- $L_F$  Line feed mark, ASCII 0AH

Example of GR-200

# Calibration test report using the internal weight

## Key operation

- Step 1 Press and hold the **CAL** key until displaying **[[ [ ] ]]**. Release the key.
- Step 2 The balance displays **[[ [ ] ]]** and performs the calibration test automatically.
- Step 3 The zero point is measured and this value is displayed.
- Step 4 The internal weight is measured and this value is displayed.
- Step 5 If the calibration test report is output , **[[ [ ] ]]** is displayed and the GLP data is output.
- Step 6 The balance returns to the weighing mode automatically.

## Command operation

- Step 1 Transmit the **TST** command to the balance.
- Step 2 The balance performs the calibration test automatically.
- Step 3 If the calibration test report is output, the GLP data is output.
- Step 4 The balance returns to the weighing mode automatically.

AD-8121 format

*info 1*

```

          A & D
MODEL    GR-200
S/N      12345678
ID       ABCDEFGH
DATE     98/04/08
05:21:42 PM
CAL.TEST(INT.)
ACTUAL
          0.0000 g
          +200.0002 g
TARGET
          +200.0000 g
SIGNATURE
-----
  
```

- └ Space mark, ASCII 20H.
- <TERM> Terminator mark, C<sub>R</sub> L<sub>F</sub> or C<sub>R</sub>.
- C<sub>R</sub> Carriage return mark, ASCII 0DH
- L<sub>F</sub> Line feed mark, ASCII 0AH

Data format

*info 2*

```

          A & D<TERM>
MODEL    GR-200<TERM>
S/N      12345678<TERM>
ID       ABCDEFGH<TERM>
DATE<TERM>
<TERM>
TIME<TERM>
<TERM>
CAL.TEST(INT.)<TERM>
ACTUAL<TERM>
          0.0000 g<TERM>
          +200.0002 g<TERM>
TARGET<TERM>
          +200.0000 g<TERM>
SIGNATURE<TERM>
<TERM>
<TERM>
-----<TERM>
<TERM>
<TERM>
  
```

Example of GR-200

# Calibration Report using an external weight

## Key operation

- Step 1 Press and hold the **CAL** key until displaying **[CAL out]**. Release the key.
- Step 2 The balance displays **[CAL 0]**.
- If you want to change the calibration weight value, proceed to step 3.
  - If you use the stored calibration weight value in the balance, proceed to step 4.
- Step 3 Press the **RANGE** key and adjust calibration weight using the following keys.
- RE-ZERO** key The key to set the value of the digit selected.
  - RANGE** key The key to select the digit to change value.
  - PRINT** key The key to store a new weight value and return to step 2.
  - CAL** key The key to cancel this change and return to step 2.
- Step 4 Press the **PRINT** key. The zero point is measured and this value is displayed.
- Step 5 Place the calibration weight on the pan and press the **PRINT** key. The weight is measured and this value is displayed.
- Step 6 Remove the weight after **[End]** is displayed.
- Step 7 If the calibration report is output, **[GLP]** is displayed and the GLP data is output.
- Step 8 The balance returns to the weighing mode automatically.

### AD-8121 format

```

inf 1
      A & D
MODEL    GR-200
S/N      12345678
ID        ABCDEFGH
DATE     98/04/09
14:22:40 PM
CALIBRATED(EXT.)
CAL.WEIGHT
      +200.0000 g
SIGNATURE
-----
  
```

### Data format

```

inf 2
      A & D<TERM>
MODEL    GR-200<TERM>
S/N      12345678<TERM>
ID        ABCDEFGH<TERM>
DATE<TERM>
<TERM>
TIME<TERM>
<TERM>
CALIBRATED(EXT.)<TERM>
CAL.WEIGHT<TERM>
      +200.0000 g<TERM>
SIGNATURE<TERM>
<TERM>
<TERM>
-----<TERM>
<TERM>
<TERM>
  
```

- ␣ Space mark, ASCII 20H.
- <TERM> Terminator mark, C<sub>R</sub> L<sub>F</sub> or C<sub>R</sub>.
- C<sub>R</sub> Carriage return mark, ASCII 0DH
- L<sub>F</sub> Line feed mark, ASCII 0AH

Example of GR-200

# Calibration Test Report using an external weight

## Key operation

Step 1 Press and hold the **CAL** key until displaying **[[[ CAL ]]]**. Release the key.

Step 2 The balance displays **[[[ 0 ]]]**.

- If you want to change the target weight value, proceed to step 3.
- If you use the stored target weight value in the balance, proceed to step 4.

Step 3 Press the **RANGE** key and adjust target weight using the following keys.

- RE-ZERO** key The key to set the value of the digit selected.
- RANGE** key The key to select the digit to change value.
- PRINT** key The key to store a new weight value and return to step 2.
- CAL** key The key to cancel this change and return to step 2.

Step 4 Press the **PRINT** key. The zero point is measured and this value is displayed.

Step 3 Place the calibration weight on the pan and press the **PRINT** key. The weight is measured and this value is displayed.

Step 4 Remove the weight after **[[[ End ]]]** is displayed.

Step 5 If the calibration test report is output, **[[[ P ]]]** is displayed and the GLP data is output.

Step 6 The balance returns to the weighing mode automatically.

### AD-8121 format

```

info 1
      A & D
MODEL   GR-200
S/N     12345678
ID      ABCDEFGH
DATE    98/04/09
14:30:24 PM
CAL.TEST(EXT.)
ACTUAL
      0.0000 g
      +200.0002 g
TARGET
      +200.0000 g
SIGNATURE
-----
  
```

### Data format

```

info 2
      A & D<TERM>
MODEL   GR-200<TERM>
S/N     12345678<TERM>
ID      ABCDEFGH<TERM>
DATE<TERM>
<TERM>
TIME<TERM>
<TERM>
CAL.TEST(EXT.)<TERM>
ACTUAL<TERM>
      0.0000 g<TERM>
      +200.0002 g<TERM>
TARGET<TERM>
      +200.0000 g<TERM>
SIGNATURE<TERM>
<TERM>
<TERM>
-----<TERM>
<TERM>
<TERM>
  
```

- ␣ Space mark, ASCII 20H.
- <TERM> Terminator mark, C<sub>R</sub> L<sub>F</sub> or C<sub>R</sub>.
- C<sub>R</sub> Carrige return mark, ASCII 0DH
- L<sub>F</sub> Line feed mark, ASCII 0AH

Example of GR-200

# Title Block and End Block

## Use

When a weight value is recorded as the GLP data, the GLP report can put the weighing value between "Title block" and "End block".

## Caution

If data memory function is used, The "Title block" and "End block" can not be output. Use MODE 3 of the AD-8121.

## Key operation

Step 1 Press and hold the **PRINT** key to display **Start** and release the key. The "Title block" is output.

Step 2 The weighing data is output.

Step 3 Press and hold the **PRINT** key to display **Rec End** and release the key. The "End block" is output.

The "Title block" and "End block" are output alternately by pressing the **PRINT** key.

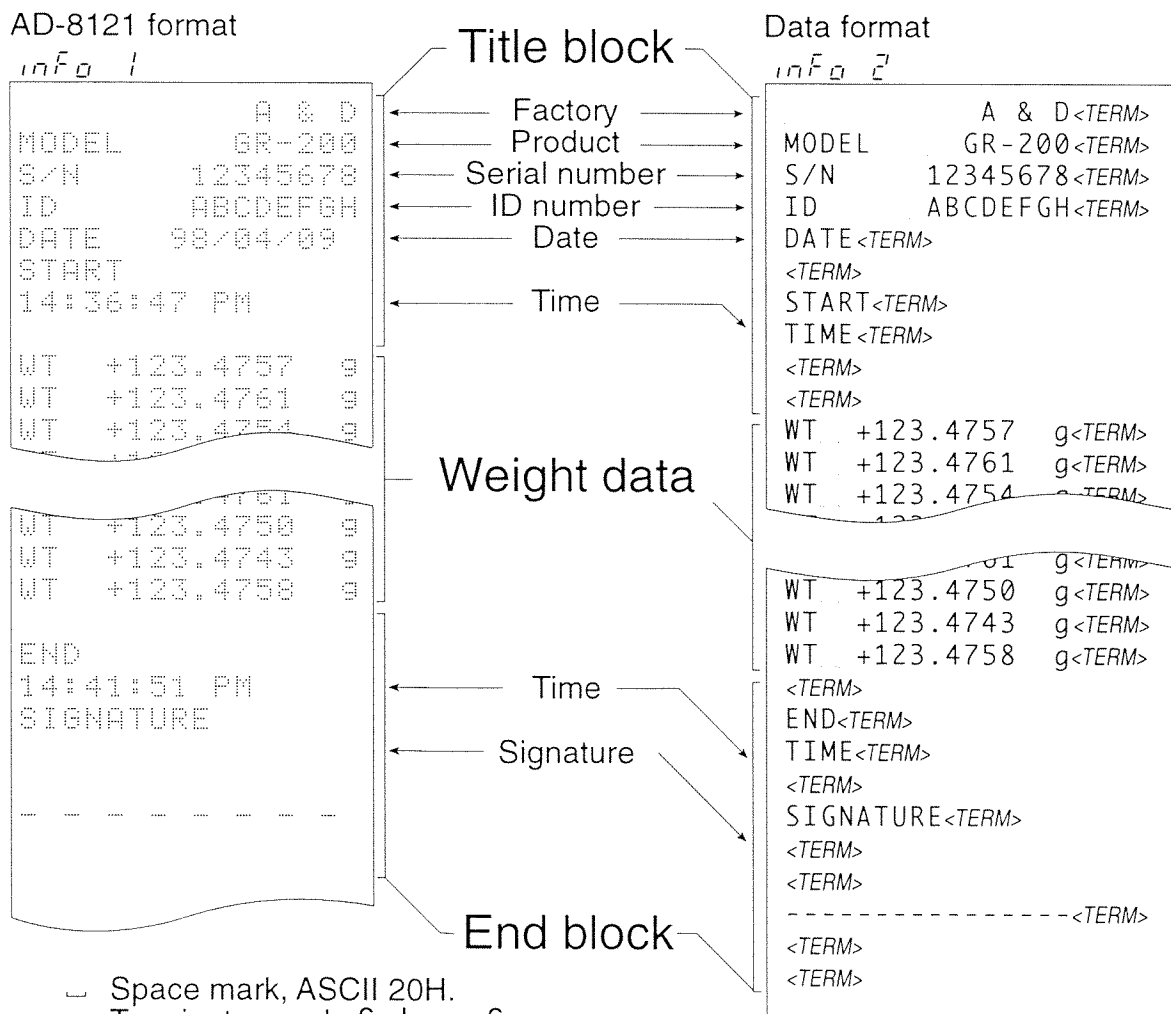

- └ Space mark, ASCII 20H.
- <TERM> Terminator mark, C<sub>R</sub> L<sub>F</sub> or C<sub>R</sub>.
- C<sub>R</sub> Carriage return mark, ASCII 0DH
- L<sub>F</sub> Line feed mark, ASCII 0AH



# 11. Data Memory Function



## Use and The Method of Storing Data

- ❑ The data memory function can store 200 sets of weighing data. If the power switch is turned off, AC power is interrupted or the AC adapter is removed, the data is maintained in non-volatile memory.
- ❑ It is not necessary that the printer or computer be continually connected to the balance, because the balance stores the weight data in memory.
- ❑ There are four types of operating modes to store the data.
 

Key Mode	When you press the <span style="border: 1px solid black; padding: 2px;">PRINT</span> key and the display value is stable, the balance stores the weighing data.
Auto-Print Mode A	When the display value is stable and meets the conditions of "Auto-print polarity", "Auto-print band" and standard value (of zero point), the balance stores the weighing data.
Auto-Print Mode B	When the display value is stable and meets the conditions of "Auto-print polarity", "Auto-print band" and standard value (of last stable value), the balance stores the weighing data.
Interval Memory Mode	Weighing data is periodically stored in the balance. This mode can be started or stoped using the <span style="border: 1px solid black; padding: 2px;">PRINT</span> key .
- ❑ The data number can be appended just before the weighing data. (This is the serial number of the data in memory.)

### Symbols

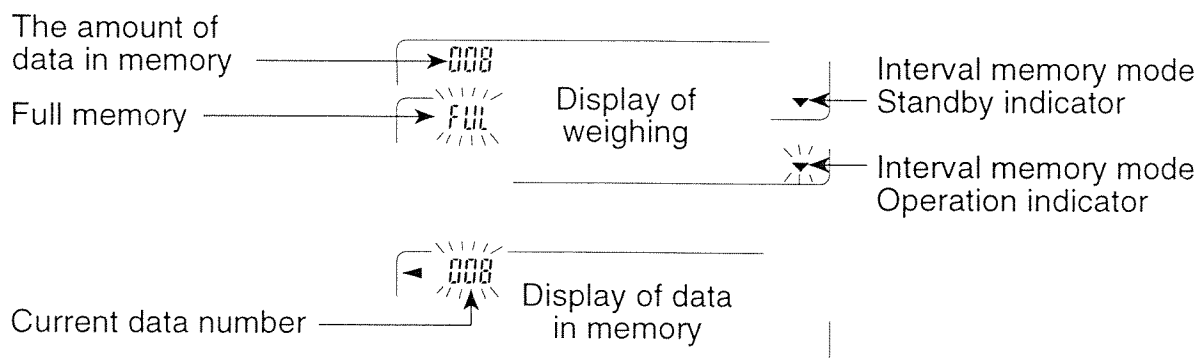

## Caution

- ❑ When weighing data is being placed in memory, the data can be not output to the RS-232C interface.
- ❑ The "FULL" means full memory. More data can be not stored until deletion of the stored data.
- ❑ Automatic self calibration can not be used while the interval memory mode is working.
- ❑ The following commands can not be used during data storage.
  - Q     Query command for weighing data.
  - S     Request command for stable weighing data.
  - SI    Query command for weighing data.
  - SIR   Request command for continuous weighing data.



## Preparation of the Function Table

Mode	Item	Data output mode	Auto-print polarity	Data memory function	Interval time
Key mode		Prt 0	—	dAtA 1	—
Auto-Print Mode A		Prt 1	AP-P 0~2	dAtA 1	
Auto-Print Mode B		Prt 2	AP-b 0~2	dAtA 1	
Interval Memory Mode		Prt 3	—	dAtA 1	

Not used data number	d-no 0
Use data number	d-no 1

### Note

The data memory function does not work with dAtA 0.



## Output of Data from Memory

### Displaying and Transmitting the Data

Step 1 Press and hold the **PRINT** key until displaying **rE[ALL]** and release the key.

Step 2 Press the **PRINT** key to enter the mode. Use the following keys.

**RE-ZERO** key

The key to proceed to the next data.

**MODE** key

The key to go back to the previous data.

**PRINT** key

The key to transmit the current data to the RS-232C interface.

**RANGE** key is pressed and held then press the **CAL** key

The keys to delete the current data

**CAL** key

The key to exit this mode.

Step 3 Press the **CAL** key. The balance returns to weighing mode.



## Transmitting All data at One Time

- Step 1 Setup the RS-232C interface using "5, F" of the function table.
- Step 2 Press and hold the **PRINT** key until displaying **r E E A L L** and release the key.
- Step 3 Press the **RANGE** key to display **out**.
- Step 4 Press the **PRINT** key to enter this mode.
- Step 5 Press the **RE-ZERO** key. Then the balance displays **out 00**.
- Step 6 Press the **PRINT** key to transmit all data to RS-232C interface.
- Step 7 The balance displays **[ L E A r ]** after the finish.
- Step 8 Press the **CAL** key to return to weighing mode.

## The Data Number

When the "Data number output (d' - n d)" is set to "1" and the data that is stored in the balance memory is to be output, the "Data number" can be appended just before each data. This format consists of six characters (excluding the terminator).

N	o	.	0	0	1	C <sub>R</sub>	L <sub>F</sub>									
S	T	,	+	0	0	0	.	1	2	7	8	□	□	g	C <sub>R</sub>	L <sub>F</sub>

## Deleting All Data at One Time

- Step 1 Press and hold the **PRINT** key until displaying **r E E A L L** and release the key.
- Step 2 Press the **RANGE** key several times to display **[ L E A r ]**.
- Step 3 Press the **PRINT** key to enter this mode.
- Step 5 Press the **RE-ZERO** key. Then the balance displays **[ L r 00 ]**.
- Step 6 Press the **PRINT** key to delete all data.
- Step 7 The balance displays **r E E A L L** after the finish.
- Step 8 Press the **CAL** key to return to weighing mode.



## 12. Underhook

The underhook can be used for weighing large items, magnetic material or density measurement.

The built-in underhook is behind the plastic cap on the under-side of the balance.

### Caution

- When not using the underhook, attach the plastic cap to prevent dust from getting into the balance.
- The underhook can only be used to support items within the weight range of the balance. Do not overload it.
- Operate the underhook gently.

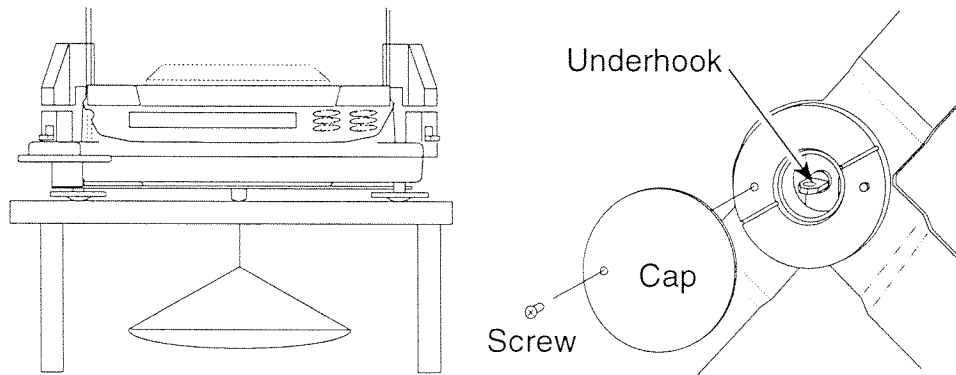



## 13. Specific gravity (density) measurement

GR series balances are equipped with the specific gravity measuring mode. It calculates the density of a solid according to the weight of the sample in air and weight in liquid.

- The specific gravity measuring mode is not ready for use upon receiving the balance. To use the mode, change the function table and activate the specific gravity measuring mode.
- Two ways to set the density of a liquid are available: by entering the water temperature and by entering the density directly.

### Formula to obtain the density

The density can be obtained by the following formula.

$$\rho = \frac{A}{A-B} \times \rho_0$$

$\rho$  : Density of sample

A : Weight of sample in air

B : Weight of sample in liquid

$\rho_0$  : Density of liquid

### Changing the function table

#### (1) Setting the specific gravity measuring mode

The specific gravity measuring mode is available as one of the units. To use the mode, select it in the function table. For how to select the specific gravity measuring mode, see "Selecting a unit and arranging the sequence of display" in Chapter 4. (Select Unit d )

#### (2) Selecting the way to set the density of a liquid

Select the liquid density method from the function table below. The function table is available only when the specific gravity measuring mode is selected. For how to select, see Chapter 9 "Function Table".

Class	Item	Parameter	Summaries
d5 Fnc Specific gravity measuring mode	Ld in Liquid density	• <span style="border: 1px solid black; padding: 2px;">d</span>	Enter the water temperature.
		/	Enter the density directly.

• : factory setting

### Setting the density of a liquid

1. Press the MODE key as necessary to select the specific gravity measuring mode. When the processing indicator (upper left ◀ ) flashes with the unit "g" displayed, it indicates that the specific gravity measuring mode is selected.

2. In the specific gravity measuring mode, press and hold the **MODE** key to enter the mode to set the liquid density.

### Note

- In the normal weighing mode, the same procedure will activate the automatic response adjustment. This function is not available in the specific gravity measuring mode.

### Entering the water temperature ( $\rho_{d \text{ in } T}$ )

In the specific gravity measuring mode, press and hold the **MODE** key until the water temperature currently set (unit : °C, factory setting : 25°C) is displayed. Use the following keys to change the value.

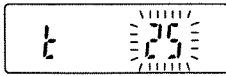

- RE-ZERO** key Increases the temperature by one degree. (0-99°C)
- MODE** key Decreases the temperature by one degree. (0-99°C)
- PRINT** key saves the change, displays "  $\rho_{d \text{ in } T}$  " and returns to the specific gravity measuring mode.
- CAL** key Returns to the specific gravity measuring mode without saving the change.

The relation between the water temperature and density.

Temperature ( C )	+0	+1	+2	+3	+4	+5	+6	+7	+8	+9
0	0.99984	0.99990	0.99994	0.99996	0.99997	0.99996	0.99994	0.99990	0.99985	0.99978
10	0.99970	0.99961	0.99949	0.99938	0.99924	0.99910	0.99894	0.99877	0.99860	0.99841
20	0.99820	0.99799	0.99777	0.99754	0.99730	0.99704	0.99678	0.99651	0.99623	0.99594
30	0.99565	0.99534	0.99503	0.99470	0.99437	0.99403	0.99368	0.99333	0.99297	0.99259
40	0.99222	0.99183	0.99144	0.99104	0.99063	0.99021	0.98979	0.98936	0.98893	0.98849
50	0.98804	0.98758	0.98712	0.98665	0.98618	0.98570	0.98521	0.98471	0.98422	0.98371
60	0.98320	0.98268	0.98216	0.98163	0.98110	0.98055	0.98001	0.97946	0.97890	0.97834
70	0.97777	0.97720	0.97662	0.97603	0.97544	0.97485	0.97425	0.97364	0.97303	0.97242
80	0.97180	0.97117	0.97054	0.96991	0.96927	0.96862	0.96797	0.96731	0.96665	0.96600
90	0.96532	0.96465	0.96397	0.96328	0.96259	0.96190	0.96120	0.96050	0.95979	0.95906

## Entering the density directly ( $\rho$ in $g/cm^3$ )

In the specific gravity measuring mode, press and hold the **MODE** key until the density currently set ( unit :  $g/cm^3$ , factory setting :  $1.0000g/cm^3$  ) is displayed. Use the following keys to change the value.



- |                    |                                                                                           |
|--------------------|-------------------------------------------------------------------------------------------|
| <b>RE-ZERO</b> key | Changes the numerical value of the digit selected.                                        |
| <b>RANGE</b> key   | Selects the digit to change the value.                                                    |
| <b>PRINT</b> key   | Saves the change, displays " $\rho$ " and returns to the specific gravity measuring mode. |
| <b>CAL</b> key     | Returns to the specific gravity measuring mode without saving the change.                 |

### Note

- The range to set the density is  $0.0000-1.9999 g/cm^3$ . (Displayed up to four decimal places)

### Measuring the density

In the density measurement, the balance displays the weight of the sample in air, the weight in liquid and then the density.

- Measuring the weight of the sample in air.

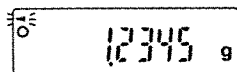

The processing indicator flashes with the unit " g " displayed.

- Measuring the weight of the sample in liquid.

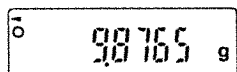

The processing indicator illuminates with the unit " g " displayed.

- Displaying the density.

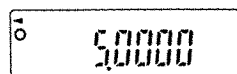

The processing indicator illuminates with no unit displayed.

To switch between the above three, use the **RANGE** key.

## Measuring procedure

- Step 1 Confirm that the balance is in the mode to measure the weight of the sample in air. (" g " displayed and processing indicator flashing)
- Step 2 Confirm that the balance indicates zero. If it does not indicate zero, press the **RE-ZERO** key to reset the displayed value to zero.
- Step 3 Place the sample on the upper pan ( in air ). When the value displayed on the balance becomes stable, press the **RANGE** key to confirm the value ( the weight of sample in air ). The balance enters the mode to measure the weight of sample in liquid ( " g " displayed and processing indicator illuminating).

**Note :** If a negative value or E (error) is displayed, the **RANGE** key is disabled.

- Step 4 Place the sample on the lower pan (in liquid). When the value displayed on the balance becomes stable, press the **RANGE** key to confirm the value (the weight of sample in liquid). The balance enters the mode to display the density ( " g " not illuminated).

**Note :** If E (error) is displayed, the **RANGE** key is disabled.

- Step 5 To output or save the density, press the **PRINT** key. The unit for outputting the density is " DS ". To measure the density of another sample, press the **RANGE** key to return to the mode to measure the weight in air and repeat the procedure described above.

**Note :** If the liquid temperature or the type of liquid is changed during measurement, reset the value of the liquid density as necessary. For details, see " Setting the density of a liquid ".

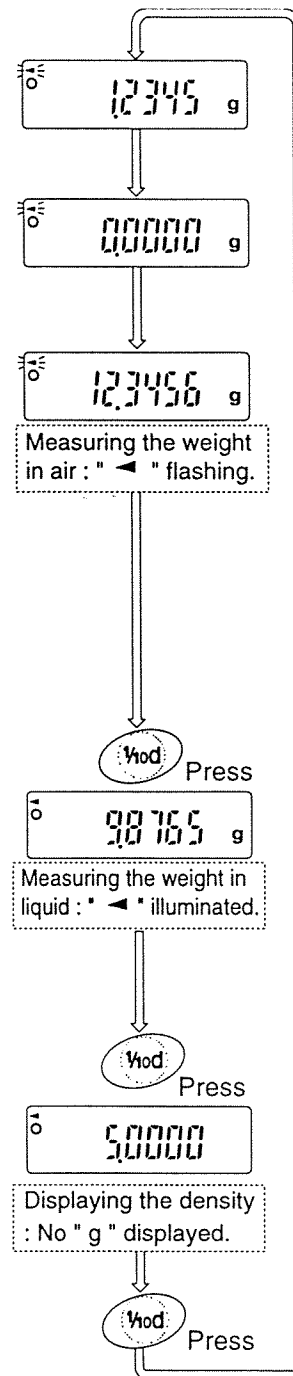



# 14. RS-232C Specifications

Transmission system : EIA RS-232C  
 Transmission form : Asynchronous, bi-directional, half duplex  
 Data format : Baud rate : 600, 1200, 2400, 4800, 9600 bps  
                   Data : 7 or 8 bits  
                   Parity : Even, Odd (7 bits)  
                                           None (8 bits)  
                   Stop bit : 1 bit  
                   Code : ASCII

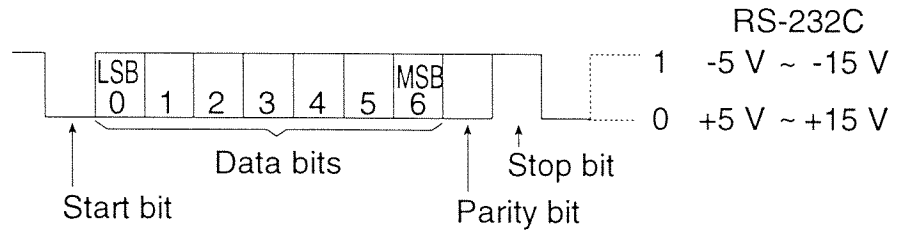

## Pin connections

Pin No.	Signal name	Direction	Description
1	FG	-	Frame ground
2	RXD	Input	Receive data
3	TXD	Output	Transmit data
4	RTS	Input	Ready to send
5	CTS	Output	Clear to send
6	DSR	Output	Data set ready
7	GND	-	Signal ground
8 - 25	N.C.	-	-

## Circuits

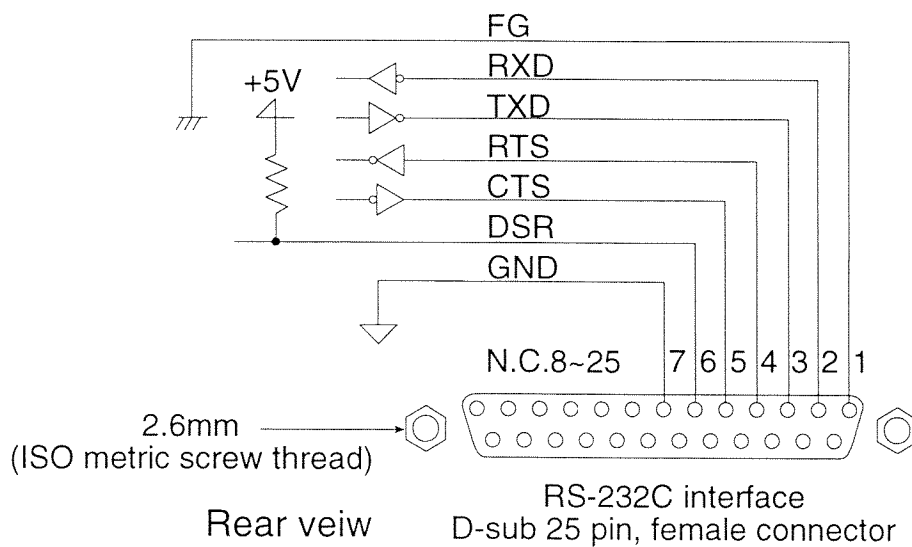



## 15. Connection to Equipment



### Connection to the AD-8121 Printer

- Set the following parameters to use the AD-8121 printer.

Function items	Summaries
<i>dout Prt 0,1,2,3</i>	Selection of a print mode.
<i>dout AP-P 0,1,2</i>	Selection of the polarity for the auto-print mode.
<i>dout AP-b 0,1,2</i>	Selection of the auto-print band.
<i>dout PUSE 0,1</i>	Selection of pause.
<i>SIF bPS 2</i>	"2400bps".
<i>SIF bPr 0</i>	"7 bits, Even parity check".
<i>SIF CrLF 0</i>	"CR, LF".
<i>SIF Cts 0</i>	"Not using CTS and RTS".

The case of using "MODE 1" or "MODE 2" of the AD-8121 printer.

<i>SIF tYPE 0</i>	A&D standard format
-------------------	---------------------

The case of using "MODE 3" of the AD-8121 printer.

<i>SIF tYPE 0</i>	DP format
-------------------	-----------

The case of transmitting data continuously.

The case of transmitting all memory data at one time.

<i>dout PUSE 1</i>	Use of pause
--------------------	--------------

### Memo

In the case of *DATA 0*, the weighing data can be printed.

In the case of *DATA 1*, the memory data can be printed.

Refer to "10. ID number and GLP Report" for a print sample.

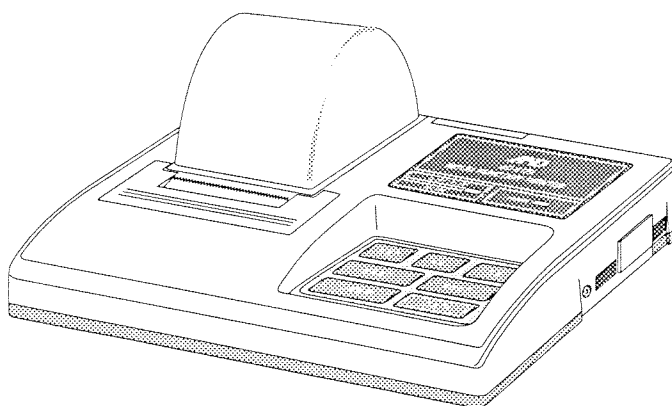





## Connection to a Computer

- The RS-232C is of the DCE type (Data Communications Equipment) and can use standard DCE cables.
- When connecting to other equipment, check the manual for that equipment for proper settings and connections.
- Keep the RTS line set "HI", when RTS is used.

### Program Example

This example sets the display to zero, waits for placing a weight, requires stable weighing data and displays it. Set the balance functions as follows:

<i>dout Prt 0</i>	Data output mode : Key mode
<i>dout PUSE 0</i>	Data pause : Not used
<i>dout DATA 0</i>	Data memory function : Not used
<i>S iF bPS 2</i>	Baud rate : 2400pbs
<i>S iF bLPr 0</i>	Data length and parity : 7 bit EVEN
<i>S iF CrLF 0</i>	Terminator : CR LF
<i>S iF tYPE 0</i>	Data format : A&D standard
<i>S iF ErEd 1</i>	Error code and <AK> : Output, <AK> (ASCII code 06h)

**Caution** Some computers can not run this program as it is, the program may require modification. Refer to the manual for the computer.

```

10 OPEN "COM1:2400,E,1,CS8000" AS #1  Declaration of protocol.
20 PRINT #1, "R"+CHR$(13)+CHR$(10)  Request to zero the display.
30 LINE INPUT #1, AK$              To receive the verification code <AK> from
                                   the balance for the re-zero command.

40 IF AK$<>CHR$(6) THEN *MEMO      If not <AK>, display the error message.
50 LINE INPUT #1, AK$              Reception of verification code <AK> for end-
                                   ing the command.

60 IF AK$<>CHR$(6) THEN *MEMO      If not <AK>, display the error message.
100 FOR II=1 TO 1000: NEXT II      Wait time for placing weight.
200 PRINT #1, "S"+CHR$(13)+CHR$(10) Request for the stable weighing data.
210 INPUT #1, HD$, DT$            Reception of the header and data.
220 PRINT HD$, DT$                Display the header and data.
230 CLOSE #1                       Close communications
240 END                             End
300 *MEMO                           Label
310 PRINT "AN ERROR HAS OCCURRED"  Error message
320 CLOSE #1                         Close communications
330 END                             End

```



## 16. Commands



### Command list

Commands to request weighing data

<b>C</b>	Cancel command for the <b>SIR</b> command.
<b>Q</b>	Query command for weighing data.
<b>S</b>	Request command for stable weighing data.
<b>SI</b>	Query command for weighing data.
<b>SIR</b>	Request command for continuous weighing data.

Commands to control the balance

<b>CAL</b>	Calibration command.
<b>MCL</b>	Command to delete all stored data.
<b>MD:nnn</b>	Command to delete data of data number nnn.
<b>OFF</b>	Display OFF command.
<b>ON</b>	Display ON command.
<b>P</b>	Same as the <b>ON:OFF</b> key, Display ON/OFF command.
<b>PRT</b>	Same as the <b>PRINT</b> key.
<b>R</b>	Same as the <b>RE-ZERO</b> key, RE-ZERO command.
<b>RNG</b>	Same as the <b>RANGE</b> key, Range command.
<b>TST</b>	Calibration test command.
<b>U</b>	Same as the <b>MODE</b> key, Unit command.

Commands to request stored data

<b>?MA</b>	Output command to transmit all memory data.
<b>?MQnnn</b>	Request command to transmit data of data number nnn.
<b>?MX</b>	Query command for last data number.

nnn : numerical value of three figures



## Commands to Request Weighing Data

C

### Cancel command for the SIR command

The balance will stop sending data in stream mode.

Command 

C	C <sub>R</sub>	L <sub>F</sub>
---	----------------	----------------

Reply (Output is stopped.)

Q

### Query command for weighing data

The balance will respond with the weighing data immediately.

Command 

Q	C <sub>R</sub>	L <sub>F</sub>
---	----------------	----------------

Reply 

S	T	,	+	0	0	1	.	2	7	8	3	_	_	g	C <sub>R</sub>	L <sub>F</sub>
---	---	---	---	---	---	---	---	---	---	---	---	---	---	---	----------------	----------------

S

### Request command for stable weighing data

The balance display will blink when the data is transmitted.

Command 

S	C <sub>R</sub>	L <sub>F</sub>
---	----------------	----------------

Reply 

S	T	,	+	0	0	2	.	2	8	3	5	_	_	g	C <sub>R</sub>	L <sub>F</sub>
---	---	---	---	---	---	---	---	---	---	---	---	---	---	---	----------------	----------------

S I

### Query command for weighing data

The balance will respond with the weighing data immediately.

Command 

S	I	C <sub>R</sub>	L <sub>F</sub>
---	---	----------------	----------------

Reply 

S	T	,	+	0	0	2	.	2	8	3	5	_	_	g	C <sub>R</sub>	L <sub>F</sub>
---	---	---	---	---	---	---	---	---	---	---	---	---	---	---	----------------	----------------

S I R

### Request command for continuous weighing data

The balance sends the data in stream mode.

Command 

S	I	R	C <sub>R</sub>	L <sub>F</sub>
---	---	---	----------------	----------------

Reply 

U	S	,	+	0	0	2	.	7	8	3	5	_	_	g	C <sub>R</sub>	L <sub>F</sub>
---	---	---	---	---	---	---	---	---	---	---	---	---	---	---	----------------	----------------

⋮

S	T	,	+	0	0	2	.	7	8	3	5	_	_	g	C <sub>R</sub>	L <sub>F</sub>
---	---	---	---	---	---	---	---	---	---	---	---	---	---	---	----------------	----------------

S	T	,	+	0	0	2	.	7	8	3	5	_	_	g	C <sub>R</sub>	L <sub>F</sub>
---	---	---	---	---	---	---	---	---	---	---	---	---	---	---	----------------	----------------

## Caution

When the baud rate is set to 2400bps or less, the display update rate is faster than the output rate and the balance may not transmit the data completely (and transmits it intermittently).



## Commands to Control the Balance

**C A L**

### Calibration command

Balance performs calibration using the internal weight.

Command **C A L C<sub>R</sub> L<sub>F</sub>**

Reply (Balance is calibrated)

**M C L**

### Command to delete all stored data.

Command **M C L C<sub>R</sub> L<sub>F</sub>**

Reply (<AK> code is replied)

**M D : n n n**

### Command to delete data of data number nnn.

Command **M D : 0 2 5 C<sub>R</sub> L<sub>F</sub>**

Reply (<AK> code is replied)

**O F F**

### Display OFF command

If the balance is ON, it will turn OFF.

If the balance is already off, nothing will happen.

Command **O F F C<sub>R</sub> L<sub>F</sub>**

Reply (Balance turns off)

**O N**

### Display ON command

If the balance is OFF, it will turn ON.

Command **O N C<sub>R</sub> L<sub>F</sub>**

Reply (Balance turns on)

**P**

Same as the **ON:OFF** key, Display **ON/OFF** command.

The balance turns on ( or turns off). The command works as the **ON:OFF** key.

Command **P C<sub>R</sub> L<sub>F</sub>**

Reply (Balance turns on or off alternately)

**P R T**

Same as the **PRINT** key, **Print** command.

The command works as the **PRINT** key.

Command **P R T C<sub>R</sub> L<sub>F</sub>**

Reply (A data is output)

**R**

Same as the **RE-ZERO** key, **RE-ZERO** command.

The balance will display zero. The command works as the **RE-ZERO** key.

Command **R C<sub>R</sub> L<sub>F</sub>**

Reply (Zero is displayed)

**R N G**

Same as the **RANGE** key, **Range** command.

The range can be changed. The command works as the **RANGE** key.

Command **R N G C<sub>R</sub> L<sub>F</sub>**

Reply (Sample weight is stored in the balance)

T S T

**Calibration test command**

The balance performs the calibration test using the internal weight.

Command T S T C<sub>R</sub> L<sub>F</sub>

Reply (Calibration test is performed)

U

Same as the MODE key, **Unit command**.

The unit can be changed. The command works as the MODE key.

Command U C<sub>R</sub> L<sub>F</sub>

Reply (Unit is changed)



## Commands to Request Memory Data

? M A

**Output command** to transmit all memory data.

Command ? M A C<sub>R</sub> L<sub>F</sub>

Reply (Case to output data number)

No. 001 C<sub>R</sub> L<sub>F</sub>

ST, +002. 2835 g C<sub>R</sub> L<sub>F</sub>

No. 002 C<sub>R</sub> L<sub>F</sub>

ST, +002. 2826 g C<sub>R</sub> L<sub>F</sub>

No. 003 C<sub>R</sub> L<sub>F</sub>

ST, +002. 2837 g C<sub>R</sub> L<sub>F</sub>

⋮

? M Q n n n

**Request command** to transmit data of data number nnn.

Command ? M Q 0 2 5 C<sub>R</sub> L<sub>F</sub>

Reply (Case not to output data number)

No. 025 C<sub>R</sub> L<sub>F</sub>

ST, +002. 2414 g C<sub>R</sub> L<sub>F</sub>

? M X

**Query command** for last data number.

Command ? M X C<sub>R</sub> L<sub>F</sub>

Reply No. 135 C<sub>R</sub> L<sub>F</sub>



## Acknowledge Code and Error Codes

This is an explanation of  $\overline{E_r} \overline{[d]}$  of the function list  
<AK> (06h) ----Acknowledge in ASCII code.

### In the Case of $\overline{E_r} \overline{[d]}$ $\overline{[ ]}$

- The balance does not output <AK> code or the error code.

### In the Case of $\overline{E_r} \overline{[d]}$ $|$

- When the balance received a command requesting data and can not process it, the balance transmits an error code ( EC, Exx).  
When the balance is able to process a command requesting data, the balance outputs the data.

- When the balance receives a command to control the balance and can not process it, the balance transmits an error code ( EC, Exx).  
When the balance receives a command to control the balance and can process it, the balance transmits <AK> (06h) code.

- There are some commands that transmit plural <AK> (06h) code from the balance. See "Command Examples"

**CAL** command (Calibration command)

**ON** command (ON command)

**P** command (ON:OFF command)

**R** command (RE-ZERO command)

**TST** command (Calibration test)

- When a communication error has occurred due to external noise, or a parity error has occurred due to transmission error, the balance transmits an error code. In this case, send the command once more.



## Control using CTS and RTS

This is an explanation of  $\overline{[LS]}$  of the function list.

### In the Case of $\overline{[LS]}$ $\overline{[ ]}$

- Regardless of whether the balance can receive a command or not, the balance keeps the CTS line to HI. The balance outputs data regardless of condition of the RTS line.

### In the Case of $\overline{[LS]}$ $|$

- The CTS line is kept HI normally. When the balance can not receive the next command (ex. processing last command), the balance sets CTS line to LO. The balance confirms the level of the RTS line when data can be output. If the RTS level is HI, the balance outputs data. If the RTS level is LO, data is not output (It cancels data output).



# Command Examples

This example is set to [E5 / ] so as to output the <AK> code.  
 There is a delay time required between receiving <AK> and transmitting the next command. When the command is transmitted to the balance, include a time delay as follows :

```

1...
Example of a BASIC program 120 LINE INPUT #1, AK$
(delay statement)         130 FOR LL = 1 TO 1000 : NEXT LL
                           140 PRINT #1, "Q" + CHR$(13)
1...

```

<AK> is Acknowledge in ASCII code 06h. "LL" is the delay variable.

## ON Command (To turn on the display)

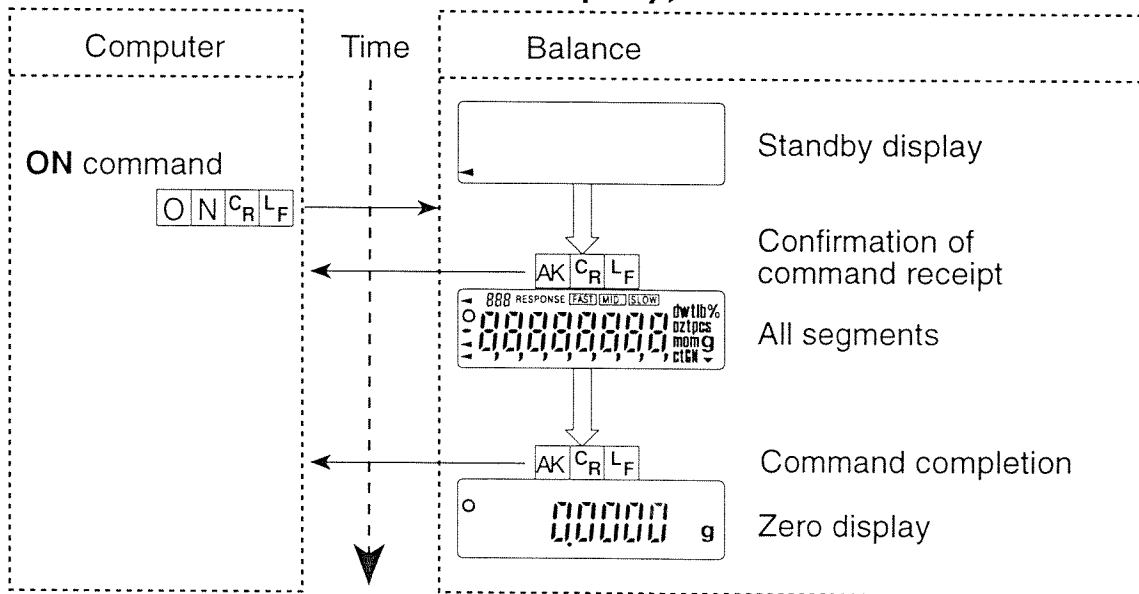

## R Command (To zero the display)

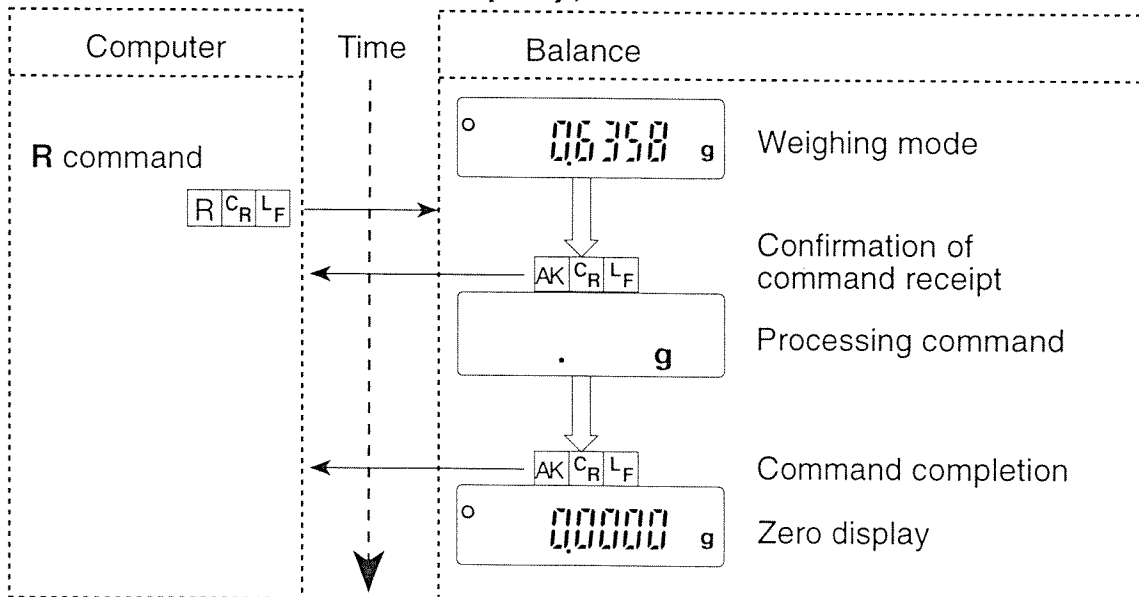

# CAL Command (To calibrate the balance)

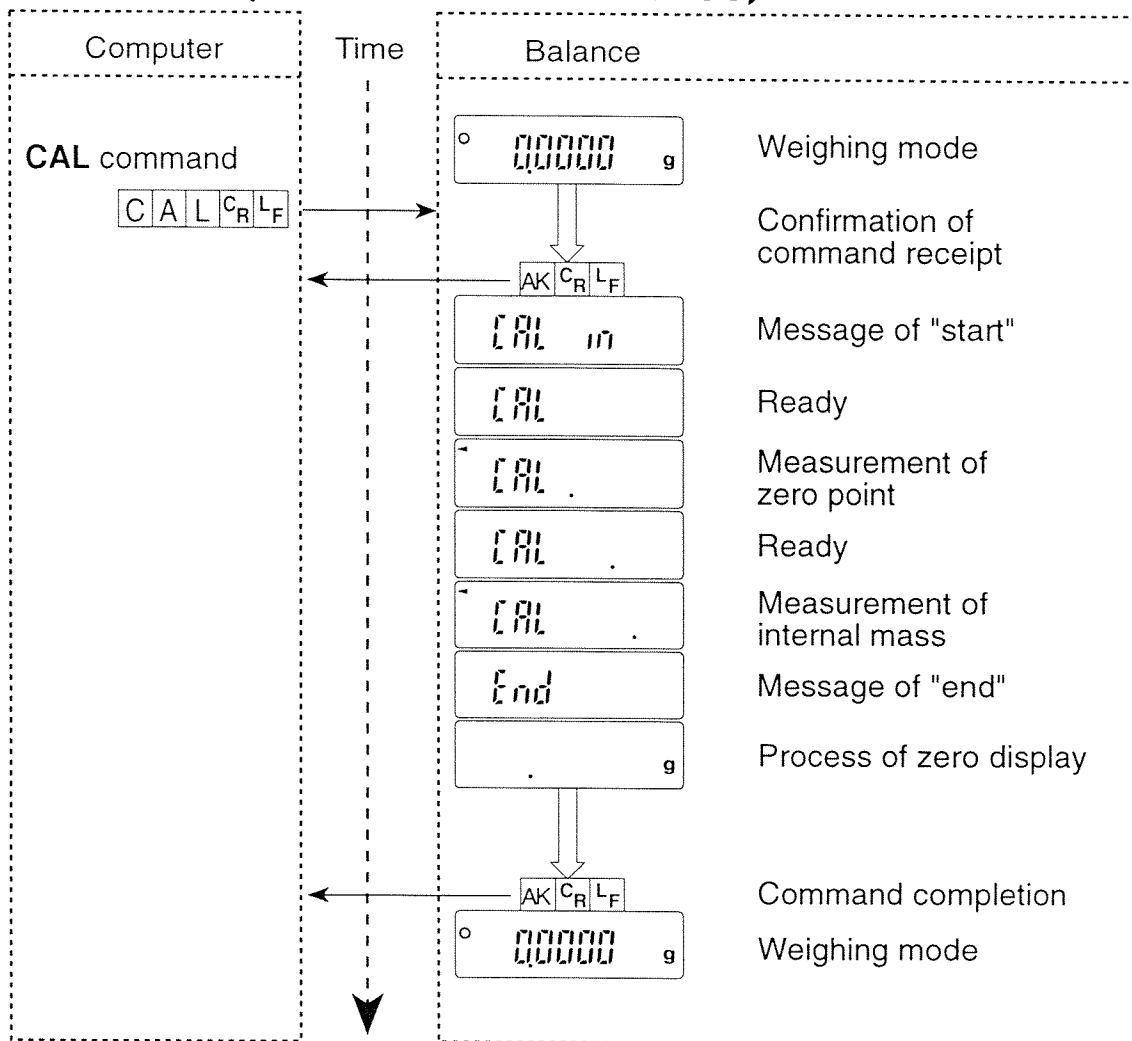



## Error Code and Command Cancellation

Example : When the **R** command is received, but the balance can not process it and an error code is output. This example is set to  $E_r [d] 1$ .

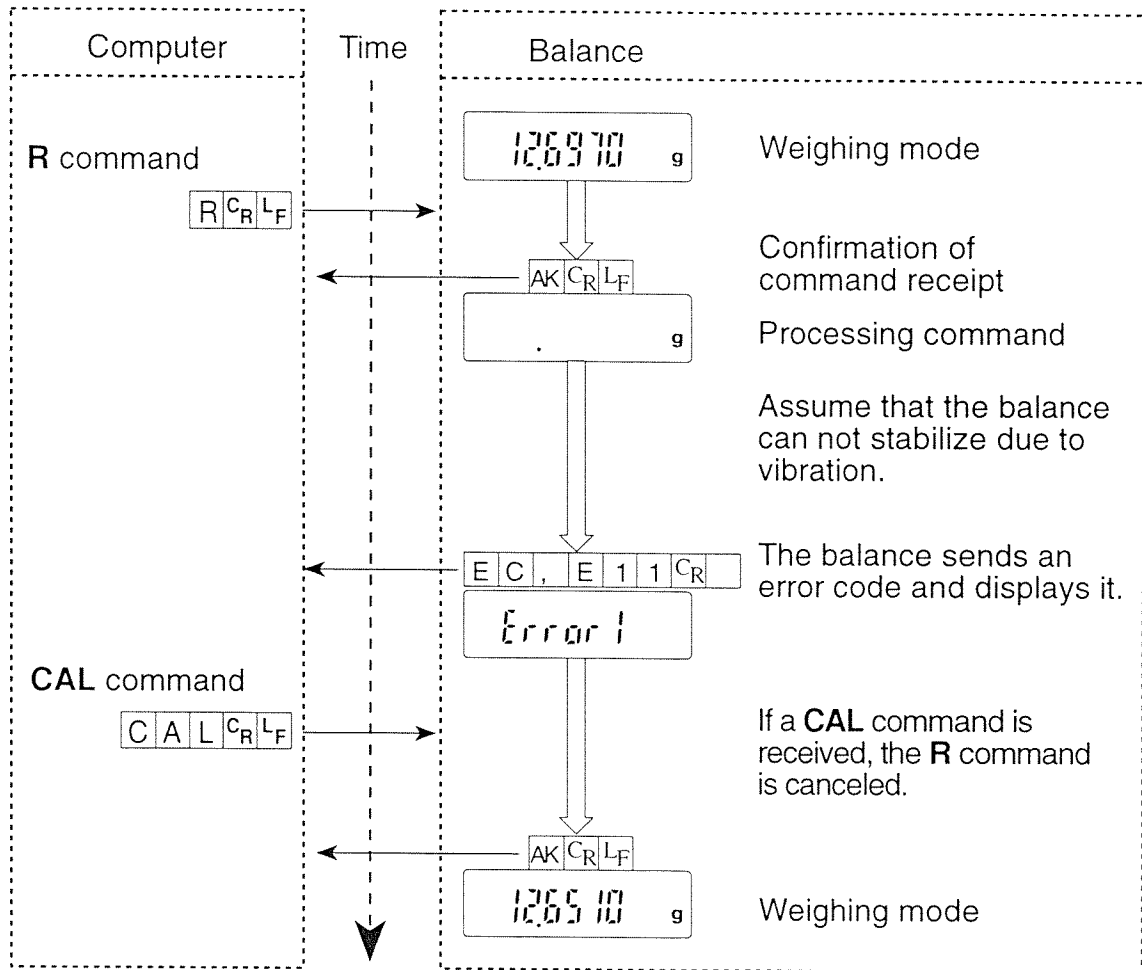



## 17. Maintenance



- ❑ Do not disassemble the balance. Contact your local A&D dealer if your balance needs service or repair.
- ❑ Please use the original shipping box for transportation.
- ❑ Do not use organic solvents to clean the balance. Use a warm lint free cloth that is damp, along with a detergent for cleaning.
- ❑ The "Floor Plate of the Weighing Chamber" can be removed and cleaned.
- ❑ Consider section "2. Caution" when operating the balance.

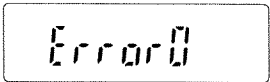
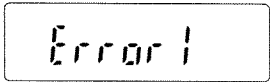
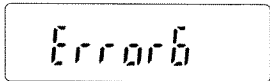
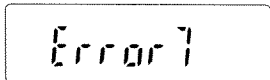
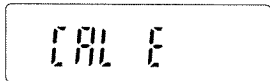
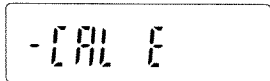
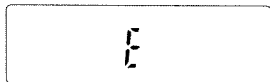

## Error Codes

Display	Error code	Description of the error
	EC, E00	<b>Communications error</b> A protocol error occurred in communications. <i>Confirm the format, baud rate and parity.</i>
	EC, E01	<b>Undefined command error</b> An undefined command was received. <i>Confirm command.</i>
	EC, E02	<b>Not ready</b> A received command can not be processed. <i>Adjust the delay time to transmit the command.</i> ex. The balance received a <b>Q</b> command, but not in the weighing mode. ex. The balance received a <b>Q</b> command while processing a RE-ZERO command.
	EC, E03	<b>Time over error</b> If t-Up 1 of the function list is set, the balance did not receive the next character of a command within the time limit of one second. <i>Confirm communication.</i>
	EC, E04	<b>Excess characters error</b> The balance received excessive characters in a command. <i>Confirm command.</i>

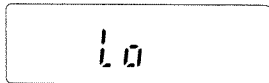
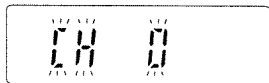
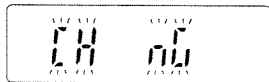
Display	Error code	Description of the error
	EC, E06	<b>Format error</b> A command includes incorrect data. <i>Confirm command.</i> ex. Data is numerically incorrect.
	EC, E07	<b>Range error for a parameter</b> The received data exceeds the range that the balance can accept. <i>Confirm parameter range of command.</i>
		<b>Internal condition information</b> There is no problem when displaying it a few seconds and returning to weighing mode. <i>Turn the balance off then on again, if the information is continuously displayed.</i>
	EC, E11	<b>Stability error</b> The balance can not stabilize due to an environmental problem. Press the <b>CAL</b> key to return to the weighing mode. <i>Prevent vibration, drafts, temperature changes, static electricity and magnetic fields.</i> <i>Read "Precautions for Installing the Balance" on page 5 and "Caution during Use" on page 6 and be well informed on how to use the balance.</i>
	EC, E16	<b>Internal weight error</b> This is a calibration error. <i>Confirm that there is nothing on the pan and retry the calibration or calibration test.</i>
	EC, E17	<b>Internal weight error</b> This is a calibration error. Retry the calibration or calibration test.
	EC, E20	<b>Calibration error</b> The calibration weight is too heavy. Press the <b>CAL</b> key to return to the weighing mode.
	EC, E21	<b>Calibration error</b> The calibration weight is too light. Press the <b>CAL</b> key to return to the weighing mode.
		<b>Over load</b> This is a warning that a weight beyond the balance capacity has been placed on the pan. Remove the weight from the pan.

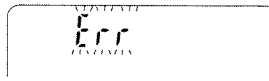
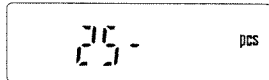
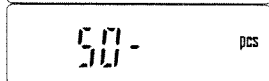
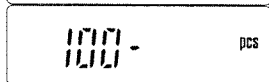
Display	Error code	Description of the error
		<b>Weighing pan Error</b> This is a warning that the weight value is too light. <i>Confirm that the weighing pan and the pan support are properly installed.</i>
		<b>Unit weight, 100% weight error</b> The unit weight of the sample is very light in the counting mode, or the 100% sample is too light in percent mode. The balance can not calculate it. <i>Increase the unit weight or 100% weight.</i>
		<b>ARA Zero error</b> The ARA (Automatic Response Adjustment) can not be performed, because there is something on the pan. <i>Remove all matter from the pan. Press the <span style="border: 1px solid black; padding: 0 2px;">CAL</span> key to return to the weighing mode.</i>
		<b>ARA Unstable error</b> The ARA (Automatic Response Adjustment) can not be performed because of unstable weighing value. <i>Correct the environment for the balance. Press the <span style="border: 1px solid black; padding: 0 2px;">CAL</span> key to return to the weighing mode.</i>
		<b>Full memory</b> The memory data has reached 200 items. <i>When data is deleted, new data can be stored.</i>
		<b>Memory data error</b> The memory data is lost. <i>Clear all memory data.</i>
		<b>Unit weight information</b> This is advice regarding the sample number that is needed to set the unit weight. When the unit weight is computed and the sample number is too few, the required number is displayed for counting accuracy. <i>Count and place the samples on the pan. Press the <span style="border: 1px solid black; padding: 0 2px;">PRINT</span> key to store the correct value.</i>
		
		

## Other errors

If you can not cancel the error yourself, request service from the store where you purchased the balance or option, or the A&D service group.



## Other Symbol



When this indicator blinks automatic self calibration is required. The indicator blinks when the balance detects a change in ambient temperature. If the balance is not used for several minutes with this indicator blinking, the balance Performs automatic self calibration. The environment may affect the time of blinking.



# 18. Specifications

	GR-120	GR-200	GR-300	GR-202
Weighing capacity	120 g	210 g	310 g	210 g/42 g
Min. weighing value (1 digit)	0.1 mg	0.1 mg	0.1 mg	0.1 mg/0.01 mg
Repeatability (Standard deviation)	0.1 mg	0.1 mg	0.2 mg	0.1 mg/0.02 mg
Linearity	±0.2 mg	±0.2 mg	±0.3 mg	±0.2 mg/±0.03 mg
Stabilization time (approx. )	3.5 sec	3.5 sec	3.5 sec	3.5 sec/8 sec
Sensitivity drift (10°C ~ 30°C) Ambient temperature	±2 ppm/°C (Automatic Self Calibration is not used) 5°C ~ 40°C (41°F ~ 104°F), RH < 85% (Do not allow condensation)			
Min. unit weight	0.1 mg			
Min. 100% weight	0.01 g			
Interface	RS-232C			
Calibration weight	Built-in weight			
External calibration weight	100 g	200 g	200 g	200 g
	50 g	100 g	300 g	100 g
Weighing pan	ø85 mm			
Weighing room	178(W) x 160(D) x 233(H) mm			
External dimension	249(W) x 330(D) x 327(H) mm			
Power consumption	Approx. 11VA (supplied to AC adapter )			
AC adapter , Power supply	Please confirm that the AC adapter is correct for your receptacle type and voltage [factory preset].			
Net weight	Approx. 6.0 kg			

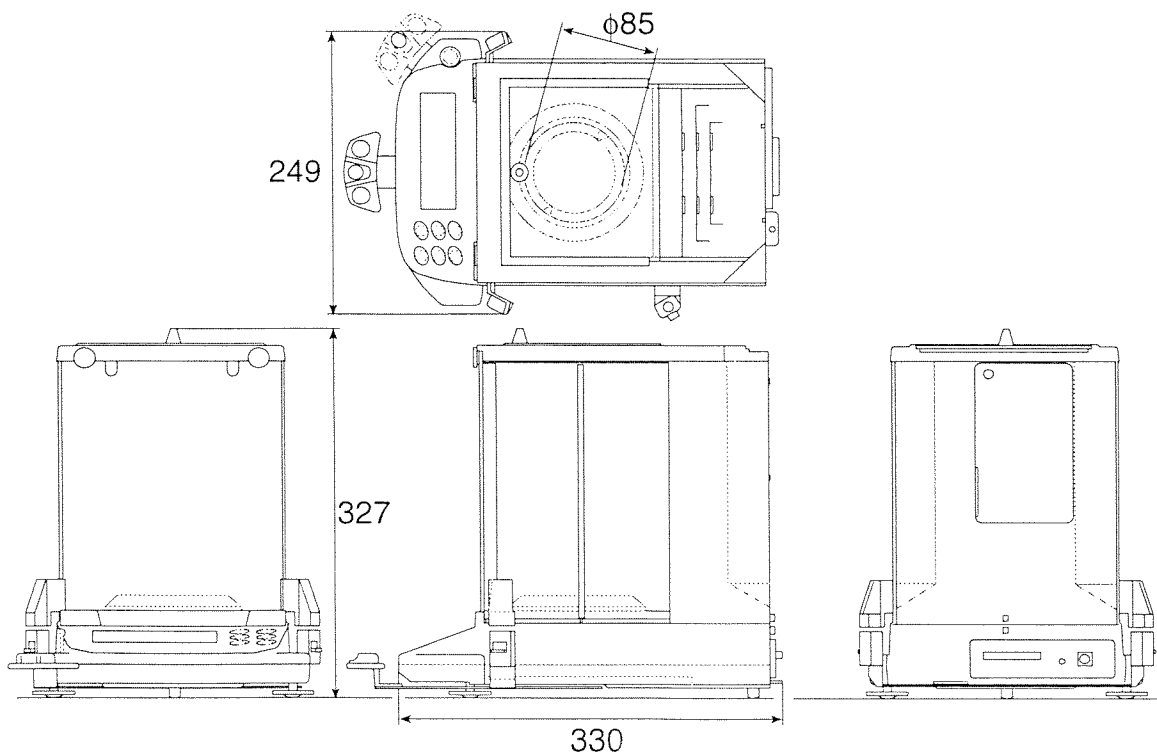



## Options

### AD-8121 Printer

- Compact thermal dot-matrix printer.
- Statistical function, calender and clock function, interval print function, graphic print function.
- 5x7 dots, 16 characters per line.
- Print paper (AX-PP143, 45mm(W)x50m(L), ø65mm)
- AC adapter or alkaline battery.

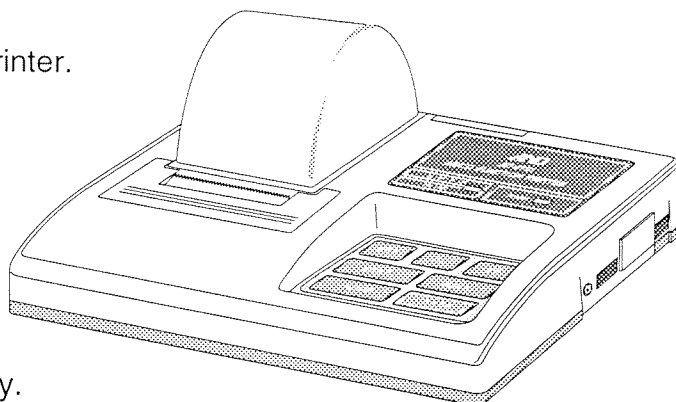

### AD-1653 Density Determination Kit

$$\frac{\text{Weigh in the air}}{\frac{\text{Underwater weight} - \text{Weigh in the air}}{\text{Water density}}} = \text{Density}$$

Example

$$\frac{10.0000 \text{ g}}{\frac{10.0000 \text{ g} - 9.5334 \text{ g}}{0.99970 \text{ g/cm}^3}} = 21.4 \text{ g/cm}^3$$

Water density	0°C	0.99984 g/cm <sup>3</sup>
	10°C	0.99970 g/cm <sup>3</sup>
	20°C	0.99820 g/cm <sup>3</sup>
	30°C	0.99565 g/cm <sup>3</sup>

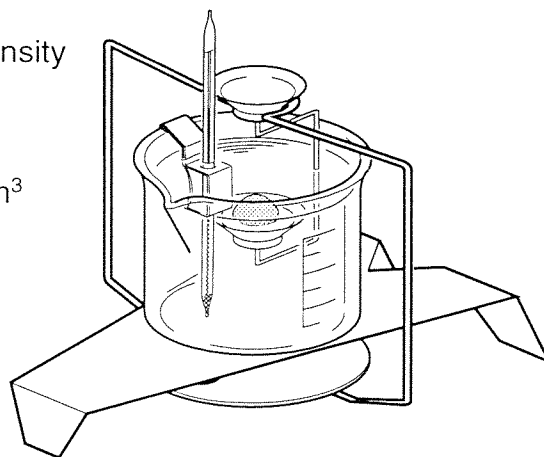

### External key Plug

This plug produces the same operations as pressing the **RE-ZERO** and **PRINT** keys. It enables remote control of the balance using an external key. This operation must connect the GND line to the PRINT or RE-ZERO line for at least 100 milli-seconds.

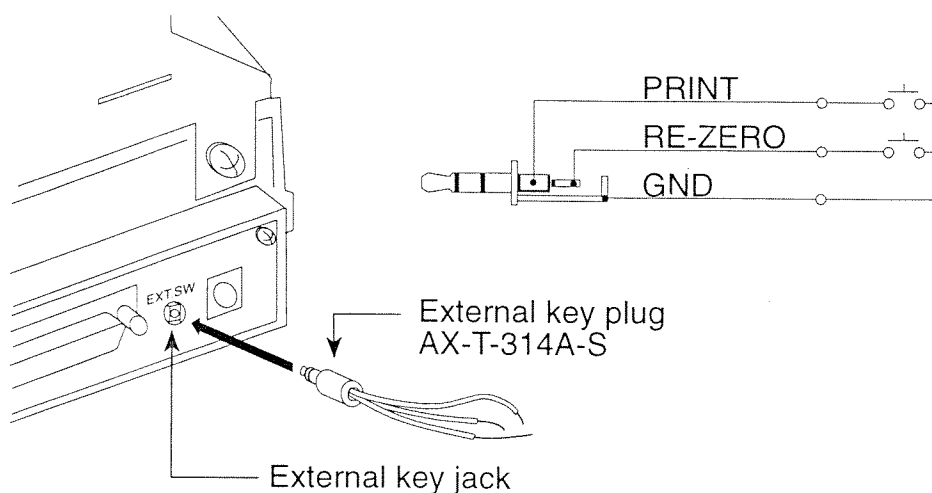



# 19. Index

## Symbols

%	15
	9, 46
	9, 46
	9, 19, 68
	16
	9
	14
	9, 18
	9
	9
	9
	9, 46
	67
	10
	10
	10
	10
	10
	10

## A

A&D standard format	36
A-01111	28
AC adapter	5, 7, 8, 9
ACAI	14
AD-8121	55, 70
AP-b	32, 35, 47
AP-P	32, 35, 47
Ar-d	32
At-F	32
Auto-Print Mode A	35, 46
Auto-Print Mode B	35, 46
Automatic Self Calibration	18, 19

## B

bRSFnc	32
Basic operation	3, 13
Baud rate	54
bPS	32
Breeze break ring	8
bLPr	32
Bubble spirit level	5, 8

## C

[AL 0]	22
[AL E]	66
-[AL E]	66
[AL in]	20
[AL out]	22
Calibration	10, 18
Calibration key	10
Calibration Report	40
Calibration test	18
Calibration Test Report	40
Calibration weight	18, 69
[C 0]	24
[C in]	21
[C out]	24
[H 0]	67
[H n0]	67
[LEAr]	48
[Lr]	29
[Lr 00]	48
Command	57
[and]	16, 32, 34
Counting mode	14
[rLF]	32
[S in]	26, 32
ct	11
[tS]	32, 61
CTS line	61

## D

d-no	32, 37, 47
D.P. format	36
dAtA	32, 47



Data format	36
Data number	46
Density	70
Display	8
Display Character Set	40
Door control lever	8
Door joint	8
<i>dout</i>	32
drafts	16
Dump print	36
Dust plate	8
dwt	11

## E

<i>E</i>	66
<i>-E</i>	67
EC, E00	65
EC, E01	65
EC, E02	65
EC, E03	65
EC, E04	65
EC, E06	66
EC, E07	66
EC, E11	66
EC, E16	66
EC, E17	66
EC Regulation	4
EMC	4
End block	40
<i>ErEd</i>	32, 61
<i>Err</i>	67
<i>Error 0</i>	66
<i>Error 1</i>	66
<i>Error 6</i>	66
<i>Error 7</i>	66
Error code	65
External key	70
External key jack	8
External weight	18

## F

FAST	16
FCC	4
Floor plate	8
<i>FULL</i>	46, 67
Function	3

## G

GLP	3, 10, 40
GN	11
Grain	11
gram mode	13
Grounding terminal	8

## I

<i>id</i>	32
ID number	40
<i>inf</i>	32
<i>int</i>	32, 47
Interval Memory Mode	36, 46

## K

Key	8, 10, 31
Key mode	35, 46
Key operation	10
KF format	37

## L

Leveling foot	8, 9
Linearity	69
<i>Ld</i>	67

## M

Magnetic material	6
Maintenance	3
mes	11
Messghal	11
Metric Carat	11
MID.	16
Mode key	10
mom	11
momme	11
MT format	37

## O

OL	36
ON/OFF key	10
Ounce	11

out	48
out Go	48
oz	11
ozt	11

## P

P-on	32, 34
Parity	54
Pennyweight	11
Percent mode	15
Pret	32, 34
Power consumption	69
Print key	10
Printer	55, 70
Pret	32, 35, 36, 47
PS	28, 29
PULSE	32

## Q

QT	36
----	----

## R

Range key	10
Re-zero key	10
RECALL	47
Relative Humidity	5
Repeatability	69
Response adjustment	16
RS-232C	3, 8, 54
RTS line	56, 61

## S

S_	37
SD	37
Serial interface	3, 8
SI	37
SIF	32, 36, 37
SLOW	16
SPd	32, 34
ST	36
St-b	32, 34
Static electricity	6
Step card	8
Stop bit	54

Stream Mode	35
Symbol	9

## T

t	11
t-UP	32
Tael	11
Target weight	18
Temperature	69
temperature	5
Temperature difference	6
Title block	40
TL	11
Tola	11
t-r-c	32, 34
Troy Ounce	11
Tweezers	6
tYPE	32, 36, 37

## U

Underhook	49
Unit, Unit	9, 10, 11, 32
US	36

## V

vibration	16
-----------	----

## W

Weighing	13
Weighing capacity	69
Weighing chamber	8
Weighing pan	8
weight	18
WT	36