

ControlNet™

Interface for 520, 720i®, 820i® and 920i® Indicators

Installation and Programming Manual



ControlNet™

RICE LAKE®
WEIGHING SYSTEMS
To be the best by every measure®

Contents

About This Manual	1
1.0 Introduction.....	1
2.0 Installation.....	2
2.1 Installing the ControlNet Interface	2
2.1.1 Installing ControlNet Option in the 820i or 920i	2
2.1.2 Installing ControlNet Option in the 520	3
2.2 ControlNet Network Connections	3
2.3 Address and Termination Switches	3
2.4 LED Status Indicators	4
3.0 Commands.....	5
Decimal Point Handling	5
3.1 Output Command Format	5
Command number	5
Parameter value	6
Value	6
3.2 Input Command Format	6
Command number	6
Status Data	6
Value	7
3.3 Command Descriptions	7
Return Status and Current Weight as Integer	7
Display Channel	7
Display Gross Weight	7
Display Net Weight	7
Display Piece Count	7
Gross/Net Key Press (toggle mode)	7
Zero	7
Display Tare	7
Enter Tare (integer)	7
Acquire Tare (simulate TARE key press)	7
Clear Tare	7
Primary Units	7
Secondary Units	7
Tertiary Units	8
Units Key Press (toggle units)	8
Print Request	8
Display Accumulator	8
Clear Accumulator	8
Push Weight to Accumulator	8
Return Gross as Integer	8
Return Net as Integer	8
Return Tare as Integer	8



Technical training seminars are available through Rice Lake Weighing Systems. Course descriptions and dates can be viewed at www.ricelake.com/training or obtained by calling 715-234-9171 and asking for the training department.

© 2010 Rice Lake Weighing Systems. All rights reserved. Printed in the United States of America.

Specifications subject to change without notice.

Rice Lake Weighing Systems is an ISO 9001 registered company.

May 2010

Return Piece Count	8
Return Current Display as Integer	8
Return Accumulator as Integer	8
Return Rate of Change as Integer	8
Return Peak as Integer	8
Set Batching State	8
Batch Start	9
Batch Pause	9
Batch Reset	9
Batch Status	9
Lock Front Panel of Indicator	9
Unlock Front Panel of Indicator	9
Set Digital Output ON	9
Set Digital Output OFF	9
Read Digital I/O	9
User Command Enable	9
No Operation	9
Reset Indicator	9
Return Status and Current Weight as Float	9
Set Tare as Float	10
Read Gross Weight as Float	10
Read Net Weight as Float	10
Read Tare as Float	10
Read Piece Count as Float	10
Read Current Display as Float	10
Read Accumulator as Float	10
Read Rate of Change as Float	10
Read Peak Value as Float	10
Set Setpoint Value as Float	10
Set Setpoint Hysteresis as Float	10
Set Setpoint Bandwidth as Float	10
Set Setpoint Preact as Float	10
Read Setpoint Value as Float	10
Read Setpoint Hysteresis as Float	11
Read Setpoint Bandwidth as Float	11
Read Setpoint Preact as Float	11
Set Register	11
Get Register	11
4.0 Appendix	12
4.1 EDS File	12
4.2 Configuration Example	14
4.3 Ladder Logic Example	15
4.4 ControlNet Interface Specifications	16
ControlNet Interface Limited Warranty	17



Rice Lake continually offers web-based video training on a growing selection of product-related topics at no cost. Visit www.ricelake.com/webinars.

About This Manual

This manual provides information needed to install and use the Rice Lake Weighing Systems ControlNet Interface. The ControlNet™ Interface allows 520, 720i®, 820i®, and 920i® indicators to communicate with a master controller on a ControlNet network.¹ See the 520, 720i, 820i, or 920i *Installation Manual* for additional installation information and detailed descriptions of indicator functions.

-
1. ControlNet™ is a trademark of ControlNet International.

The ControlNet Interface is installed inside the indicator enclosure. Installation in NEMA 4X stainless steel enclosures permits use in washdown environments.



Warning

Some procedures described in this manual require work inside the indicator enclosure. These procedures are to be performed by qualified service personnel only.



Authorized distributors and their employees can view or download this manual from the Rice Lake Weighing Systems distributor site at www.ricelake.com.

1.0 Introduction

The ControlNet Interface returns weight and status information from a 520, 720i, 820i, or 920i indicator to a master controller and provides limited control of indicator functions to the programmer. Indicator configuration and calibration cannot be performed through the ControlNet Interface.

The ControlNet Interface functions as a Communications Adapter Device (profile 12) on a ControlNet network. It acts as a group-two-only server on the network. At this time only one polled I/O connection is supported.

The master controller sends commands to the indicator through the ControlNet Interface by writing the commands in the output command format. The ControlNet Interface returns the weight and status data in the input command format. These actions are referred to as polled I/O. See Section 3.0 for descriptions of the polled I/O commands.

2.0 Installation

The ControlNet Interface hardware consists of a dual-board option card. ControlNet-specific functions are provided by a ControlNet module, which is factory-installed onto a bus adapter card. The bus adapter card plugs into an open option card slot on the 520, 820i, or 920i CPU board (or expansion board) and provides power and access from the indicator bus to the ControlNet module.

This section describes the procedures used to install the ControlNet Interface into the 520, 820i, and 920i indicators, connect communications cables, and set the ControlNet address DIP switches on the module.

2.1 Installing the ControlNet Interface

Use the following procedure to install the ControlNet Interface into 520, 820i, and 920i indicators.

2.1.1 Installing ControlNet Option in the 820i or 920i

Use the following procedure to install the ControlNet Interface in the 720i, 820i or 920i indicator:

1. Disconnect indicator from power source.

Disconnect power before removing indicator backplate.

Warning The 720i, 820i and 920i have no on/off switch. Before opening the unit, ensure the power cord is disconnected from the power outlet.

2. Open indicator enclosure. For indicator models with backplates, place indicator face-down on an antistatic work mat. Remove screws that hold the backplate to the enclosure body.

Caution Use a wrist strap to ground yourself and protect components from electrostatic discharge (ESD) when working inside the indicator enclosure.

3. Carefully align the large connector (J1) on the bus adapter card with connector J12 on the 720i, J6 on the 820i, or J5 on the 920i CPU board (see Figure 2-1). Press down to seat the bus adapter card in the CPU board connector.
4. Use the screws and lockwashers provided in the option kit to secure the other end of the option card to the threaded standoffs on the CPU board.
5. Wire the card to the network as described in Section 2.2 on page 3.
6. Set DIP switch as described in Section 2.3 on page 3.
7. Use cable ties to secure loose cables inside the enclosure.

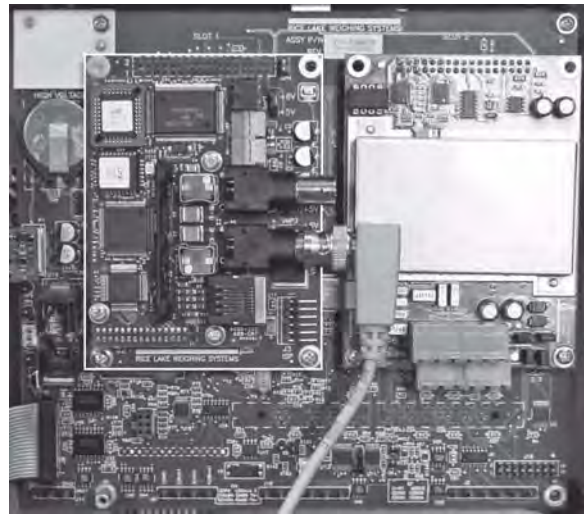

Figure 2-1. ControlNet Card (Card Edge Highlighted) Installed in 920i, Slot 1 (Connector J5).

8. For indicator models that include a backplate, position the backplate over the enclosure and reinstall the backplate screws. For the 820i or 920i universal models, use the torque pattern shown in Figure 2-2 to prevent distorting the backplate gasket. Torque screws to 15 in-lb (1.7 N-m).

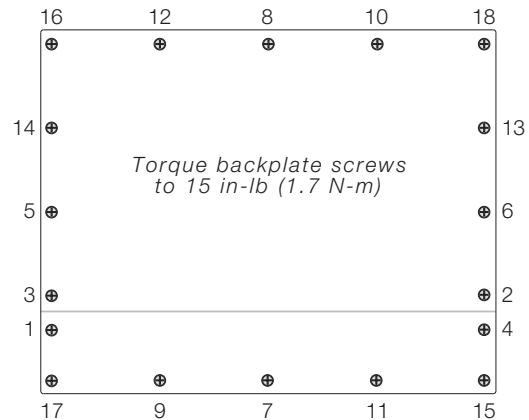

Figure 2-2. 820i/920i Enclosure Backplate

9. Ensure no excess cable is left inside the enclosure and tighten cord grips.
10. Reconnect power to the indicator. The indicator automatically recognizes all installed option cards when the unit is powered on. No hardware-specific configuration is required to identify the newly-installed ControlNet Interface to the system.

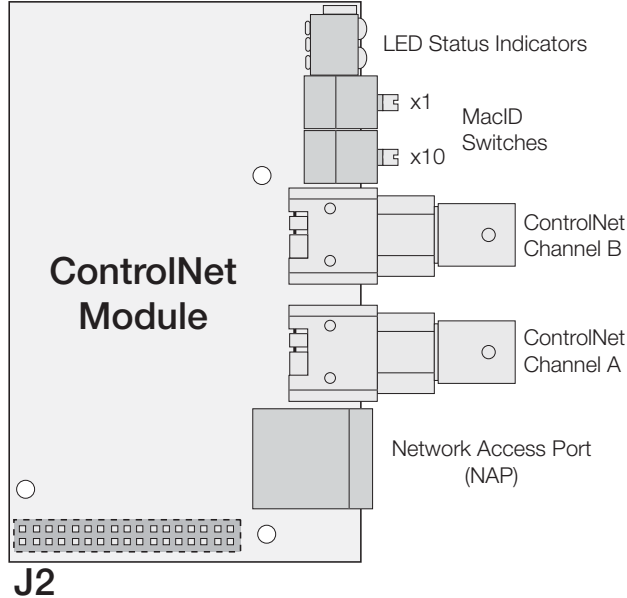

Figure 2-3. ControlNet Module

2.1.2 Installing ControlNet Option in the 520

Use the following procedure to install the ControlNet Interface in the 520 indicator:

1. Disconnect indicator from power source.



Warning

Disconnect power before removing indicator enclosure cover.

The 520 has no on/off switch. Before opening the unit, ensure the power cord is disconnected from the power outlet.

2. Place indicator on an antistatic work mat. Remove screws that hold the enclosure cover to the enclosure body.



Caution

Use a wrist strap to ground yourself and protect components from electrostatic discharge (ESD) when working inside the indicator enclosure.

3. Carefully align the large option card connector with connector J2 on the CPU board. Press down to seat the option card in the CPU board connector.
4. Use screws provided in the option kit to secure the other end of the option card to the threaded standoffs on the CPU board.
5. Route cables through cover supplied with the option kit.
6. Reconnect power to the indicator.
7. The indicator automatically recognizes all installed option cards when the unit is powered on. No hardware-specific configuration is required to identify the

newly-installed ControlNet interface to the system.

2.2 ControlNet Network Connections

The ControlNet module includes the following connectors:

- Network Access Port (NAP), for temporary diagnostic or configuration access
- Two BNC connectors for ControlNet Channels A and B

Feed ControlNet network cables through cord grip (720i, 820i and 920i) or through the special cover supplied for the 520. Allow enough cable for routing along inside of enclosure to connector on the ControlNet module. Connect network cables to connector on the ControlNet module (see Figure 2-3), then use cable ties to secure network cables to the cable tie mounts.

2.3 Address and Termination Switches

The ControlNet Interface address is set using switches on the Profibus module. Figure 2-4 shows the address and termination switches.

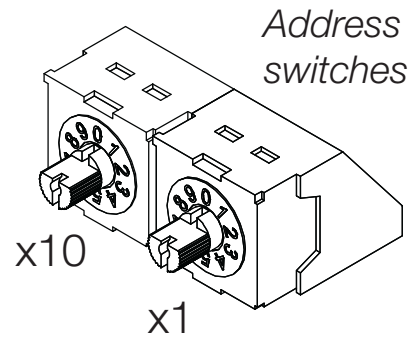

Figure 2-4. ControlNet Module Address Switches

Address Switches

Two rotary switches are used to set the decimal node address, 1–99, of the ControlNet Interface (use Address 0 if configuring the address in software.) Note that the node address cannot be changed during operation.

The left switch shown in Figure 2-4, marked $x10$, sets the tens digit; the right switch, $x1$, sets the units digit. (For example, to set a decimal address of 14, set $x10 = 1$, and $x1 = 4$.)

2.4 LED Status Indicators

An LED array on the ControlNet module provides status information for troubleshooting. LED 1 provides module status; LED 2 provides status information for both Channel A and B; LED 3 provides status information that can apply to either channel; LED 4 indicates the presence of a network connection to the module.

Table 2-1 on page 4 summarizes the function of the module and network status LEDs.

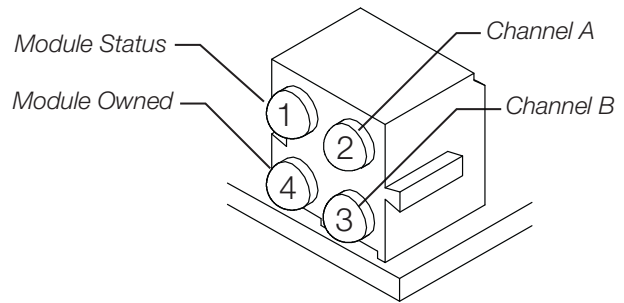

Figure 2-5. ControlNet Status LED Module

LED	Status	Description
LED 1 Module Status	Steady Green	Connection in run state
	Flashing Green	Connecting, connection idle
	Steady Red	Major fault
	Flashing Red	Minor fault
LED 2 Channel A and B	Off	Module not initialized
	Steady Red	Major fault
	Flashing Red	Node configuration error
	Alternating Red/Green	Self-test
LED 3 Channel A or B	Off	Channel disabled
	Steady Green	Normal channel operation
	Flashing Green	Temporary error (node will self-correct) or not configured
	Flashing Red	No other nodes, or media fault
	Alternating Red/Green	Network configuration error
LED 4 Module Owned	Off	No connection opened
	Steady Green	Connection opened

Table 2-1. Module and Network Status LED Indications

A single bi-color watchdog LED on the surface of the ControlNet module provides diagnostic information for debugging the module itself. Table 2-2 lists the indications provided by the debugging LED.

Status	Description
Off	No power
Red, 4Hz	DPRAM check fault
Red, 2Hz	ASIC and FLASH ROM check fault
Red, 1Hz	RAM check fault
Green, 2Hz	Module not initialized
Green, 1Hz	Module initialized and running

Table 2-2. Debugging LED Indications

3.0 Commands

Commands are used by the ControlNet master device to send and receive data from the ControlNet Interface as integer or floating-point data. The master sends eight bytes in the output format (used to write commands to the indicator) and reads eight bytes in the input format (used to read data from the indicator).

Decimal Point Handling

Integer commands return no decimal point information to the master. For example, a value of 750.1 displayed on the indicator is returned to the master as 7501. Floating point commands support decimal point information with no special handling.

3.1 Output Command Format

To perform a command, the master uses the output command format to send four 16-bit words to the ControlNet Interface. These four words contain the command and any parameters necessary to execute it. The output command format is shown in Table 3-1.

Word	Description
Word 1	Command number
Word 2	Parameter
Word 3	Value (MSW)
Word 4	Value (LSW)

Table 3-1. Output Command Format

The contents of each output command format word are described below:

Command number

The number representing the indicator command is sent in the first word. Table 3-2 lists the commands that can be specified for 520, 820i, and 920i indicators.

NOTE: A lockout feature that looks for any change in the output format data is incorporated into the indicator receive mechanism to prevent inundation by the same command. Repeated commands must be separated by any other valid command/parameter/value combination.

Decimal	Hex	Command
0	0x000	Return Status and Weight (integer)
1	0x001	Display Channel
2	0x002	Display Gross Weight
3	0x003	Display Net Weight
4	0x004	Display Count
9	0x009	Gross/Net key press (toggle)
10	0x00A	Zero
11	0x00B	Display Tare

Table 3-2. 520/720i/820i/920i Remote Commands

Decimal	Hex	Command
12	0x00C	Enter Tare
13	0x00D	Acquire Tare
14	0x00E	Clear Tare
16	0x010	Primary Units
17	0x011	Secondary Units
18	0x012	Tertiary Units
19	0x013	Units key press (toggle units)
20	0x014	Print Request
21	0x015	Display Accumulator
22	0x016	Clear Accumulator
23	0x017	Push Weight to Accumulator
32	0x020	Return Gross (integer)
33	0x021	Return Net (integer)
34	0x022	Return Tare (integer)
35	0x023	Return Count
37	0x025	Return Current Display (integer)
38	0x026	Return Accumulator (integer)
39	0x027	Return Rate of Change (integer)
40	0x028	Return Peak (integer)
95	0x05F	Set Batching State
96	0x060	Batch Start
97	0x061	Batch Pause
98	0x062	Batch Reset
99	0x063	Batch Status
112	0x070	Lock Indicator Front Panel
113	0x071	Unlock Indicator Front Panel
114	0x072	Set Digital Output ON
115	0x073	Set Digital Output OFF
116	0x074	Read Digital I/O Status
128	0x080	User Command Enable
253	0x0FD	No operation
254	0x0FE	Reset Indicator
256	0x100	Return Status as Weight (float)
268	0x10C	Set Tare (float)
288	0x120	Read Gross (float)
289	0x121	Read Net (float)
290	0x122	Read Tare (float)
291	0x123	Read Piece Count (float)
293	0x125	Read Current Display (float)
294	0x126	Read Accumulator (float)

Table 3-2. 520/720i/820i/920i Remote Commands

Decimal	Hex	Command
295	0x127	Read Rate of Change (float)
296	0x128	Read Peak (float)
304	0x130	Set Setpoint Value (float)
305	0x131	Set Setpoint Hysteresis (float)
306	0x132	Set Setpoint Bandwidth (float)
307	0x133	Set Setpoint Preact (float)
320	0x140	Read Setpoint Value (float)
321	0x141	Read Setpoint Hysteresis (float)
322	0x142	Read Setpoint Bandwidth (float)
323	0x143	Read Setpoint Preact (float)
368	0x170	Set Register
402	0x192	Get Register

Table 3-2. 520/720i/820i/920i Remote Commands

Parameter value

To allow communication with a multi-scale indicator, the scale number is sent in the second word of the output command format. Zero (0) represents the current scale. Certain commands require a parameter other than a scale number, such as a slot number, setpoint number, or other selection parameter. See the command descriptions in Section 3.3 for specific command requirements.

Value

The third and fourth words of the output format are used to pass value data on certain commands. Values entered in these words are treated as unsigned long integers or floating-point values, depending on the command.

3.2 Input Command Format

In response to a command, the ControlNet Interface returns data and status information to the master as four 16-bit words. This information is returned in the input command format shown in Table 3-3.

The value type can be set for those commands that do not specify integer or floating point data by sending a command 0x000 to specify integer data or command 0x100 for floating-point data. The value type is returned in the status word (bit 14) of the input format.

Word	Description
Word 1	Command number
Word 2	Status
Word 3	Value (MSW)
Word 4	Value (LSW)

Table 3-3. Input Command Format

Command number

The first word echoes the command number. If the command fails or is not recognized, the negative of the command number is returned to signal the error.

Status Data

Indicator status data is returned in the second word (see Table 3-4). Batch commands return batch status in place of the low byte (see Table 3-5). Setpoint commands return batch status in the low byte of the status word and the setpoint number in the high byte.

Word 2 Bit	Indicator Status Data	
	Value=0	Value=1
00	Error	No error
01	Tare not entered	Tare entered
02	Not zero	Center of zero
03	Weight invalid	Weight OK
04	Standstill	In motion
05	Primary units	Other units
06	Tare not acquired	Tare acquired
07	Gross weight	Net weight
08	Channel number (NOTE: Value 0 represents scale #32)	
09		
10		
11		
12		
13	Not used	
14	Integer data	Floating point data
15	Positive weight	Negative weight

Table 3-4. Indicator Status Data Format

Word 2 Bit	Batch Function Status Data	
	Value=0	Value=1
00	Digital input 4 OFF (520) Error	Digital input 4 ON (520) No error
01	Digital input 3 OFF	Digital input 3 ON
02	Digital input 2 OFF	Digital input 2 ON
03	Digital input 1 OFF	Digital input 1 ON
04	Batch not paused	Batch paused
05	Batch not running	Batch running
06	Batch not stopped	Batch stopped
07	Alarm OFF	Alarm ON

Table 3-5. Batch Function Status Data Format

Value

Weight data is returned to the master in the third and fourth words of the input command format, depending on the command and the value type. The weight data returned is the displayed weight after the command is executed, unless the command specifies otherwise.

3.3 Command Descriptions

NOTE: For all commands that require a scale number, a value of 0 indicates the current scale. Unless otherwise specified, the indicator returns weight and status data for the specified scale.

Return Status and Current Weight as Integer

Command: 0, 0x000

Parameter: Scale number

Command 0 returns the status and weight of the specified scale in integer format, without changing the display. This command also causes the format-independent commands to return a value in the integer format.

Display Channel

Command: 1, 0x001

Parameter: Scale number

Command 1 causes the weight of the specified scale to be displayed and returned in its current mode and format. This command is valid for the 920i only.

Display Gross Weight

Command: 2, 0x002

Parameter: Scale number

Command 2 causes the gross weight of the specified scale to be displayed and returned.

Display Net Weight

Command: 3, 0x003

Parameter: Scale number

Command 3 causes the net weight of the specified scale to be displayed and returned.

Display Piece Count

Command: 4, 0x004

Parameter: Scale number

Command 4 causes the piece count on the specified scale to be displayed and returned. This command is valid only for the 520 indicator, and only if count mode is enabled.

Gross/Net Key Press (toggle mode)

Command: 9, 0x009

Parameter: Scale number

Command 9 toggles between gross and net mode (and count mode, if enabled). If a scale number other than 0 is specified, the action may not be evident until the specified scale is displayed.

Zero

Command: 10, 0x00A

Command 10 performs a zero operation on the current scale.

Display Tare

Command: 11, 0x00B

Parameter: Scale number

Command 11 causes the tare weight on the specified scale to be displayed. If a scale number other than 0 is specified, the indicator first causes the specified scale to be displayed. The tare data continues being returned even if the display times out and returns to another mode.

Enter Tare (integer)

Command: 12, 0x00C

Parameter: Scale number

Value: Tare weight

Command 12 enters a tare for the scale selected. Tare data must be in integer format. The indicator continues to return weight data in the current mode for the specified scale.

Acquire Tare (simulate TARE key press)

Command: 13, 0x00D

Parameter: Scale number

Command 13 acquires a tare based on the weight currently on the specified scale. The indicator continues to return weight data in the current mode for the specified scale.

Clear Tare

Command: 14, 0x00E

Parameter: Scale number

Command 14 clears the tare for the specified scale. The indicator continues to return weight data in the current mode for the specified scale.

Primary Units

Command: 16, 0x010

Parameter: Scale number

Command 16 switches the current format of the specified scale to the primary units configured for that scale.

Secondary Units

Command: 17, 0x011

Parameter: Scale number

Command 17 switches the current format of the specified scale to the secondary units configured for that scale.

Tertiary Units

Command: 18, 0x012

Parameter: Scale number

Command 18 switches the current format of the specified scale to the tertiary units configured for that scale, if available. This command is valid for the *720i*, *820i* or *920i* only.

Units Key Press (toggle units)

Command: 19, 0x013

Parameter: Scale number

Command 19 toggles the current format of the specified scale to the next units configured for that scale, as available.

Print Request

Command: 20, 0x014

Parameter: Scale number

Command 20 causes the indicator to execute a print command for the current scale.

Display Accumulator

Command: 21, 0x015

Parameter: Scale number

Command 21 causes the value of the accumulator for the specified scale to be displayed and returned. This command is only valid if the accumulator for the specified scale is enabled.

Clear Accumulator

Command: 22, 0x016

Parameter: Scale number

Command 22 clears the value of the accumulator for the specified scale. This command is only valid if the accumulator for the specified scale is enabled.

Push Weight to Accumulator

Command: 23, 0x017

Parameter: Scale number

Command 23 adds the net weight on the specified scale to the value of the accumulator for the specified scale. The scale must return to net zero between accumulations. The indicator returns the accumulated weight data for the specified scale. This command is only valid if the accumulator for the specified scale is enabled.

Return Gross as Integer

Command: 32, 0x020

Parameter: Scale number

Command 32 returns the gross weight value for the specified scale as an integer.

Return Net as Integer

Command: 33, 0x021

Parameter: Scale number

Command 33 returns the net weight value for the specified scale as an integer.

Return Tare as Integer

Command: 34, 0x022

Parameter: Scale number

Command 34 returns the tare weight value for the specified scale as an integer.

Return Piece Count

Command: 35, 0x023

Parameter: Scale number

Command 35 returns the piece count value for the specified scale. This command is valid only for the *520* indicator, and only if count mode is enabled.

Return Current Display as Integer

Command: 37, 0x025

Parameter: Scale number

Command 37 returns the weight value for the specified scale as currently displayed. This may include gross, net, tare, piece count, or accumulator values, as enabled. On the *820i* and *920i*, the weight value is returned in the mode used to display a scale widget.

Return Accumulator as Integer

Command: 38, 0x026

Parameter: Scale number

Command 38 returns the accumulator value for the specified scale. This command is only valid if the accumulator for the specified scale is enabled.

Return Rate of Change as Integer

Command: 39, 0x027

Parameter: Scale number

Command 39 returns the current rate of change value for the specified scale. This command is valid only for the *720i*, *820i* and *920i*.

Return Peak as Integer

Command: 40, 0x028

Parameter: Scale number

Command 40 returns the net peak value for the specified scale. This command is valid only for the *520* indicator, and only if the peak hold function is enabled.

Set Batching State

Command: 95, 0x05F

Parameter: State (0 = off; 1 = auto; 2 = manual)

Command 95 sets the batching (BATCHNG) parameter. Indicator status is returned with the current weight for the last scale specified.

Batch Start

Command: 96, 0x060

Parameter: Scale number

Command 96 starts a batch program from the current step after a stop, pause, or reset. Batch status is returned with the current weight for the specified scale.

Batch Pause

Command: 97, 0x061

Parameter: Scale number

Command 97 pauses a batch program at the current step. Batch status is returned with the current weight for the specified scale.

Batch Reset

Command: 98, 0x062

Parameter: Scale number

Command 98 stops a batch program and resets it to the first batch step. Batch status is returned with the current weight for the specified scale.

Batch Status

Command: 99, 0x063

Parameter: Scale number

Command 99 returns the status of a batch. Batch status is returned with the current weight for the specified scale.

Lock Front Panel of Indicator

Command: 112, 0x070

Parameter: Scale number

Command 112 disables all the keys on the front panel of the indicator. Indicator status is returned with the current weight for the specified scale.

Unlock Front Panel of Indicator

Command: 113, 0x071

Parameter: Scale number

Command 113 re-enables all the keys on the front panel of the indicator. Indicator status is returned with the current weight for the specified scale.

Set Digital Output ON

Command: 114, 0x072

Parameter: Slot number

Value: Bit number

Command 114 sets the specified digital output ON (active). Use slot number 0 for onboard digital outputs. Indicator status is returned with the current weight for the last scale specified.

Set Digital Output OFF

Command: 115, 0x073

Parameter: Slot number

Value: Bit number

Command 115 sets the specified digital output OFF (inactive). Use slot number 0 for onboard digital outputs. Indicator status is returned with the current weight for the last scale specified.

Read Digital I/O

Command: 116, 0x074

Parameter: Slot number

Command 116 returns the status for all digital I/O in the specified slot in words 3 and 4 (On the 520, status is returned only for the digital inputs.) Use slot number 0 for onboard digital I/O. Indicator status is returned in the status area for the last scale specified.

User Command Enable

Command: 128, 0x080

Parameter: None

For the 920i only, command 128 enables the BusCommand handler to allow data transfers to the PLC of from 1 to 64 words. When the BusCommand handler is enabled, all discrete transfer commands are disabled and ignored.

Use `DisableHandler(BusCommand)` ; in the 920i user program to turn off the BusCommand handler.

No Operation

Command: 253, 0x0FD

Parameter: Scale number

Command 253 provides a command to use between operations, as necessary, without causing the indicator to perform any action. Indicator status and weight for the specified scale is returned.

Reset Indicator

Command: 254, 0x0FE

Parameter: None

Command 254 provides a command to remotely reset the indicator. No data is returned.

Return Status and Current Weight as Float

Command: 256, 0x100

Parameter: Scale number

Command 256 returns the status and weight of the specified scale in floating-point format, without changing the display. This command also causes the format-independent commands to return a value in the floating-point format.

Set Tare as Float

Command: 268, 0x10C
Parameter: Scale number
Value: Tare weight

Command 268 enters a tare for the scale selected in floating-point format. The indicator returns the tare weight as taken, or 0 for no tare.

Read Gross Weight as Float

Command: 288, 0x120
Parameter: Scale number

Command 288 returns the gross weight value for the specified scale in floating-point format.

Read Net Weight as Float

Command: 289, 0x121
Parameter: Scale number

Command 289 returns the net weight value for the specified scale in floating-point format.

Read Tare as Float

Command: 290, 0x122
Parameter: Scale number

Command 290 returns the tare weight value for the specified scale in floating-point format.

Read Piece Count as Float

Command: 291, 0x123
Parameter: Scale number

Command 291 returns the piece count value for the specified scale in floating-point format. This command is only valid for the 520, and only if count mode is enabled.

Read Current Display as Float

Command: 293, 0x125
Parameter: Scale number

Command 293 returns the weight value for the specified scale as currently displayed in floating-point format. This may include gross, net, tare, piece count, rate-of-change, or accumulator values, as enabled. On the 920i, the weight value is returned in the mode used to display a scale widget.

Read Accumulator as Float

Command: 294, 0x126
Parameter: Scale number

Command 294 returns the accumulator value for the specified scale in floating-point format. This command is only valid if the accumulator for the specified scale is enabled.

Read Rate of Change as Float

Command: 295, 0x127
Parameter: Scale number

Command 295 returns the current rate of change value for the specified scale in floating-point format. This command is only valid for the 820i or 920i.

Read Peak Value as Float

Command: 296, 0x128
Parameter: Scale number

Command 296 returns the net peak value for the specified scale in floating-point format. This command is only valid for the 520, and only if the peak hold function is enabled.

Set Setpoint Value as Float

Command: 304, 0x130
Parameter: Setpoint number
Value: Target value

Command 304 sets the target value for the specified setpoint in floating-point format. This command is only valid if the setpoint is enabled and requires a target value.

Set Setpoint Hysteresis as Float

Command: 305, 0x131
Parameter: Setpoint number
Value: Hysteresis value

Command 305 sets the hysteresis value for the specified setpoint in floating-point format. This command is only valid if the setpoint is enabled and requires a hysteresis value.

Set Setpoint Bandwidth as Float

Command: 306, 0x132
Parameter: Setpoint number
Value: Bandwidth value

Command 306 sets the bandwidth value for the specified setpoint in floating-point format. This command is only valid if the setpoint is enabled and requires a bandwidth value.

Set Setpoint Preact as Float

Command: 307, 0x133
Parameter: Setpoint number
Value: Preact value

Command 307 sets the preact value for the specified setpoint in floating-point format. This command is only valid if the setpoint is enabled and requires a preact value.

Read Setpoint Value as Float

Command: 320, 0x140
Parameter: Setpoint number

Command 320 returns the target value for the specified setpoint in floating-point format. This command is only valid if the setpoint is enabled and requires a target value.

Read Setpoint Hysteresis as Float

Command: 321, 0x141

Parameter: Setpoint number

Command 321 returns the hysteresis value for the specified setpoint in floating-point format. This command is only valid if the setpoint is enabled and requires a hysteresis value.

Read Setpoint Bandwidth as Float

Command: 322, 0x142

Parameter: Setpoint number

Command 322 returns the bandwidth value for the specified setpoint in floating-point format. This command is only valid if the setpoint is enabled and requires a bandwidth value.

Read Setpoint Preact as Float

Command: 323, 0x143

Parameter: Setpoint number

Command 323 returns the preact value for the specified setpoint in floating-point format. This command is only valid if the setpoint is enabled and requires a preact value.

Set Register

Command: 368

Registers: 1 thru 256

Command 368 sets register value. 1 through 128 are integer and 129 through 256 are real. This command is only valid for the *720i* PCE version.

Get Register

Command: 402

Registers: 1 thru 256

Command 402 returns register value. 1 through 128 are integer and 129 through 256 are real. This command is only valid for the *720i* PCE version.

4.0 Appendix

4.1 EDS File

The EDS file for the ControlNet adapter, shown below, is included on the CD that comes with the option. The EDS file must be installed in the host device to enable communication with the indicator.

[File]

```
DescText    = "AnyBus-S ControlNet";
CreateDate  = 07-19-1999;
CreateTime  = 11:11:51;
ModDate     = 03-10-2004;
ModTime     = 15:00:00;
Revision    = 1.7;
```

[Device]

```
VendCode    = 90;
VendName    = "HMS Networks";
ProdType    = 12;
ProdTypeStr = "Communication Adapter";
ProdCode    = 1;
MajRev     = 1;
MinRev     = 50;
ProdName    = "Anybus-S ControlNet";
Catalog     = "Anybus-S ControlNet";
```

[Device Classification]

```
Class1 = 1_RSNetWorx_Adapter;
Class2 = ControlNet;
```

[Port]

```
Port1 = ControlNet_Redundant,
       "Port A",
       "20 F0 24 01",
       2;
```

[Params]

```
Param2 =
  0,          $ first field shall equal 0
  ,,         $ path size,path
  0x0000,    $ descriptor
  199,       $ data type : 16-bit Unsigned Integer
  2,         $ data size in bytes
  "Output Size", $ name
  "",       $ units
  "",       $ help string
  0,450,16, $ min,max,default data values
  0,0,0,0, $ mult,dev,base,offset scaling not used
  0,0,0,0, $ mult,dev,base,offset link not used
  0;        $ decimal places not used
```



```

Param3 =
  0,          $ first field shall equal 0
  ,,         $ path size,path
  0x0000,    $ descriptor
  199,       $ data type : 16-bit Unsigned Integer
  2,         $ data size in bytes
  "Input Size", $ name
  "",        $ units
  "",        $ help string
  4,454,20,  $ min,max,default data values
  0,0,0,0,   $ mult,dev,base,offset scaling not used
  0,0,0,0,   $ mult,dev,base,offset link not used
  0;

```

[Connection Manager]

```

Connection1 =
  0x04010002, $ trigger & transport
               $ 0-15 = supported transport classes (class 1)
               $ 16 = cyclic (1 = supported)
               $ 17 = change of state (0 = not supported)
               $ 18 = on demand (0 = not supported)
               $ 19-23 = reserved (must be zero)
               $ 24-27 = exclusive owner
               $ 28-30 = reserved (must be zero)
               $ 31 = client 0 (don't care for classes 0 and 1)
  0x44240405, $ point/multicast & priority & realtime format
               $ 0 = O=>T fixed (1 = supported)
               $ 1 = O=>T variable (0 = not supported)
               $ 2 = T=>O fixed (1 = supported)
               $ 3 = T=>O variable (0 = not supported)
               $ 4-7 = reserved (must be zero)
               $ 8-10 = O=>T header (4 byte run/idle)
               $ 11 = reserved (must be zero)
               $ 12-14 = T=>O header
               $ 15 = reserved (must be zero)
               $ 16-19 = O=>T point-to-point
               $ 20-23 = T=>O multicast
               $ 24-27 = O=>T scheduled
               $ 28-31 = T=>O scheduled
  ,Param2,,   $ O=>T RPI,Size,Format
  ,Param3,,   $ T=>O RPI,Size,Format
  ,,         $ config part 1 (dynamic assemblies)
  ,,         $ config part 2 (module configuration)
  "Discrete Exclusive Owner", $ connection name
  "",        $ Help string
  "20 04 24 01 2C 96 2C 64"; $ exclusive output path

```

```
1_PLC5C_RTD_Format1 = 1_PLC5C_1794_Discrete_RTD_Format;
```

4.2 Configuration Example

The following figure shows an example Scanlist Configuration display for RSNetWorx™. Note that, when configuring the ControlNet adapter, the input size is set to 6, output to 4.

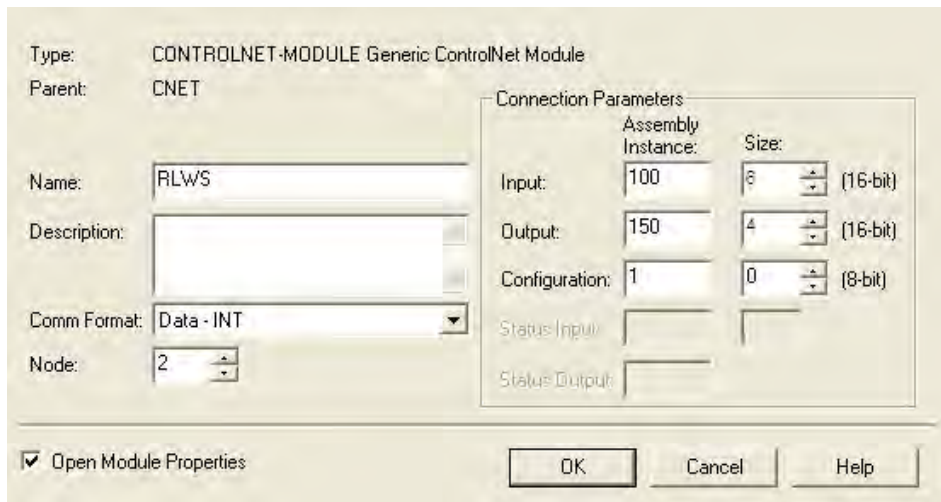
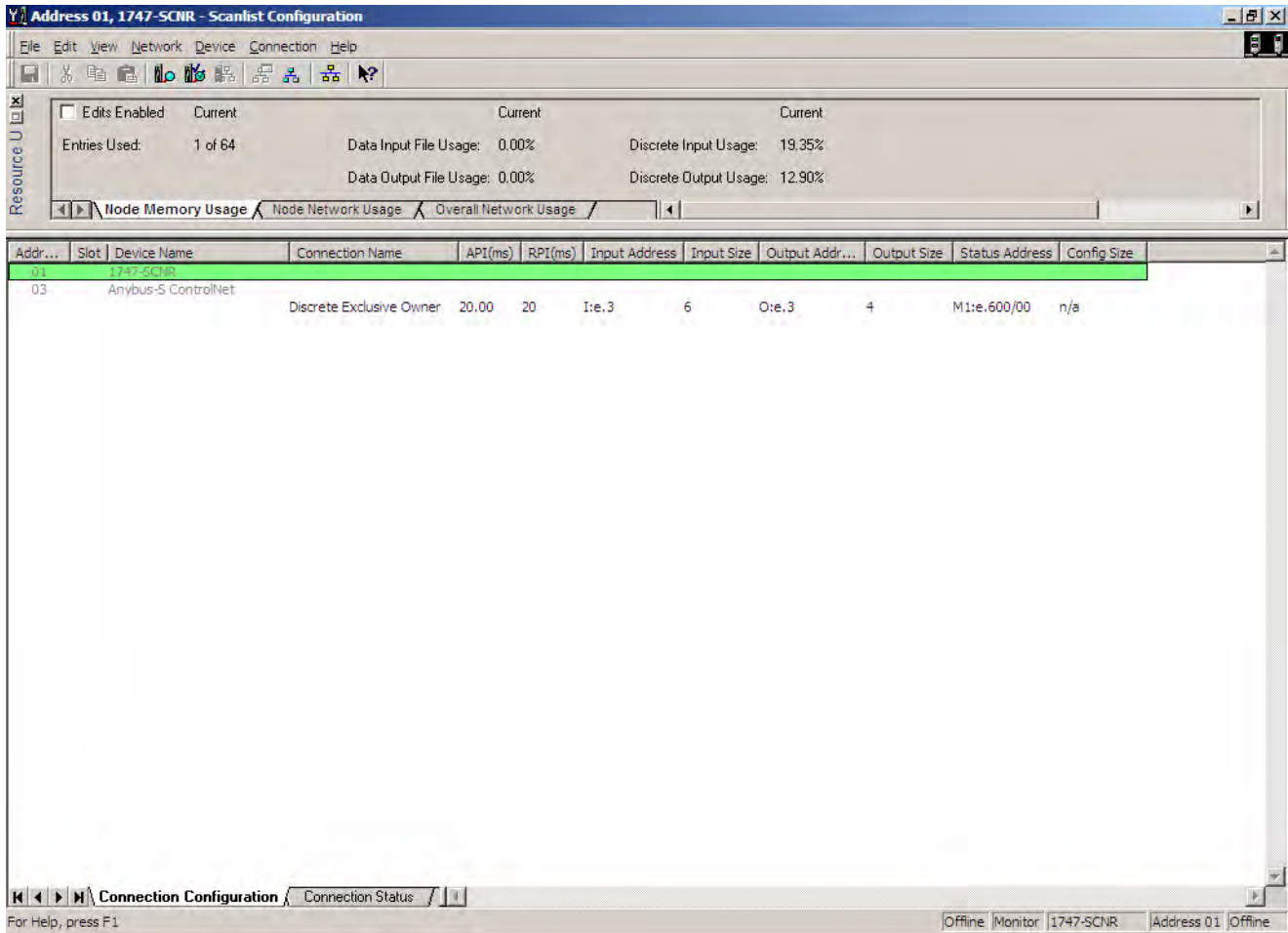

4.3 Ladder Logic Example

The following example shows the ladder logic used to retrieve and swap bytes to load a 4-word package for processing.

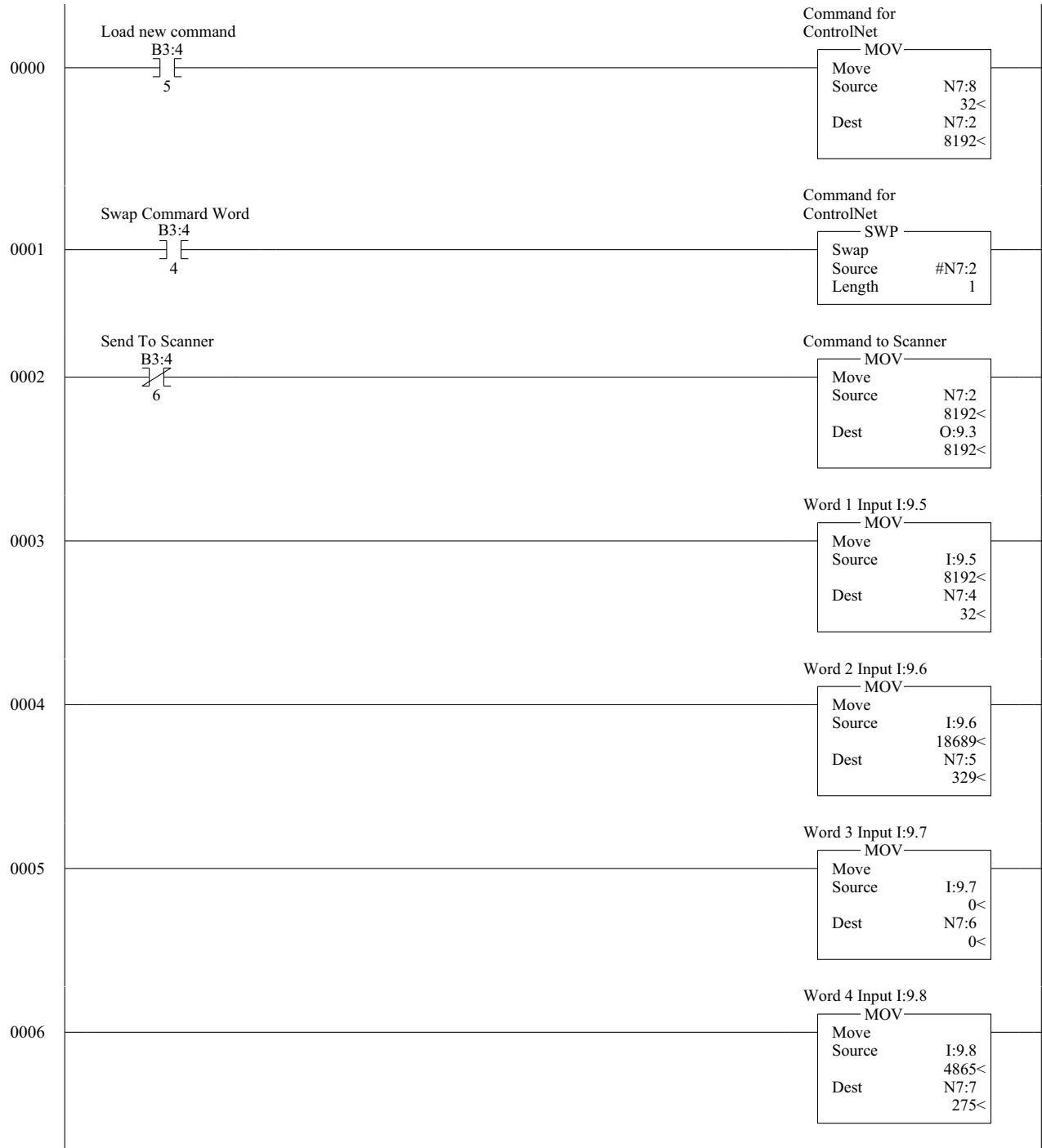



4.4 ControlNet Interface Specifications

Power Requirements

Bus Adapter Card with ControlNet Module, DC Power:

Supply voltage: 6 VDC, supplied by indicator bus

Typical current draw: 350 mA

Power consumption: 2.1 W

Indicators, Typical AC Load:

520 Power (TRMS): 3.51 W
Current (TRMS): 33.7 mA

820i Power (TRMS): 2.18 W
Current (TRMS): 28.9mA

920i Power (TRMS): 2.18 W
Current (TRMS): 28.9 mA

Communications Specifications

ControlNet RG-6 quad-shielded coaxial cable

Update rate is dependent on the configured baud rate and the number of network nodes. Maximum update rate is 20–24 per second.

Environmental Specifications

Temperature: -10° to +40° C (14° to 104° F)

Conformance



The ControlNet Interface has been tested for conformance to ControlNet communications adapter profile 12.

ControlNet Interface Limited Warranty

Rice Lake Weighing Systems (RLWS) warrants that all RLWS equipment and systems properly installed by a Distributor or Original Equipment Manufacturer (OEM) will operate per written specifications as confirmed by the Distributor/OEM and accepted by RLWS. All systems and components are warranted against defects in materials and workmanship for one year.

RLWS warrants that the equipment sold hereunder will conform to the current written specifications authorized by RLWS. RLWS warrants the equipment against faulty workmanship and defective materials. If any equipment fails to conform to these warranties, RLWS will, at its option, repair or replace such goods returned within the warranty period subject to the following conditions:

- Upon discovery by Buyer of such nonconformity, RLWS will be given prompt written notice with a detailed explanation of the alleged deficiencies.
- Individual electronic components returned to RLWS for warranty purposes must be packaged to prevent electrostatic discharge (ESD) damage in shipment. Packaging requirements are listed in a publication, "Protecting Your Components From Static Damage in Shipment," available from RLWS Equipment Return Department.
- Examination of such equipment by RLWS confirms that the nonconformity actually exists, and was not caused by accident, misuse, neglect, alteration, improper installation, improper repair or improper testing; RLWS shall be the sole judge of all alleged non-conformities.
- Such equipment has not been modified, altered, or changed by any person other than RLWS or its duly authorized repair agents.
- RLWS will have a reasonable time to repair or replace the defective equipment. Buyer is responsible for shipping charges both ways.
- In no event will RLWS be responsible for travel time or on-location repairs, including assembly or disassembly of equipment, nor will RLWS be liable for the cost of any repairs made by others.

THESE WARRANTIES EXCLUDE ALL OTHER WARRANTIES, EXPRESSED OR IMPLIED, INCLUDING WITHOUT LIMITATION WARRANTIES OF MERCHANTABILITY OR FITNESS FOR A PARTICULAR PURPOSE. NEITHER RLWS NOR DISTRIBUTOR WILL, IN ANY EVENT, BE LIABLE FOR INCIDENTAL OR CONSEQUENTIAL DAMAGES.

RLWS AND BUYER AGREE THAT RLWS' SOLE AND EXCLUSIVE LIABILITY HEREUNDER IS LIMITED TO REPAIR OR REPLACEMENT OF SUCH GOODS. IN ACCEPTING THIS WARRANTY, THE BUYER WAIVES ANY AND ALL OTHER CLAIMS TO WARRANTY.

SHOULD THE SELLER BE OTHER THAN RLWS, THE BUYER AGREES TO LOOK ONLY TO THE SELLER FOR WARRANTY CLAIMS.

NO TERMS, CONDITIONS, UNDERSTANDING, OR AGREEMENTS PURPORTING TO MODIFY THE TERMS OF THIS WARRANTY SHALL HAVE ANY LEGAL EFFECT UNLESS MADE IN WRITING AND SIGNED BY A CORPORATE OFFICER OF RLWS AND THE BUYER.

© 2010 Rice Lake Weighing Systems, Inc. Rice Lake, WI USA. All Rights Reserved.

RICE LAKE WEIGHING SYSTEMS • 230 WEST COLEMAN STREET • RICE LAKE, WISCONSIN 54868 • USA



230 W. Coleman St. • Rice Lake, WI 54868 • USA
U.S. 800-472-6703 • Canada/Mexico 800-321-6703
International 715-234-9171

www.ricelake.com

© 2010 Rice Lake Weighing Systems

PN 103122 05/10