

## Operating Instructions

# Entris

Laboratory Balances

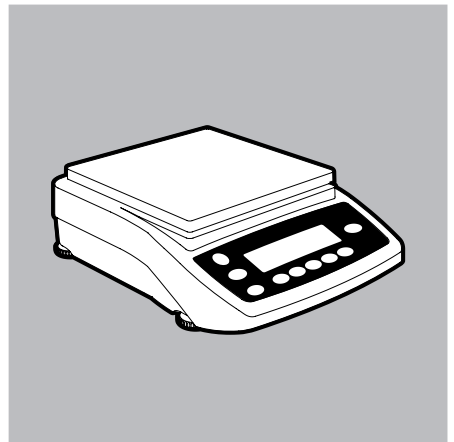
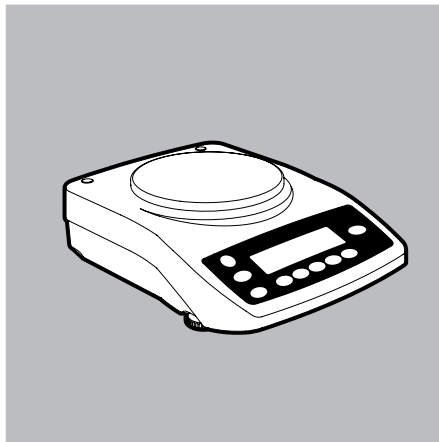
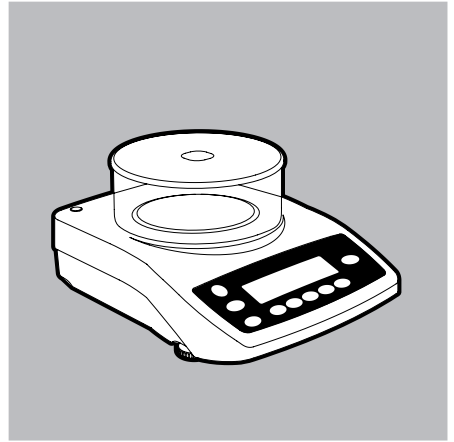
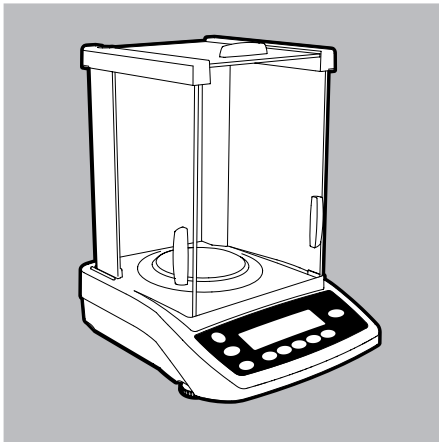

---

# User Information

## Warning | danger symbols used in these instructions:



These notes identify hazards which have a high probability of resulting in death or serious physical injury if not avoided.



These notes identify hazards that can result in moderate or mild injuries if not avoided.



These notes identify hazards associated with the risk of material damage.

---

### Explanation of Symbols

The following symbols are used in these instructions:

- ▶ Indicates a required action
- ▷ Describes what happens after you have performed a particular step

Perform steps in the specified order:

1. First action
  2. Second action
  3. ...
- Indicates an item in a list

Conventions for this User Manual:

- The illustrations in these instructions are based on “Standard” balances.

### Applications Advice | Technical Support

Addresses for applications advice and technical support can be found on the website at:

<http://www.sartorius.com>

---

# Contents

|   |    |
|---|----|
| <b>User Information</b> . . . . .                           | 2  |
| Explanation of Symbols . . . . .                            | 2  |
| Applications Advice   Technical Support . . . . .           | 2  |
| <b>Contents</b> . . . . .                                   | 3  |
| Intended Use . . . . .                                      | 3  |
| <b>Safety Instructions</b> . . . . .                        | 4  |
| <b>Getting Started</b> . . . . .                            | 5  |
| <b>Operation</b> . . . . .                                  | 10 |
| Display and Controls. . . . .                               | 10 |
| Basic Weighing Function . . . . .                           | 11 |
| Calibration . . . . .                                       | 12 |
| <b>Configuration (Operating Menu)</b> . . . . .             | 15 |
| Functions of the Keys in the Menu . . . . .                 | 15 |
| Menu Navigation;<br>Example: Setting the Language . . . . . | 16 |
| Menu: Structure. . . . .                                    | 17 |
| Menu Settings: Overview . . . . .                           | 18 |
| <b>Application Programs</b> . . . . .                       | 23 |
| Counting . . . . .  | 23 |
| Weighing in Percent. . . . .                                | 25 |
| Animal Weighing   Averaging . . . . .                       | 27 |
| Toggling Between Weight Units . . . . .                     | 29 |
| Density Determination . . . . .                             | 31 |
| <b>Data Interface</b> . . . . .                             | 34 |
| <b>Error Codes</b> . . . . .                                | 35 |
| <b>Care and Maintenance</b> . . . . .                       | 36 |
| <b>Disposal</b> . . . . .                                   | 37 |
| <b>Overview</b> . . . . .                                   | 38 |
| Specifications. . . . .                                     | 38 |
| Accessories. . . . .  | 42 |
| EC Declaration of Conformity . . . . .                      | 44 |

## Intended Use

This high-precision balance is designed to be used exclusively indoors under normal atmospheric conditions.

It was developed specifically for the exact determination of the mass of materials in liquid, paste, powder, or solid form. Appropriate containers must be used for each type of sample material.

# Safety Instructions

## Guidelines and General Information

- The balance complies with EU Directives and standards for electrical safety and electromagnetic compatibility\*. Improper use or handling can, however, result in damage and | or injury.  
Any improper use or operation of the balance, i.e., that is not consistent with the instructions, will result in forfeiture of all claims under the manufacturer's warranty.
- Personnel need to have read and understood these installation instructions, including the safety instructions.
- In the event of use in systems and ambient conditions which have greater safety requirements, you must observe the requirements and provisions applicable in your country.
- Always keep the equipment and balance freely accessible.  
Any installation work or balance operation that does not conform to the instructions will result in forfeiture of all claims under the manufacturer's warranty.

\* = see "Specifications"



### Danger of explosion

Do not use this equipment in hazardous areas in which explosive materials are present.



Make sure that the voltage rating printed on the AC adaptor is identical to your local mains voltage.



### Installation Instructions

Do not operate the device if the housing or AC adaptor is damaged. Immediately disconnect the damaged device from the power by pulling the plug.



Do not expose the balance, its power supply or accessories supplied by Sartorius to extreme temperatures, aggressive chemical vapors, moisture, shock, vibrations or strong electromagnetic fields.  
Observe the conditions of operation described in the "Technical Data"!



Note on Installation:  
The operator shall be solely responsible for any modifications to the equipment and for connecting any cables or equipment not supplied by Sartorius. Information on operational quality is available upon request from Sartorius. Only use original Sartorius accessories!

Note the IP protection class of the balance and its power supply!  
Do not allow liquid penetration. The protection class specifies the suitability of equipment for various environmental conditions (moisture, foreign bodies).



Before cleaning the AC adapter or the balance: Unplug the power cord.

The balance may only be opened by specialized personnel trained by Sartorius.  
Do not open the AC adaptor.



If glass breaks, there is a risk of injury posed by cuts on glass edges.



Lay the cables where they pose no risk of causing someone to trip.

Observe the additional safety and danger information in the following chapters.

---

# Getting Started

## Storage and Shipping Conditions

- Do not expose the balance to extreme temperatures, moisture, shocks, blows, or vibration.

## Unpacking the Equipment

- ▶ After unpacking the device, check it immediately for any external damage.
- ▷ If you detect any damage, proceed as directed in the “Care and Maintenance” chapter, “Safety Inspection” section.
- ▷ Save all parts of the original packaging for any future transportation. During shipment, please do not leave cables plugged in!

## Equipment Supplied

- Balance
- Weighing pan
- Pan support only for models with a round weighing pan
- Mains power supply unit

Additional equipment on the following models:

- Entris64-1S, Entris124-1S, Entris224-1S, Entris64i-1S, Entris124i-1S, Entris224i-1S
- Sliding panel draft shield
- Shield disk
- Shield plate
- Dust cover

Additional equipment on the following models:

- Entris153-1S, Entris323-1S, Entris423-1S, Entris623-1S, Entris153i-1S, Entris323i-1S, Entris423i-1S, Entris623i-1S
- Round glass draft shield (with shield plate and cover)

## Setup

Choose a location that is not subject to the following negative influences:

- Heat (heater or direct sunlight)
- Drafts from open windows and doors
- Extreme vibrations during weighing
- Extreme humidity

## Conditioning the Balance

Moisture in the air can condense on cold surfaces whenever the equipment is moved to a substantially warmer place. Allow the device to acclimatize for about 2 hours at room temperature, leaving it unplugged from the power supply.

# Installation

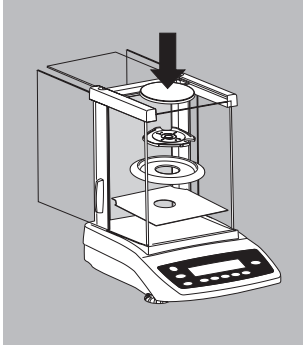

## Setting up the Balance

Balances with Sliding Panel Draft Shield

- ▶ Place the components listed below inside the weighing chamber in the order given:
  - Shield plate
  - Shield disk
  - Pan support
  - Weighing pan

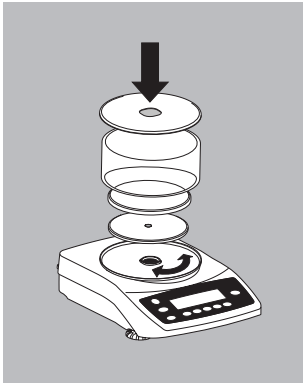

Balances with Round Glass Draft Shield

- ▶ Position the components listed below in the order given:
  - Place lid on top of the balance with the rim facing upwards and rotate until it is securely in place
  - Pan support
  - Weighing pan
  - Glass cover
  - Cover with the rim facing downwards

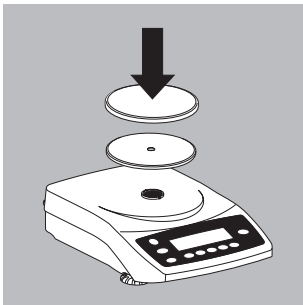

Balances with a Round Weighing Pan

- ▶ Position the components listed below in the order given:
  - Pan support
  - Weighing pan

Balances with a Rectangular Weighing Pan

- ▶ Place the weighing pan on the balance

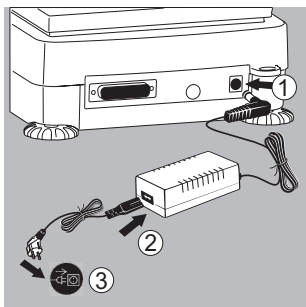

### Power Connection | Safety Precautions

- Use only an original AC adapter 6971991
- ▶ Insert the right-angle plug into the jack
- ▶ Select a country-specific power cable and attach to the AC adapter
- ▶ Connect the device to the power

Mains connecting lead:

| Item No. | Region   Country                       |
|----------|--|
| 6971953  | Europa   EU<br>(except United Kingdom) |
| 6971954  | USA   Canada   China   Japan           |
| 6971955  | United Kingdom                         |
| 6971956  | Australia, New Zealand                 |
| 6971957  | South Africa                           |
| 6971964  | India                                  |
| 6971998  | Brazil                                 |
| 6971999  | Argentina                              |
| 6900931  | South Korea                            |

### Safety Precautions

Desktop power supply 6971991:

An adaptor rated to Class 2 can be plugged into any wall outlet with no additional safety precautions required.

A ground or earth terminal is connected to the balance housing. The balance housing can be additionally grounded, if required for certain functions.

The data port is also galvanically linked to the balance housing (mass).

### Connecting Electronic Peripheral Devices

- ▶ Make sure that the balance is unplugged from the power supply before connecting | disconnecting a peripheral device (printer or PC) to or from the interface port.

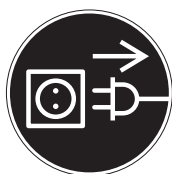

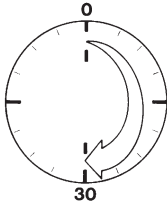

### Warm-up Time

In order to provide accurate results, the instrument must warm up for 30 minutes. Only after this time will the required operating temperature have been reached.

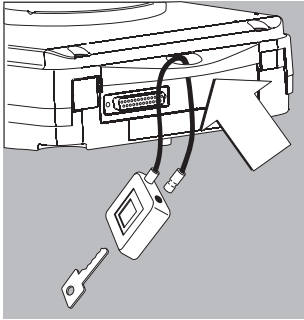

### Anti-theft Locking Device

To fasten an anti-theft locking device, use the lug located on the back of the balance.

- ▶ Secure the balance at the place of location, e.g., with a chain or a lock.



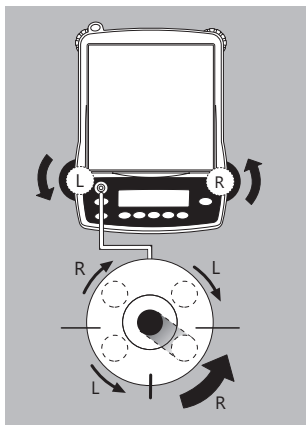

## Levelling the Balance

Purpose:

- To compensate for unevenness at the place of installation

Always level the balance again any time after it has been moved to a different location. Only the 2 front feet are used for leveling.

- ▶ Screw in both rear support feet (only on models with a rectangular weighing pan).
- ▶ Turn the front levelingfeet as shown in the illustration until the air bubble is centered within the circle of the level indicator.
- > Normally, several leveling steps are required.
- ▶ On models with a rectangular weighing pan: Screw out both back leveling feet until they touch the setup surface.

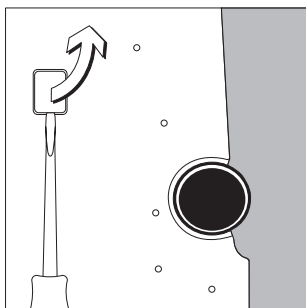

## Below-Cell Weighing

A port for a below-cell weighing hook is located on the bottom of the balance.

- ▶ Not permitted for applications in legal metrology.
- ▶ Lift cover plate out of the bottom of the balance. Attention: Place the balance on its side, do not turn over completely!
- ▶ Secure hook 1: Use a wire, for example, to suspend the sample on the hook.
- ▶ Install a draft shield if necessary.

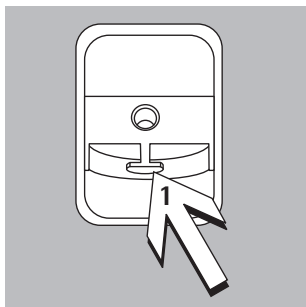

# Operation

## Overview of Display and Control Panel

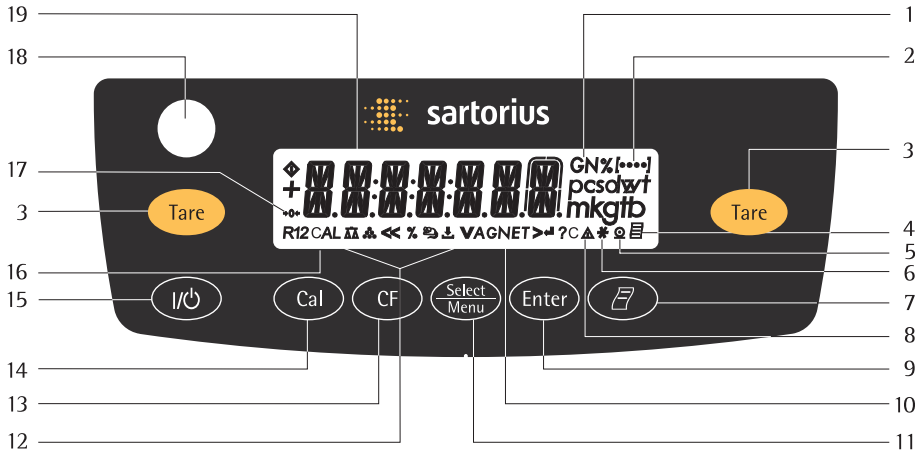

| Item | Description   |
|------|---|
| 1    | Weight units  |
| 2    | Displays the menu level   |
| 3    | Taring  |
| 4    | Symbol for “GLP printing mode active”   |
| 5    | Symbol for “Printing mode active”   |
| 6    | Application program active  |
| 7    | Data output:<br>Press this key to send readout values to the built-in data interface. |
| 8    | Calculated-value indicator: not a weight value  |
| 9    | Start the application program   |
| 10   | Symbol: Gross or net  |
| 11   | Select an application program   open the operating menu                               |
| 12   | Symbols for active application (ΔΔ, ∙∙, %, Ⓜ, ↓, A, C)                                |

| Item    | Description   |
|---------|---|
| 13      | Delete (Clear Function)<br>This key is generally used to cancel functions:<br>– Quit application program<br>– Cancel calibration   adjustment routine   Exit menu |
| 14      | Start calibration   adjustment routine  |
| 15      | On   Off  |
| 16      | Symbol: Calibration   adjustment function   |
| 17      | Symbols for “zero range« (verified models only)   |
| 18      | Level indicator   |
| 19      | Weight value displayed in selected weight unit  |
| Symbol: |   |
| <<      | Exit the operating menu   |
| <       | One menu level higher   |
| ∨       | Scroll through menu items   |
| >       | Next item on current menu level   |
| ↓       | Select a parameter setting  |



# Basic Weighing Function

## Features

- Tare the balance
- Printing weights

▷ If necessary, change the configuration settings:  
see the chapter entitled “Configuration”

## Preparation

- ▶ Switch on the balance:  
Press the  key
- ▶ Tare the balance, if necessary:  
Press the  key





▷ If desired, load the factory settings:  
see the chapter entitled “Configuration”

## Additional Functions:

- ▶ Switching off the balance:  
Press 

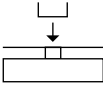
## Example

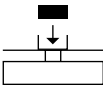
### Simple Weighing

| Step   | Press key   | Display   Printout |
|--|---|--------------------|
| 1. Switch on the balance<br>Self-test is performed,<br>followed by automatic<br>initial tare function. |    | 0.0 g              |
| 2. Place container on weighing pan<br>(in this example 11.5 g).  |   | + 11.5 g           |
| 3. Tare the balance  |  | 0.0 g              |
| 4. Place sample in container<br>(in this example: 132 g)   |  | + 132.0 g          |
| 5. Print weight  |  | N + 132.0 g        |

---

# Calibration and Adjustment

## Purpose

Calibration is the determination of any difference between the measured value displayed and the true weight (mass) of a sample. Adjustment is the correction of this difference, or its reduction to an allowable level within maximum permissible error limits.

## Features

Calibration | adjustment can be performed only when

- there is no load on the balance
- the balance is tared
- the internal signal is stable
- the weight displayed for the sample on the balance must not differ from the nominal weight by more than 2%.

If these conditions are not met, an error message is displayed "ERR 02".

Following calibration | adjustment, the application program is cleared.

## Internal Calibration | Adjustment

Note:

Only for models with the label **Entris...i-1S** !

In the operating menu, select *CAL.JUST.* - *CAL.INT.* before beginning. The built-in motorized calibration weight located in the housing is applied and removed automatically for internal calibration.

► Select calibration | adjustment:  
Press 

- > The internal calibration weight is applied automatically
- > The balance is adjusted | calibrated
- > The built-in calibration weight is removed

---

## Internal Calibration | Adjustment



Note:

Only for models with the label **Entris..i-1S** !

Set the following parameters:

SETUP - BAL.SCAL. - CAL.JUST. - CAL.INT. (Code 1.1.9.4)

The built-in motorized calibration weight located in the balance housing is applied and removed automatically for internal calibration.



| Step  | Key (or instruction)  | Display  |
|---|---|----------|
| 1. Tare the balance                             |  | 0.0 g    |
| 2. Start calibration                            |  | CAL.INT. |
|   | The internal calibration weight is applied automatically.                         | CAL.RUN. |
| 3. Adjustment carried out                       |   | CAL.END  |
| 4. The internal weight is defined automatically |   | 0.0 g    |

## External Calibration

Set the following parameters:

SETUP - BAL.SCAL. - CAL.WUST. - CAL.EXT. (Code 1.1.9. 1)

The required calibration weight is configured at the factory (see "Specifications").

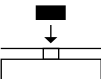
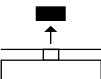





| Step   | Key (or instruction)  | Display                |
|--|---|------------------------|
| 1. Tare balance  |    | 0.0 g                  |
| 2. Start adjustment routine  |    | CAL.EXT.<br>- 5000.0 g |
| Once you store the zero point the display prompts for the required calibration weight (flashing display)   |   |                        |
| 3. Apply the prompted calibration weight (in this example 5000 g).<br>Weight too low:<br>a minus sign "-" is shown<br>Weight too high:<br>a plus sign "+" is shown |    | 5000.0 g               |
| The display stops flashing as soon as the weight value is within the defined limit.  |   |                        |
| 4. Calibration/adjustment executed; then the calibration weight is displayed   |   | CAL.END<br>+ 5000.0 g  |
| 5. Remove the calibration weight   |  | 0.0 g                  |

---

# Configuration (Operating Menu)











You can configure the balance; i.e., adapt it to individual requirements.

## Functions of the Keys during Configuration:

| Symbol        | Key  | Function   |
|---------------|--|--|
| V             |                   | Scroll through menu items  |
| >             |                   | One menu level lower<br>(use right cursor to scroll through up to 4 menu levels) |
| ↵             |                   | Confirm menu item  |
|               |  (Press and hold) | Save settings and exit menu<br>from any position                                 |
| <<            |                   | At the top level:<br>Save settings and exit menu:                                |
| <             |                   | One menu level higher (left cursor)  |
| <b>[••••]</b> |  | Indicates menu level   |

## Menu Navigation

Example: Setting the Language

| Step  | Key (or instruction)  | Display   |
|---|---|---|
| 1. <b>Open the menu:</b><br>Open the menu in weighing mode  |  hold  | APPLIC.   |
| 2. Scroll upward within the menu level;<br>After the last menu code,<br>the first code is displayed again | Repeatedly<br>   | INPUT<br>...<br>LANGUAG.  |
| 3. Select the next menu level<br>(scrolls to the right)   | Repeatedly<br>   | ENGLISH °   |
| 5. <b>Change setting:</b><br>Scroll until the desired setting<br>is shown                                 |    | GERMAN  |
| 6. <b>Confirm the menu code;</b><br>"o" indicates the active setting                                      |    | GERMAN °  |
| 7. Return to the next higher<br>menu level  |    | LANGUAG.  |
| ▷ Set other menu items as desired   |  ,  |   |
| 8. <b>Save settings</b><br>and exit menu<br><br>or  | Repeatedly:<br>  |  |
| ▷ Exit menu without<br>saving changes   |    |   |
| > Restart your application  |   | 0.0 g   |



## Parameter Settings (Overview)







| Level 1 [● ]                    | Level 2 [●● ]                        | Level 3 [●●● ]  | Menu code    |
|---------------------------------|--------------------------------------|---|--------------|
| SETUP                           | BAL.SCAL. Balance   scale parameters | AMBIENT conditions  | 1. 1. 1.     |
|                                 |                                      | APPFILT. Application filter   | 1. 1. 2.     |
|                                 |                                      | STAB.RNG. Stability range   | 1. 1. 3.     |
|                                 |                                      | TARING Taring 1)  | 1. 1. 5.     |
|                                 |                                      | AUTZER. Auto zero   | 1. 1. 6.     |
|                                 |                                      | WT.UNIT. Basic weight unit  | 1. 1. 7.     |
|                                 |                                      | DISP.ACC. Display accuracy  | 1. 1. 8.     |
|                                 |                                      | CAL.VADJ. Function of the  key | 1. 1. 9.     |
|                                 |                                      | CAL.UNIT. weight unit for calibration   | 1. 1.11.     |
|                                 | INTERF. Interface                    | BAUDrate  | 1. 5. 1.     |
|                                 |                                      | PARITY Parity   | 1. 5. 2.     |
|                                 |                                      | STOPBIT Number of stop bits   | 1. 5. 3.     |
|                                 |                                      | HANDSHK. Handshake mode   | 1. 5. 4.     |
|                                 |                                      | DATABIT Number of data bits   | 1. 5. 5.     |
|                                 |                                      | BAT.REC. Output: SBI (ASCII) or printout  | 1. 5. 6.     |
|                                 | PRNT.OUT Settings for print function | PRINT (manual   automatic)  | 1. 6. 1.     |
|                                 |                                      | STOPAUT. Stop automatic printing  | 1. 6. 2.     |
|                                 |                                      | AUT.CYCL. Time-dependent autom. printing  | 1. 6. 3.     |
|                                 |                                      | TAR.VPRT. Tare bal./balance after ind. print  | 1. 6. 4.     |
|                                 |                                      | PRT.INIT. Printout of appl. parameters  | 1. 6. 5.     |
| FORMAT Line format for printout |                                      | 1. 6. 6.  |              |
| EXTRAS (Additional functions)   | MENU Menu read only   can edit       | 1. 8. 1.  |              |
|                                 | SIGNAL Acoustic signal (beep)        | 1. 8. 2.  |              |
|                                 | KEYS (Keypad)                        | 1. 8. 3.  |              |
|                                 | EXT.KEY External switch function     | 1. 8. 4.  |              |
|                                 | ON.MODE Power-on mode                | 1. 8. 5.  |              |
|                                 | BACKLIT Display backlighting         | 1. 8. 6.  |              |
| RESET                           | MENU Factory settings                | 1. 9. 1.  |              |
| APPLIC.ation programs           | WEIGH                                |   | 2. 1.        |
|                                 | UNIT Toggle wt. unit                 | DISP.DIG. Display accuracy  | 2. 2. 2.     |
|                                 | COUNT.ing                            | RESOLUT. Resolution   | 2. 3. 1.     |
|                                 | PERCENT Weighing in percent          | REF.UPDT. Autom. ref. sample updating   | 2. 3. 2.     |
|                                 |                                      | DEC.PLCS Decimal places   | 2. 4. 1.     |
|                                 | ANIMAL Weighing                      | ACTIVITY. Animal activity   | 2. 7. 1.     |
|                                 |                                      | START   | 2. 7. 2.     |
|                                 | CALC.ulation                         | METHOD (Operator)   | 2. 8. 1.     |
| DEC.PLCS Decimal places         |                                      | 2. 8. 2.  |              |
| DENSITY determination           | DEC.PLCS Decimal places              | 2. 9. 1.  |              |
| INPUT Input                     | IDNO.                                | ID input; max. 7 characters, e.g. as Inventory no.  | 3. 1.        |
| INFORMATION                     | VERSION, SER.NO., MODEL              | Display software ver., serial no., model  | 4. 1. .2 .3. |
| LANGUAG. (LANGUAG.)             | ENGLISH (factory setting)            |   | 5. 1.        |
|                                 | DEUTSCH (German)                     |   | 5. 2.        |
|                                 | FRANçAIS (French)                    |   | 5. 3.        |
|                                 | ITALIANO (Italian)                   |   | 5. 4.        |
|                                 | ESPAÑOL (Spanish)                    |   | 5. 5.        |
|                                 | РУССКИЙ (Russian)                    |   | 5. 6.        |
|                                 | POLSKI (Polish)                      |   | 5. 7.        |
|                                 | CODES Menu shows codes (not texts)   |   | 5. 8.        |

## Parameter settings: Overview

o = Factory setting; ✓ = User-defined setting



| Level 1<br>[● ] | Level 2<br>[●● ]                | Level 3<br>[●●● ]                      | Level 4<br>[●●●● ]   | Menu code  |
|-----------------|---------------------------------|--|--|--|
| SETUP           | BAL.SCAL.<br>Balance parameters | AMBIENT conditions (Filter adaptation) | <ul style="list-style-type: none"> <li>o VERY STABLE</li> <li>o STABLE</li> <li>o UNSTABL</li> <li>o VERY UNSTABLE</li> </ul>  | <ul style="list-style-type: none"> <li>1. 1. 1. 1</li> <li>1. 1. 1. 2</li> <li>1. 1. 1. 3</li> <li>1. 1. 1. 4</li> </ul>   |
|                 |                                 | APP.FILT. Application filter           | <ul style="list-style-type: none"> <li>o FINALRD</li> <li>o FILLING</li> </ul>   | <ul style="list-style-type: none"> <li>1. 1. 2. 1</li> <li>1. 1. 2. 2</li> </ul>   |
|                 |                                 | STABILITY range                        | <ul style="list-style-type: none"> <li>1/4 DIG. (digit)</li> <li>1/2 DIG. (digit)</li> <li>1 - DIGIT (digit)</li> <li>o 2 - DIGIT (digit)</li> <li>4 - DIGIT (digit)</li> <li>8 - DIGIT (digit)</li> </ul> | <ul style="list-style-type: none"> <li>1. 1. 3. 1</li> <li>1. 1. 3. 2</li> <li>1. 1. 3. 3</li> <li>1. 1. 3. 4</li> <li>1. 1. 3. 5</li> <li>1. 1. 3. 6</li> </ul> |
|                 |                                 | TARING Taring                          | <ul style="list-style-type: none"> <li>o W/O STB (W/o stability)</li> <li>o W/ STB (After stability)</li> </ul>  | <ul style="list-style-type: none"> <li>1. 1. 5. 1</li> <li>1. 1. 5. 2</li> </ul>   |
|                 |                                 | AUT.ZERO Auto zero                     | <ul style="list-style-type: none"> <li>o OFF</li> <li>o ON</li> </ul>  | <ul style="list-style-type: none"> <li>1. 1. 6. 1</li> <li>1. 1. 6. 2</li> </ul>   |
|                 |                                 | WT.UNIT Basic weight through unit      | For list of units, see Chapter<br>"Toggling between weight units"  | <ul style="list-style-type: none"> <li>1. 1. 7. 1</li> <li>1. 1. 7.23</li> </ul>   |
|                 |                                 | DISP.DIG. Display accuracy             | <ul style="list-style-type: none"> <li>o ALL</li> <li>o MINUS 1</li> <li>o DIVIS. 11 interval</li> </ul>   | <ul style="list-style-type: none"> <li>1. 1. 8. 1</li> <li>1. 1. 8. 2</li> <li>1. 1. 8. 6</li> </ul>   |
|                 |                                 | CAL./ADJ. Function of the of the (Cal) | <ul style="list-style-type: none"> <li>o CAL.EXT. External cal./adj.</li> <li>o CAL.INT Internal cal./adj.</li> <li>o KEY BLOCKED (Cal) blocked</li> </ul>   | <ul style="list-style-type: none"> <li>1. 1. 9. 1</li> <li>1. 1. 9. 2</li> <li>1. 1. 3. 3</li> </ul>   |
|                 |                                 | CAL.UNIT Unit for calibration weight   | <ul style="list-style-type: none"> <li>o GRAMS</li> <li>o KILOGRAMS</li> <li>o POUNDS</li> </ul>   | <ul style="list-style-type: none"> <li>1. 1.11. 1</li> <li>1. 1.11. 2</li> <li>1. 1.11. 3</li> </ul>   |

| Level 1<br>[• ]   | Level 2<br>[•• ]                 | Level 3<br>[••• ]  | Level 4<br>[•••• ]    | Menu code  |
|---|----------------------------------|--|-----------------------|------------|
| SETUP   | INTERF.<br>Interface             | BAUDRate   | 600                   | 1. 5. 1. 3 |
|   |                                  |  | o 1200                | 1. 5. 1. 4 |
|   |                                  |  | 2400                  | 1. 5. 1. 5 |
|   |                                  |  | 4800                  | 1. 5. 1. 6 |
|   |                                  |  | 9600                  | 1. 5. 1. 7 |
|   |                                  | 19200  | 1. 5. 1. 8            |            |
|   |                                  | PARITY<br>Parity   | o 0DD                 | 1. 5. 2. 3 |
|   |                                  |  | EVEN                  | 1. 5. 2. 4 |
|   |                                  |  | NONE                  | 1. 5. 2. 5 |
|   |                                  | STOPBIT<br>No. of stop bits  | o 1STOP BIT           | 1. 5. 3. 1 |
|   |                                  |  | 2BITS                 | 1. 5. 3. 2 |
|   | HANDSHK.<br>Handshake<br>mode    | SFTWARE  | 1. 5. 4. 1            |            |
|   |                                  | o HARDWARE.  | 1. 5. 4. 2            |            |
|   |                                  | NONE   | 1. 5. 4. 3            |            |
|   | DATABIT<br>No. of data bits      | o 7BITS  | 1. 5. 5. 1            |            |
|   |                                  | 8BITS  | 1. 5. 5. 2            |            |
|   | DAT.REC. Com-<br>munication mode | 5BI (ASCII)  | 1. 5. 6. 1            |            |
|   |                                  | o PRINTER  | 1. 5. 6. 2            |            |
|   | PRNT.OUT<br>Printing fct.        | PRINT<br>(manual  <br>automatic)   | MAN.W/O stability     | 1. 6. 1. 1 |
|   |                                  |  | o MAN.WITH. stability | 1. 6. 1. 2 |
|   |                                  |  | AUT.W/O stability     | 1. 6. 1. 3 |
| AUT.WITH. stability   |                                  |  | 1. 6. 1. 4            |            |
| STOPAUT. Stop<br>automatic printing                           |                                  | o OFF Not possible   | 1. 6. 2. 1            |            |
|   |                                  | ON Use print key  | 1. 6. 2. 2            |            |
| AUT.CYCL.<br>Time-dependent<br>autom. printing                |                                  | o EACHVAL (1 display update)   | 1. 6. 3. 1            |            |
|   |                                  | AFTER 2 (2 display updates)  | 1. 6. 3. 2            |            |
| TAR./PRT.<br>Tare the balance<br>after individual<br>printout |                                  | o OFF  | 1. 6. 4. 1            |            |
|   |                                  | ON   | 1. 6. 4. 2            |            |

| Level 1<br>[• ]                    | Level 2<br>[•• ]                       | Level 3<br>[••• ]                                 | Level 4<br>[••••]   | Menu code         |            |
|------------------------------------|--|---|---|-------------------|------------|
| SETUP                              | PRNT.OUT<br>Printing fct.              | PRT.INIT.<br>Printing applica-<br>tion parameters | OFF   | 1. 6. 5. 1        |            |
|                                    |  |   | o ALL parameters  | 1. 6. 5. 2        |            |
|                                    |  |   |   | o MAINPAR.ameters | 1. 6. 5. 2 |
|                                    |  | FORMAT Line for-<br>mat for printout              | 16.CHAR.(digit not identified)  | 1. 6. 6. 1        |            |
|                                    |  |   | o 22.CHAR.acters (w/ ID)  | 1. 6. 6. 2        |            |
|                                    |  | EXTRAS<br>(Additional<br>functions)               | MENU  | CANE.DIT.Ie       | 1. 8. 1. 1 |
|                                    | R.D.ONLY read only                     |   |   | 1. 8. 1. 2        |            |
|                                    | SIGNAL<br>Acoustic signal              |   | OFF   | 1. 8. 2. 1        |            |
|                                    |  |   | o ON  | 1. 8. 2. 2        |            |
|                                    | KEYS<br>(keypad)                       |   | o FREE  | 1. 8. 3. 1        |            |
|                                    |  |   | LOCKED  | 1. 8. 3. 2        |            |
|                                    | EXT.KEY<br>External<br>switch function |   | o PRINT Key  | 1. 8. 4. 1        |            |
|                                    |  |   | Z.TARE Key   | 1. 8. 4. 2        |            |
|                                    |  |   | CALL Key     | 1. 8. 4. 3        |            |
|                                    |  |   | SELECT Key   | 1. 8. 4. 4        |            |
|                                    |  |   | CF Key       | 1. 8. 4. 5        |            |
|                                    |  |   | ENTER Key    | 1. 8. 4. 6        |            |
|                                    | ON-MODE<br>Power-on<br>mode            | o OFF/ON Off   on   stand-by                      | 1. 8. 5. 1  |                   |            |
|                                    |  | o STANDBY On   Stand-by                           | 1. 8. 5. 2  |                   |            |
|                                    |  | o AUTO-ON Automatic on mode                       | 1. 8. 5. 3  |                   |            |
| BACKLIT<br>Display<br>backlighting | OFF                                    | 1. 8. 6. 1  |   |                   |            |
|                                    | o ON                                   | 1. 8. 6. 2  |   |                   |            |
| RESET<br>Menu reset                | MENU<br>factory settings               | YES restore factory settings                      | 1. 9. 1. 1  |                   |            |
|                                    |  | o NO Do not restore<br>factory settings           | 1. 9. 1. 2  |                   |            |

| Level 1<br>[• ]              | Level 2<br>[•• ]                                | Level 3<br>[••• ]                        | Level 4<br>[•••• ]                     | Menu code                |
|------------------------------|---|--|--|--------------------------|
| APPL.<br>ication<br>programs | WEIGHING<br>toggling<br>between weight<br>UNITS | CONFIG.<br>display accuracy              | o ALL                                  | 2. 1.                    |
|                              |   |  | MINUS 1                                | 2. 2. 2. 1               |
|                              |   |  | DIV. 11 interval                       | 2. 2. 2. 2<br>2. 2. 2. 6 |
|                              | COUNTING  | RESOLUT.                                 | o DISP.DIG. Display accuracy           | 2. 3. 1. 1               |
|                              |   |  | 10FOLD 10 times > display              | 2. 3. 1. 2               |
|                              |   | REF.UPDT.<br>Auto Reference-<br>updating | o OFF                                  | 2. 3. 2. 1               |
|                              |   |  | AUTOM.atic                             | 2. 3. 2. 2               |
|                              | PERCENT<br>Weighing<br>in percent               | DEC.PLCS.<br>Decimal<br>places           | NONE no decimal places                 | 2. 4. 1. 1               |
|                              |   |  | o 1 DEC.PL. 1 decimal place            | 2. 4. 1. 2               |
|                              |   |  | 2 DEC.PL. 2 decimal places             | 2. 4. 1. 3               |
|                              |   |  | 3 DEC.PL. 3 decimal places             | 2. 4. 1. 4               |
|                              | ANIMALW.<br>Animal<br>weighing                  | ACTIVITY<br>Animal<br>activity           | CALM (fluct.: 2% of test obj.)         | 2. 7. 1. 1               |
|                              |   |  | o ACTIVE (fluct.: 5% of test obj.)     | 2. 7. 1. 2               |
|                              |   |  | V.ACTIVE (fluct.: 20% of<br>test obj.) | 2. 7. 1. 3               |
|                              |   | START                                    | MANUAL                                 | 2. 7. 2. 1               |
| o AUTOM.atic                 |   |  | 2. 7. 2. 2                             |                          |
| DENSITY<br>determination     | DEC.PLCS.<br>decimal places                     | NONE no decimal places                   | 2. 9. 1. 1                             |                          |
|                              |   | o 1 DEC.PL. 1 decimal place              | 2. 9. 1. 2                             |                          |
|                              |   | 2 DEC.PL. 2 decimal places               | 2. 9. 1. 3                             |                          |
|                              |   | 3 DEC.PL. 3 decimal places               | 2. 9. 1. 4                             |                          |

## Device-specific information

| Level 1<br>[• ]   | Level 2<br>[•• ] | Level 3<br>[••• ]  | Example       | Code  |
|-------------------|------------------|--|---------------|-------|
| INFO<br>rmination | VER. NO.         | Show software version  | REL.32.09     | 4. 1. |
|                   | SER. NR.         | Show serial number, e.g.:<br>(To toggle focus between<br>upper and lower display<br>sections: Press  )            | 297 12345     | 4. 2. |
|                   | MODEL            | Show model designation<br>(to change focus from upper<br>to middle to lower display<br>section and back: Press  ) | ENTRIS 124-15 | 4. 3. |

## Display of Menu Items: Selecting Languages or Codes

|                        |                                    |       |
|------------------------|------------------------------------|-------|
| LANGUAG.<br>(LANGUAG.) | ENGLISH (factory setting)          | 5. 1. |
|                        | DEUTSCH (German)                   | 5. 2. |
|                        | FRANÇ.çais (French)                | 5. 3. |
|                        | ITAL.iano (Italian)                | 5. 4. |
|                        | ESPAÑOL (Spanish)                  | 5. 5. |
|                        | РУССКИЙ (Russian)                  | 5. 6. |
|                        | POLSKI (Polish)                    | 5. 7. |
|                        | CODES Menu shows codes (not texts) | 5. 8. |

# Application Programs

## Counting

Display symbol: ☼

### Purpose

With the Counting application, you can determine the number of parts that each have approximately equal weight. To do this, a known number of parts (the reference sample quantity) is weighed first, and the individual piece weight (reference weight) is calculated from this result. Thus the number of parts subsequently placed on the balance can be determined from their weight.

### Changing the Reference Sample Quantity

Activate function:

Press the  key

Select the desired reference sample quantity (1 to 100):

In increments of 1: Press the  key briefly

In increments of 10:

Press and hold the  key.

The quantity is stored in battery-backed

memory.

### Reference Sample Updating

Automatic reference sample updating optimizes the counting accuracy. You can activate or deactivate this function in the menu.

Automatic reference sample updating is performed when the requirements, including the specified stability criterion, have been met.

The abbreviation *OPT* for “optimizing”, is displayed briefly with the new reference sample quantity.

### Preparation

- ▶ Select the Counting application in the menu:  
see “Configuration”
- ▶ Set the following parameters:

APPLIC.ation programs

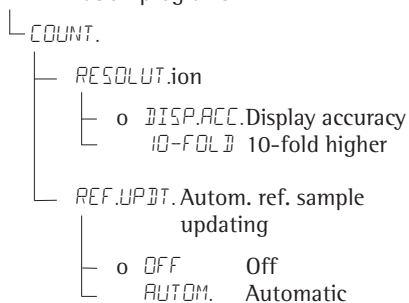









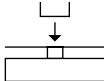

o = Factory setting

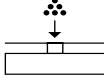
### Printout: Counting

|      |           |                                  |
|------|-----------|----------------------------------|
| nRef | 10        | : Ref. sample quantity           |
| wRef | 21.14 g   | : Reference weight<br>for 1 unit |
| Qnt  | + 500 pcs | : Calculated quantity            |

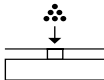
**Example:** Counting parts of equal weight

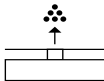
Parameter settings: *APPLIC. - COUNT.* (menu code 2. 3.)

| Step   | Key (or instruction)   | Display/Data output  |
|--|--|--|
| 1. Place empty container on the balance  |   | + 22.6 g   |
| 2. Tare the balance  |   | 0.0 g  |
| 3. Add reference sample quantity to container (in this example: 20 pcs)  |   |  |
| 4. Changing the reference sample quantity  |  |  REF 10 pcs |
| 5. Select reference sample quantity:<br>In increments of 1 (1, 2, 3, ..., 100)<br>In increments of 10 (10, 20, ..., 100)   | Repeatedly:<br>Press briefly<br>press and hold  | REF 20 pcs   |
| 6. Confirm selected reference sample quantity and start the application. The current reference weight remains saved until a new reference is set or the power supply is interrupted. |   | + 20 pcs *<br>nRef 20 pcs<br>wRef 1.07 g   |
| 7. Add desired number of pieces  |   | + 500 pcs  |
| 8. If desired, print quantity  |   | Qnt + 500 pcs  |
| 9. Toggle display between mean piece weight, weight, quantity  | Repeatedly:                                   | + 1.07 g Δ*<br>+ 535.0 g *<br>+ 500 pcs *  |
| 10. Unload the balance   |   | - 2 pcs *  |
| 11. Repeat as needed, starting from Step 7   |  |  |
| 12. End "Counting"   |   | 0.0 g  |



# Weighing in Percent

Display symbol: %

## Purpose

This application allows you to obtain weight readouts in percent which are in proportion to a reference weight.

## Changing the Reference Percentage

Activate function:

Press the  key

Select the desired reference (1 to 100):  
In increments of 1: Press the  key briefly

Increments of 10: Press and hold the  key.

The percentage is stored in battery-backed memory.

## Preparation

- ▶ Select the Weighing in percent application in the menu:  
see “Configuration”
- ▶ Set the following parameters:

APPLIcation programs

└ PERCENT Weighing in percent

└ DEC.PLCS Decimal places

└ NONE Decimal places

└ 0 1 DEC.PL. 1 decimal place

└ 2 DEC.PL. 2 decimal places









└ 3 DEC.PL. 3 decimal places

o = Factory setting

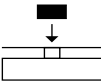
## Printout: Weighing in percent

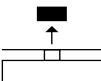
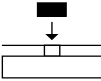
|      |          |                                       |
|------|----------|---------------------------------------|
| pRef | 100      | : Reference percentage                |
| Wx%  | 111.6 g  | : Reference weight for percentage xx% |
| Prc  | + 94.9 % | : Calculated reference percentage     |

**Example:** Determining residual weight in percent  
 Parameter settings: *APPLIC. - PERCENT* (menu code 2. 4.)  
 Reference percentage: *REF 100%*

| Step   | Key (or instruction)  | Display/Data output                         |
|--|---|---|
| 1. Tare the balance  |                | 0.0 g                                       |
| 2. Changing the reference:<br>(see the previous page)  |                | REF 100 %                                   |
| 3. Place sample equal to 100% on the balance<br>(in this example: 111.6 g)   |                |   |
| 4. Start the application.<br>The current reference weight remains stored until a new reference is set or power to the power supply is interrupted. |                | + 100.0 % *<br>pRef 100 %<br>Wxx% + 111.6 g |
| 5. Remove sample (e.g. for drying)   |                |   |
| 6. Place weight on the balance<br>(in this example 322.5 g)  |               | + 94.9 % *                                  |
| 7. If desired, print percentage  |              | Prc + 94.9 %                                |
| 8. Toggle display between weight and percentage  | Repeatedly:  | + 105.9 g *<br>+ 94.9 % *                   |
| 9. Clear display of residual weight and reference percentage<br>Exit application   |              | + 105.9 g                                   |
| 10. If desired, print net residual weight  |              | N + 105.9 g                                 |

# Animal Weighing/Averaging

Display symbol: 

## Purpose

This application is used to determine the weights of unstable samples (e.g., live animals) or to determine weights under very unstable ambient conditions. With this program, the balance calculates the weight as the average of a defined number of individual weighing operations (also referred to as “subweighing operations”).

## Changing the Number of Subweighing Operations

Activate function:

Press the  key

Select the desired number of measurements (1 to 100):

In increments of 1: Press the  key briefly

Increments of 10: Press and hold the  key.

The selected number of measurements is stored in battery-backed memory.

## Preparation

- ▶ Select the Animal weighing application in the menu:  
see “Configuration”
- ▶ Set the following parameters:

APPLIC.ation programs

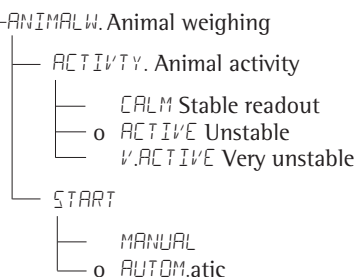







o = Factory setting

## Printout: Animal weighing

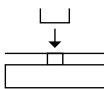
|         |         |                                    |
|---------|---------|------------------------------------|
| mDef    | 20      | : Number of subweighing operations |
| x-Net + | 410.1 g | : Calculated average               |

**Example:** Determining animal weight with automatic start and 20 subweighing operations (measurements)

Parameter settings: *APPLIC. - ANIMALW.* (menu code 2. 7.)

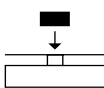
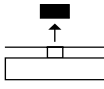
| Step   | Key (or instruction)   | Display/Data output                            |
|--|--|--|
| 1. Place animal weighing bowl on the balance   |   | 22.6 g   |
| 2. Tare the balance  |   | 0.0 g  |
| 3. Change the number of subweighing operations:  |   | REF 30   |
| 4. Select number of measurements:<br>In increments of 1 (1, 2, 3, ..., 100)<br>In increments of 10 (10, 20, ..., 100)  | Repeatedly:<br>Press briefly <br>press and hold  | REF 20   |
| 5. Confirm number of measurements and start automatic animal weighing.<br>The number of measurements remains stored in battery-backed memory until the setting is changed.         |   | + 0.0 g *                                      |
| 6. Place first animal in bowl.<br>The balance delays the start of measurements until the difference between 2 measurements meets the criterion.                                    |    | 888<br>19<br>20<br>...<br>1                    |
| 7. Read off the result.<br>The result is displayed with the "*" symbol (= calculated value) and remains displayed until the sample (animal) is removed from the load plate (bowl). |  | + 410.1 g Δ*<br><br>mDef 20<br>x-Net + 410.1 g |
| 8. Unload the balance  |   | + 0.0 g *                                      |
| 9. Weigh next animal (if des.)   |  |  |

Next weighing series begins automatically.

# Toggleing between Weight Units

## Purpose











With this application program you can change the weight value displayed from the basic weight unit to any of 4 application weight units (see table on next page).

## Features

- Set the basic unit and display accuracy in the Setup menu: see “Configuration”.
- Set the application weight units and display accuracies in the Application menu.
- These settings are stored in battery-backed memory.
- The basic unit is active when the balance is powered up.

**Example:** Change display from the basic unit (in this example, grams [g]) to pounds [lb] and Troy ounces [ozt].

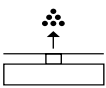
Set the following parameters: *APPLIC. - UNIT* (code 2. 2.)

| Step   | Press key   | Display   Printout           |
|--|---|------------------------------|
| <b>Preparation:</b>  |   |                              |
| 1. Begin selection of an application weight unit   |    | NONE ° [• ]                  |
| 2. Select an application unit, in this example “pounds” (see table on next page)   | Repeatedly:<br>  | POUNDS                       |
| 3. Confirm the weight unit (pounds)  |    | POUNDS °                     |
| 4. Select the next application weight unit, in this example: Troy ounces (see table on next page)  |  ,<br>Repeatedly:<br> | NONE ° [•• ]<br>TROY.OZ.     |
| 5. Confirm weight unit (Troy ounces)   |    | TROY.OZ. °                   |
| 6. Select other application units if desired (max. 4 total) (otherwise, confirm “NO” by pressing  ) |   | [••• ]                       |
| 7. Store selection   |    | 0.00 g                       |
| <b>Conversion:</b>   |   |                              |
| 8. Place sample on balance   |    | + 100.00 g                   |
| 9. Toggle unit for weight value  | Repeatedly:<br>  | + 0.22046 lb<br>+ 3.5275 ozt |

The following weight units are available in your balance :

| Menu item                  | Unit            | Conversion factor | Display symbol |
|----------------------------|-----------------|-------------------|----------------|
| 1) USERDEF. <sup>1)</sup>  | Grams           | 1.00000000000     | o              |
| 2) GRAMS (Factory setting) | Grams           | 1.00000000000     | g              |
| 3) KILOGR.                 | Kilograms       | 0.00100000000     | kg             |
| 4) CARATS                  | Carats          | 5,00000000000     | o              |
| 5) POUNDS                  | Pounds          | 0.00220462260     | lb             |
| 6) OUNCES                  | Ounces          | 0.03527396200     | oz             |
| 7) TROY.OZ.                | Troy ounces     | 0.03215074700     | ozt            |
| 8) HKTAEL                  | Hong Kong tael  | 0.02671725000     | tl             |
| 9) SING.TAEL.              | Singapore tael  | 0.02645544638     | tl             |
| 10) TWIN.TAEL.             | Taiwanese tael  | 0.02666666000     | tl             |
| 11) GRAINS                 | Grains          | 15.4323583500     | GN             |
| 12) PENNY.WT.              | Pennyweights    | 0.64301493100     | dwt            |
| 13) MILLIGR.               | Milligrams      | 1000.00000000     | mg             |
| 14) PT.P.LB.               | Parts per pound | 1.12876677120     | o              |
| 15) CHINA.TAEL             | Chinese tael    | 0.02645547175     | tl             |
| 16) MOMMES                 | Mommes          | 0.26670000000     | m              |
| 17) AUST.CT.               | Austrian carats | 5.00000000000     | Kt             |
| 18) TOLA                   | Tola            | 0.08573333810     | o              |
| 19) BAHT                   | Baht            | 0.06578947436     | b              |
| 20) MESGHAL                | Mesghal         | 0.21700000000     | o              |
| 21) TONS                   | Tons            | 0.00000100000     | t              |
| 22) LB / OZ <sup>2)</sup>  | Pounds : ounces | 0.03527396200     | lb oz          |
| 23) NEWTON                 | Newton          | 0.00980665000     | N              |

<sup>1)</sup> = User-defined weight unit; can be loaded in the balance over an optional RS-232 or USB interface using a computer program.

<sup>2)</sup> = The format for display of pounds: ounces is xx:yy.yyy; x=lb, y=oz

# Density Determination

Display symbol:  $\rho$

## Purpose

This application program lets you determine the density of solid substances using the buoyancy method.

## Features

To enter the density of the buoyancy liquid( $\text{g}/\text{cm}^3$ ) at the corresponding temperature, press . See the next page for a table of density values for water. The factory setting is  $1 \text{ g}/\text{cm}^3$ .

The following formula is applied:

Density of sample =

$$\frac{\text{Weight in air}}{(\text{Weight in air} - \text{weight in water})} + \text{density of liquid}$$

When you start the density determination routine, the density of the liquid is displayed briefly.

Positive and negative values can be stored for weight in air and weight in water.

The weight in water must be less than the weight in air; otherwise, an error message is displayed.

The results can be displayed with 0 to 3 decimal places: see "Configuration". Not part of the scope of delivery: sample holder and suspension wire.

## Preparation

- ▶ Select the Density Determination application in the menu: see "Configuration"
- ▶ Set the following parameters:

APPLIC. ation programs

DENSITY determination

DEC.PLCS Decimal places

- NONE No decimal places
- o 1 DEC.PL. 1 decimal place
- 2 DEC.PL. 2 decimal places
- 3 DEC.PL. 3 decimal places

o = Factory setting

Note on using 3 decimal places: Using three decimal places for density can result in a high measurement error rate because corrections to the air density and the density calculation sets are not taken into account, for example.

### Printout for Density Determination

|       |         |      |  |
|-------|---------|------|--|
| RhoFl | 0.99823 | o    | : Density of liquid (g/cm <sup>3</sup> ) |
| Wa    | +       | 20.0 | g : Weight in air                        |
| Wfl   | +       | 15.0 | g : Weight in liquid                     |
| Rho   |         | 4.0  | o : Result: density of the sample        |

**Table:**  
**Density of H<sub>2</sub>O at Temperature T (in °C)**













| T/°C | 0.0     | 0.1     | 0.2     | 0.3     | 0.4     | 0.5     | 0.6     | 0.7     | 0.8     | 0.9     |
|------|---------|---------|---------|---------|---------|---------|---------|---------|---------|---------|
| 10.  | 0.99973 | 0.99972 | 0.99971 | 0.99970 | 0.99969 | 0.99968 | 0.99967 | 0.99966 | 0.99965 | 0.99964 |
| 11.  | 0.99963 | 0.99962 | 0.99961 | 0.99960 | 0.99959 | 0.99958 | 0.99957 | 0.99956 | 0.99955 | 0.99954 |
| 12.  | 0.99953 | 0.99951 | 0.99950 | 0.99949 | 0.99948 | 0.99947 | 0.99946 | 0.99944 | 0.99943 | 0.99942 |
| 13.  | 0.99941 | 0.99939 | 0.99938 | 0.99937 | 0.99935 | 0.99934 | 0.99933 | 0.99931 | 0.99930 | 0.99929 |
| 14.  | 0.99927 | 0.99926 | 0.99924 | 0.99923 | 0.99922 | 0.99920 | 0.99919 | 0.99917 | 0.99916 | 0.99914 |
| 15.  | 0.99913 | 0.99911 | 0.99910 | 0.99908 | 0.99907 | 0.99905 | 0.99904 | 0.99902 | 0.99900 | 0.99899 |
| 16.  | 0.99897 | 0.99896 | 0.99894 | 0.99892 | 0.99891 | 0.99889 | 0.99887 | 0.99885 | 0.99884 | 0.99882 |
| 17.  | 0.99880 | 0.99879 | 0.99877 | 0.99875 | 0.99873 | 0.99871 | 0.99870 | 0.99868 | 0.99866 | 0.99864 |
| 18.  | 0.99862 | 0.99860 | 0.99859 | 0.99857 | 0.99855 | 0.99853 | 0.99851 | 0.99849 | 0.99847 | 0.99845 |
| 19.  | 0.99843 | 0.99841 | 0.99839 | 0.99837 | 0.99835 | 0.99833 | 0.99831 | 0.99829 | 0.99827 | 0.99825 |
| 20.  | 0.99823 | 0.99821 | 0.99819 | 0.99817 | 0.99815 | 0.99813 | 0.99811 | 0.99808 | 0.99806 | 0.99804 |
| 21.  | 0.99802 | 0.99800 | 0.99798 | 0.99795 | 0.99793 | 0.99791 | 0.99789 | 0.99786 | 0.99784 | 0.99782 |
| 22.  | 0.99780 | 0.99777 | 0.99775 | 0.99773 | 0.99771 | 0.99768 | 0.99766 | 0.99764 | 0.99761 | 0.99759 |
| 23.  | 0.99756 | 0.99754 | 0.99752 | 0.99749 | 0.99747 | 0.99744 | 0.99742 | 0.99740 | 0.99737 | 0.99735 |
| 24.  | 0.99732 | 0.99730 | 0.99727 | 0.99725 | 0.99722 | 0.99720 | 0.99717 | 0.99715 | 0.99712 | 0.99710 |
| 25.  | 0.99707 | 0.99704 | 0.99702 | 0.99699 | 0.99697 | 0.99694 | 0.99691 | 0.99689 | 0.99686 | 0.99684 |
| 26.  | 0.99681 | 0.99678 | 0.99676 | 0.99673 | 0.99670 | 0.99668 | 0.99665 | 0.99662 | 0.99659 | 0.99657 |
| 27.  | 0.99654 | 0.99651 | 0.99648 | 0.99646 | 0.99643 | 0.99640 | 0.99637 | 0.99634 | 0.99632 | 0.99629 |
| 28.  | 0.99626 | 0.99623 | 0.99620 | 0.99617 | 0.99614 | 0.99612 | 0.99609 | 0.99606 | 0.99603 | 0.99600 |
| 29.  | 0.99597 | 0.99594 | 0.99591 | 0.99588 | 0.99585 | 0.99582 | 0.99579 | 0.99576 | 0.99573 | 0.99570 |
| 30.  | 0.99567 | 0.99564 | 0.99561 | 0.99558 | 0.99555 | 0.99552 | 0.99549 | 0.99546 | 0.99543 | 0.99540 |

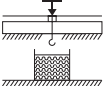

Parameter settings:

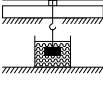
APPLIC. - DENSITY - DEC.PLCS. - 1 DEC.PL. (menu code 2. 9. 1. 2)

**Example:** Determining the density of a solid using water as the buoyancy liquid.  
 The density of water at 20°C is 0.99823 g/cm<sup>3</sup>.

| Step  | Key (or instruction)  | Display/Data output   |
|---|---|-----------------------|
| 1. Attach sample holder and suspension wire   |   |                       |
| 2. Tare the balance   |    | 0.0 g                 |
| 3. Edit the stored density value  |    | - 1.00000             |
| 4. Enter the density of the liquid<br>(in this example: 0.99823); Enter numerals in increments of 1                             | Repeatedly:  ,<br>briefly or press and hold ;  , etc. | - 0.99823             |
| 5. Save density value and start application. The density value is stored in battery-backed memory until the setting is changed. |    |                       |
| 6. Confirm "AIR" display  |    | AIR ?                 |
| 7. Determine the weight of sample in the air:<br>Place sample on the balance  |    | + 20.0 g ?*           |
| 8. Store value for weight in air  |    |                       |
| 9. Remove sample from the balance   |   | WATER ?               |
| 10. Determine weight in liquid:<br>Place sample in holder.  |    |                       |
| 11. Confirm "WATER" display   |    | 0.0 g ?*              |
| 12. Immerse sample in liquid  |   | + 15.0 g ?*           |
| 13. Store value for weight in liquid, view and print result   |    | + 4.0 <sup>o</sup> ?* |
|   |   | RhoFL 0.6237 o        |
|   |   | Wa + 20.0 g           |
|   |   | WfL + 15.0 g          |
| 14. Delete result   |    | Rho 4.0 o             |
| 15. Repeat as needed, starting from Step 5.   |   |                       |

# Data Interface

## Purpose

Your balance comes equipped with an interface port for connection to a computer or other peripheral device. You can use an on-line computer to change, start and/or monitor the functions of the balance and the application programs.

## Female interface connector

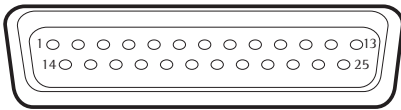

Pin Assignment Chart, 25-pin, RS-232:

- Pin 1: Shield
- Pin 2: Data output (TxD)
- Pin 3: Data input (Rx/D)
- Pin 4: Internal ground (GND)
- Pin 5: Clear to Send (CTS)
- Pin 6: Not connected
- Pin 7: Internal ground (GND)
- Pin 8: Internal ground (GND)
- Pin 9: Not connected
- Pin 10: Not assigned
- Pin 11: + 12 V (operating voltage for Sartorius printer)
- Pin 12: Reset \_ Out
- Pin 13: + 5 V
- Pin 14: Internal ground (GND)
- Pin 15: Universal remote switch
- Pin 16: Not connected
- Pin 17: Not connected
- Pin 18: Not connected
- Pin 19: Not connected
- Pin 20: Data Terminal Ready (DTR)
- Pin 21: Not connected
- Pin 22: Not connected
- Pin 23: Not connected
- Pin 24: Not connected
- Pin 25: + 5 V

## Preparation

You can set these parameters for other devices in the Setup menu: see "Configuration".

You will also find a detailed description

of the available data interface commands in the file "Data Interface Descriptions for Entris Models", which you can download from the Sartorius website:

([www.sartorius.com](http://www.sartorius.com)  
"Download Center".)

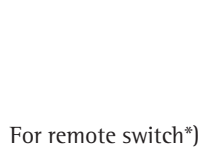





\*) = Hardware restart

---

# Troubleshooting Guide

Error codes are shown on the main display for approx. 2 seconds.  
The program then returns automatically to the previous mode.

| Display                               | Cause  | Solution  |
|---------------------------------------|--|---|
| No segments appear on the display     | No AC power is available<br>The power supply is not plugged in   | Check the AC power supply<br>Plug in the power supply   |
| <i>HIGH</i>                           | The load exceeds the balance capacity  | Unload the balance  |
| <i>LOW</i> or <i>ERR 54</i>           | Something is touching the weighing pan   | Move the object that is touching the weighing pan   |
| <i>APP.ERR.</i>                       | Cannot store data:<br>Load on weighing pan too light or no sample on pan while application is active   | Increase load   |
| <i>BIS.ERR.</i>                       | Display error:<br>Data output not compatible with output format  | Change the configuration in the operating menu  |
| <i>PRT.ERR.</i>                       | Interface port for printer output is blocked   | Reset the menu factory settings or<br>Contact your local Sartorius Service Center   |
| <i>ERR 02</i>                         | Calibration parameter not met, e.g.:<br>– Press  to tare the balance<br>– load on weighing pan      | Calibrate only when zero is displayed<br><br>Unload the balance   |
| <i>ERR 10</i>                         | The  key is blocked for active application programs;<br>Only 1 tare function can be used at a time | After the tare memory has been deleted using the  key, the  key can be used again |
| <i>ERR 11</i>                         | Tara memory not allowed  | Press    |
| The weight readout changes constantly | Unstable ambient conditions (excessive vibration or draft)<br>A foreign object is caught between weighing pan and housing  | Set up balance in another area<br>Adjust Setup configuration<br>Remove the foreign object   |
| The weight readout is obviously wrong | The balance was not calibrated/adjusted<br>Balance not tared before weighing   | Calibrated/adjust the balance   |

If any other errors occur, contact your local Sartorius Service Center.

Web address: <http://www.sartorius.com>

---

# Care and Maintenance

## Service

On request, Sartorius can offer you an individual service contract.

## Repairs

Repair work must only be carried out by trained service technicians. Repairs performed by untrained persons may result in considerable hazards for the user.

## Cleaning



Unplug the AC adapter from the wall outlet (mains supply). If you have an interface cable connected to the balance port, unplug it from the port.  
Make sure that no liquid enters the balance housing.

---

- ▶ Clean the balance with a cloth lightly moistened with soap solution.
  - ▷ The plastic top and bottom parts of the balance housing have a special coating that allows acetone to be used to clean these parts.
- 



Do not clean the following parts with acetone or aggressive cleaning agents: foil-covered keypad, power connector port, data interface, or any other plastic parts.

---

- ▶ Wipe the balance with a soft, dry cloth.

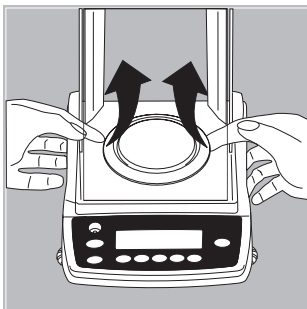

On analytical balances remove and clean the weighing pan as follows:



Reach beneath the shield disk and lift it up carefully together with the weighing pan to avoid damaging the weighing system.  
Make sure that no liquid enters the balance housing.

---

### Cleaning Stainless Steel Surfaces

Clean all stainless steel parts regularly. Remove the stainless steel weighing pan and thoroughly clean it separately. Use a damp cloth or sponge to clean stainless steel parts on the balance.

You can use any household cleaning agent that is suitable for use on stainless steel. Clean stainless steel surfaces only by wiping them down. Then rinse the equipment thoroughly, making sure to remove all residues. Afterwards, allow the equipment to dry. If desired, you can apply oil to the cleaned surfaces as additional protection.

# Recycling

## Safety Inspections

If there is any indication that safe operation of the balance is no longer warranted:

- ▶ Disconnect the equipment from the AC power: Unplug the power cord.
- > Lock the balance in a secure place to ensure that it cannot be used for the time being

Inform Sartorius Service Center. Maintenance and repair work may only be carried out by trained service technicians.

We recommend that the device be inspected by a certified electrician at regular intervals, according to the following checklist:

- Insulating resistance > 7 megaohms measured with a constant voltage of at least 500 V at a 500 kohm load
- Leakage current: < 0.05 mA measured with a properly calibrated multimeter

## Recycling

The packaging is made of environmentally friendly materials that can be used as secondary raw materials. If you no longer need this packaging, bring it to your local recycling and waste disposal facility according to the regulations applicable in your country .

(Contract number D-59101-2009-1129).

Otherwise you should dispose of the material in accordance with the waste disposal regulations that are applicable in your area.



The equipment, including accessories and batteries, does not belong in your regular household waste. The EU legislation requires its Member States to collect electrical and

electronic equipment and disposed of it separately from other unsorted municipal waste with the aim of recycling it.

For more information regarding disposal and recycling, please contact our local service representatives. Our partners listed on the following website will also be able to provide assistance within the EU:

- 1) Go to <http://www.sartorius.com>.
- 2) Select the "Services" tab.
- 3) Then select "Disposal Information".
- 4) Addresses for the local Sartorius disposal contacts can be found in the PDF files available for download on this page.



Sartorius will not take back equipment contaminated with hazardous materials (ABC contamination) – either for repair or disposal.

## Service address disposal:

Please refer to our website ([www.sartorius.com](http://www.sartorius.com)) or contact the Sartorius Service Center for more detailed information regarding repair service addresses or the disposal of your device.

---

# Overview

## Specifications

### General Specifications

|  |    |  |
|--|----|--|
| <b>Int. weight circuit</b>   |    | <b>All models with the designation Entris ... i-1S are equipped with an internal calibration weight.</b> |
| Mains connection, voltage, frequency   |    | via Desktop power supply 697 199, 100 – 240 Vac, $\pm 10\%$ , 50–60 Hz; 200 mA (max.)                    |
| Power consumption  | VA | maximum 16; average 8 (including power supply)   |
| Operating time with external battery YRB11Z (display backlighting on), approx. h |    | 35   |

### Ambient conditions

The Technical Data are valid for the following ambient conditions:

|   |                                    |
|---|------------------------------------|
| Operating temperature range               | +10 ... +30 °C (+50 °F ... +86 °F) |
| Permissible ambient operating temperature | +5 ... +40 °C                      |

Functionality is guaranteed up to an ambient temperature +5 °C to 40 °C.

---

|  |           |
|--|-----------|
| Electromagnetic Compatibility (EMC)                          | EN61326-1 |
| Interference emission  | Class B   |
| Defined immunity to interference for industrial environments |           |

---

### Model-specific Specifications

| <b>Model: Entris</b>  |      | <b>224-1S</b>  | <b>124-1S</b>        | <b>64-1S</b>         |
|---|------|--|----------------------|----------------------|
|   |      | <b>224i-1S</b>   | <b>124i-1S</b>       | <b>64i-1S</b>        |
| Weighing capacity   |      | 220 g  | 120 g                | 60 g                 |
| Readability   |      | 0.0001 g   | 0.0001 g             | 0.0001 g             |
| Tare range (subtractive)                                    |      | 220 g  | 120 g                | 60 g                 |
| Repeatability (standard deviation)                          | < ±  | 0.0001 g   | 0.0001 g             | 0.0001 g             |
| Linearity   | <±   | 0.0002 g   | 0.0002 g             | 0.0002 g             |
| Response time (average)                                     | s    | 2,5  | 2,5                  | 2,5                  |
| Sensitivity drift within +10 ... +30 °C                     | <±/K | 2 · 10 <sup>-6</sup>   | 2 · 10 <sup>-6</sup> | 2 · 10 <sup>-6</sup> |
| Adaptation to ambient conditions                            |      | By selection of 1 of 4 optimized filter levels; display update: 0.1–0.4 (depends on filter level selected) |                      |                      |
| External calibration weight (of at least accuracy class...) | g    | 200 (E2)   | 100 (E2)             | 50 (E2)              |
| Net weight, approx.   | kg   | 4.4   4.8  | 4.4   4.8            | 4.4   4.8            |
| Weighing pan size   | mm   | 90 Ø   | 90 Ø                 | 90 Ø                 |
| Whg. chamber height   | mm   | 230  | 230                  | 230                  |
| Dimensions (W × D × H)                                      | mm   | 230 × 303 × 330  |                      |                      |

| <b>Model: Entris</b>  |      | <b>623-1S</b>   | <b>423-1S</b>        | <b>323-1S</b>        |
|---|------|---|----------------------|----------------------|
|   |      | <b>623i-1S</b>  | <b>423i-1S</b>       | <b>323i-1S</b>       |
| Weighing capacity   |      | 620 g   | 420 g                | 320 g                |
| Readability   |      | 0.001 g   | 0.001 g              | 0.001 g              |
| Tare range (subtractive)                                    |      | 620 g   | 420 g                | 320 g                |
| Repeatability (standard deviation)                          | < ±  | 0.001 g   | 0.001 g              | 0.001 g              |
| Linearity   | <±   | 0.002 g   | 0.002 g              | 0.002 g              |
| Response time (average)                                     | s    | 1   | 1                    | 1.1                  |
| Sensitivity drift within +10 ... +30 °C                     | <±/K | 2 · 10 <sup>-6</sup>  | 2 · 10 <sup>-6</sup> | 2 · 10 <sup>-6</sup> |
| Adaptation to ambient conditions                            |      | By selection of 1 of 4 optimized filter levels; display update: 0.1 – 0.4 (depending on the set filter level) |                      |                      |
| External calibration weight (of at least accuracy class...) | g    | 500 (F1)  | 200 (F1)             | 200 (F1)             |
| Net weight, approx.   | kg   | 3.2 3.6   | 3.2 3.6              | 3.2 3.6              |
| Weighing pan size   | mm   | 115 Ø   | 115 Ø                | 115 Ø                |
| Dimensions (W × D × H)                                      | mm   | 230 × 303 × 136   |                      |                      |

| <b>Model: Entris</b>   |      | <b>153-1S<br/>153i-1S</b>   | <b>822-1S<br/>822i-1S</b> |
|--|------|---|---------------------------|
| Weighing capacity  |      | 150 g   | 820 g                     |
| Readability  |      | 0.01 g  | 0.001 g                   |
| Tare range (subtractive)                                       |      | 150 g   | 320 g                     |
| Repeatability<br>(standard deviation)                          | < ±  | 0.01 g  | 0.001 g                   |
| Linearity  | <±   | 0.03 g  | 0.002 g                   |
| Response time (average)  | s    | 1.3   | 1.3                       |
| Sensitivity drift within<br>+10 ... +30 °C                     | <±/K | 4 · 10 <sup>-6</sup>  | 5 · 10 <sup>-6</sup>      |
| Adaptation to ambient conditions                               |      | By selection of 1 of 4 optimized filter levels;<br>display update: 0.1–0.4 (depends on filter level selected) |                           |
| External calibration weight<br>(of at least accuracy class...) | g    | 100 (F1)  | 500 (F2)                  |
| Net weight, approx.  | kg   | 2.6 3.0   | 2.0 2.6                   |
| Weighing pan size  | mm   | 150 Ø   | 150 Ø                     |
| Deviations (W×D×H)   | mm   | 230×303×91  | 230×303×87                |

| <b>Model: Entris</b>   |      | <b>6202-1S<br/>6202i-1S</b>   | <b>4202-1S<br/>4202i-1S</b> | <b>3202-1S<br/>3202i-1S</b> | <b>2202-1S<br/>2202i-1S</b> |
|--|------|---|-----------------------------|-----------------------------|-----------------------------|
| Weighing capacity  |      | 6200 g  | 4200 g                      | 3200 g                      | 2200 g                      |
| Readability  |      | 0.01 g  | 0.01 g                      | 0.01 g                      | 0.01 g                      |
| Tare range (subtractive)                                       |      | 6200 g  | 4200 g                      | 3200 g                      | 2200 g                      |
| Repeatability<br>(standard deviation)                          | < ±  | 0.01 g  | 0.01 g                      | 0.01 g                      | 0.01 g                      |
| Linearity  | <±   | 0.03 g  | 0.03 g                      | 0.03 g                      | 0.03 g                      |
| Response time (average)  | s    | 1.5   | 1.5                         | 1.5                         | 1.5                         |
| Sensitivity drift within<br>+10 ... +30 °C                     | <±/K | 2 · 10 <sup>-6</sup>  | 2 · 10 <sup>-6</sup>        | 2 · 10 <sup>-6</sup>        | 2 · 10 <sup>-6</sup>        |
| Adaptation to ambient conditions                               |      | By selection of 1 of 4 optimized filter levels;<br>display update: 0.1–0.4 (depends on filter level selected) |                             |                             |                             |
| External calibration weight<br>(of at least accuracy class...) | g    | 5000 (F1)   | 2000 (F1)                   | 2000 (F1)                   | 2000 (F1)                   |
| Net weight, approx.  | kg   | 3.1 3.5   | 3.1 3.5                     | 3.1 3.5                     | 3.1 3.5                     |
| Weighing pan size  | mm   | 180×180   | 180×180                     | 180×180                     | 180×180                     |
| Dimensions (W×D×H)   | mm   | 230×303×91  |                             |                             |                             |



| <b>Modele: Entris</b>  |      | <b>8201-1S</b><br><b>8201i-1S</b>   | <b>5201-1S</b><br><b>5201i-1S</b> | <b>2201-1S</b><br><b>2201i-1S</b> |
|--|------|---|-----------------------------------|-----------------------------------|
| Weighing capacity  |      | 8200 g  | 5200 g                            | 2200 g                            |
| Readability  |      | 0.1 g   | 0.1 g                             | 0.1 g                             |
| Tare range (subtractive)                                       |      | 8200 g  | 5200 g                            | 2200 g                            |
| Repeatability<br>(standard deviation)                          | < ±  | 0.1 g   | 0.1 g                             | 0.1 g                             |
| Linearity  | <±   | 0.1 g   | 0.1 g                             | 0.1 g                             |
| Response time (average)  | s    | 1.5   | 1.5                               | 1.5                               |
| Sensitivity drift within<br>+10 ... +30 °C                     | <±/K | 10 · 10 <sup>-6</sup>   | 10 · 10 <sup>-6</sup>             | 10 · 10 <sup>-6</sup>             |
| Adaptation to ambient conditions                               |      | By selection of 1 of 4 optimized filter levels;<br>display update: 0.1–0.4 (depends on filter level selected) |                                   |                                   |
| External calibration weight<br>(of at least accuracy class...) | g    | 5000 (F2)   | 5000 (F2)                         | 2000 (F2)                         |
| Net weight, approx.  | kg   | 2,7 3,5   | 2,7 3,5                           | 2,7 3,5                           |
| Weighing pan size  | mm   | 180 × 180   | 180 × 180                         | 180 × 180                         |
| Dimensions (W × D × H)   | mm   | 230 × 303 × 91  |                                   |                                   |

# Accessories

## External calibration weights:

| For Entris balance models | Accuracy class | Weight in grams | Order no.:   |
|---------------------------|----------------|-----------------|--------------|
| 224                       | E2             | 200             | YCW522-AC-02 |
| 124                       | E2             | 100             | YCW512-AC-02 |
| 64                        | E2             | 50              | YCW512-AC-02 |
| 423                       | F1             | 200             | YCW523-AC-02 |
| 323                       | F1             | 200             | YCW523-AC-02 |
| 153                       | F1             | 100             | YCW513-AC-02 |
| 623                       | F1             | 500             | YCW553-AC-02 |
| 4202                      | F1             | 2000            | YCW623-AC-02 |
| 6202                      | F1             | 5000            | YCW653-AC-02 |
| 3202                      | F1             | 2000            | YCW623-AC-02 |
| 2202                      | F1             | 2000            | YCW623-AC-02 |
| 822                       | F2             | 500             | YCW554-AC-02 |
| 8201                      | F2             | 5000            | YCW654-AC-02 |
| 5201                      | F2             | 5000            | YCW654-AC-02 |
| 2201                      | F2             | 2000            | YCW624-AC-02 |

| Product   | Order No.        | Product  | Order No.  |
|---|------------------|--|--|
| <b>Data printer</b><br>with date, time, statistics<br>evaluation, transaction counter<br>functions and LCD display  | <b>YDP20-OCE</b> | <b>Density determination kit</b><br>– for Entris 224<br>– for Entris 124<br>– for Entris 64                                      | <b>YDK01LP</b>   |
| <b>Remote display,</b><br>reflective<br>(for connection to<br>data interface port)  | <b>YRD03Z</b>    | <b>Data cable</b><br>– for connection to a<br>PC mit USB port<br>– for PC connection,<br>25-pin<br>– for PC connection,<br>9-pin | <b>YCC01-USBM2</b><br><br><b>7357312</b><br><br><b>7357314</b> |
| <b>External rechargeable<br/>           battery pack</b><br>With battery-level indicator (LED);<br>can be recharged using the AC<br>adapter (charge time for completely<br>discharged battery pack: 15 hours);<br>see “Specifications” for hours of<br>operation.<br>To recharge the battery pack:<br>Unplug the AC adapter from the balance<br>and plug it into the battery pack | <b>YRB11Z</b>    | <b>Adapter cable</b><br>from D-Sub 25-pin<br>male connector to<br>D-Sub 9-contact<br>female connector;<br>length: 0.25 m         | <b>6965619</b>   |

| <b>Product</b>  | <b>Order No.</b> |
|---|------------------|
| <b>Ionizing blower</b> for eliminating static electricity   |                  |
| - 220 V   | <b>YIB01-ODR</b> |
| - 110 V   | <b>YIB01-OUR</b> |
| <b>Stat-Pen antistatic device</b> for eliminating electrostatic charges on samples and containers (100 V bis 230 V, 50/60 Hz) | <b>YSTP01</b>    |
| <b>Weighing Table</b>   |                  |
| - made from wood with synthetic stone   | <b>YWT09</b>     |
| - weighing table made from synthetic stone, with vibration dampening  | <b>YWT03</b>     |
| <b>Wall console</b>   | <b>YWT04</b>     |
| <b>Weighing pans</b>  |                  |
| - 1000 ml, EG 240 g, stainless steel  | <b>641211</b>    |
| - 500 ml  | <b>641212</b>    |
| - 110 ml, 90 mm Ø, aluminum   | <b>69GP0003</b>  |
| - 270 ml, EG 62 g, 137 mm Ø, stainless steel  | <b>YWP03G</b>    |
| - 62 mm Ø, stainless steel  | <b>6910848</b>   |
| - 85 ml, 70 mm Ø, aluminum  | <b>YWP06G</b>    |
| - 180 ml, 90 mm Ø, aluminum   | <b>YWP05G</b>    |
| - 174 mm d, stainless steel   | <b>YWP04G</b>    |

# CE EG-/EU-Konformitätserklärung EC / EU Declaration of Conformity

**Hersteller** Sartorius Lab Instruments GmbH & Co. KG  
*Manufacturer* Weender Landstrasse 94 – 108, D-37075 Goettingen, Germany

erklärt in alleiniger Verantwortung, dass das Betriebsmittel  
*declares under own responsibility that the equipment*

**Geräteart** Elektronische Laborwaage  
*Device type* Electronically laboratory balance

**Baureihe** Entris.....-15  
*Type series*

in der von uns in Verkehr gebrachten Ausführung mit den grundlegenden Anforderungen der folgenden Europäischen Richtlinien übereinstimmt und die anwendbaren Anforderungen folgender harmonisierter Europäischer Normen erfüllt:  
*in the form as delivered complies with the essential requirements of the following European Directives and meets the applicable requirements of the harmonized European Standards listed below:*

2004/108/EG  
2004/108/EC **Elektromagnetische Verträglichkeit**  
*Electromagnetic compatibility*  
EN 61326-1:2006  
Elektrische Mess-, Steuer-, Regel- und Laborgeräte – EMV- Anforderungen – Teil 1: Allgemeine Anforderungen  
*Electrical equipment for measurement, control and laboratory use – EMC requirements – Part 1: General requirements*

2006/95/EG  
2006/95/EC **Elektrische Betriebsmittel zur Verwendung innerhalb bestimmter Spannungsgrenzen**  
*Electrical equipment designed for use within certain voltage limits*  
EN 61010-1:2010  
Sicherheitsbestimmungen für elektrische Mess-, Steuer-, Regel- und Laborgeräte – Teil 1: Allgemeine Anforderungen  
*Safety requirements for electrical equipment for measurement, control, and laboratory use – Part 1: General requirements*

2011/65/EU  
2011/65/EU **Beschränkung der Verwendung bestimmter gefährlicher Stoffe in Elektro- und Elektronikgeräten (RoHS)**  
*Restriction of the use of certain hazardous substances in electrical and electronic equipment (RoHS)*  
EN 50581:2012  
Technische Dokumentation zur Beurteilung von Elektro- und Elektronikgeräten hinsichtlich der Beschränkung gefährlicher Stoffe  
*Technical documentation for the assessment of electrical and electronic products with respect to the restriction of hazardous substances*

Jahreszahl der CE-Kennzeichenvergabe | *Year of the CE mark assignment:* 13

Sartorius Lab Instruments GmbH & Co. KG  
Goettingen, 2013-12-12

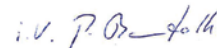

Dr. Reinhard Baumfalk  
Vice President R&D



Dr. Dieter Klausgrete  
Head of International Certification Management

Diese Erklärung bescheinigt die Übereinstimmung mit den genannten EG- und EU-Richtlinien, ist jedoch keine Zusicherung von Eigenschaften. Bei einer mit uns nicht abgestimmten Änderung des Produktes verliert diese Erklärung ihre Gültigkeit. Die Sicherheitshinweise der zugehörigen Produktdokumentation sind zu beachten.

*This declaration certifies conformity with the above mentioned EC and EU Directives, but does not guarantee product attributes. Unauthorised product modifications make this declaration invalid. The safety information in the associated product documentation must be observed.*



Sartorius Lab Instruments GmbH & Co. KG  
Weender Landstrasse 94–108  
37075 Goettingen, Germany  
Telephone 0551.308.0  
Fax 0551.308-3289

[www.sartorius.com](http://www.sartorius.com)

Copyright by Sartorius, Goettingen,  
Germany.

No part of this publication may be reprinted  
or translated in any form or by any means  
without prior written from Sartorius.

All rights reserved by Sartorius AG in  
accordance with copyright law.

The information and figures contained in  
these instructions correspond to the version  
date specified below. Sartorius reserves the  
right to make changes to the technology,  
features, specifications, and design of the  
equipment without notice.

Date:  
December 2013,  
Sartorius Lab Instruments GmbH & Co. KG