



**WEIGHING AND DIMENSIONING  
SOLUTIONS FOR LOGISTICS**

**CATALOGUE**

 **DINI ARCEO**  
Scales - Weighing systems

A RICE LAKE WEIGHING SYSTEMS COMPANY





---

A RICE LAKE WEIGHING SYSTEMS COMPANY



## WEIGHING AND DIMENSIONING SOLUTIONS FOR LOGISTICS

Mobile Weighing Systems Manufacturer



Dini Argeo - Head Quarter & Production Line - Fiorano Modenese, Italy

*Dini Argeo is an Italian company specializing in the design and production of scales and weighing systems, which stand out for quality, reliability and versatility of use, gaining increasing success on markets all over the world.*

**"For over 20 years Dini Argeo has been designing and manufacturing weighing solutions that stand out for their quality and reliability in the world of industry and logistics."**

In this catalogue you can find the different solutions for weighing, lifting and handling in industrial environments, even harsh ones, and inside the warehouse: pallet truck scales, pallet scales and weighing solutions to transform your forklift and electric pallet truck into a real mobile scale. Discover also our dimensioning systems that combine weight and volume data and are ideal for monitoring the flow of goods in and out of the warehouse.

The wide range of weighing solutions with customisable features makes Dini Argeo products easy to integrate into your warehouse and logistic lines. Thanks to its team of highly qualified engineers, Dini Argeo is also able to develop fully customised, certified weighing solutions and firmware in compliance with international standards.

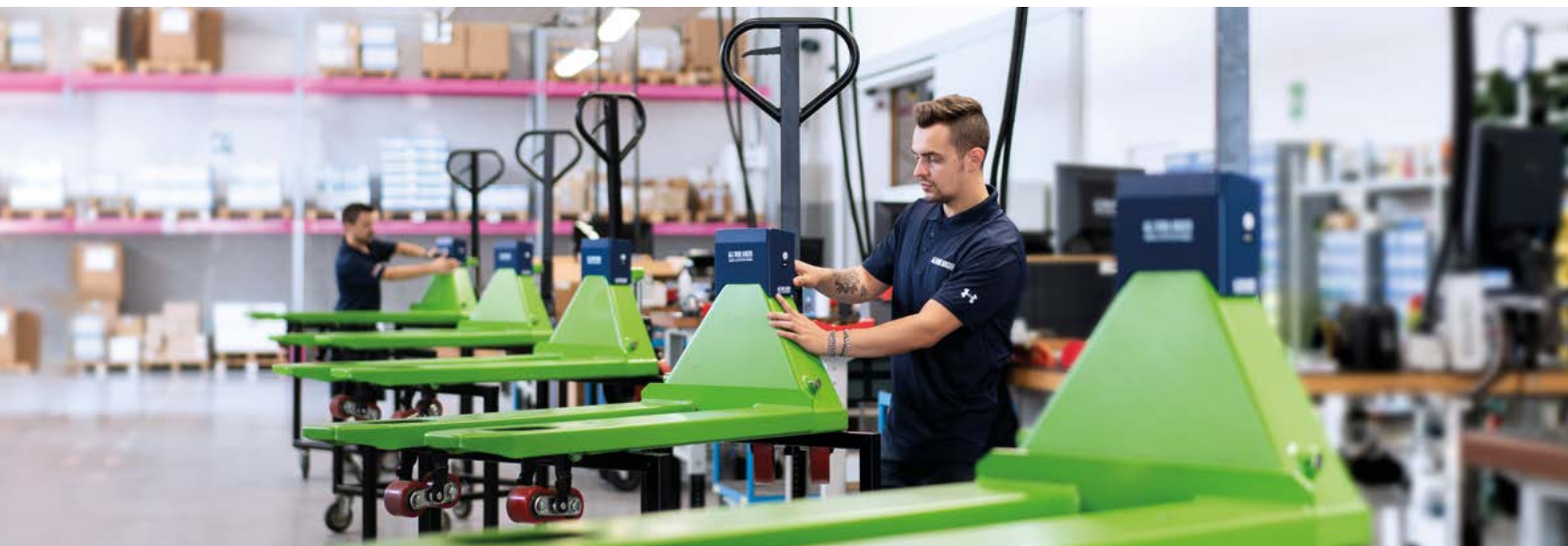

**PEDRIELLI**  
MODENA

PORTATA 6.3 t.



# INDEX

## PALLET TRUCK SCALES

p. 6

Dini Argeo pallet truck scales are manufactured in Italy, calibrated and tested in Dini Argeo facilities in Fiorano Modenese and delivered with a test certificate attesting the declared accuracy. Equipped with sturdy and resistant construction, in stainless steel or ATEX environments, they are the ideal solution for weighing and handling outside and inside the warehouse.

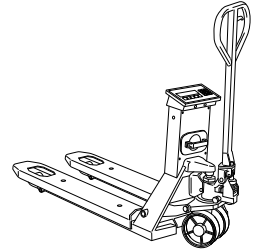

## PALLET SCALES

p. 42

Dini Argeo pallet scales are the ideal solution to create mobile weighing stations in your warehouse. Thanks to the display with column connected to the platform, reading the weight and controlling the movements made will be simple and fast.

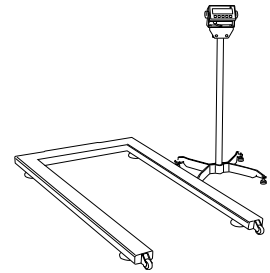

## WEIGHING KITS FOR FORKLIFTS AND ELECTRIC PALLET TRUCKS

p. 52

Dini Argeo boasts a range of weighing systems designed specifically for forklifts and electric pallet trucks: from pressure sensors, to weighing forks and plates to turn your forklift and electric pallet truck into a mobile scale.

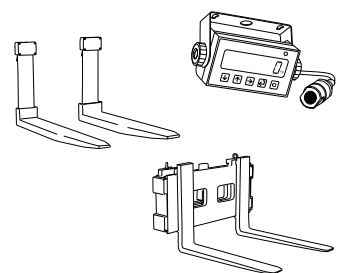

## DIMENSIONING SYSTEMS

p. 70

The Rice Lake Weighing Systems brand dimensioning systems combine the concept of weight and volume in order to determine the total size of packages and control the flow of incoming and outgoing goods.

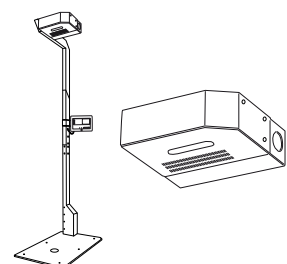

## HAND PALLET TRUCK SCALES

“

High-quality pallet truck scales, sturdy and accurate, specifically designed to meet all weighing needs in terms of handling and logistic requirements.

”



# HAND PALLET TRUCK SCALES

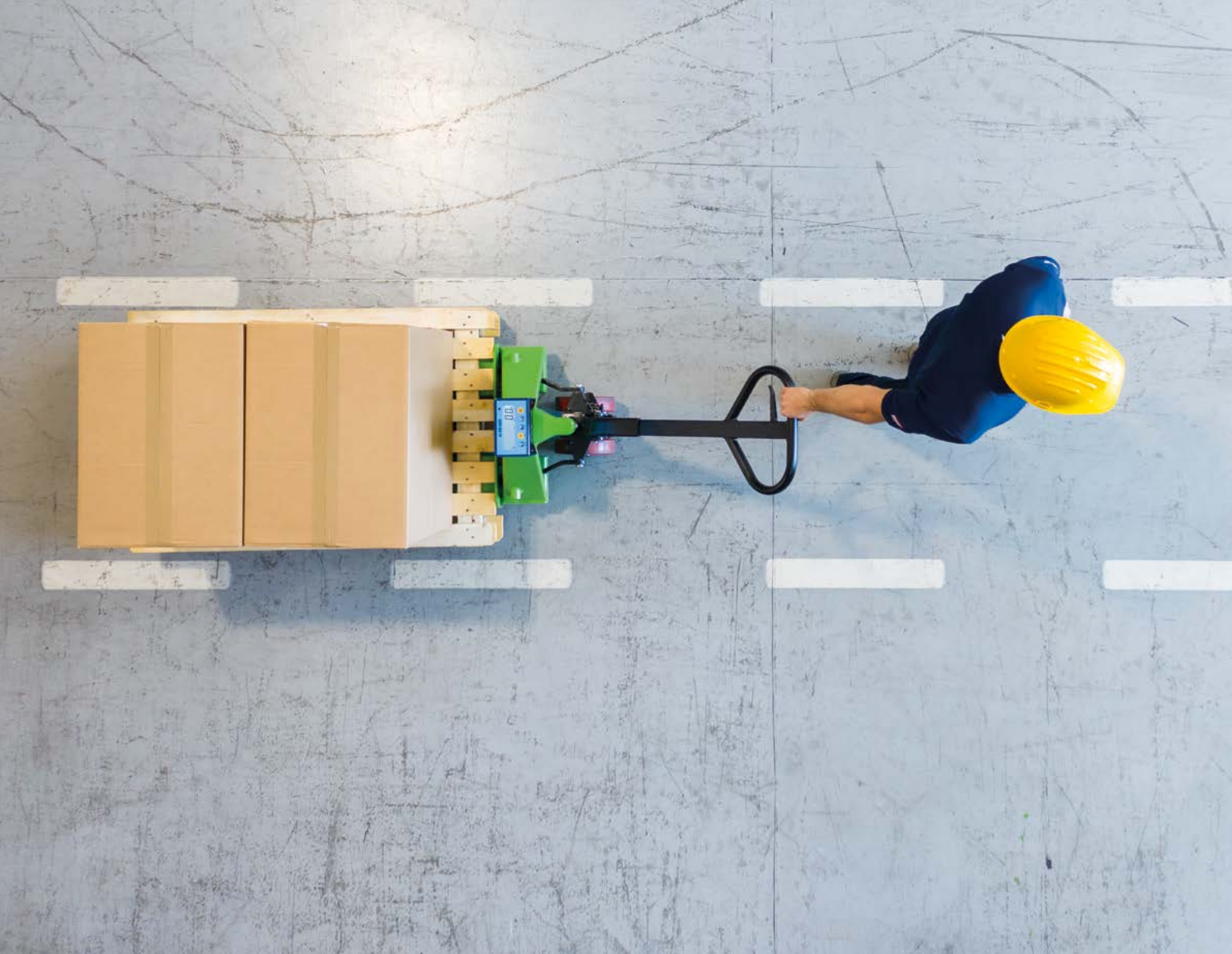

# TPWN

## MULTIFUNCTION

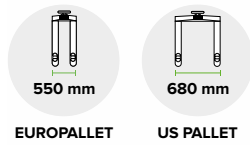
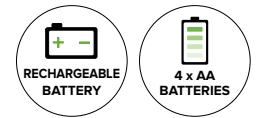

The only pallet truck scale with high precision and quality features made in Italy.

Choose it because:

- The best price-quality ratio
- It is the lightest on the market
- Packaged one by one in a sturdy, stackable, 100% recyclable protective packaging

### Main Functions

- **WEIGHT TOTALISATION**
- **PIECE COUNTING**
- **UNIT CONVERTER:** kg/lb, free conversion factor
- **ZEROING**
- **TARE**
- **PRESET TARE**

### Version codes

		Forks	Power supply	Max. Capacity (kg)	d (kg)	Product Code
			AA Batteries	1.000 - 2.000	0,5 - 1	<b>TTPWN-EASY</b>
			Rechargeable Battery	2.000	0,2	<b>TPWNBT-x</b>
			Rechargeable Battery	2.000	1	<b>TPWNBTW-x</b>

### Main Options

#### SPECIAL CALIBRATIONS

	Max. Capacity (kg)	d (kg)	Option Code
	2.500**	0,2	<b>FS2500</b>
<i>Special Capacities / Resolutions: upon request.</i>			-

(\*\*) Accuracy between 2.000 / 2.500 kg is 2 kg. Only for TPWNBT-x and TPWNBTW-x.

#### SPECIAL SIZES

<i>Other Special Sizes upon request.</i>	-
--	---

>> Discover the full range of options and accessories from page 36



Packaging and Weight (see page 84)

Legal for trade

Integrated Printer and Date & Time

(PRODUCT CODE-x): For the current code version please refer to [www.dinargeo.com](http://www.dinargeo.com)

## Main Features

Display	Shockproof 25 mm LCD backlit display
Display protection cover	As standard
Brightness	Adjustable brightness
IP protection rating	IP40 / IP54 with keyboard protection cover
Accuracy* (Internal use)	± 1 kg
Keyboard	5-key waterproof
Structure	Oven-fire painted steel
Steering wheels	Double polyurethane rollers
Load wheels	Double polyurethane loading rollers
Lift pump	Quick-lifting hydraulic pump
Load cells	Alloy steel, IP67 protection
Auto switch-off	Programmable
Power supply	Integrated rechargeable battery or 4 AA batteries
Operating time	About 80 h / About 40 h (with Duracell® AA batteries)
Battery recharge	Via a 230 Vac 50 Hz charger (8 h for full recharge) with EU power plug**
Operating temperature range	-10 / +40 °C
Communication to external devices	-

(\*) Weighing of goods on EUROPALLET with distributed load.

(\*\*) UK, AU, US versions: upon request.

## Certifications

- 2006/42/EU (Machine Directive)
- 2014/30/EU (EMC)
- 2014/35/EU (LVD)
- 2011/65/EU (RoHS)
- 2014/31/EU (NAWI)

## Technical Drawing (mm)

EUROPALLET / EPAL (550 mm)

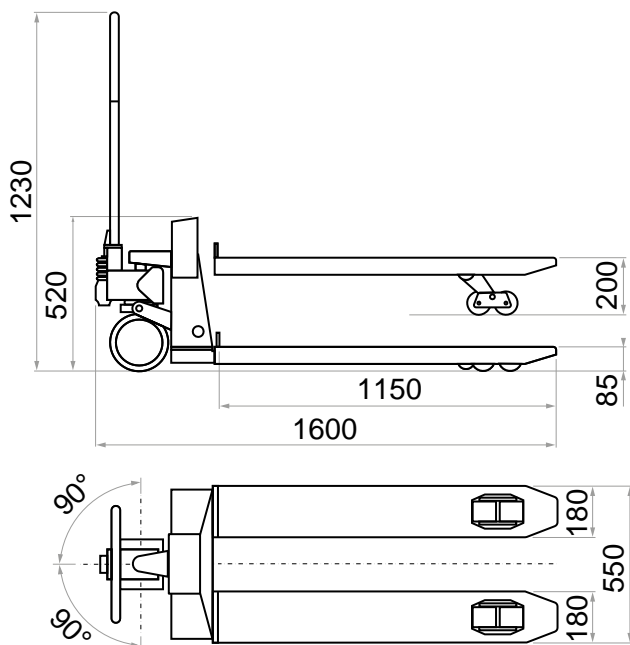

US PALLET (680 mm)

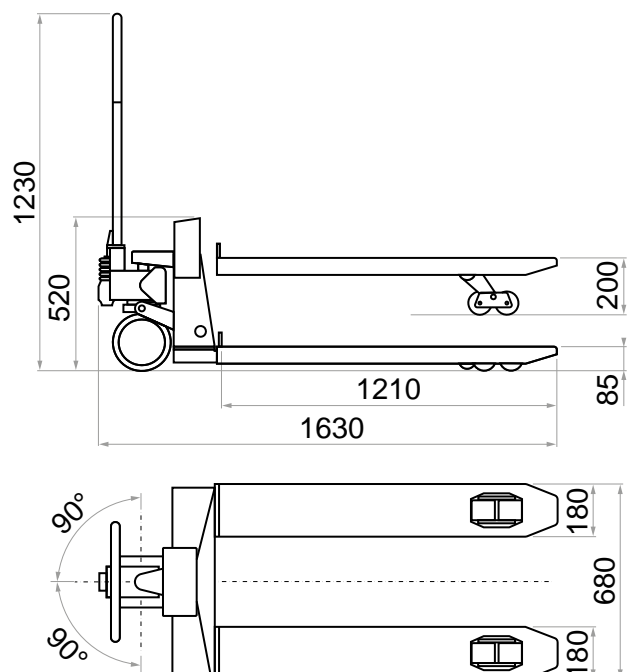

# TPWLK

LEGAL FOR TRADE WITH PRINTER

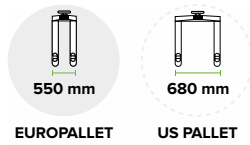
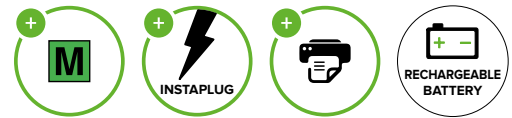

Professional pallet truck scale, with optional printer ideal for tracking weighing. Certified accuracy thanks to the legal-for-trade approval.

Choose it because:

- Approved for legal-for-trade use
- Also available with integrated printer
- Instaplug technology that allows for 24/7 use

## Main Functions

- **WEIGHT TOTALISATION**
- **PIECE COUNTING**
- **UNIT CONVERTER:** kg/lb, free conversion factor
- **50 TARE MEMORY**
- **PRINT NUMERIC IDs**
- **ZEROING**
- **TARE**
- **PRESET TARE**

## Version codes

M	Printer	Max. Capacity (kg)	d (kg)	e (kg)	Product Code
		2.000	0,2		TPWLK-x
M		1.000 - 2.000		0,5 - 1	TPWLKM-x
	Printer	2.000	0,2		TPWLKP-x
M	Printer	1.000 - 2.000		0,5 - 1	TPWLKPM-x

## Main Options

### SPECIAL CALIBRATIONS

M	Max. Capacity (kg)	d (kg)	e (kg)	Option Code
M	600		0,2	FS600M
M	600 - 1.500		0,2 - 0,5	FS1500M2R
M	1.500		0,5	FS1500M
M	1.500 - 2.500		0,5 - 1	FS2500M
	2.500**	0,2		FS2500
<i>Special Capacities / Resolutions: upon request.</i>				

(\*\*) Accuracy between 2.000 / 2.500 kg is 2 kg.

### SPECIAL SIZES

Forks for US pallet (680 mm).	TPWWF-x
<i>Other Special Sizes upon request.</i>	-

>> Discover the full range of options and accessories from page 36



Packaging and Weight (see page 84)

M Legal for trade

Printer Integrated Printer and Date & Time

(PRODUCT CODE-x): For the current code version please refer to [www.dinargeo.com](http://www.dinargeo.com)

## Main Features

Display	25 mm LCD backlit display	
Brightness	Adjustable brightness	
IP protection rating	IP65 / IP20 for models with printer	
Accuracy*	Internal use	± 1 kg
	Legal for trade 	In accordance with Directive 2014/31/EU
Keyboard	17-key waterproof	
Structure	Oven-fire painted steel	
Steering wheels	Double polyurethane rollers	
Load wheels	Double polyurethane loading rollers	
Lift pump	Quick-lifting hydraulic pump	
Load cells	4, in stainless steel, with IP68 protection	
Auto switch-off	5 min, programmable	
Power supply	"Instaplug" removable rechargeable battery	
Operating time	About 80 h	
Battery recharge	Via a 230 Vac 50 Hz charger (8 h for full recharge) with EU power plug**	
Operating temperature range	-10 / +40 °C	
Communication to external devices	Optional radio-frequency, Wi-Fi or Bluetooth	

(\*) Weighing of goods on EUROPALLET with distributed load.

(\*\*) UK, AU, US versions: upon request.

## Certifications

- 2006/42/EU (Machine Directive)
- 2014/30/EU (EMC)
- 2014/35/EU (LVD)
- 2011/65/EU (RoHS)
- 2014/31/EU (NAWI)

## Technical Drawing (mm)

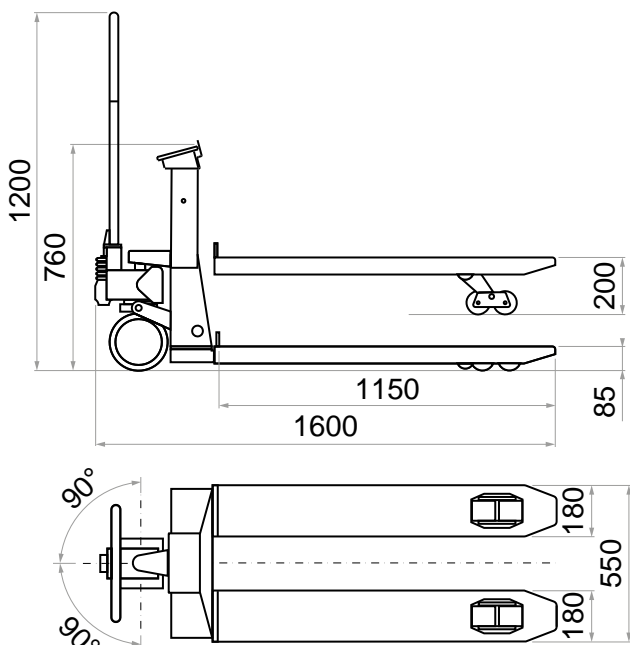

# TPWP

## HIGH RESOLUTION

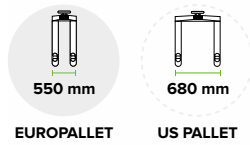

MANUFACTURED IN ITALY



Professional pallet truck scale ideal to reach the highest weighing resolution.

Choose it because:

- High resolution up to 100 g
- Swivelling head for the best reading comfort during manual dosing
- Instaplug technology that allows for 24/7 use

### Main Functions

- WEIGHT TOTALISATION
- PIECE COUNTING
- UNIT CONVERTER: kg/lb, free conversion factor
- 50 TARE MEMORY
- PRINT NUMERIC IDs
- ZEROING
- TARE
- PRESET TARE

### Version codes

M	Printer	Max. Capacity (kg)	d (kg)	e (kg)	Product Code
		2.000	0,2		TPWP-x
M		1.000 - 2.000		0,5 - 1	TPWPM-x

### Main Options

#### SPECIAL CALIBRATIONS

M	Max. Capacity (kg)	d (kg)	e (kg)	Option Code
M	600		0,2	FS600M
M	600 - 1.500		0,2 - 0,5	FS1500M2R
M	1.500		0,5	FS1500M
M	1.500 - 2.500		0,5 - 1	FS2500M
	2.000*	0,1		TPWHRES
	2.500**	0,2		FS2500
	Special Capacities / Resolutions: upon request.			-

(\*) Accuracy is the same as the standard version.

(\*\*) Accuracy between 2.000 / 2.500 kg is 2 kg.

#### SPECIAL SIZES

Forks for US pallet (680 mm).	TPWWF-x
Other Special Sizes upon request.	-

>> Discover the full range of options and accessories from page 36



Packaging and Weight (see page 84)

M Legal for trade

Printer Integrated Printer and Date & Time

(PRODUCT CODE-x): For the current code version please refer to [www.diniargeo.com](http://www.diniargeo.com)



The information in this document may be subject to change without notice.

## Main Features

Swivelling column head	As standard, $\pm 160^\circ$ rotation	
Display	25 mm LCD backlit display	
Brightness	Adjustable brightness	
IP protection rating	IP65 / IP20 for models with printer	
Accuracy*	Internal use	$\pm 0,5$ kg
	Legal for trade 	In accordance with Directive 2014/31/EU
Keyboard	17-key waterproof	
Structure	Oven-fire painted steel	
Steering wheels	Double polyurethane rollers	
Load wheels	Double polyurethane loading rollers	
Lift pump	Quick-lifting hydraulic pump	
Load cells	4, in stainless steel, with IP68 protection	
Auto switch-off	5 min, programmable	
Power supply	"Instaplug" removable rechargeable battery	
Operating time	About 60 h	
Battery recharge	Via a 230 Vac 50 Hz charger (8 h for full recharge) with EU power plug**	
Operating temperature range	-10 / +40 °C	
Communication to external devices	Optional radio-frequency, Wi-Fi or Bluetooth	

(\*) Weighing of goods on EUROPALLET with distributed load.

(\*\*) UK, AU, US versions: upon request.

## Certifications

- 2006/42/EU (Machine Directive)
- 2014/30/EU (EMC)
- 2014/35/EU (LVD)
- 2011/65/EU (RoHS)
- 2014/31/EU (NAWI)

## Technical Drawing (mm)

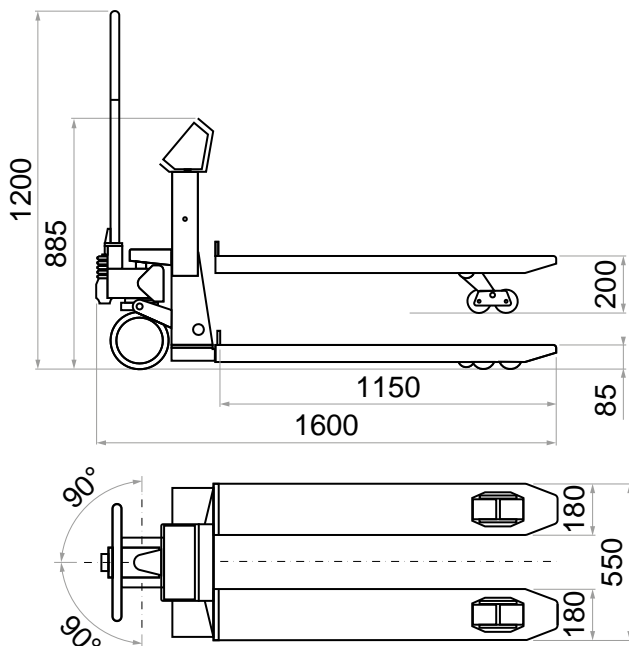

# TPW TOUCH

## TOUCH SCREEN

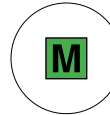

550 mm  
EUROPALLET

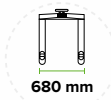

680 mm  
US PALLET



Professional pallet truck scale specific for advanced data management and communication with the main computer systems.

Choose it because:

- Fitted with touch screen indicator as standard
- Database management and data processing
- Can be integrated with Wi-Fi, barcode reader and Bluetooth

### Main Functions

- **DATABASE MANAGEMENT:** Products, Customers, Suppliers and Tares
- **FULL PROGRAMMABILITY**
- **15 PROGRAMMABLE TEXTS**
- **DATA TRANSFER**
- **FISCAL MEMORY**
- **APPLICATION PROGRAM FOR:** Totalisation, Piece Counting, Dosage
- **NUMERIC IDs**
- **TARE**
- **PRESET TARE**
- **ZEROING**

### Version codes

		Max. Capacity (kg)	d (kg)	e (kg)	Product Code
		2.000	0,2		TPWTS-x
		1.000 - 2.000		0,5 - 1	TPWTSM-x

### Main Options

#### SPECIAL CALIBRATIONS

	Max. Capacity (kg)	d (kg)	e (kg)	Option Code
	600		0,2	FS600M
	600 - 1.500		0,2 - 0,5	FS1500M2R
	1.500		0,5	FS1500M
	1.500 - 2.500		0,5 - 1	FS2500M
	2.000*	0,1		TPWHRES
	2.500**	0,2		FS2500
	Special Capacities / Resolutions: upon request.			-

(\*) Accuracy is the same as the standard version.

(\*\*) Accuracy between 2.000 / 2.500 kg is 2 kg.

#### SPECIAL SIZES

Forks for US pallet (680 mm).	TPWWF-x
Other Special Sizes upon request.	-

>> Discover the full range of options and accessories from page 36



Packaging and Weight (see page 84)

Legal for trade

Integrated Printer and Date & Time

(PRODUCT CODE-x): For the current code version please refer to [www.dinargeo.com](http://www.dinargeo.com)



## Main Features

Swivelling column head	As standard, $\pm 160^\circ$ rotation	
Display	5,7" touch screen backlit color display. Resistive technology	
IP protection rating	IP65 / IP20 for models with printer	
Accuracy*	Internal use	$\pm 0,5$ kg
	Legal for trade 	In accordance with Directive 2014/31/EU
Keyboard	Touch screen	
Structure	Oven-fire painted steel	
Steering wheels	Double polyurethane rollers	
Load wheels	Double polyurethane loading rollers	
Lift pump	Quick-lifting hydraulic pump	
Load cells	4, in stainless steel, with IP68 protection	
Auto switch-off	5 min, programmable	
Power supply	"Instaplug" removable rechargeable battery	
Operating time	About 10 h	
Battery recharge	Via a 230 Vac 50 Hz charger (8 h for full recharge) with EU power plug**	
Operating temperature range	-10 / +40 °C	
Communication to external devices	Optional radio-frequency, Wi-Fi or Bluetooth	
Fiscal memory (Alibi memory)	As standard	
Date / Time	As standard	
Database	1.000 articles, 300 tares, 200 customers / suppliers	
Programmability	Free memory spaces for customised application program	
Free alphanumeric texts	15	

(\*) Weighing of goods on EUROPALLET with distributed load.

(\*\*) UK, AU, US versions: upon request.

## Certifications

- 2006/42/EU (Machine Directive)
- 2014/30/EU (EMC)
- 2014/35/EU (LVD)
- 2011/65/EU (RoHS)
- 2014/31/EU (NAWI)

## Technical Drawing (mm)

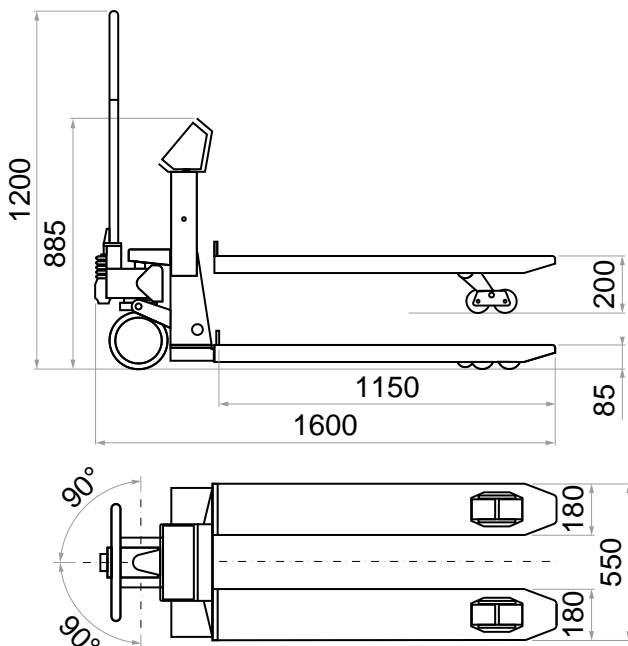

# TPW EX 3GD

3GD ATEX

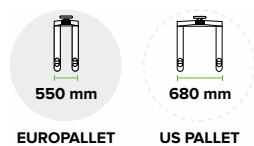

550 mm

EUROPALLET

680 mm

US PALLET



 MANUFACTURED IN ITALY

Pallet truck scale for ATEX hazardous areas (zones 2 and 22).

Choose it because:

- Made with ATEX-certified components
- High resolution up to 100 g
- Wireless communication to safe zone

## Main Functions





- **WEIGHT TOTALISATION**
- **PIECE COUNTING**
- **UNIT CONVERTER:** kg/lb, free conversion factor
- **50 TARE MEMORY**
- **ZEROING**
- **TARE**
- **PRESET TARE**

## Version codes

		Max. Capacity (kg)	d (kg)	e (kg)	Product Code
		2.000	0,2		TPWX3GD-x
		1.000 - 2.000		0,5 - 1	TPWX3GDM-x

## Main Options

### SPECIAL CALIBRATIONS

	Max. Capacity (kg)	d (kg)	e (kg)	Option Code
	600		0,2	FS600M
	600 - 1.500		0,2 - 0,5	FS1500M2R
	1.500		0,5	FS1500M
	1.500 - 2.500		0,5 - 1	FS2500M
	2.000*	0,1		TPWHRES
	2.500**	0,2		FS2500
	Special Capacities / Resolutions: upon request.			-

(\*) Accuracy is the same as the standard version.

(\*\*) Accuracy between 2.000 / 2.500 kg is 2 kg.

### SPECIAL SIZES

Forks for US pallet (680 mm).	TPWWFEX-x
Other Special Sizes upon request.	-
Stainless Steel Forks.	TPWXFI

>> Discover the full range of options and accessories from page 36



Packaging and Weight (see page 84)

 Legal for trade

 Integrated Printer and Date & Time

(PRODUCT CODE-x): For the current code version please refer to [www.diniargeo.com](http://www.diniargeo.com)

## Main Features

Swivelling column head	As standard, $\pm 160^\circ$ rotation	
Display	25 mm LCD backlit display	
Brightness	Standard brightness	
IP protection rating	IP68	
Accuracy*	Internal use	$\pm 0,5$ kg
	Legal for trade 	In accordance with Directive 2014/31/EU
Keyboard	17-key waterproof	
Structure	Body	Oven-fire painted steel
	Forks	Stainless steel as option
Steering wheels	Double polyurethane rollers	
Load wheels	Double polyurethane loading rollers	
Lift pump	Quick-lifting hydraulic pump	
Load cells	4, ATEX certified, in stainless steel, with IP68 protection	
Auto switch-off	5 min, programmable	
Power supply	ATEX removable rechargeable battery	
Operating time	About 100 h	
Battery recharge (in safe area)	Via a 230 Vac 50 Hz charger (12 h for full recharge) with EU, UK, AU and US power plugs	
Operating temperature range	-10 / +40 °C	
Communication to external devices	Optional radio-frequency and Wi-Fi	

(\*) Weighing of goods on EUROPALLET with distributed load.

## Certifications

- 2006/42/EU (Machine Directive)
- 2014/30/EU (EMC)
- 2014/35/EU (LVD)
- 2011/65/EU (RoHS)
- 2014/31/EU (NAWI)
- 2014/34/EU (ATEX)

## Technical Drawing (mm)

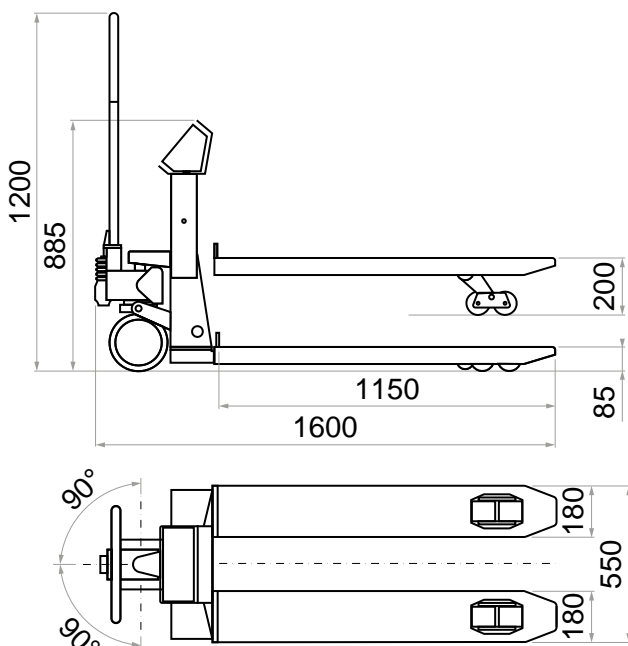

# TPW EX 2GD

2GD ATEX

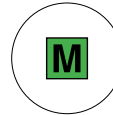

550 mm  
EUROPALLET

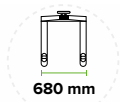

680 mm  
US PALLET



MANUFACTURED  
IN ITALY

Pallet truck scale for ATEX hazardous areas (zones 1 and 21, 2 and 22).

Choose it because:

- Made with ATEX-certified components
- High resolution up to 100 g
- Approved for legal-for-trade use

## Main Functions

- WEIGHT TOTALISATION
- PIECE COUNTING
- UNIT CONVERTER: kg/lb, free conversion factor
- 50 TARE MEMORY
- ZEROING
- TARE
- PRESET TARE

## Version codes

M	Printer	Max. Capacity (kg)	d (kg)	e (kg)	Product Code
		2.000	0,2		TPWX2GD20-x
M		1.000 - 2.000		0,5 - 1	TPWX2GD20M-x

## Main Options

### SPECIAL CALIBRATIONS

M	Max. Capacity (kg)	d (kg)	e (kg)	Option Code
M	600		0,2	FS600M
M	600 - 1.500		0,2 - 0,5	FS1500M2R
M	1.500		0,5	FS1500M
M	1.500 - 2.500		0,5 - 1	FS2500M
	2.000*	0,1		TPWHRES
	2.500**	0,2		FS2500
	Special Capacities / Resolutions: upon request.			-

(\*) Accuracy is the same as the standard version.

(\*\*) Accuracy between 2.000 / 2.500 kg is 2 kg.

### SPECIAL SIZES

Forks for US pallet (680 mm).	TPWWFEX-x
Other Special Sizes upon request.	-
Stainless Steel Forks.	TPWXFI

>> Discover the full range of options and accessories from page 36



Packaging and Weight (see page 84)

M Legal for trade

Printer Integrated Printer and Date & Time

(PRODUCT CODE-x): For the current code version please refer to [www.diniargeo.com](http://www.diniargeo.com)

## Main Features

Swivelling column head		As standard, $\pm 160^\circ$ rotation
Display		25 mm LCD display
Brightness		Standard brightness
IP protection rating		IP68
Accuracy*	Internal use	$\pm 0,5$ kg
	Legal for trade 	In accordance with Directive 2014/31/EU
Keyboard		17-key waterproof
Structure	Body	Oven-fire painted steel
	Forks	Stainless steel as option
Steering wheels		Double polyurethane rollers
Load wheels		Double polyurethane loading rollers
Lift pump		Quick-lifting hydraulic pump
Load cells		4, ATEX certified, in stainless steel, with IP68 protection
Auto switch-off		5 min, programmable
Power supply		ATEX removable rechargeable battery
Operating time		About 150 h
Battery recharge (in safe area)		Via a 230 Vac 50 Hz charger (18 h for full recharge) with EU, UK, AU and US power plugs
Operating temperature range		-10 / +40 °C
Communication to external devices		-

(\*) Weighing of goods on EUROPALLET with distributed load.

## Certifications

- 2006/42/EU (Machine Directive)
- 2014/30/EU (EMC)
- 2014/35/EU (LVD)
- 2011/65/EU (RoHS)
- 2014/31/EU (NAWI)
- 2014/34/EU (ATEX)

## Technical Drawing (mm)

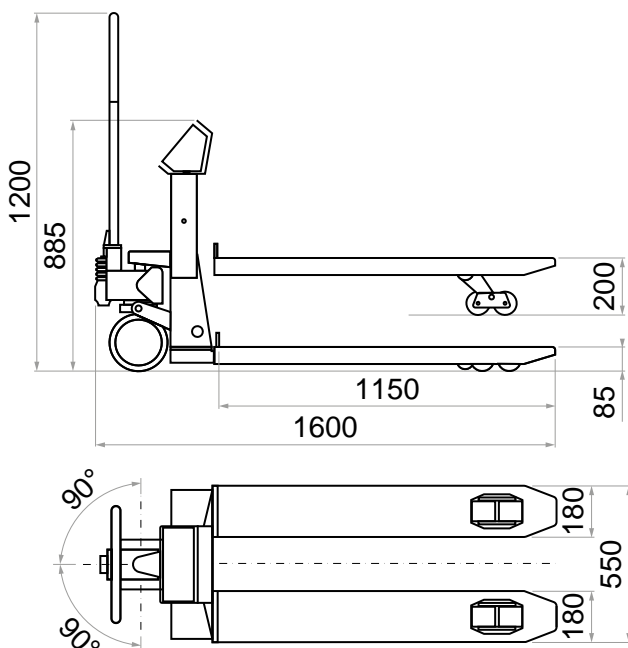

## STAINLESS STEEL PALLET TRUCK SCALES

“

Wide range of stainless steel pallet truck scales, specifically designed for use in environments that require strict hygienic standards or harsh environments.

”

# STAINLESS STEEL PALLET TRUCK SCALES



# TPWI-LK

## LOGISTIC

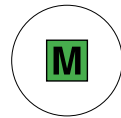

Easy-to-use, robust and durable entry level pallet truck scale in stainless steel.

Choose it because:

- Suitable for any application
- Approved for legal-for-trade use
- Can print and transmit data to major computer systems

### Main Functions

- **WEIGHT TOTALISATION**
- **PIECE COUNTING**
- **UNIT CONVERTER:** kg/lb, free conversion factor
- **50 TARE MEMORY**
- **ZEROING**
- **TARE**
- **PRESET TARE**

### Version codes

		Max. Capacity (kg)	d (kg)	e (kg)	Product Code
		1.000 – 2.000	0,5 - 1		TPWI-LK
		2.000		1	TPWIM-LK

### Main Options

#### SPECIAL CALIBRATIONS

<i>Special Capacities / Resolutions: upon request.</i>	-	
--	---	--

#### SPECIAL SIZES

<i>Other Special Sizes upon request.</i>	-	
--	---	--

>> Discover the full range of options and accessories from page 36



Packaging and Weight (see page 84)

Legal for trade

Integrated Printer and Date & Time

(PRODUCT CODE-x): For the current code version please refer to [www.diniargeo.com](http://www.diniargeo.com)



## Main Features

Display	25 mm LCD backlit display	
Brightness	Adjustable brightness	
IP protection rating	IP65	
Accuracy*	Internal use	± 1 kg
	Legal for trade 	In accordance with Directive 2014/31/EU
Keyboard	17-key waterproof	
Structure	Body	AISI 304 stainless steel
	Forks	AISI 304 stainless steel
Steering wheels	Double nylon rollers	
Load wheels	Double nylon loading rollers	
Lift pump	Stainless steel quick-lifting hydraulic pump	
Load cells	4, in stainless steel, with IP68 protection	
Auto switch-off	5 min, programmable	
Power supply	Integrated rechargeable battery	
Operating time	About 80 h	
Battery recharge	Via a 230 Vac 50 Hz charger (6-8 h for full recharge) with EU power plug**	
Operating temperature range	-10 / +40 °C	
Communication to external devices	Optional radio-frequency, Wi-Fi or Bluetooth	

(\*) Weighing of goods on EUROPALLET with distributed load.

(\*\*) UK, AU, US versions: upon request.

## Certifications

- 2006/42/EU (Machine Directive)
- 2014/30/EU (EMC)
- 2014/35/EU (LVD)
- 2011/65/EU (RoHS)
- 2014/31/EU (NAWI)

## Technical Drawing (mm)

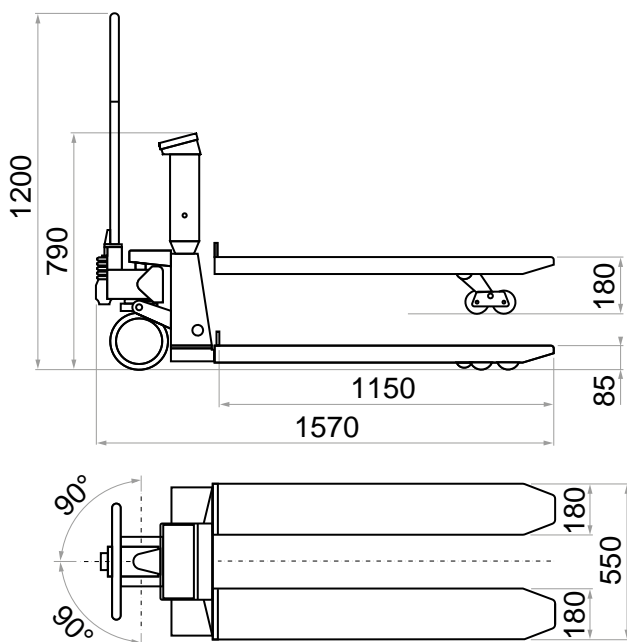

# TPWI-PRO

## MULTIPURPOSE

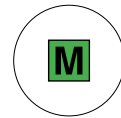

MANUFACTURED  
IN ITALY

AISI 304 stainless steel pallet truck scale, suitable for use in moderately humid environments.

Choose it because:

- Manufactured in Italy with certified components
- Approved for legal-for-trade use
- Can print and transmit data to the main computer systems

### Main Functions

- **WEIGHT TOTALISATION**
- **PIECE COUNTING**
- **UNIT CONVERTER:** kg/lb, free conversion factor
- **50 TARE MEMORY**
- **ZEROING**
- **TARE**
- **PRESET TARE**

### Version codes

		Max. Capacity (kg)	d (kg)	e (kg)	Product Code
		1.000 – 2.000	0,2 - 0,5		<b>TPWI-PRO</b>
		1.000 – 2.000		0,5 - 1	<b>TPWIM-PRO</b>

### Main Options

#### SPECIAL CALIBRATIONS

	Max. Capacity (kg)	d (kg)	e (kg)	Option Code
	600 - 1.500		0,2 - 0,5	<b>FS1500M2R</b>
	1.500		0,5	<b>FS1500M</b>
	1.500 - 2.500		0,5 - 1	<b>FS2500M</b>
	2.500**	0,2		<b>FS2500</b>
	<i>Special Capacities / Resolutions: upon request.</i>			-

(\*\*) Accuracy between 2.000 / 2.500 kg is 2 kg.

#### SPECIAL SIZES

<i>Other Special Sizes upon request.</i>	-
--	---

>> Discover the full range of options and accessories from page 36



Packaging and Weight (see page 84)

Legal for trade

Integrated Printer and Date & Time

(PRODUCT CODE-x): For the current code version please refer to [www.diniargeo.com](http://www.diniargeo.com)

## Main Features

Display	25 mm LCD display	
Brightness	Adjustable brightness	
IP protection rating	IP65	
Accuracy*	Internal use	± 1 kg
	Legal for trade 	In accordance with Directive 2014/31/EU
Keyboard	17-key waterproof	
Structure	Body	AISI 304 stainless steel
	Forks	AISI 304 stainless steel
Steering wheels	Double nylon rollers with polyurethane coating	
Load wheels	Double nylon loading rollers with polyurethane coating	
Lift pump	Stainless steel quick-lifting hydraulic pump	
Load cells	4, in stainless steel, with IP68 protection	
Auto switch-off	5 min, programmable	
Power supply	Integrated rechargeable battery	
Operating time	About 50 h	
Battery recharge	Via a 230 Vac 50 Hz charger (8 h for full recharge) with EU, UK,AU and US power plugs	
Operating temperature range	-10 / +40 °C	
Communication to external devices	Optional radio-frequency, Wi-Fi or Bluetooth	

(\* ) Weighing of goods on EUROPALLET with distributed load.

## Certifications

- 2006/42/EU (Machine Directive)
- 2014/30/EU (EMC)
- 2014/35/EU (LVD)
- 2011/65/EU (RoHS)
- 2014/31/EU (NAWI)

## Technical Drawing (mm)

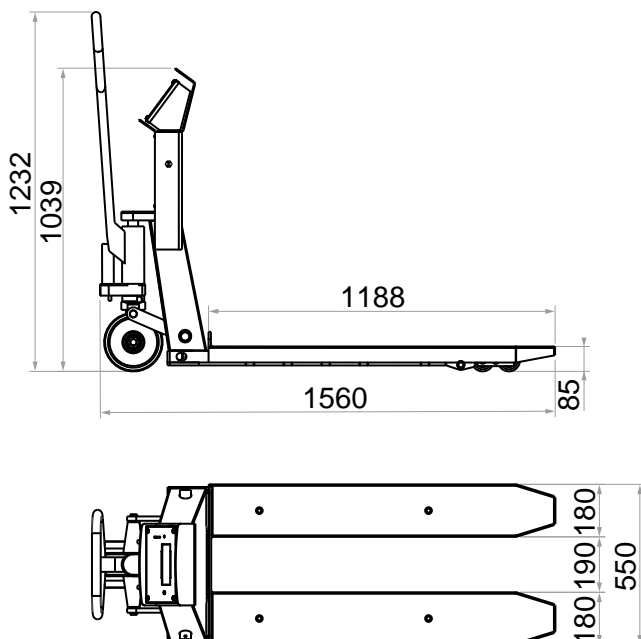

# TPWI HYGIENX

FOOD, CHEMICAL AND  
PHARMACEUTICAL INDUSTRY



MANUFACTURED  
IN ITALY



AISI 304 stainless steel pallet truck scale specifically designed for environments with high hygiene requirements, such as the food industry food, chemical and pharmaceutical industries and manufactured according to GMP standards.

Choose it because:

- Made with IP69K load cells, hermetically sealed, for maximum protection against water and corrosion
- Fully washable and sanitazable
- Approved for legal-for-trade use

## Main Functions

- **WEIGHT TOTALISATION**
- **PIECE COUNTING**
- **UNIT CONVERTER:** kg/lb, free conversion factor
- **50 TARE MEMORY**
- **ZEROING**
- **TARE**
- **PRESET TARE**

## Version codes

		Max. Capacity (kg)	d (kg)	e (kg)	Product Code
		1.000 – 2.000	0,2 – 0,5		TPWI-HGX
		1.000 – 2.000		0,5 - 1	TPWIM-HGX

## Main Options

### SPECIAL CALIBRATIONS

	Max. Capacity (kg)	d (kg)	e (kg)	Option Code
	600 - 1.500		0,2 - 0,5	FS1500M2R
	1.500		0,5	FS1500M
	1.500 - 2.500		0,5 - 1	FS2500M
	2.500**	0,2		FS2500
Special Capacities / Resolutions: upon request.				-

(\*\*) Accuracy between 2.000 / 2.500 kg is 2 kg.

### SPECIAL SIZES

Other Special Sizes upon request.	-
-----------------------------------	---

>> Discover the full range of options and accessories from page 36



Packaging and Weight (see page 84)

Legal for trade

Integrated Printer and Date & Time

(PRODUCT CODE-x): For the current code version please refer to [www.diniargeo.com](http://www.diniargeo.com)

## Main Features

Display	25 mm LCD backlit display	
Brightness	Adjustable brightness	
IP protection rating	IP68 / IP69K	
Accuracy*	Internal use	± 0,5 kg
	Legal for trade 	In accordance with Directive 2014/31/EU
Keyboard	17 numeric-functional waterproof keyboard	
Structure	Body	AISI 304 stainless steel
	Forks	AISI 304 stainless steel
Steering wheels	Double nylon rollers with polyurethane coating	
Load wheels	Double nylon loading rollers with polyurethane coating	
Lift pump	AISI 304 Stainless steel quick-lifting hydraulic pump	
Load cells	4, in stainless steel, with IP69K protection	
Auto switch-off	Programmable	
Power supply	Integrated rechargeable battery	
Operating time	About 100 h	
Battery recharge	Via a 230 Vac 50 Hz charger (12 h for full recharge) with EU power plug**	
Operating temperature range	-10 / +40 °C	
Communication to external devices	Optional radio-frequency, Wi-Fi or Bluetooth	

(\*) Weighing of goods on EUROPALLET with distributed load.

(\*\*) UK, AU, US versions: upon request.

## Certifications

- 2006/42/EU (Machine Directive)
- 2014/30/EU (EMC)
- 2014/35/EU (LVD)
- 2011/65/EU (RoHS)
- 2014/31/EU (NAWI)

## Technical Drawing (mm)

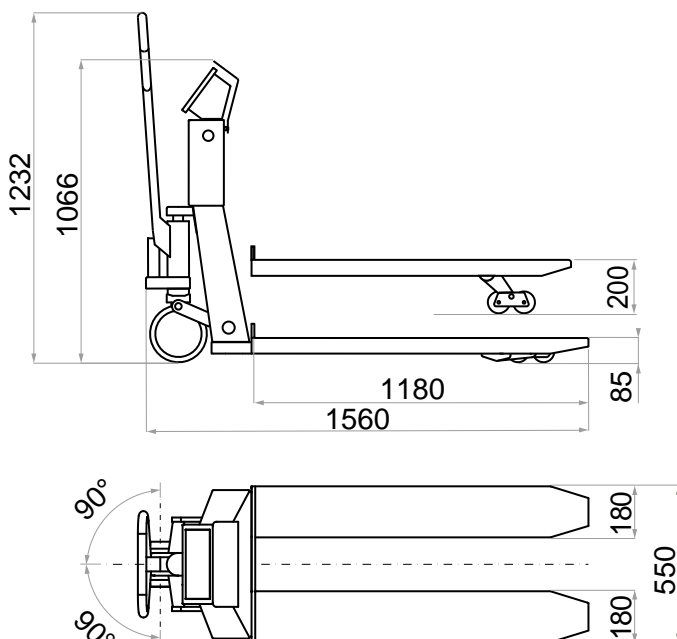

# TPWI-PRO "EX" 3GD

3GD ATEX

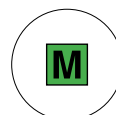
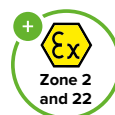

 MANUFACTURED IN ITALY

Stainless steel pallet truck scale for ATEX hazardous areas (zones 2 and 22).

Choose it because:

- Made with ATEX-certified components
- Approved for legal-for-trade use
- Can transmit data to safe zone

## Main Functions



- **WEIGHT TOTALISATION**
- **PIECE COUNTING**
- **UNIT CONVERTER:** kg/lb, free conversion factor
- **50 TARE MEMORY**
- **ZEROING**
- **TARE**
- **PRESET TARE**

## Version codes

		Max. Capacity (kg)	d (kg)	e (kg)	Product Code
		1.000 - 2.000	0,2 - 0,5		TPWI-PRO-EX3GD
		1.000 - 2.000		0,5 - 1	TPWIM-PRO-EX3GD

## Main Options

### SPECIAL CALIBRATIONS

	Max. Capacity (kg)	d (kg)	e (kg)	Option Code
	600 - 1.500		0,2 - 0,5	FS1500M2R
	1.500		0,5	FS1500M
	1.500 - 2.500		0,5 - 1	FS2500M
	2.500**	0,2		FS2500
	Special Capacities / Resolutions: upon request.			-

(\*\*) Accuracy between 2.000 / 2.500 kg is 2 kg.

### SPECIAL SIZES

Other Special Sizes upon request.	-
-----------------------------------	---

>> Discover the full range of options and accessories from page 36



Packaging and Weight (see page 84)

 Legal for trade

 Integrated Printer and Date & Time

(PRODUCT CODE-x): For the current code version please refer to [www.diniargeo.com](http://www.diniargeo.com)

## Main Features

Display	25 mm LCD backlit display	
Brightness	Standard brightness	
IP protection rating	IP68	
Accuracy*	Internal use	± 1 kg
	Legal for trade 	In accordance with Directive 2014/31/EU
Keyboard	17-key waterproof	
Structure	Body	AISI 304 stainless steel
	Forks	AISI 304 stainless steel
Steering wheels	Double antistatic rollers	
Load wheels	Double polyurethane loading rollers	
Lift pump	Stainless steel quick-lifting hydraulic pump	
Load cells	4, ATEX certified, in stainless steel, with IP68 protection	
Auto switch-off	5 min, programmable	
Power supply	ATEX removable rechargeable battery	
Operating time	About 100 h	
Battery recharge (in safe area)	Via a 230 Vac 50 Hz charger (8 h for full recharge) with EU, UK, AU and US power plugs	
Operating temperature range	-10 / +40 °C	
Communication to external devices	Optional radio-frequency and Wi-Fi	

(\* ) Weighing of goods on EUROPALLET with distributed load.

## Certifications

- 2006/42/EU (Machine Directive)
- 2014/30/EU (EMC)
- 2014/35/EU (LVD)
- 2011/65/EU (RoHS)
- 2014/31/EU (NAWI)
- 2014/34/EU (ATEX)

## Technical Drawing (mm)

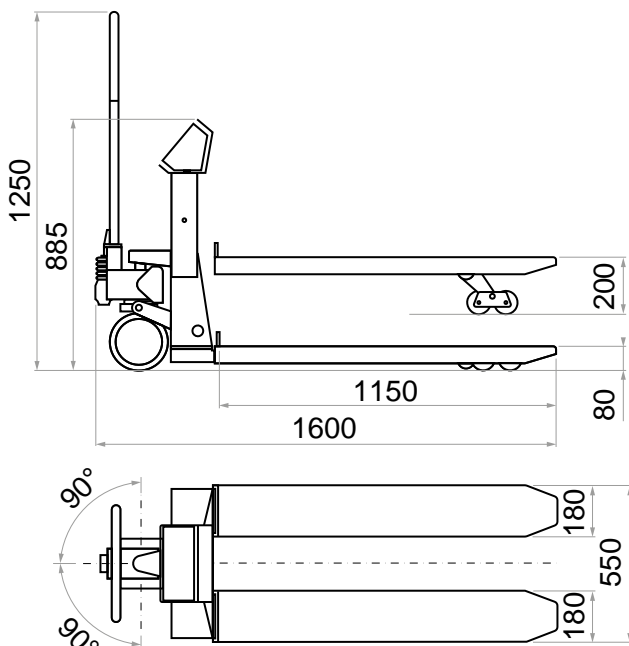

# TPWI-PRO "EX" 2GD

2GD ATEX



 MANUFACTURED IN ITALY

Stainless steel pallet truck scale for ATEX hazardous areas (zones 1 and 21, 2 and 22).



Choose it because:

- Made with ATEX-certified components
- Approved for legal-for-trade use
- Fitted with long-lasting removable battery

## Main Functions





- **WEIGHT TOTALISATION**
- **PIECE COUNTING**
- **UNIT CONVERTER:** kg/lb, free conversion factor
- **50 TARE MEMORY**
- **ZEROING**
- **TARE**
- **PRESET TARE**

## Version codes

		Max. Capacity (kg)	d (kg)	e (kg)	Product Code
		1.000 - 2.000	0,2 - 0,5		TPWI-PRO-EX2GD
		1.000 - 2.000		0,5 - 1	TPWIM-PRO-EX2GD

## Main Options

### SPECIAL CALIBRATIONS

	Max. Capacity (kg)	d (kg)	e (kg)	Option Code
	600 - 1.500		0,2 - 0,5	FS1500M2R
	1.500		0,5	FS1500M
	1.500 - 2.500		0,5 - 1	FS2500M
	2.500**	0,2		FS2500
	<i>Special Capacities / Resolutions: upon request.</i>			-

(\*\*) Accuracy between 2.000 / 2.500 kg is 2 kg.

### SPECIAL SIZES

<i>Other Special Sizes upon request.</i>	-
--	---

>> Discover the full range of options and accessories from page 36



Packaging and Weight (see page 84)

 Legal for trade

 Integrated Printer and Date & Time

(PRODUCT CODE-x): For the current code version please refer to [www.diniargeo.com](http://www.diniargeo.com)



## Main Features

Display	LCD	
Brightness	Standard brightness	
IP protection rating	IP68	
Accuracy*	Internal use	± 1 kg
	Legal for trade 	In accordance with Directive 2014/31/EU
Keyboard	17-key waterproof	
Structure	Body	AISI 304 stainless steel
	Forks	AISI 304 stainless steel
Steering wheels	Double antistatic rollers	
Load wheels	Double polyurethane loading rollers	
Lift pump	Stainless steel quick-lifting hydraulic pump	
Load cells	4, ATEX certified, in stainless steel, with IP68 protection	
Auto switch-off	5 min, programmable	
Power supply	ATEX removable rechargeable battery	
Operating time	About 150 h	
Battery recharge (in safe area)	Via a 230 Vac 50 Hz charger (18 h for full recharge) with EU, UK, AU and US power plugs	
Operating temperature range	-10 / +40 °C	
Communication to external devices	-	

(\*) Weighing of goods on EUROPALLET with distributed load.

## Certifications

- 2006/42/EU (Machine Directive)
- 2014/30/EU (EMC)
- 2014/35/EU (LVD)
- 2011/65/EU (RoHS)
- 2014/31/EU (NAWI)
- 2014/34/EU (ATEX)

## Technical Drawing (mm)

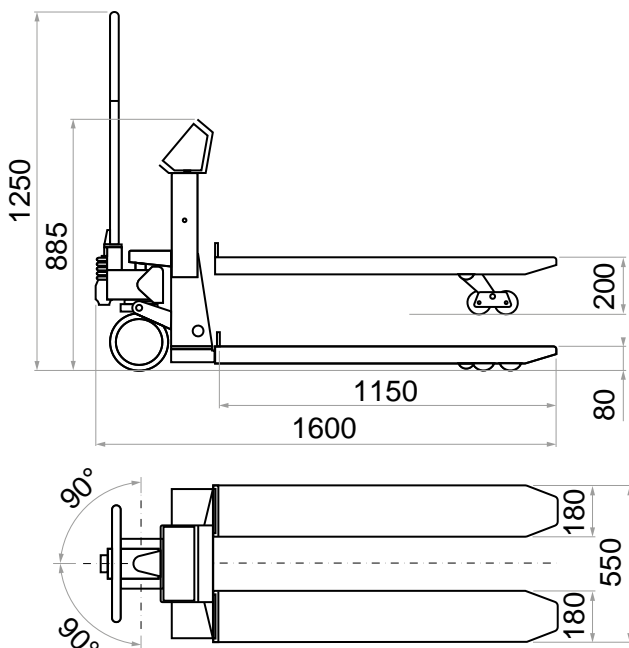



## ELECTRIC PALLET TRUCK SCALES

“

Innovative solutions to facilitate handling  
inside the warehouse.

”

# ELECTRIC PALLET TRUCK SCALES

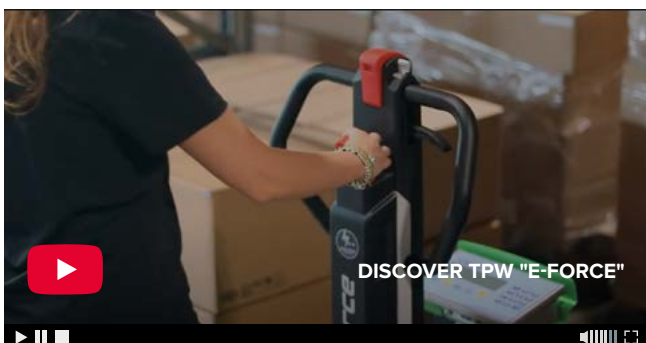

Watch the video to find out more:  
**THE ELECTRIC PALLET TRUCK SCALE  
FOR YOUR WAREHOUSE**



[www.diniargeo.com](http://www.diniargeo.com)

# TPW "E-FORCE"

ELECTRIC TRACTION TILLER



Innovative pallet truck scale with electric traction tiller that makes weighing and handling extremely easy.

Choose it because:

- Electric tiller
- Extra slim body ideal for narrow places
- 100 g resolution for very accurate weighing







 MANUFACTURED IN ITALY

## Main Functions

- WEIGHT TOTALISATION
- PIECE COUNTING
- UNIT CONVERTER: kg/lb, free conversion factor
- 50 TARE MEMORY
- ZEROING
- TARE
- PRESET TARE

## Version codes

		Max. Capacity (kg)	d (kg)	e (kg)	Product Code
		1.250	0,1		TPWE-FORCE-x
		1.250		0,5	TPWE-FORCEM-x

## Main Options

SPECIAL CALIBRATIONS

<i>Special Capacities / Resolutions: upon request.</i>	-	
--	---	--

SPECIAL SIZES

<i>Other Special Sizes upon request.</i>	-	
--	---	--

>> Discover the full range of options and accessories from page 36



Packaging and Weight (see page 84)

 Legal for trade

 Integrated Printer and Date & Time

(PRODUCT CODE-x): For the current code version please refer to [www.dinargeo.com](http://www.dinargeo.com)

## Main Features

Maximum speed		5 km/h
Maximum slope		5%
Display		25 mm LCD backlit display
Brightness		Adjustable brightness
IP protection rating		IP54
Precision*	Internal use	± 0,5 kg
	Legal for trade 	In accordance with Directive 2014/31/EU
Keyboard		17-key waterproof
Structure		Oven-fire painted steel
Steering wheels		Double stain-resistant rubber rollers
Load wheels		Double polyurethane loading rollers
Lift pump		Quick-lifting hydraulic pump
Load cells		4, in stainless steel, with IP68 protection for legal-for-trade approved version, IP67 for internal use version
Auto switch-off		5 min, programmable
Power supply	Indicator	Removable rechargeable Instaplug battery
	Tiller	Removable rechargeable lithium-ion battery
Operating time	Indicator	Approx. 80 h
	Tiller	Up to 8 h (3 to 5 h for standard use)
Battery recharge	Indicator	Via a 230 Vac 50 Hz charger (8 h for full recharge) with EU power plug**
	Tiller	Optional 2 h quick recharge
Operating temperature range		-10 / +40 °C
Communication to external devices		Optional radio-frequency, Wi-Fi or Bluetooth

(\*) Weighing of goods on EUROPALLET with distributed load.

(\*\*) UK, AU, US versions: upon request.

## Certifications





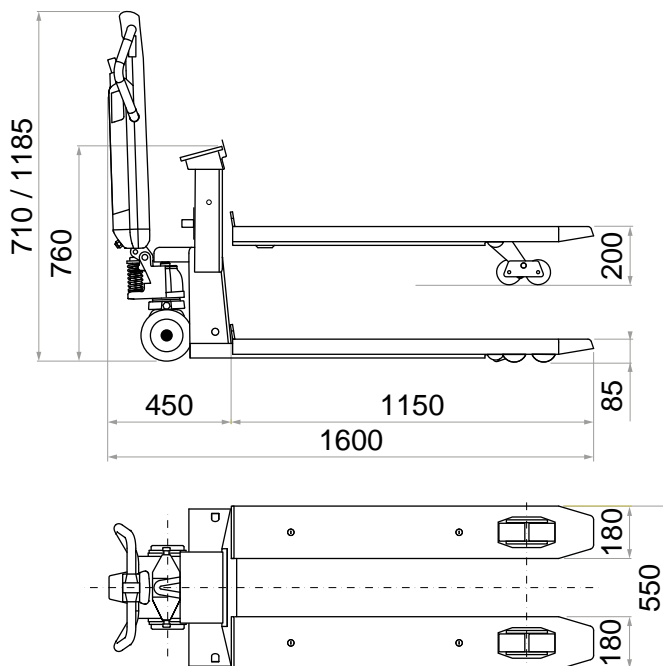







- 2006/42/EU (Machine Directive)
- 2014/30/EU (EMC)
- 2014/35/EU (LVD)
- 2011/65/EU (RoHS)
- 2014/31/EU (NAWI)

## Technical Drawing (mm)



# MAIN OPTIONS **AND ACCESSORIES LIST**

## Accessories

	TPWN	TPWLK	TPWP	TPW TOUCH	TPW EX 3GD	TPW EX 2GD	TPWI-LK	TPWI-PRO	TPWI HYGIENX	TPWI-PRO "EX" 3GD	TPWI-PRO "EX" 2GD	TPW "E-FORCE"		Description	Code
<b>KEYBOARD PROTECTION COVER</b>	○													Kit of 10 anti-shock moulded protective covers in transparent plastic.	<b>CVRTPWN</b>
			○	○										Kit of 10 moulded protective covers in transparent plastic.	<b>CVRXP</b>
<b>STEERING WHEELS</b>		○	○	○	○	○				●	●			Set of antistatic steering wheels.*	<b>TPWRAS</b>
		○	○	○										Set of nylon steering wheels.*	<b>TPWRNY</b>
		○	○	○			○							Set of vulkollan steering wheels (stain-resistant).*	<b>RTV2</b>
<b>PARKING BRAKE</b>			○	○	○	○								Parking brake system with command pedal.	<b>TPWFRE</b>
	○	○	○	○	○	○								Parking brake system with command pedal for wide fork version (TPWWF-x), mounted on steering wheels. Please note: This brake is not compatible with the accessory wheels for this product.	<b>TPWFRE-x</b>
							○							Stainless steel parking brake system with command pedal.	<b>TPWIFRE-x</b>
								○	○	○	○			Stainless steel parking brake system with command pedal mounted on steering wheels. For TPWI-PRO series pallet truck scales.	<b>TPWIBRK</b>
<b>STAINLESS STEEL FORKS</b>		○	○	○	○	○								Pair of stainless steel forks.	<b>TPWXFI</b>
<b>SWIVELLING HEAD</b>							○		○	○			Stainless steel swivelling head.	<b>TPWISWH-x</b>	

(\* Please note: when combined with wide fork frame, the steering wheels do not allow fitting of the TPWFRE-x parking brake

● As standard ○ Optional



Packaging and Weight (see page 84)

 Installation at time of order.

 Installation at time of order.

 Installation at time of order.

(PRODUCT CODE-x): For the current code version please refer to [www.diniargeo.com](http://www.diniargeo.com)

## Application Programs

	TPWN	TPWLK	TPWP	TPW TOUCH	TPW EX 3GD	TPW EX 2GD	TPWI-LK	TPWI-PRO	TPWI HYGIENX	TPWI-PRO "EX" 3GD	TPWI-PRO "EX" 2GD	TPW "E-FORCE"		Description	Code
APPLICATION SOFTWARE				<input type="checkbox"/>										Software for piece / quantity counting.	AF02
				<input type="checkbox"/>										Software for price computing and industrial labelling.	AF05

## Options for Communication

	TPWN	TPWLK	TPWP	TPW TOUCH	TPW EX 3GD	TPW EX 2GD	TPWI-LK	TPWI-PRO	TPWI HYGIENX	TPWI-PRO "EX" 3GD	TPWI-PRO "EX" 2GD	TPW "E-FORCE"		Description	Code
PC SOFTWARE FOR DATA STORAGE		<input type="checkbox"/>	<input type="checkbox"/>	<input type="checkbox"/>	<input type="checkbox"/>		<input type="checkbox"/>	<input type="checkbox"/>	<input type="checkbox"/>			<input type="checkbox"/>		PC program to record all weighs in real time. Price is intended for one scale only.	SWM
USB DATA STORAGE		<input type="checkbox"/>	<input type="checkbox"/>	<input type="checkbox"/>								<input type="checkbox"/>		USB port kit installed on the pallet truck scale column, complete of USB key for PC.	USBCTPW-x
							<input type="checkbox"/>							Built-in USB port to store data on a USB driver. Fitted with USB key for PC.	USBDFWL-x
			<input type="checkbox"/>	<input type="checkbox"/>			<input type="checkbox"/>					<input type="checkbox"/>		Set of 5 USB keys to record the weighs.	USBK
					<input type="checkbox"/>									8 GB internal memory.	TPWMEM3GD-x
CONNECTION CABLES				<input type="checkbox"/>										USB 1,5 m connection cable for configuration of the pallet truck scales.	RSCBUSB-x

● As standard    ○ Optional



Packaging and Weight (see page 84)

Installation at time of order.

Installation at time of order.

Installation at time of order.

(PRODUCT CODE-x): For the current code version please refer to [www.diniargeo.com](http://www.diniargeo.com)



## Options for Communication

	TPWN	TPWLK	TPWP	TPW TOUCH	TPW EX 3GD	TPW EX 2GD	TPWI-LK	TPWI-PRO	TPWI HYGIENX	TPWI-PRO "EX" 3GD	TPWI-PRO "EX" 2GD	TPW "E-FORCE"													
														for TPW	for PC	INDOOR	OUTDOOR	PLUG	Code						
<b>BLUETOOTH INTERFACE</b>		<input type="radio"/>	<input type="radio"/>	<input type="radio"/>			<input type="radio"/>	<input type="radio"/>	<input type="radio"/>			<input type="radio"/>		<input checked="" type="checkbox"/>		10	10	AMP	BLTH-x						
<b>Wi-Fi</b>		<input type="radio"/>	<input type="radio"/>	<input type="radio"/>			<input type="radio"/>					<input type="radio"/>		<input checked="" type="checkbox"/>		70	70	AMP	WIFITPWLK-x						
								<input type="radio"/>				<input type="radio"/>		<input checked="" type="checkbox"/>		70	70	AMP	WIFITD69K						
					<input type="radio"/>					<input type="radio"/>		<input type="radio"/>		<input checked="" type="checkbox"/>		30	70	AMP	OBWIFI3GD-x*						
<b>RADIO 2.4 GHz EMITTER</b>		<input type="radio"/>	<input type="radio"/>	<input type="radio"/>			<input type="radio"/>	<input type="radio"/>	<input type="radio"/>			<input type="radio"/>		<input checked="" type="checkbox"/>		70	150	AMP	RF2G4						
					<input type="radio"/>					<input type="radio"/>		<input type="radio"/>		<input checked="" type="checkbox"/>		70	150	AMP	OBRF2G4-3GD*						
<b>RADIO 2.4 GHz RECEIVER</b>		<input type="radio"/>	<input type="radio"/>	<input type="radio"/>			<input type="radio"/>	<input type="radio"/>				<input type="radio"/>			<input checked="" type="checkbox"/>	70	150	USB	OBRF2G4-USB						
<b>DATE &amp; TIME</b>							<input type="radio"/>	<input type="radio"/>						<input checked="" type="checkbox"/>	Real time clock for printing /displaying of date and time.				DFCLK						
<b>FISCAL MEMORY</b>		<input type="radio"/>	<input type="radio"/>	<input type="radio"/>			<input type="radio"/>	<input type="radio"/>	<input type="radio"/>	<input type="radio"/>		<input type="radio"/>		<input checked="" type="checkbox"/>	Alibi memory (fiscal memory, max. 120.000 weighs) with integrated real time clock.				ALMEM-x						

(\*) ABS case

## Calibration Service

	TPWN	TPWLK	TPWP	TPW TOUCH	TPW EX 3GD	TPW EX 2GD	TPWI-LK	TPWI-PRO	TPWI HYGIENX	TPWI-PRO "EX" 3GD	TPWI-PRO "EX" 2GD	TPW "E-FORCE"	Description	Code		
<b>ISO 17025 CALIBRATION CERTIFICATE</b> (only at time of order)													<input type="radio"/> For capacity from 301 kg up to 1.500 kg.	CT6		
	<input type="radio"/>	<input type="radio"/>	<input type="radio"/>	<input type="radio"/>	<input type="radio"/>	<input type="radio"/>	<input type="radio"/>	<input type="radio"/>	<input type="radio"/>	<input type="radio"/>	<input type="radio"/>	<input type="radio"/>	For capacity from 1.501 kg up to 3.000 kg.	CT7		

● As standard      ○ Optional



Packaging and Weight (see page 84)







Installation at time of order.

Installation at time of order.

Installation at time of order.





(PRODUCT CODE-x): For the current code version please refer to [www.diniargeo.com](http://www.diniargeo.com)

## Printers and Expandable Materials

	TPWN	TPWLK	TPWP	TPW TOUCH	TPW EX 3GD	TPW EX 2GD	TPWI-LK	TPWI-PRO	TPWI HYGIENX	TPWI-PRO "EX" 3GD	TPWI-PRO "EX" 2GD	TPW "E-FORCE"		Description	Code	
<b>PRINTERS</b>							<input type="checkbox"/>	<input type="checkbox"/>						IP65 stainless steel thermal printer, with ABS door. For pallet truck column.	<b>TPRXTP</b>	
<b>CUSTOMISATION SERVICES</b>			<input type="checkbox"/>											Custom-made ticket (up to 4 layouts).	<b>PRNSERV</b>	
<b>EXPANDABLE MATERIALS</b>		<input type="checkbox"/>	<input type="checkbox"/>	<input type="checkbox"/>			<input type="checkbox"/>	<input type="checkbox"/>	<input type="checkbox"/>			<input type="checkbox"/>		50 thermal paper rolls 30 m long, 57 mm wide.	<b>RPT57C</b>	
		<input type="checkbox"/>	<input type="checkbox"/>	<input type="checkbox"/>			<input type="checkbox"/>	<input type="checkbox"/>	<input type="checkbox"/>			<input type="checkbox"/>		50 adhesive thermal paper rolls 15 m long, 57 mm wide.	<b>RPT57AC</b>	
		<input type="checkbox"/>	<input type="checkbox"/>	<input type="checkbox"/>			<input type="checkbox"/>	<input type="checkbox"/>	<input type="checkbox"/>			<input type="checkbox"/>		72 rolls of Linerless thermal sticker paper 21 m long, 55 mm wide.	<b>LNLESS</b>	

(\*) NET PRICE

## Batteries and Battery Chargers

	TPWN	TPWLK	TPWP	TPW TOUCH	TPW EX 3GD	TPW EX 2GD	TPWI-LK	TPWI-PRO	TPWI HYGIENX	TPWI-PRO "EX" 3GD	TPWI-PRO "EX" 2GD	TPW "E-FORCE"		Description	Code	
<b>ADDITIONAL REMOVABLE BATTERIES</b>		<input type="checkbox"/>	<input type="checkbox"/>	<input type="checkbox"/>								<input type="checkbox"/>		INSTAPLUG additional removable battery.	<b>INSTAPLUGBK-x</b>	
						<input type="checkbox"/>						<input type="checkbox"/>		Additional ATEX battery for 1 & 21 zones.	<b>DFWBP76ATEXD</b>	
					<input type="checkbox"/>					<input type="checkbox"/>		<input type="checkbox"/>		Additional ATEX battery for 2 & 22 zones.	<b>BP6ESTATEX3GD</b>	
												<input type="checkbox"/>		Additional rechargeable battery.	<b>E-PACK-x</b>	
<b>BATTERY CHARGER</b>												<input type="checkbox"/>		Quick battery charging station (2 h). For bench use or wall mounting.	<b>E-CHARGE</b>	

● As standard    ○ Optional



Packaging and Weight (see page 84)









 Installation at time of order.

 Installation at time of order.

 Installation at time of order.

(PRODUCT CODE-x): For the current code version please refer to [www.diniargeo.com](http://www.diniargeo.com)

## International Power Plugs

	TPWN	TPWLK	TPWP	TPW TOUCH	TPW EX 3GD 	TPW EX 2GD 	TPWI-LK	TPWI-PRO	TPWI HYGIENX	TPWI-PRO "EX" 3GD 	TPWI-PRO "EX" 2GD 	TPW "E-FORCE"		Description	Code
<b>UK VERSION</b>	<input type="radio"/>	<input type="radio"/>	<input type="radio"/>	<input type="radio"/>	<input checked="" type="radio"/>	<input checked="" type="radio"/>	<input type="radio"/>	<input checked="" type="radio"/>	<input type="radio"/>	<input checked="" type="radio"/>	<input checked="" type="radio"/>	<input type="radio"/>		Version with UK plug.	<b>UK-V3</b>
<b>AU VERSION</b>	<input type="radio"/>	<input type="radio"/>	<input type="radio"/>	<input type="radio"/>	<input checked="" type="radio"/>	<input checked="" type="radio"/>	<input type="radio"/>	<input checked="" type="radio"/>	<input type="radio"/>	<input checked="" type="radio"/>	<input checked="" type="radio"/>	<input type="radio"/>		Version with AU plug.	<b>AUS-V3</b>
<b>US VERSION</b>	<input type="radio"/>	<input type="radio"/>	<input type="radio"/>	<input type="radio"/>	<input checked="" type="radio"/>	<input checked="" type="radio"/>	<input type="radio"/>	<input checked="" type="radio"/>	<input type="radio"/>	<input checked="" type="radio"/>	<input checked="" type="radio"/>	<input type="radio"/>		Version with US plug.	<b>US-V3</b>

NOTES

● As standard      ○ Optional



Packaging and Weight (see page 84)

 Installation at time of order.

 Installation at time of order.

 Installation at time of order.

(PRODUCT CODE-x): For the current code version please refer to [www.diniargeo.com](http://www.diniargeo.com)

## PALLET SCALES

“

Weigh pallets wherever you want. Easy to place and remove according to your logistic needs. It occupies the surface only temporarily and can be used together with hand pallet trucks.

”

# PALLET SCALES

**Pallet scales are the ideal solution for those who want to include weighing in their daily operations with standard pallet trucks or forklifts.**

They are compatible with all EUROPALLET / EPAL and are the cheapest solution to integrate weighing into the warehouse.

Thanks to the wheels underneath the pallet scale, you can move it and position it wherever you want.

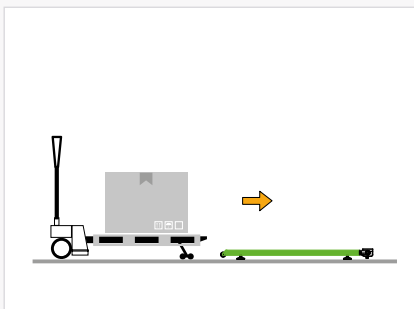

- Place the material to be weighed on the pallet scale

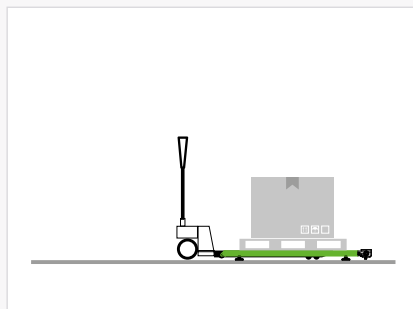

- Start weighing

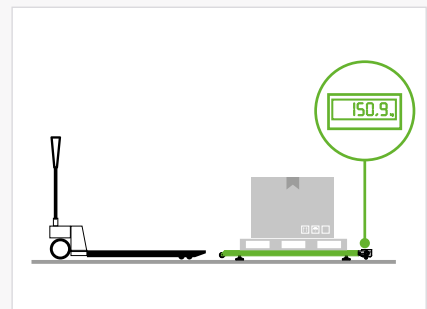

- The weight appears on the display

# EPWL

## STANDARD

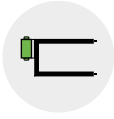

**INDICATOR ATTACHED**  
to the platform

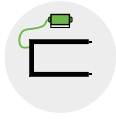

**INTEGRATED INDICATOR**  
cable up to 3 m

Fast and accurate pallet scales, ideal for weighing pallets wherever needed.

Choose it because:

- It can be easily moved and installed anywhere
- Easy to use with hand pallet trucks
- Approved for legal-for-trade use





 **MANUFACTURED IN ITALY**

### Main Functions

- **WEIGHT TOTALISATION**
- **PIECE COUNTING**
- **UNIT CONVERTER:** kg/lb, free conversion factor
- **ZEROING**
- **TARE**
- **PRESET TARE**

### Version codes

		Max. Capacity (kg)	d (kg)	e (kg)	Product Code
		600 - 1.500 - 2.000	0,2 - 0,5 - 1		EPWL-x
		1.000 - 2.000		0,5 - 1	EPWLM-x

### Main Options

#### SPECIAL CALIBRATIONS

Special Capacities / Resolutions: upon request.	-	
---	---	--

#### SPECIAL MODELS

Other Special Models upon request.	-	
------------------------------------	---	--

**>> Discover the full range of options and accessories from page 48**



Packaging and Weight (see page 84)

 Legal for trade

 Integrated Printer and Date & Time

(PRODUCT CODE-x): For the current code version please refer to [www.dinargeo.com](http://www.dinargeo.com)

## Main Features

Indicator	Attached to the pallet scale or wall / column mounted	
Connection cable	3 m	
Display	25 mm LCD backlit display	
Brightness	Adjustable brightness	
IP protection rating	IP54	
Accuracy*	Internal use	± 1 kg
	Legal for trade 	In accordance with Directive 2014/31/EU
Keyboard	5-key waterproof	
Structure	Oven-fire painted steel	
Adjustable feet	As standard	
Wheels	As standard	
Transport handle	As standard	
Load cells	4, in nickel-plated, with IP67 protection	
Auto switch-off	Programmable	
Power supply	4 AA batteries or 12 Vdc, with EU, UK, AU and US power plugs	
Operating time	About 40 h	
Operating temperature range	-10 / +40 °C	
Communication to external devices	Optional Bluetooth	

(\*) Weighing of goods on EUROPALLET with distributed load.

## Certifications

- 2014/30/EU (EMC)
- 2014/35/EU (LVD)
- 2011/65/EU (RoHS)
- 2014/31/EU (NAWI)

## Technical Drawing (mm)

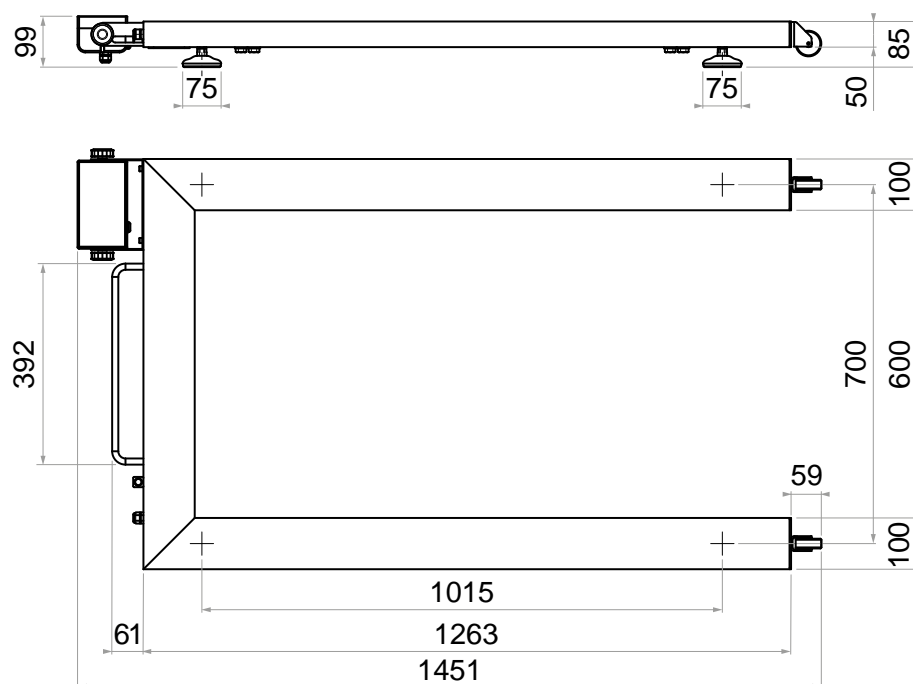

# EPWLI

## STAINLESS STEEL

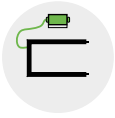

**INTEGRATED INDICATOR**  
cable up to 3 m



  
MANUFACTURED IN ITALY

A quick and accurate solution to weigh pallets wherever you need it. Fully made in stainless steel, ideal for chemical, pharmaceutical and food industry.



Choose it because:

- It can be easily moved and installed anywhere
- It can be used in outdoor applications or in harsh environments
- Approved for legal-for-trade use

### Main Functions

- **WEIGHT TOTALISATION**
- **PIECE COUNTING**
- **UNIT CONVERTER:** kg/lb, free conversion factor
- **ZEROING**
- **TARE**
- **PRESET TARE**

### Version codes

		Max. Capacity (kg)	d (kg)	e (kg)	Product Code
		600 - 1.500 - 2.000	0,2 - 0,5 - 1		EPWLI-x
		1.000 - 2.000		0,5 - 1	EPWLIM-x

### Main Options

#### SPECIAL CALIBRATIONS

Special Capacities / Resolutions: upon request.	-	
---	---	--

#### SPECIAL MODELS

Other Special Models upon request.	-	
------------------------------------	---	--

>> Discover the full range of options and accessories from page 48



Packaging and Weight (see page 84)

 Legal for trade

 Integrated Printer and Date & Time

(PRODUCT CODE-x): For the current code version please refer to [www.dinargeo.com](http://www.dinargeo.com)



## Main Features

Indicator	Wall / Column mounted	
Connection cable	3 m	
Display	25 mm LCD backlit display	
Brightness	Adjustable brightness	
IP protection rating	IP68 weight indicator	
Accuracy*	Internal use	± 1 kg
	Legal for trade 	In accordance with Directive 2014/31/EU
Keyboard	5-key waterproof	
Structure	Stainless steel	
Adjustable feet	As standard	
Wheels	As standard	
Transport handle	As standard	
Load cells	4, in stainless steel, with IP67 protection	
Auto switch-off	5 min, programmable	
Power supply	110 - 240 Vac, with EU power cord**	
Operating temperature range	-10 / +40 °C	
Communication to external devices	Optional Ethernet and Bluetooth	

(\*) Weighing of goods on EUROPALLET with distributed load.

(\*\*) UK, AU, US versions: upon request.

## Certifications

- 2014/30/EU (EMC)
- 2014/35/EU (LVD)
- 2011/65/EU (RoHS)
- 2014/31/EU (NAWI)

## Technical Drawing (mm)

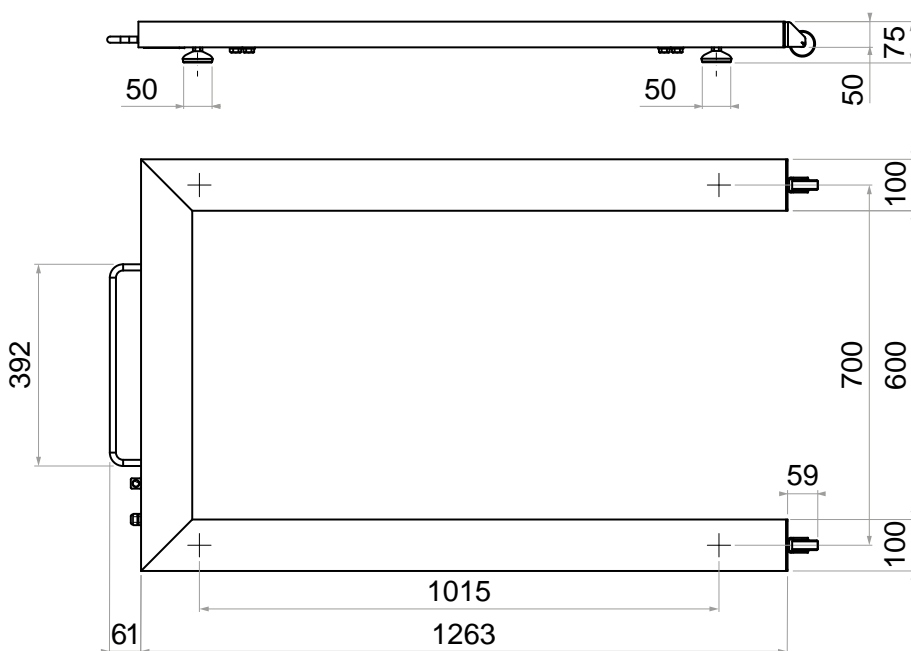





# MAIN OPTIONS **AND ACCESSORIES LIST**

## Calibration Service

	EPWL	EPWLI	Description	Code	
<b>ISO 17025 CALIBRATION CERTIFICATE</b> (only at time of order)	<input type="radio"/>	<input type="radio"/>	For capacity from 1.501 kg up to 3.000 kg.	<b>CT7</b>	

## Accessories

	EPWL	EPWLI	 Description	Code	
<b>FLOOR COLUMNS</b>	<input type="radio"/>	<input type="radio"/>	 Stainless steel column 450 x 450 mm, h = 917 mm, Ø 38 mm. For the indicators of DINI ARGEO and SCALE HOUSE range.	<b>CSP38I-x</b>	
	<input type="radio"/>	<input type="radio"/>	 Stainless steel column 350 x 350 mm, h = 750 mm. Painted steel base. For the indicators of DINI ARGEO and SCALE HOUSE range.	<b>CSP38D</b>	
<b>BRACKET FOR WALL MOUNTING</b>		<input type="radio"/>	 Stainless steel fixing bracket with adjustable inclination. For weight indicator wall mounting.	<b>STFR-x</b>	

NOTES

---



---



---



---





---

● As standard      ○ Optional



Packaging and Weight (see page 84)



 Installation at time of order.









 Installation at time of order.

 Installation at time of order.

(PRODUCT CODE-x): For the current code version please refer to [www.diniargeo.com](http://www.diniargeo.com)

## Options for Communication

	EPWL	EPWLI		Description	Code	
<b>PC SOFTWARE FOR DATA STORAGE</b>	○	○		PC software to record all weighs in real time. ⚠ Price is intended for one scale only.	<b>SWM</b>	
<b>CONNECTION CABLES</b>	○			USB 1,5 m connection cable for connection to PC.	<b>RSCBUSB-x</b>	

	EPWL	EPWLI		 For EPWL	 For PC	 INDOOR	 OUTDOOR	 PLUG	Code	
<b>BLUETOOTH INTERFACE</b>	○			✓		10	10	AMP	<b>BLTH-x</b>	

NOTES

---



---



---



---





---

● As standard    ○ Optional



Packaging and Weight (see page 84)





 Installation at time of order.

 Installation at time of order.

 Installation at time of order.

(PRODUCT CODE-x): For the current code version please refer to [www.diniargeo.com](http://www.diniargeo.com)

## International Power Cables and Sockets

	EPWL	EPWLI		Description	Code	
<b>UK VERSION</b>	●	○		Version with UK plug.	<b>PWCORDUK</b>	
<b>AU VERSION</b>		○		Version with AU plug for EPWLI.	<b>PWCORDAUS</b>	
<b>US VERSION</b>	●	○		Version with US plug.	<b>PWCORDUS</b>	

NOTES

---



---



---



---





---

● As standard      ○ Optional



Packaging and Weight (see page 84)

 Installation at time of order.

 Installation at time of order.

 Installation at time of order.

(PRODUCT CODE-x): For the current code version please refer to [www.diniargeo.com](http://www.diniargeo.com)



## WEIGHING KITS FOR FORKLIFTS AND ELECTRIC PALLET TRUCKS

“

Turn your forklift and electric pallet truck into a mobile scale by installing our dedicated solutions.

”

# WEIGHING KITS FOR FORKLIFTS AND ELECTRIC PALLET TRUCKS



## WEIGHT INDICATORS

Ideal to read the weight directly in the operator cabin.



## LTP

Easy to install and connect to the hydraulic system for overload control and rough weighing.

## TWIN FORKS

Weighing forks with wireless technology, ideal for accurate and approved weighing.



## LTW

Robust and sturdy weighing module, suitable for heavy duty use.

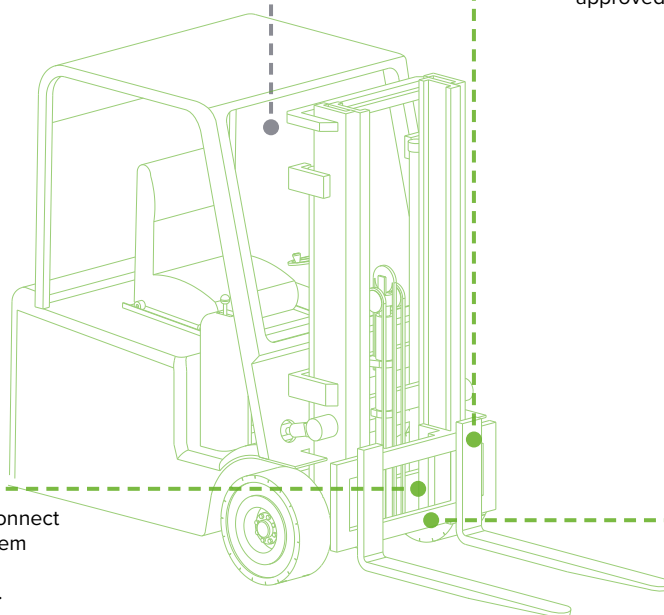

## HYDRAULIC PRESSURE SENSOR

## WEIGHT INDICATOR



## ELP

HYDRAULIC WEIGHING SYSTEM FOR ELECTRIC STACKERS OR ELECTRIC PALLET TRUCKS

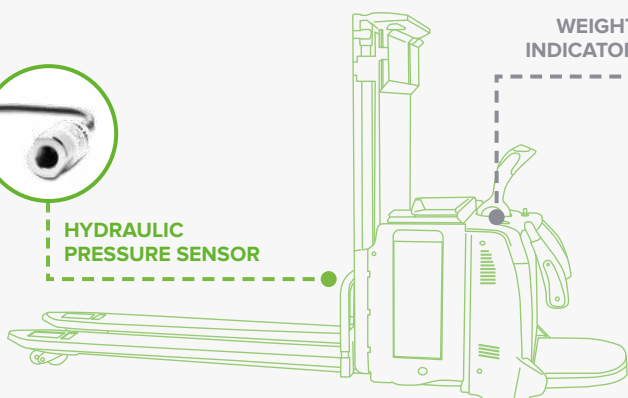



Hydraulic weighing system easy to install on stackers or electric pallet trucks for overload prevention and rough weighing of the handled material. It allows you to weigh the handled material directly on the spot, thus saving time and reducing the traffic in the warehouse.

Choose it because:

- It does not require any mechanical modification
- It does not affect the original manufacturer certification
- It is not subject to accidental impacts

### Main Functions

- ACOUSTIC AND VISUAL INDICATION OF OVERLOADS
- TARE
- PRESET TARE

### Version codes

Max. Capacity (kg)	d (kg)*	Product Code
Up to 4.000 PSI / 280 BAR	from 1 kg	ELP-x

(\*) This value can be influenced by several factors, please refer to the manual for more information.

>> Discover the full range of options and accessories from page 66





## Main Features

Weight measurement		Specific algorithm for stackers and electric pallet trucks
Display		25 mm LCD backlit display
IP protection rating	Sensor	IP65
	Indicator	IP68
Cable length		6 m, shielded connection cable
Cable protection sheathing		3 m, as standard
Hydraulic connection		1/4" parallel BSP
Accuracy		From +/- 0,5% to +/- 5% of capacity, min. 20 kg*
Keyboard		5-key waterproof
Max. barycentric shifting		No influence
Sensor		Nickel-plated steel, with quick connector
Power supply		5 V, via DC/DC converter (see options)
Operating temperature range		-10 / +50 °C
Communication to external devices		Optional Bluetooth and communication port for optional printer

(\* This value can be influenced by several factors, please refer to the manual for more information.

## Certifications

- 2014/30/EU (EMC)
- 2014/35/EU (LVD)
- 2011/65/EU (RoHS)

## Technical Drawing | COMPACT Weight Indicator (mm)

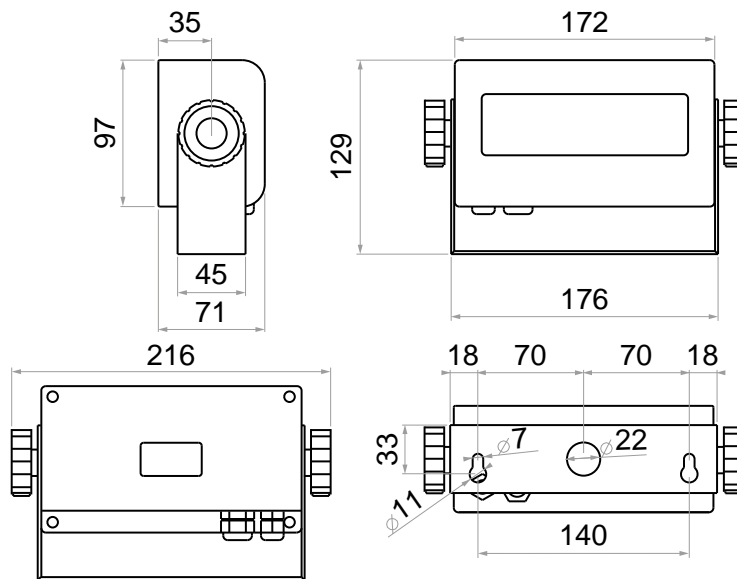

## Technical Drawing | Weight Sensor (mm)

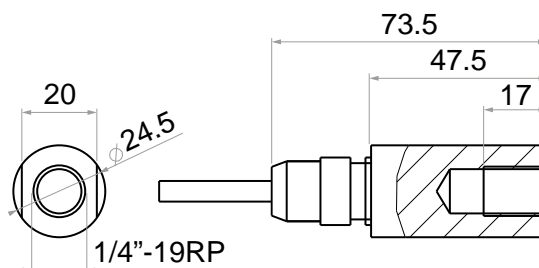



Hydraulic weighing system easy to install on the forklift for overload prevention and rough weighing of the handled material.

It allows you to weigh the handled material directly on the spot, thus saving time and reducing the traffic in the warehouse.

Choose it because:

- It does not reduce the load capacity
- It does not affect the original manufacturer certification
- It is not subject to accidental impacts

### Main Functions

- ACOUSTIC AND VISUAL INDICATION OF OVERLOADS
- TARE
- PRESET TARE



LTP TOOL: Software for weighing system configuration.

### Version codes

Max. Capacity (kg)	d (kg)*	Product Code
Up to 4.000 PSI / 280 BAR	from 5 kg	LTP-x

(\*) This value can be influenced by several factors, please refer to the manual for more information.

(\*\*) Configuration program included in the price.

>> Discover the full range of options and accessories from page 66



Packaging and Weight (see page 84)

## Main Features

Weight measurement	Specific algorithm for forklifts	
Display	25 mm LCD backlit display	
IP protection rating	Sensor	IP65
	Indicator	IP68
Cable length	6 m, shielded connection cable	
Cable protection sheathing	3 m, as standard	
Hydraulic connection	1/4" parallel BSP	
Fixing bracket	As standard	
Accuracy	From +/- 0,5% to +/- 5% of capacity, min. 20 kg*	
Keyboard	5-key waterproof	
Max. barycentric shifting	No influence	
Sensor	Nickel-plated steel, with quick connector	
Power supply	5 to 12 V, via DC/DC converter (see options)	
Operating temperature range	-10 / +50 °C	
Communication to external devices	Optional Bluetooth and communication port for optional printer	

(\* This value can be influenced by several factors, please refer to the manual for more information.

## Certifications

- 2014/30/EU (EMC)
- 2014/35/EU (LVD)
- 2011/65/EU (RoHS)

## Technical Drawing | COMPACT Weight Indicator (mm)

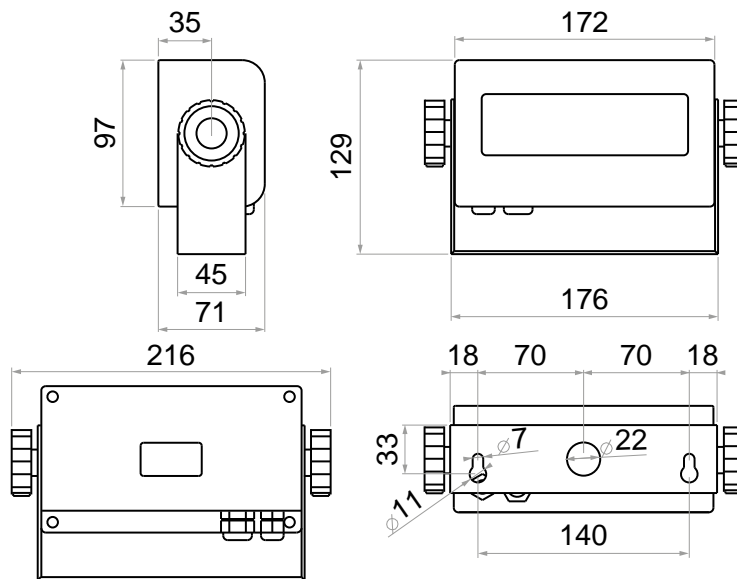

## Technical Drawing | Weight Sensor (mm)

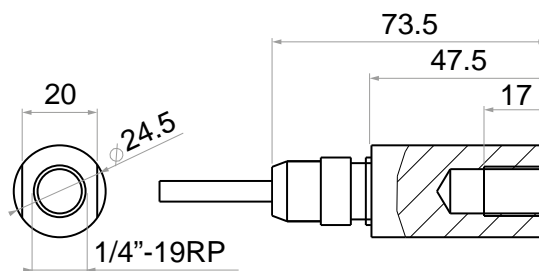

# TWIN FORKS COMPACT

WEIGHING FORKS

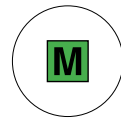

MANUFACTURED IN ITALY



TWIN FORKS represent the easiest weighing solution for forklifts: they simply replace the standard forks transforming your forklift into an accurate approved mobile weighing station. Bluetooth connection, lithium battery and cutting-edge technology to guarantee the best performance. COMPACT indicator as standard.

Choose it because:

- Easy to mount and remove
- Very thin shape with minimum reduction of the lifting capacity
- Approved for legal-for-trade use

## Main Functions | COMPACT INDICATOR

- **WEIGHT TOTALISATION**
- **UNIT CONVERTER:** kg/lb, free conversion factor
- **ZEROING**
- **TARE**
- **PRESET TARE**

## Version codes

M	Printer	Max. Capacity (kg)	d (kg)	e (kg)	Piastra	Product Code
		1.000 - 2.500	1-2		FEM2A	LTF2500C-x
		1.000 - 2.500 - 5.000	2-5-10		FEM2A	LTF5000C-x

## Main Options

### SPECIAL CALIBRATIONS

M	Max. Capacity (kg)	d (kg)	e (kg)	Piastra	Option Code
M	1.000 - 2.500		2-5	FEM2A	ECCEMLTF
M	1.000 - 2.500 - 5.000		5-10	FEM2A	ECCEMLTF
	<i>Special Capacities / Resolutions: upon request.</i>				-

### SPECIAL MODELS

Version for FEM2B fork-holder plate.		<b>FEM2B</b>
Version for FEM3A fork-holder plate (up to 5.000 kg).		-
<i>Other Special Models upon request.</i>		-

>> Discover the full range of options and accessories from page 66



Packaging and Weight (see page 84)

M Legal for trade

Printer Integrated Printer and Date & Time

(PRODUCT CODE-x): For the current code version please refer to [www.dinargeo.com](http://www.dinargeo.com)

## Main Features

Display	25 mm LCD backlit display	
Brightness	Adjustable brightness	
IP protection rating	Forks	IP66
	Indicator	IP67
Fixing bracket	As standard	
Accuracy	Internal use	± 2 kg
	Legal for trade 	In accordance with Directive 2014/31/EU
Keyboard	5 keys waterproof	
Fork structure	Sturdy painted steel	
Fork connection	FEM2A *(FEM2B and FEM3A upon request)	
Max. horizontal inclination	± 2° (for legal for trade use only)	
Max. barycentric shifting	25 mm	
Load cells	4, in stainless steel, with IP68 protection	
Max. allowable overload	More than 300% F.S.	
Auto switch-off	5 min, programmable	
Switch-on	Automatic switch-on function, thanks to the movement detector	
Power supply	Forks	Rechargeable lithium battery with Instaplug technology with EU, UK, AU, US power plugs
	Indicator	5 V, from forklift truck
Operating time	Up to 90 h or 24/7 continuous use with optional battery kit	
Operating temperature range	-10 / +40 °C	
Forks communication	Bluetooth technology	
Communication to external devices	Communication port for optional printer	

## Certifications

- 2014/30/EU (EMC)
- 2014/35/EU (LVD)
- 2011/65/EU (RoHS)
- 2014/31/EU (NAWI)

## Technical Drawing (mm)

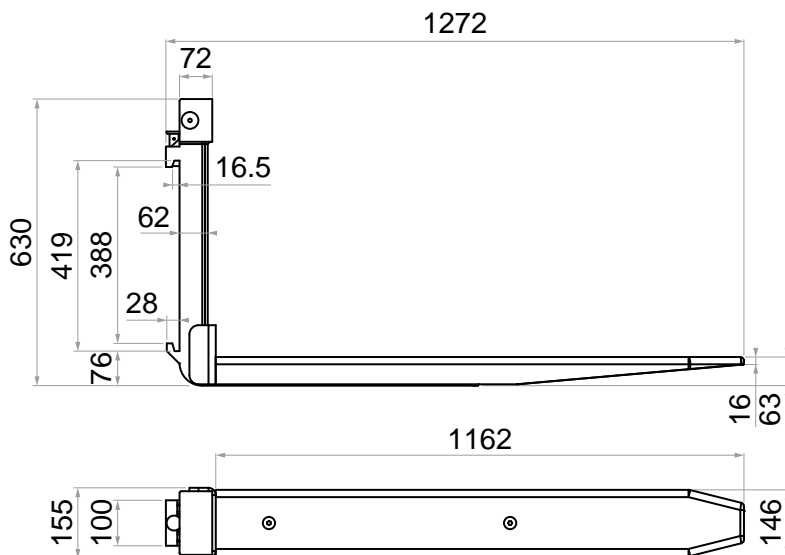

## COMPACT Weight Indicator

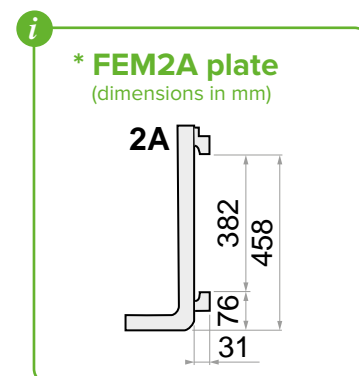
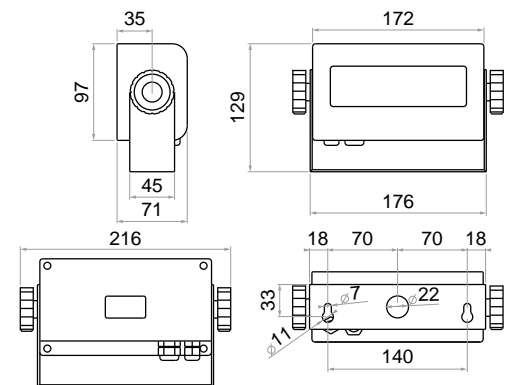

# TWIN FORKS TOUCH SCREEN

## WEIGHING FORKS

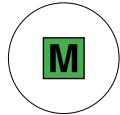

MANUFACTURED IN ITALY



TWIN FORKS represent the easiest weighing solution for forklifts: they simply replace the standard forks transforming your forklift into an accurate approved mobile weighing station. Bluetooth connection, lithium battery and cutting-edge technology to guarantee the best performance. Fitted with TOUCH SCREEN indicator ideal for communication with the computer systems.

Choose it because:

- Easy to mount and remove
- Very thin shape with minimum reduction of the lifting capacity
- Approved for legal-for-trade use

### Main Functions | TOUCH SCREEN INDICATOR

- **DATABASE MANAGEMENT:** Products, Customers, Suppliers and Tares
- **FULL PROGRAMMABILITY**
- **15 PROGRAMMABLE TEXTS**
- **DATA TRANSFER TO MANAGEMENT SYSTEMS**
- **FISCAL MEMORY**
- **APPLICATION PROGRAM FOR:** Totalisation, Piece Counting, Dosage
- **NUMERIC IDs**
- **TARE**
- **PRESET TARE**
- **ZEROING**

### Version codes

M	Printer	Max. Capacity (kg)	d (kg)	e (kg)	Plate	Product Code
		1.000 - 2.500	1-2		FEM2A	LTF2500TS-x
		1.000 - 2.500 - 5.000	2-5-10		FEM2A	LTF5000TS-x

### Main Options

#### SPECIAL CALIBRATIONS

M	Max. Capacity (kg)	d (kg)	e (kg)	Plate	Option Code
M	1.000 - 2.500		2-5	FEM2A	ECEMLTF
M	1.000 - 2.500 - 5.000		5-10	FEM2A	ECEMLTF
	Special Capacities / Resolutions: upon request.				-

#### SPECIAL MODELS

Version for FEM2B fork-holder plate.	FEM2B
Version for FEM3A fork-holder plate (up to 5.000 kg).	-
Other Special Models upon request.	-

>> Discover the full range of options and accessories from page 66



Packaging and Weight (see page 84)

M Legal for trade

Printer Integrated Printer and Date & Time

(PRODUCT CODE-x): For the current code version please refer to [www.dinargeo.com](http://www.dinargeo.com)

## Main Features

Display	5.7" backlit colour touch screen. Resistive technology	
IP protection rating	Forks	IP66
	Indicator	IP65
Fixing bracket	As standard	
Accuracy	Internal use	± 2 kg
	Legal for trade 	In accordance with Directive 2014/31/EU
Keyboard	Touch screen	
Fork structure	Sturdy painted steel	
Fork connection	FEM2A *(FEM2B and FEM3A upon request)	
Max. horizontal inclination	± 2° (for legal for trade use only)	
Max. barycentric shifting	25 mm	
Load cells	4, in stainless steel, with IP68 protection	
Max. allowable overload	More than 300% F.S.	
Switch-on	Automatic switch-on function, thanks to the movement detector	
Power supply	Forks	Rechargeable lithium battery with Instaplug technology with EU, UK, AU, US power plugs
	Indicator	12 V, from forklift truck
Operating time	Up to 90 h or 24/7 continuous use with optional battery kit	
Operating temperature range	-10 / +40 °C	
Forks communication	Bluetooth technology	
Communication to external devices	Communication port for optional printer	

## Certifications

- 2014/30/EU (EMC)
- 2011/65/EU (RoHS)
- 2014/35/EU (LVD)
- 2014/31/EU (NAWI)

## Technical Drawing (mm)

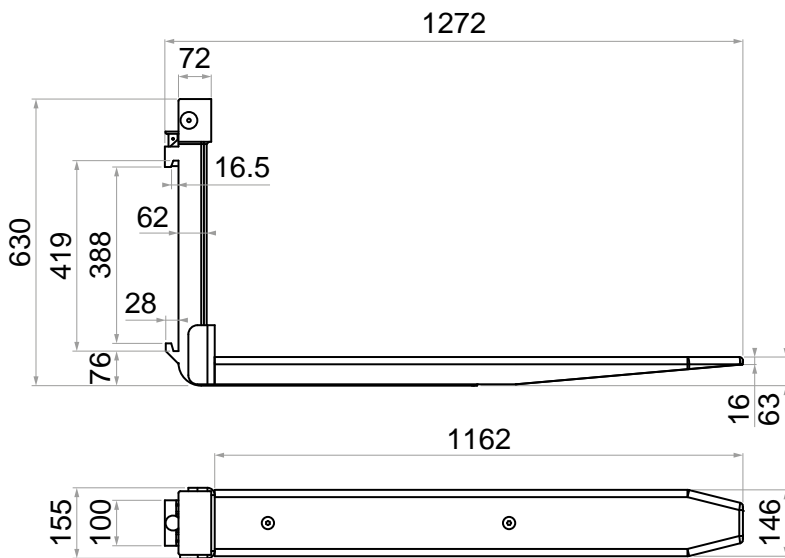

## TOUCH SCREEN Weight Indicator

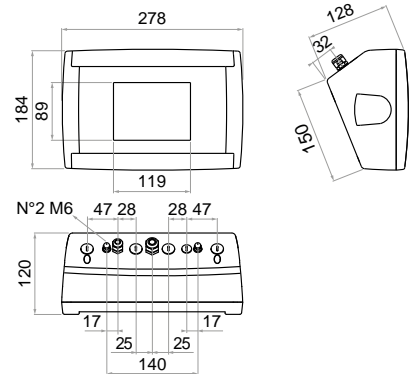

**\* FEM2A plate**  
(dimensions in mm)

# LTW COMPACT FORKLIFT SCALE

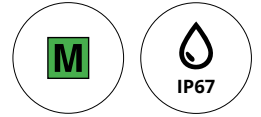

MANUFACTURED IN ITALY

LTW fork-holder plate is added to the existing plates to integrate weighing in a permanent manner while maintaining the possibility of using forks of different lengths depending on the load to be handled. COMPACT indicator for easy installation in the cabin.

Choose it because:

- Suitable for both FEM2A and FEM2B standard forks
- Approved for legal-for-trade use
- Available in wired or wireless version



## Main Functions | COMPACT INDICATOR

- WEIGHT TOTALISATION
- PIECE COUNTING
- UNIT CONVERTER: kg/lb, free conversion factor
- ZEROING
- TARE
- PRESET TARE

## Version codes

M	Printer	Connection	Max. Capacity (kg)	d (kg)	e (kg) M	Product Code
		Wired	600 - 1.500	0,2 - 0,5		LTWC15-x
		Wired	1.500 - 2.500	0,5 - 1		LTWC25-x
		Bluetooth	600 - 1.500	0,2 - 0,5		LTWC15BTH-x
		Bluetooth	1.500 - 2.500	0,5 - 1		LTWC25BTH-x

## Main Options

### SPECIAL CALIBRATIONS

M	Max. Capacity (kg)	d (kg)	e (kg) M	Option Code
M	600 - 1.500		1 - 2	ECMLTW
M	1.500 - 2.500		2 - 5	ECMLTW
	<i>Special Capacities / Resolutions: upon request.</i>			-

### SPECIAL MODELS

<i>Other Special Models upon request.</i>	-
---	---

>> Discover the full range of options and accessories from page 66



Packaging and Weight (see page 84)

M Legal for trade

Printer Integrated Printer and Date & Time

(PRODUCT CODE-x): For the current code version please refer to [www.diniargeo.com](http://www.diniargeo.com)



## Main Features

Display	25 mm LCD backlit display	
Brightness	Adjustable brightness	
IP protection rating	Plate	IP67
	Indicator	IP68
Cable length	5 m, extendible, as standard (only for wired version)	
Fixing bracket	As standard	
Accuracy	Internal use	± 0,05% of the max. capacity
	Legal for trade 	In accordance with Directive 2014/31/EU
Keyboard	5 keys waterproof	
Structure	Bearing structure in extra thick sheet steel. Hermetically sealed junction box	
Plate dimensions	<b>Standard FEM class II* - 910 x 407 x 110 mm</b>	
Max. horizontal inclination	± 2° (for legal for trade use only)	
Max. barycentric shifting	55 mm	
Load cells	2, in stainless steel, with IP68 protection	
Max. safe overload	More than 300% F.S., with protection nut in case of broken hinges	
Auto switch-off	5 min, programmable	
Power supply	5 V, from the forklift	
Operating temperature range	-10 / +40 °C	
Bluetooth version	Includes Bluetooth emitter integrated on the fork-holder plate with rechargeable battery. Working time: 40 h. Supplied with battery recharger with EU plug.	
Communication to external devices	Wired version	Optional radio-frequency. Wi-Fi or Bluetooth and communication port for optional printer
	Bluetooth version	Communication port for optional printer
Fiscal memory	Optional	
Date and time	Optional	

## Certifications

- 2014/30/EU (EMC)
- 2014/35/EU (LVD)
- 2011/65/EU (RoHS)
- 2014/31/EU (NAWI)

## Technical Drawing (mm)

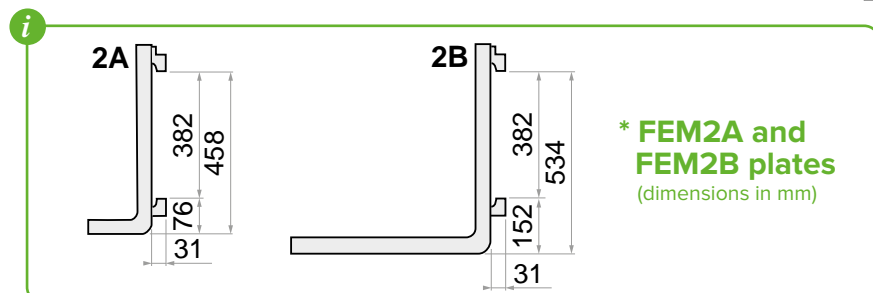
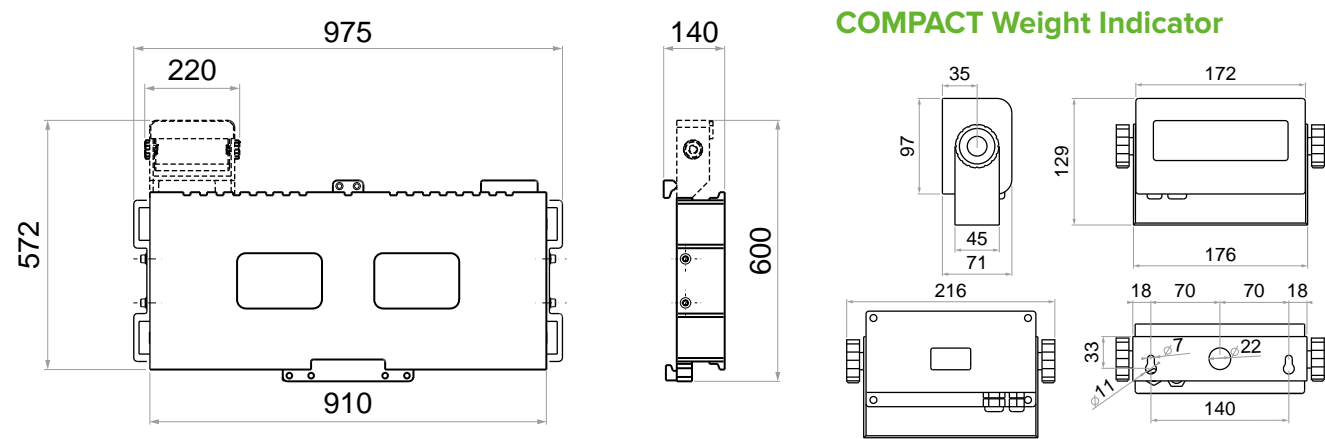

# LTW TOUCH SCREEN FORKLIFT SCALE



MANUFACTURED IN ITALY

Accurate weighing module for fixed applications and designed to be matched with any type of forks. Fitted with TOUCH SCREEN indicator ideal for communication with the computer systems.

Choose it because:

- Suitable for both FEM2A and FEM2B standard forks
- Approved for legal-for-trade use
- Available in wired or wireless version



## Main Functions | TOUCH SCREEN INDICATOR

- **GESTIONE DATABASE:** Prodotti, Clienti, Fornitori e Tare
- **COMPLETAMENTE PERSONALIZZABILE**
- **15 TESTI PROGRAMMABILI**
- **TRASFERIMENTO DATI**
- **MEMORIA FISCALE**
- **PROGRAMMA APPLICATIVO PER:** Totalizzazione, Contapezzi, Dosaggio
- **ID NUMERICI**
- **TARA**
- **TARA PREIMPOSTATA**
- **AZZERAMENTO**

## Version codes

		Connection	Max. Capacity (kg)	d (kg)	e (kg)	Product Code
		Wired	600 - 1.500	0,2 - 0,5		LTWTS15-x
		Wired	1.500 - 2.500	0,5 - 1		LTWTS25-x
		Bluetooth	600 - 1.500	0,2 - 0,5		LTWTS15BTH-x
		Bluetooth	1.500 - 2.500	0,5 - 1		LTWTS25BTH-x

## Main Options

### SPECIAL CALIBRATIONS

	Max. Capacity (kg)	d (kg)	e (kg)	Option Code
	600 - 1.500		1 - 2	ECMLTW
	1.500 - 2.500		2 - 5	ECMLTW
	Special Capacities / Resolutions: upon request.			-

### SPECIAL MODELS

Other Special Models upon request.	-
------------------------------------	---

>> Discover the full range of options and accessories from page 66



Packaging and Weight (see page 84)

Legal for trade

Integrated Printer and Date & Time

(PRODUCT CODE-x): For the current code version please refer to [www.dinargeo.com](http://www.dinargeo.com)

## Main Features

Display	5.7" backlit colour touch screen. Resistive technology	
IP protection rating	Plate	IP67
	Indicator	IP65
Cable length	5 m, extendible, as standard (only for wired version)	
Fixing bracket	As standard	
Accuracy	Internal use	± 0,05% of the max. capacity
	Legal for trade 	In accordance with Directive 2014/31/EU
Keyboard	Touch screen	
Structure	Bearing structure in extra thick sheet steel. Hermetically sealed junction box	
Plate dimensions	<b>Standard FEM class II* - 910 x 407 x 110 mm</b>	
Max. horizontal inclination	± 2° (for legal for trade use only)	
Max. barycentric shifting	55 mm	
Load cells	2, in stainless steel, with IP68 protection	
Max. allowable overload	More than 300% F.S, with protection nut in case of broken hinges	
Power supply	12 V, from the forklift	
Operating temperature range	-10 / +40 °C	
Bluetooth version	Includes Bluetooth emitter integrated on the fork-holder plate with rechargeable battery. Working time: 60 h. Supplied with battery recharger with EU plug.	
Communication to external devices	Wired version	Optional radio-frequency, Wi-Fi or Bluetooth and communication port for optional printer
	Bluetooth version	Communication port for optional printer
Fiscal memory	As standard	
Date and time	As standard	
Database	1.000 articles, 300 tares, 200 customers	
Programmability	Free memory spaces for customised application program	
Free alphanumeric texts	15	

## Certifications





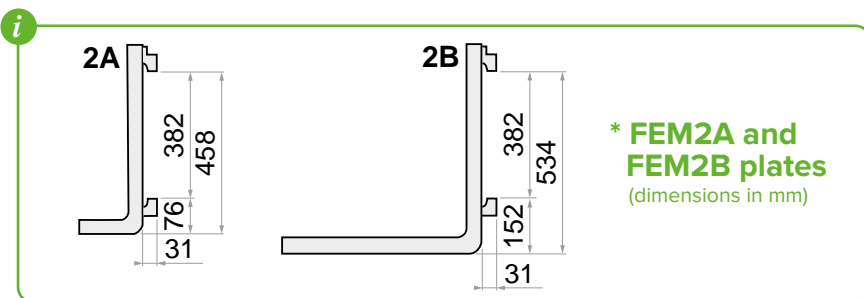
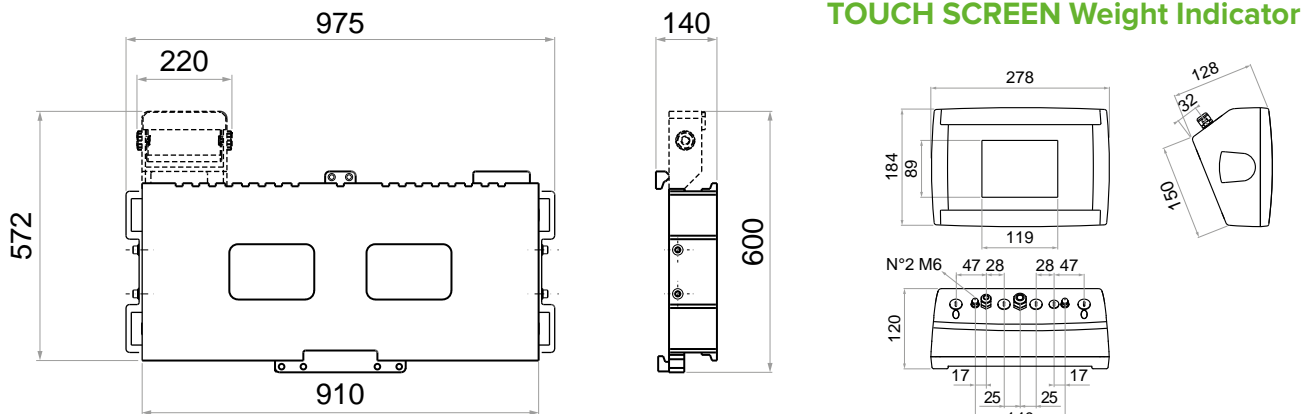



- 2014/30/EU (EMC)
- 2014/35/EU (LVD)
- 2011/65/EU (RoHS)
- 2014/31/EU (NAWI)















## Technical Drawing (mm)



# MAIN OPTIONS **AND ACCESSORIES LIST**

## Options for Communication

	ELP	LTP	TWIN FORKS COMPACT	TWIN FORKS TOUCH SCREEN	LTV COMPACT	LTV TOUCH SCREEN		Description	Code	
<b>STORING THE WEIGHS</b> (only at time of order)				<input type="radio"/>		<input type="radio"/>		Built-in USB port to store data on a USB driver. To be combined with touch screen versions. Fitted with USB key for PC.	<b>USBEGT</b>	
				<input type="radio"/>		<input type="radio"/>		PC program to record all weighs in real time. ⚠ Price is intended for one scale only.	<b>SWM</b>	
<b>FISCAL MEMORY</b> 			<input checked="" type="radio"/>		<input type="radio"/>	<input type="radio"/>		Alibi memory (fiscal memory, max. 120.000 weighs) with integrated real time clock.	<b>ALMEM-x</b>	
<b>BARCODE READER</b>				<input type="radio"/>		<input type="radio"/>		Pocket Bluetooth scanner for barcodes. Equipped with USB cable for recharge.	<b>SCBTH</b>	

	ELP	LTP	TWIN FORKS COMPACT	TWIN FORKS TOUCH SCREEN	LTV COMPACT	LTV TOUCH SCREEN		 For FORK LIFT	 For PC	 INDOOR	 OUTDOOR	 PLUG	Code	
<b>RADIO 2.4 GHZ EMITTER</b>						<input type="radio"/>		<input checked="" type="checkbox"/>		70	150	AMP	<b>OBRF2G4</b>	
<b>RADIO 2.4 GHZ RECEIVER</b>						<input type="radio"/>			<input checked="" type="checkbox"/>	70	150	USB	<b>OBRF2G4-USB</b>	
<b>Wi-Fi</b>				<input type="radio"/>		<input type="radio"/>		<input checked="" type="checkbox"/>		70	70	AMP	<b>WIFITD-x</b>	
<b>BLUETOOTH INTERFACE</b>						<input type="radio"/>		<input checked="" type="checkbox"/>		10	10	AMP	<b>BLTH-x</b>	
<b>PC INTERFACE</b>	<input type="radio"/>	<input type="radio"/>							<input checked="" type="checkbox"/>			USB	<b>RSCBUSBLTP</b>	

● As standard      ○ Optional



Packaging and Weight (see page 84)







 Installation at time of order.

 Installation at time of order.

 Installation at time of order.



(PRODUCT CODE-x): For the current code version please refer to [www.diniargeo.com](http://www.diniargeo.com)

## Printers and Expandable Materials

	ELP	LTP	TWIN FORKS COMPACT	TWIN FORKS TOUCH SCREEN	LTW COMPACT	LTW TOUCH SCREEN		Description	Code	
<b>PRINTERS</b>	<input type="radio"/>	<input type="radio"/>	<input type="radio"/>	<input type="radio"/>	<input type="radio"/>	<input type="radio"/>		Thermal printer powered from the indicator. Thermal paper roll included as standard. Needs 5V ALxxxV5 power supply..	<b>OBTPRLT-x</b>	
<b>CUSTOMISATION SERVICES</b>						<input type="radio"/>		Custom-made ticket (up to 4 layouts).	<b>PRNSERV</b>	
<b>EXPANDABLE MATERIALS</b>	<input type="radio"/>	<input type="radio"/>	<input type="radio"/>	<input type="radio"/>	<input type="radio"/>	<input type="radio"/>		50 thermal paper rolls 30 m long, 57 mm wide.	<b>RPT57C</b>	
	<input type="radio"/>	<input type="radio"/>	<input type="radio"/>	<input type="radio"/>	<input type="radio"/>	<input type="radio"/>		50 adhesive thermal paper rolls 15 m long, 57 mm wide.	<b>RPT57AC</b>	
	<input type="radio"/>	<input type="radio"/>	<input type="radio"/>	<input type="radio"/>	<input type="radio"/>	<input type="radio"/>	 Adhesive	72 rolls of Linerless thermal sticker paper 21 m long, 55 mm wide.	<b>LNLESS</b>	

(\*) NET PRICE



## Accessories

	ELP	LTP	TWIN FORKS COMPACT	TWIN FORKS TOUCH SCREEN	LTW COMPACT	LTW TOUCH SCREEN		Description	Code	
<b>FIXING BRACKET FOR INDICATOR</b>			<input type="radio"/>			<input type="radio"/>		Additional fixing bracket for indicator, specific for forklift cabin.	<b>STFL</b>	
	<input type="radio"/>	<input type="radio"/>	<input type="radio"/>		<input type="radio"/>			Jointed bracket for fixing the weight indicator in cabin, for LTW Compact, TWIN FORKS, LTP and ELP.	<b>STFLC</b>	
				<input type="radio"/>		<input type="radio"/>		Jointed for fixing the weight indicator in cabin, for LTW Touch Screen.	<b>STFLTS</b>	















● As standard    ○ Optional



Packaging and Weight (see page 84)

 Installation at time of order. Installation at time of order. Installation at time of order.(PRODUCT CODE-x): For the current code version please refer to [www.diniargeo.com](http://www.diniargeo.com)

## Batteries and Battery Chargers

	ELP	LTP	TWIN FORKS COMPACT	TWIN FORKS TOUCH SCREEN	LTW COMPACT	LTW TOUCH SCREEN		Description	Code	
<b>POWER SUPPLY UNIT</b>				<input type="radio"/>		<input type="radio"/>		Power adapter* for the indicator in the cabin (mounting not included). From 9 to 18 Vdc input (directly from the forklift), 12 Vdc 2,5A output for the indicator (max. 30 W).	AL918V12	
				<input type="radio"/>		<input type="radio"/>		Power adapter* for the indicator in the cabin (mounting not included). From 18 to 72 Vdc input (directly from the forklift), 12 Vdc 2,5 A output for the indicator (max. 30 W).	AL1872V12	
				<input type="radio"/>		<input type="radio"/>		Power adapter* for the indicator in the cabin (mounting not included). From 40 to 160 Vdc input (directly from the forklift), 12 Vdc 2,5 A output for the indicator (max. 30 W).	AL40160V12	
	<input type="radio"/>	<input type="radio"/>	<input type="radio"/>		<input type="radio"/>			Power adapter for the "COMPACT" indicator and thermal printer in cabin (mounting not included). From 40 to 160 Vdc input (directly from the lift truck), 5Vdc 6A output (max 30W).	AL40160V5	
	<input type="radio"/>	<input type="radio"/>	<input type="radio"/>		<input type="radio"/>			Power adapter for the "COMPACT" indicator and thermal printer in cabin (mounting not included). From 18 to 72 Vdc input (directly from the lift truck), 5Vdc 6A output (max 30W).	AL1872V5	
	<input type="radio"/>	<input type="radio"/>	<input type="radio"/>		<input type="radio"/>			Power adapter for the "COMPACT" indicator and thermal printer in cabin (mounting not included). From 9 to 18 Vdc input (directly from the lift truck), 5 Vdc 6A output (max 30W).	AL918V5	
<b>ADDITIONAL REMOVABLE BATTERY</b>			<input type="radio"/>					Kit of two additional lithium batteries with instaplug technology, for 24/7 continuous working.	INSTAPLUGLKC	

## Calibration Service

	ELP	LTP	TWIN FORKS COMPACT	TWIN FORKS TOUCH SCREEN	LTW COMPACT	LTW TOUCH SCREEN	Description	Code
<b>ISO 17025 CALIBRATION CERTIFICATE</b> (only at time of order)					<input type="radio"/>	<input type="radio"/>	For capacity from 301 kg up to 1.500 kg.	CT6
			<input type="radio"/>	<input type="radio"/>	<input type="radio"/>	<input type="radio"/>	For capacity from 1.501 kg up to 3.000 kg.	CT7
			<input type="radio"/>	<input type="radio"/>			For capacity from 3.001 kg up to 6.000 kg.	CT8

● As standard      ○ Optional



Packaging and Weight (see page 84)

 Installation at time of order.

 Installation at time of order.

 Installation at time of order.

(PRODUCT CODE-x): For the current code version please refer to [www.diniargeo.com](http://www.diniargeo.com)

## DIMENSIONING SYSTEMS

“

Integrate dimensioning systems in your warehouse to control packages and palletised goods.

”



# DIMENSIONING SYSTEMS



# IDIMENSION® PLUS

## PARCEL DIMENSIONING SYSTEM

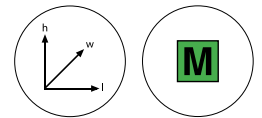

**RICE LAKE**  
WEIGHING SYSTEMS

The Rice Lake Weighing Systems branded dimensioning system is designed to quickly and accurately measure the volume of parcels, envelopes and objects handled by hand, sharing data with the company's computer system in real time.

Choose it because:

- Ideal for speeding up the workflow in intralogistics processes
- Quick and easy installation
- Approved for-legal-for-trade use

### Main functions

- OBJECT DIMENSIONING
- DATA TRANSMISSION
- CAMERA

### Version codes

M	Camera	Column (m)	Packages dimension (cm)				e (kg)	Product Code
			l	h	w	d (cm)		
	Standard	1,2	3 - 100	0 - 60	3 - 60	0,5	0,5	<b>204599</b>
	Standard	1,5	3 - 120	0 - 70	3 - 80	0,5	0,5	<b>204596</b>
	4K	1,2	3 - 100	0 - 60	3 - 60	0,5	0,5	<b>204600</b>
	4K	1,5	3 - 120	0 - 70	3 - 80	0,5	0,5	<b>204598</b>

### Main Options

#### SPECIAL CALIBRATIONS

M	d (kg)	e (kg)	Option code
M		0,5	<b>ECEM-IDIM</b>
	<i>Special Capacities / Resolutions: upon request.</i>		-

(\*) NET PRICE

#### SPECIAL MODELS

<i>Other Special Models upon request.</i>	-
---	---

>> Discover the full range of options and accessories from page 76



Packaging and Weight (see page 84)

M Legal for trade

Integrated Printer and Date & Time

(PRODUCT CODE-x): For the current code version please refer to [www.diniargeo.com](http://www.diniargeo.com)

## Main Features

Display		7" colour touch screen display
Accuracy	For cartons/boxes	± 5 mm
	For irregular boxes	± 10 mm
Measuring time		0,2 sec.
Detection capability		All opaque packages
I/O ports		USB A port and Ethernet port (Webserver optional)
Integration protocols		API and SDK
Power supply		110-240 Vac with US plug as standard*
Weighing Integration	Dini Argeo weight indicators	DFW and 3590 touch screen
	Dini Argeo connectable platforms	T-Series and TE, PB and PBI
	Rice Lake scales	BenchPro Series
Operating temperature range		0 / +40 °C

(\* EU, UK AU versions: upon request.

## Certifications

- 2014/35/EU – (LVD)
- 2014/30/EU – (EMC)
- 2011/65/EU – (RoHS)

## Technical Drawing (mm)

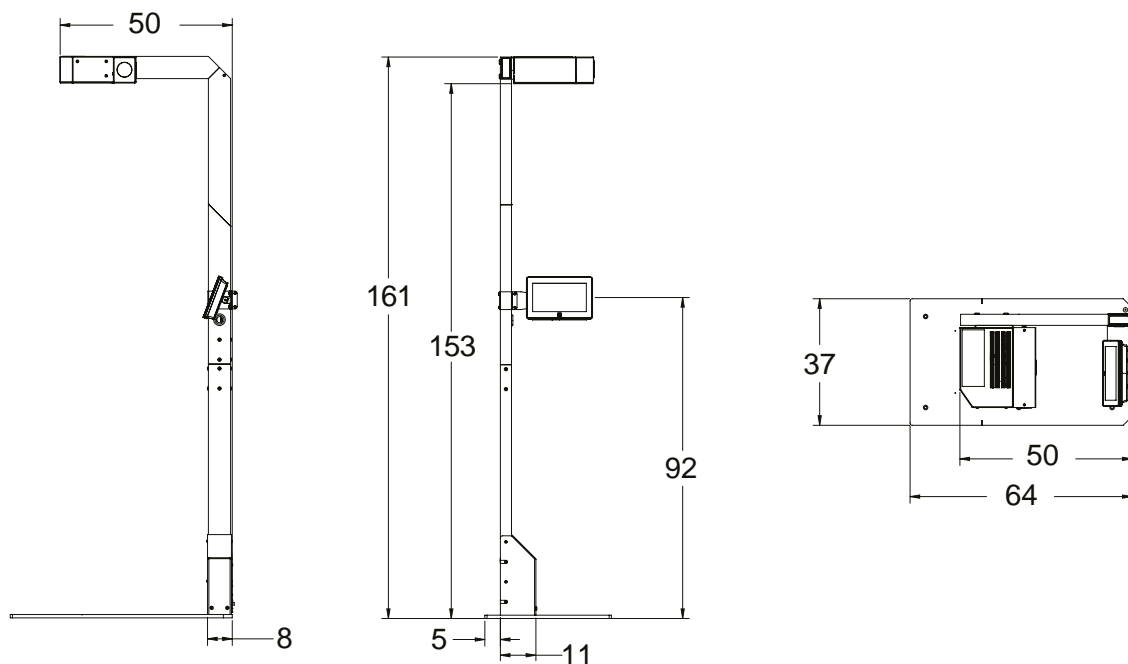

# IDIMENSION® PLUS XL

FOR OEM SOLUTIONS

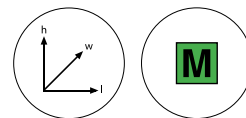

**RICE LAKE**  
WEIGHING SYSTEMS

Modular dimensioning system, consisting of a static dimensioning unit and touch screen indicator, ideal for integrating the weight with the volume reading of parcels, cartons and envelopes in pre-shipment handling and sorting machines or lines, or for input and output control.

Choose it because:

- Ideal for integration into OEM systems
- Possibility of connection to scales, indicators and weighing platforms
- Simple and fast installation

## Main functions

- OBJECT DIMENSIONING
- DATA TRANSMISSION
- OBJECT PHOTO STORAGE

## Version codes

Camera	Dimensioning capacity (l x w x h) (cm)	Resolution (cm)	Product Code
Standard	da 3 x 3 x 0 a 120 x 80 x 80	0,5 / 1	<b>204601</b>
4K	da 3 x 3 x 0 a 120 x 80 x 80	0,5 / 1	<b>204602</b>

## Main Options

SPECIAL MODELS

Other Special Models upon request.	-
------------------------------------	---

>> Discover the full range of options and accessories from page 76



Packaging and Weight (see page 84)

## Main Features

Display		7" colour touch screen display
Accuracy	For cartons/boxes	± 5 mm
	For irregular boxes	± 10 mm
Measuring time		0,2 sec.
Detection capability		All opaque packages
I/O ports		USB A port and Ethernet port (optional Webserver)
Integration protocols		API and SDK
Power supply		110-240 Vac, with US power socket as standard*
Weighing Integration	Dini Argeo weight indicators	DFW and 3590 touch screen Series
	Dini Argeo connectable platforms	T, TE and PB Series
	Rice Lake scales	Serie BenchPro
Temperatura di utilizzo		0 / +40 °C

(\*) EU, UK AU versions: on request.

## Certifications

- 2014/35/EU – (LVD)
- 2014/30/EU – (EMC)
- 2011/65/EU – (RoHS)

## Technical Drawing (mm)

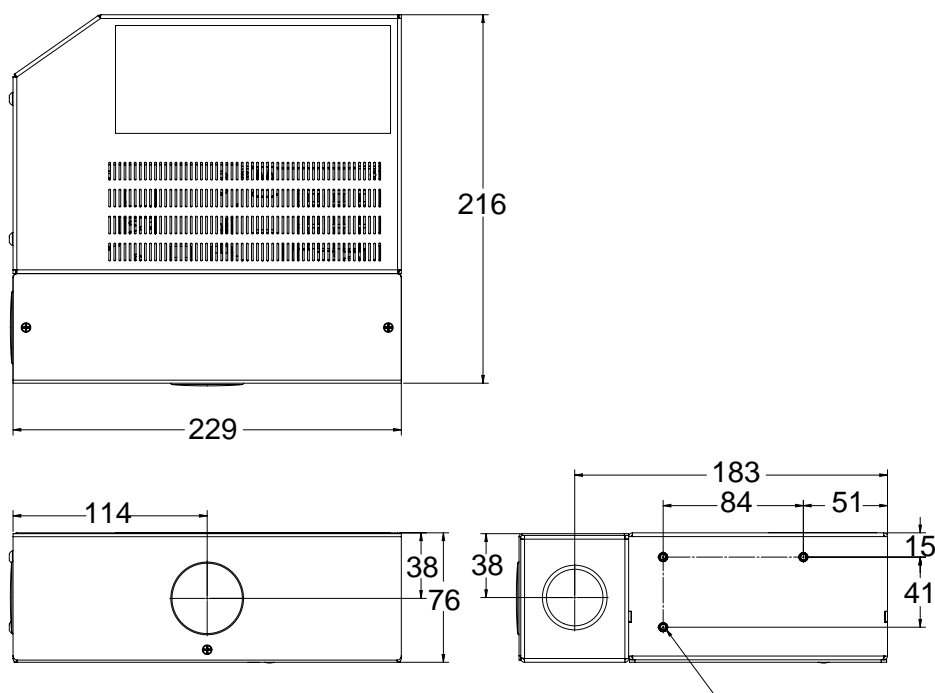

# MAIN OPTIONS **AND ACCESSORIES LIST**

## Options for Communication

	IDIMENSION® PLUS	IDIMENSION® PLUS XL		Description	Code
<b>WEBSERVER</b>	○	○		IDIMENSION® SS Webserver, for archive management and data integration with the company computer system.	<b>175812</b>

## Mounting accessories

	IDIMENSION® PLUS	IDIMENSION® PLUS XL		Description	Code
<b>COLUMN</b>		○		Floor Stand, IDIMENSION®.	<b>174660</b>

NOTES

● As standard      ○ Optional



Packaging and Weight (see page 84)

 Installation at time of order.

 Installation at time of order.

 Installation at time of order.

(PRODUCT CODE-x): For the current code version please refer to [www.diniargeo.com](http://www.diniargeo.com)



# Weighing system for integrated data management with indicator Series 3590

To be combined with Dini Argeo weighing platform

PALLET TRUCK SCALES

PALLET SCALES

WEIGHING KITS FOR FORKLIFTS AND ELECTRIC PALLET TRUCKS

DIMENSIONING SYSTEMS MAIN OPTIONS

	IDIMENSION® PLUS	IDIMENSION® PLUS XL		Description	Code	
<b>WEIGHT INDICATOR</b>	○	○		Touch screen indicator with AF01 software. ABS enclosure. Colour Display.	<b>3590ET</b>	
<b>RS485 INTERFACE</b>	○	○		Built-in RS485 interface (mounting and cable gland excluded).	<b>RS485C</b>	
<b>SOFTWARE</b>	○	○		Program to connect 3590 Touch to IDIMENSION® PLUS.	<b>AF-DIM</b>	
<b>ETHERNET INTERFACE</b>	○	○		Built-in Ethernet interface. Speed from 10 to 100 Mbps, TCP, UDP, IP, ARP, ICMP, Ethernet Mac protocols.	<b>ETHD-x</b>	
<b>CONNECTION CABLE</b>	○	○		Ethernet cable, l=1,5m. Fitted with fairlead, for connection between indicator and PC network.	<b>ETHCBRJ</b>	
<b>LABELLER</b>	○	○		Thermal transfer or direct thermal labelling machine Supplied with standard peel mechanism. Maximum printing size 25400 x 108 mm. Maximum roll Ø 127 mm and width up to 112 mm. Label roll and ribbon not included.	<b>LP542TE</b>	
<b>CONNECTION CABLE</b>	○	○		RS232 cable l=1,5m for LP542xx, SMTPLUS, PR80 printers.	<b>RSCBLP</b>	
<b>CUSTOMISATION SERVICE</b>	○	○		Custom-made label (up to 4 layouts).	<b>APRNSERV</b>	
<b>CONFIGURATION SERVICE</b>	○	○		Service of factory configuration of IDIMENSION® PLUS system connected to Dini Argeo scale.	<b>IDIM-CFG</b>	

(\*) NET PRICE

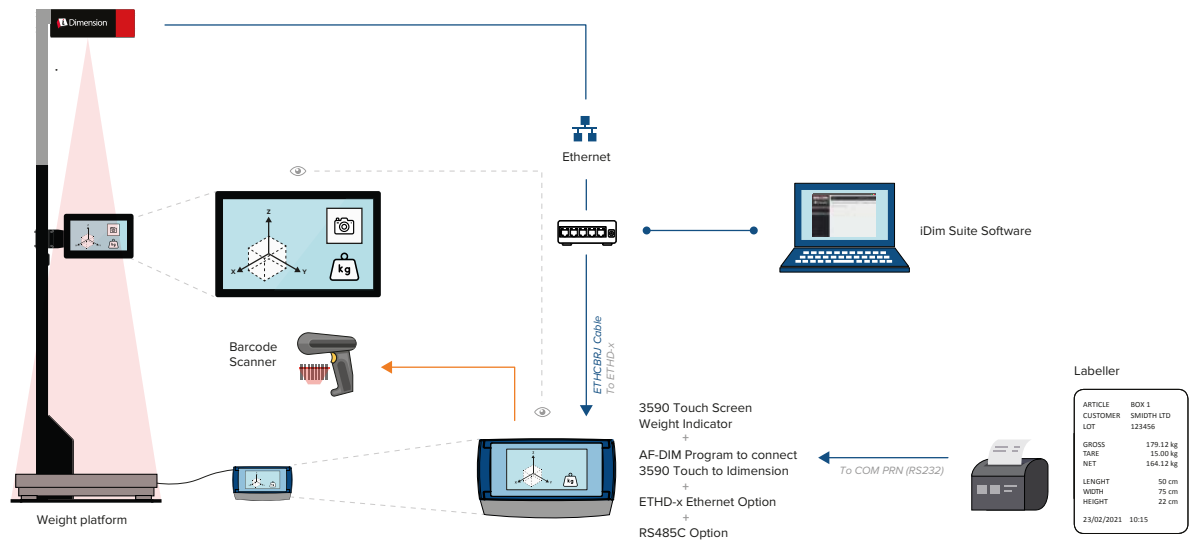

● As standard ○ Optional

Packaging and Weight (see page 84)

Installation at time of order.

Installation at time of order.





Installation at time of order.

(PRODUCT CODE-x): For the current code version please refer to [www.diniargeo.com](http://www.diniargeo.com)



## Weighing system for integrated data management with DFWL series indicator

To be combined with Dini Argeo weighing platform

	IDIMENSION® PLUS	IDIMENSION® PLUS XL		Description	Code	
<b>WEIGHT INDICATOR</b>	<input type="radio"/>	<input type="radio"/>		Weight indicator with ABS case and 5-key keypad. Backlit LCD display and standard weighing program.	<b>DFWL-x</b>	
<b>CONNECTION CABLE</b>	<input type="radio"/>	<input type="radio"/>		USB PC/RS232 converter cable, l=1,5m. USB/RJ11 connector.	<b>RSCBUSB-x</b>	
<b>SCANNER</b>	<input type="radio"/>	<input type="radio"/>		USB hub for simultaneous connection of scale and barcode reader.	<b>USB-HUB</b>	
<b>CONFIGURATION SERVICE</b>	<input type="radio"/>	<input type="radio"/>		Service of factory configuration of IDIMENSION® PLUS system connected to Dini Argeo scale.	<b>IDIM-CFG</b>	

(\*) NET PRICE

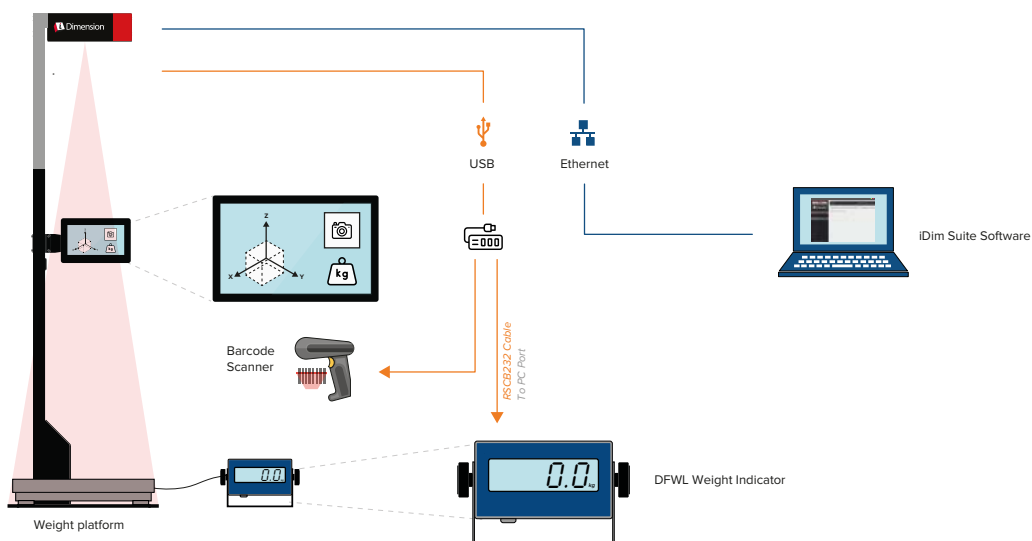

● As standard    ○ Optional

 Packaging and Weight (see page 84)





 Installation at time of order.

 Installation at time of order.

 Installation at time of order.

(PRODUCT CODE-x): For the current code version please refer to [www.diniargeo.com](http://www.diniargeo.com)

## International Power Cables and Sockets

	IDIMENSION® PLUS	IDIMENSION® PLUS XL		Description	Code	
<b>EU VERSION</b>	<input type="radio"/>	<input type="radio"/>		Version with EU power cord.	<b>PWCORDEUVDE</b>	
<b>UK VERSION</b>	<input type="radio"/>	<input type="radio"/>		Version with BS1363 power cord (UK plug).	<b>PWCORDUKVDE</b>	
<b>AU VERSION</b>	<input type="radio"/>	<input type="radio"/>		Version with AU power cord.	<b>PWCORDAUSVDE</b>	

### NOTES

---



---



---



---





---

● As standard      ○ Optional



Packaging and Weight (see page 84)

 Installation at time of order.

 Installation at time of order.

 Installation at time of order.

(PRODUCT CODE-x): For the current code version please refer to [www.diniargeo.com](http://www.diniargeo.com)

 **Connectable Bench Pro platforms (metric approval not available)**

	IDIMENSION® PLUS	IDIMENSION® PLUS XL		Max. load capacity (kg)	Division (g)	Loading surface dimensions (l x w x h) (mm)	Code	
<b>STANDARD LOADING SURFACE</b>	<input type="radio"/>	<input type="radio"/>		75	20	305 x 355 x 69	<b>184585</b>	
	<input type="radio"/>	<input type="radio"/>		75	50	457 x 457 x 109	<b>202191</b>	
	<input type="radio"/>	<input type="radio"/>		15	50	508 x 508 x 109	<b>182396</b>	
	<input type="radio"/>	<input type="radio"/>		15	50	610 x 610 x 109	<b>182400</b>	
<b>LOADING PLATFORM WITH IDLE CONVEYOR</b>	<input type="radio"/>	<input type="radio"/>		75	20	457 x 457 x 165	<b>202190</b>	
	<input type="radio"/>	<input type="radio"/>		15	50	508 x 508 x 165	<b>182398</b>	
	<input type="radio"/>	<input type="radio"/>		15	50	610 x 610 x 165	<b>182402</b>	
<b>LOADING PLATFORM WITH BALL ROLLER</b>	<input type="radio"/>	<input type="radio"/>		75	20	457 x 457 x 123	<b>201730</b>	
	<input type="radio"/>	<input type="radio"/>		15	50	508 x 508 x 123	<b>182401</b>	

NOTES

---



---



---



---



---



---

● As standard      ○ Optional



Packaging and Weight (see page 84)

 Installation at time of order.

 Installation at time of order.

 Installation at time of order.

(PRODUCT CODE-x): For the current code version please refer to [www.diniargeo.com](http://www.diniargeo.com)



## Printing examples

TPWLK, TPWP, TPW TOUCH, TPW "E-FORCE" pallet truck scales, LTP / ELP hydraulic pressure sensors, TWIN FORKS and LTW fork-holder weighing plates can be equipped with an integrated printer.

Languages available for printing:

- Italian
- English
- German
- French
- Spanish
- Chinese (requires printer with Chinese characters)
- Portuguese (only for TPW TOUCH, TWIN FORKS TOUCH SCREEN, LTW TOUCH SCREEN)
- Greek (only for TPW TOUCH, TWIN FORKS TOUCH SCREEN, LTW TOUCH SCREEN)

### Ticket example

MARIO ROSSI SRL VIA DELL'INDUSTRIA, 20 41042 - FIORANO (MO) - ITALY WWW.MARIOROSSI.IT	Heading
WEIGHING NR. 1	Progressive weighing number (for accumulation modes)
GROSS 15.000 kg TARE 3.000 kg NET 12.000 kg	Weight data
TICKET NR. 54321	Progressive ticket number
05/01/2024 15:39:03	Date and time
	Barcode 39

### Packing list example

MARIO ROSSI SRL VIA DELL'INDUSTRIA, 20 41042 - FIORANO (MO) - ITALY WWW.MARIOROSSI.IT	
WEIGHING NR. 00000001 NET 1.000 kg	
WEIGHING NR. 00000002 NET 1.000 kg	
WEIGHING NR. 00000003 NET 1.000 kg	
WEIGHING NR. 00000004 NET 1.000 kg	
WEIGHING TOTAL 00000004 TOTAL NET 4.000 kg TICKET NR. 12345 05/01/23 15:39:03	

### Ticket example

(only for TPW TOUCH, TWIN FORKS TOUCH SCREEN, LTW TOUCH SCREEN)

MARIO ROSSI SRL VIA DELL'INDUSTRIA, 20 41042 - FIORANO (MO) - ITALY WWW.MARIOROSSI.IT	Heading
ARTICLE: APPLES CUSTOMER: BIANCHI LOT: 123456 OPERATOR: JOHN	Custom information
GROSS 30,000 kg PT 10,000 kg NET 20,000 kg	Weight data
05/01/2024 15:39:03	Date and time
	Barcode 39

### Packing list example

(only for TPW TOUCH, TWIN FORKS TOUCH SCREEN, LTW TOUCH SCREEN)

MARIO ROSSI SRL VIA DELL'INDUSTRIA, 20 41042 - FIORANO (MO) - ITALY WWW.MARIOROSSI.IT	
ARTICLE: APPLES CUSTOMER: BIANCHI LOT: 123456 OPERATOR: JOHN	
WEIGHING NR. 00000001 NET 1.000 kg	
WEIGHING NR. 00000002 NET 1.000 kg	
WEIGHING NR. 00000003 NET 1.000 kg	
WEIGHING NR. 00000004 NET 1.000 kg	
WEIGHING TOTAL 00000004 TOTAL NET 4.000 kg TICKET NR. 12345	
05/01/2024 15:39:03	
	



## Product Weight and Product Weight with Shipment Packaging

TPWN		Product Code	Product Weight (kg)	Product Weight + Packaging (kg)	Packaging Dimensions l x w x h (cm)
		TPWN-EASY	98	124	158 x 60 x 74
		TPWNBТ-X	99	125	158 x 60 x 74
		TPWNBТW-X	99	125	158 x 60 x 74

TPWLK		Product Code	Product Weight (kg)	Product Weight + Packaging (kg)	Packaging Dimensions l x w x h (cm)
		TPWLK-X	110	136	158 x 60 x 74
		TPWLKM-X	124	142	158 x 60 x 74
		TPWLKP-X	118	133	158 x 60 x 74
TPWLKPM-X	125	136	158 x 60 x 74		

TPWP		Product Code	Product Weight (kg)	Product Weight + Packaging (kg)	Packaging Dimensions l x w x h (cm)
		TPWP-X	122	136	158 x 60 x 74
		TPWPM-X	122	136	158 x 60 x 74

TPW TOUCH		Product Code	Product Weight (kg)	Product Weight + Packaging (kg)	Packaging Dimensions l x w x h (cm)
		TPWTS-X	125	145	158 x 60 x 74
		TPWTSM-X	125	145	158 x 60 x 74

TPW EX 3GD		Product Code	Product Weight (kg)	Product Weight + Packaging (kg)	Packaging Dimensions l x w x h (cm)
		TPWX3GD-X	118	139	155 x 80 x 116
		TPWX3GDM-X	118	139	155 x 80 x 116

TPW EX 2GD		Product Code	Product Weight (kg)	Product Weight + Packaging (kg)	Packaging Dimensions l x w x h (cm)
		TPWX2GD20-X	123	144	155 x 80 x 116
		TPWX2GD20M-X	123	144	155 x 80 x 116

TPWI-LK		Product Code	Product Weight (kg)	Product Weight + Packaging (kg)	Packaging Dimensions l x w x h (cm)
		TPWI-LK	130	151	155 x 80 x 116
		TPWIM-LK	130	151	155 x 80 x 116

TPWI-PRO		Product Code	Product Weight (kg)	Product Weight + Packaging (kg)	Packaging Dimensions l x w x h (cm)
		TPWI-PRO	135	151	155 x 80 x 116
		TPWIM-PRO	135	151	155 x 80 x 116

TPWI HYGIENX		Product Code	Product Weight (kg)	Product Weight + Packaging (kg)	Packaging Dimensions l x w x h (cm)
		TPWI-HGX	135	151	155 x 80 x 116
		TPWIM-HGX	135	151	155 x 80 x 116

TPWI-PRO "EX" 3GD		Product Code	Product Weight (kg)	Product Weight + Packaging (kg)	Packaging Dimensions l x w x h (cm)
		TPWI-PRO-EX3GD	137	158	155 x 80 x 116
		TPWIM-PRO-EX3GD	137	158	155 x 80 x 116

<b>TPWI-PRO "EX" 2GD</b>		Product Code	Product Weight (kg)	Product Weight + Packaging (kg)	Packaging Dimensions l x w x h (cm)
		TPWI-PRO-EX2GD	136	157	155 x 80 x 116
		TPWIM-PRO-EX2GD	136	157	155 x 80 x 116

<b>TPW "E-FORCE"</b>		Product Code	Product Weight (kg)	Product Weight + Packaging (kg)	Packaging Dimensions l x w x h (cm)
		TPWE-FORCE-x	120	141	155 x 80 x 116
		TPWE-FORCEM-x	120	141	155 x 80 x 116

## Product Weight and Product Weight with Shipment Packaging

<b>EPWL</b>		Product Code	Product Weight (kg)	Product Weight + Packaging (kg)	Packaging Dimensions l x w x h (cm)
		EPWL-x	35	38	146 x 82 x 10
		EPWLM-x	35	38	146 x 82 x 10

<b>EPWLI</b>		Product Code	Product Weight (kg)	Product Weight + Packaging (kg)	Packaging Dimensions l x w x h (cm)
		EPWLI-x	36	39	146 x 82 x 24
		EPWLIM-x	36	39	146 x 82 x 24

## Product Weight and Product Weight with Shipment Packaging

<b>ELP</b>		Product Code	Product Weight (kg)	Product Weight + Packaging (kg)	Packaging Dimensions l x w x h (cm)
		ELP-x	2,5	2,9	14,5 x 29,5 x 27,5

<b>LTP</b>		Product Code	Product Weight (kg)	Product Weight + Packaging (kg)	Packaging Dimensions l x w x h (cm)
		LTP-x	2,5	2,9	14,5 x 29,5 x 27,5

<b>TWIN FORKS COMPACT</b>		Product Code	Product Weight (kg)	Product Weight + Packaging (kg)	Packaging Dimensions l x w x h (cm)
		LTF2500C-x	164	140	137 x 47 x 90
		LTF5000C-x	164	140	137 x 47 x 90

<b>TWIN FORKS TOUCH SCREEN</b>		Product Code	Product Weight (kg)	Product Weight + Packaging (kg)	Packaging Dimensions l x w x h (cm)
		LTF2500TS-x	164	140	137 x 47 x 90
		LTF5000TS-x	164	140	137 x 47 x 90

<b>LTW COMPACT</b>		Product Code	Product Weight (kg)	Product Weight + Packaging (kg)	Packaging Dimensions l x w x h (cm)
		LTWC15-x	185	203	120 x 80 x 43
		LTWC25-x	185	203	120 x 80 x 43
		LTWC15BTH-x	185	203	120 x 80 x 43
		LTWC25BTH-x	185	203	120 x 80 x 43



<b>LTW TOUCH SCREEN</b> 	Product Code	Product Weight (kg)	Product Weight + Packaging (kg)	Packaging Dimensions l x w x h (cm)
	LTWTS15-x	185	203	120 x 80 x 43
	LTWTS25-x	185	203	120 x 80 x 43
	LTWTS15BTH-x	185	203	120 x 80 x 43
	LTWTS25BTH-x	185	203	120 x 80 x 43

## Product Weight and Product Weight with Shipment Packaging

<b>IDIMENSION® PLUS</b> 	Product Code	Product Weight (kg)	Product Weight + Packaging (kg)	Packaging Dimensions l x w x h (cm)
	204599	15,5	19,5	103 x 59 x 24
	204596	15,5	19,5	103 x 59 x 24
	204600	15,5	19,5	103 x 59 x 24
	204598	15,5	19,5	103 x 59 x 24

<b>IDIMENSION® PLUS XL</b> 	Product Code	Product Weight (kg)	Product Weight + Packaging (kg)	Packaging Dimensions l x w x h (cm)
	204601	1,5	5,5	65 x 38 x 18
	204602	1,5	5,5	65 x 38 x 18

NOTES

---



---



---



---







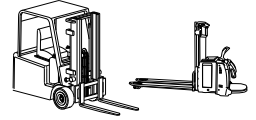

---



Forklifts  
 Electric pallet trucks  
 Hydraulic sensor technology  
 Load cell technology  
 Legal for trade  
 Printer  
 Wireless connection  
 Wired connection  
 FEM2A plate  
 FEM2B plate  
 FEM3A plate



	Forklifts	Electric pallet trucks	Hydraulic sensor technology	Load cell technology	Legal for trade	Printer	Wireless connection	Wired connection	FEM2A plate	FEM2B plate	FEM3A plate		
p. 54		●	●			○		●					ELP
p. 56	●		●			○		●	●	○	○		LTP
p. 58	●			●	○	○	●		●	○	○		TWIN FORKS COMPACT
p. 60	●			●	○	○	●		●	○	○		TWIN FORKS TOUCH SCREEN
p. 62	●			●	○	○	●	●	●	●	○		LTW COMPACT
p. 64	●			●	○	○	●	●	●	●	○		LTW TOUCH

WEIGHING KITS FOR FORKLIFTS AND ELECTRIC PALLET TRUCKS

Plug & Play Solution  
 Modules for integration  
 Integration with scales  
 Camera 4K



	Plug & Play Solution	Modules for integration	Integration with scales	Camera 4K		
p. 72	●		○	●		IDIMENSION® PLUS
p. 74		●	○	●		IDIMENSION® PLUS XL

DIMENSIONING SYSTEMS



Dini Argeo dealer network:  
over 3500 partners  
in more than 130 countries across the world

“YOUR WORLDWIDE PARTNER  
FOR WEIGHING”

## WHY CHOOSE DINI ARGEO?



### COMPANY HEADQUARTERS

Via Della Fisica, 20  
41042 Spezzano di Fiorano - Modena - Italy  
Tel. +39.0536 843418

### SERVICE ASSISTANCE

Via Dell'Elettronica, 15  
41042 Spezzano di Fiorano - Modena - Italy  
Tel. +39.0536 921784

### OTHER DINI ARGEO LOCATIONS

DINI ARGEO WEIGHING INSTRUMENTS Ltd  
China

DINI ARGEO UK Ltd  
United Kingdom

DINI ARGEO FRANCE sarl  
France

DINI ARGEO GMBH  
Germany

DINI ARGEO OCEANIA  
Australia



### WORLDWIDE SERVICE AND SHIPPING

International group  
with offices in America,  
Europe, India, China,  
Mexico and Oceania,  
over 1100 employees  
and a network of  
specialised partners  
in 130 countries  
worldwide.



### FAST SHIPPING

Dini Argeo always  
keeps complete  
systems in stock that  
can be shipped quickly.



### MADE IN ITALY

Dini Argeo weighing  
solutions are made in  
Italy and guarantee  
the highest quality  
standards.

The information in this document is approximate  
and can be subject to variations without prior  
notice by Dini Argeo, with respect of the norms in  
force.

The official technical data is available in the  
updated version on the [www.diniargeo.com](http://www.diniargeo.com) web site  
or by contacting the Dini Argeo Customer Service.

SALES SERVICE AND TECHNICAL ASSISTANCE



LOGI-W-CEN  
Rev. 01/01/2025