



PORTABLE WEIGHING
PLATFORMS
WWS SERIES

CATALOGUE

 **DINI ARGEO**
Scales - Weighing systems

A RICE LAKE WEIGHING SYSTEMS COMPANY



VEHICLE AND SPECIAL EQUIPMENT WEIGHING

Portable Platforms
WWS Series



Dini Argeo is an Italian company specializing in the design and manufacture of scales and weighing systems that have gained a sound reputation on the world market for their quality, reliability and versatility of use.

For over two decades, Dini Argeo has been the market leader in the production of weighing platforms employing load cell technology for superior weighing performance.

Discover the wide range of WWS series platforms and contact your local dealer for more information.



WWS PLATFORMS, THE IDEAL SOLUTION FOR WEIGHING VEHICLES AND SPECIAL EQUIPMENT

WWS platforms are the original Dini Argeo weighing systems and are **the most robust and reliable on the market.**

They are ideal for quickly and easily weighing vehicles and structures **with multiple bearing points** including trucks, tractors, tankers, airplanes, containers, canisters, crates and more!



A WORLD OF APPLICATIONS

WWS portable weighing systems are particularly suitable for **mobile and stationary weighing stations**. They are lightweight and easy to transport and use, so weighing station can be set up on any flat surface in a matter of minutes.

The main applications include:



ROADS

WWS platforms are chosen by many police stations, road management companies and ministries of transport for measuring the weight of wheels and axles of vehicles on the road.



AGRICULTURE

WWS portable platforms are also the ideal weighing solution for temporary or seasonal applications, for instance during harvests, with no need for excavation or masonry work.



RACING AND AUTOMOTIVE

WWS portable platforms are useful to ensure maximum safety in the auto racing industry by checking the center of gravity and weight suitability of cars before races.



AVIATION

WWS platforms can be used to check the center of gravity and load distribution of all types of aircraft.



SPECIAL VEHICLES AND EQUIPMENT

WWS platforms are ideal for weighing vehicles and structures with multiple support points, such as telescopic handlers, aerial platforms and more.



CONTAINERS AND LOGISTICS

WWS platforms can also be used to weigh containers and bins used at ports, hubs, customs and logistics centers.

THE MAIN WEIGHING FUNCTIONS



STATIC AXLE WEIGHING

Axle scales in static mode allow the **vehicle to be weighed by summing the weights of individual axles**. In addition to being the most cost-effective way to weigh vehicles, they prevent penalties due to overloaded axles and are particularly suitable when the weighing location needs to be changed frequently.



DYNAMIC AXLE WEIGHING

The dynamic axle scales consist of one or two weighing modules. **The weight is acquired as the vehicle passes over the scale** without the need to stop for each axle. The devices are particularly suitable for frequent weighing operations or when placed at the entry or exit of industrial plants to avoid queues and traffic jams.



VEHICLE WEIGHING

Portable vehicle scales are **modular weighing systems with up to 16 weighing platforms**. Due to the simultaneous weighing of each wheel of the vehicle, the weighing accuracy is comparable to that of a weighbridge.

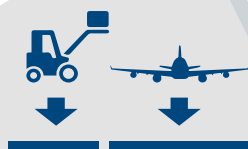

WEIGHING OF AIRCRAFT, VEHICLES, AND SPECIAL EQUIPMENT

Portable scales are the ideal solution for **checking the weights of special vehicles**, such as helicopters, airplanes, tractors or even large structures with different support points, with or without wheels.



Static Axle Weighing



Dynamic Axle Weighing



Vehicle Weighing



Vehicle Weighing



Weighing of Aircraft, Vehicles, and Special Equipment



Weighing of Aircraft, Vehicles, and Special Equipment

DISCOVER THE BENEFITS

Our WWS platforms are the ideal solution for achieving high performance when weighing vehicles and other equipment.

Choose them because:



They are ideal for creating mobile weighing stations that do not require excavation or masonry work.



They are built using high-quality components and with the utmost attention to detail.



They are made in Italy to ensure complete supply chain control and fast delivery.



They are rugged and durable because they are made of special alloys.



They are CE-approved according to Directive 2014/31/EU and legal for trade.



THE RANGE

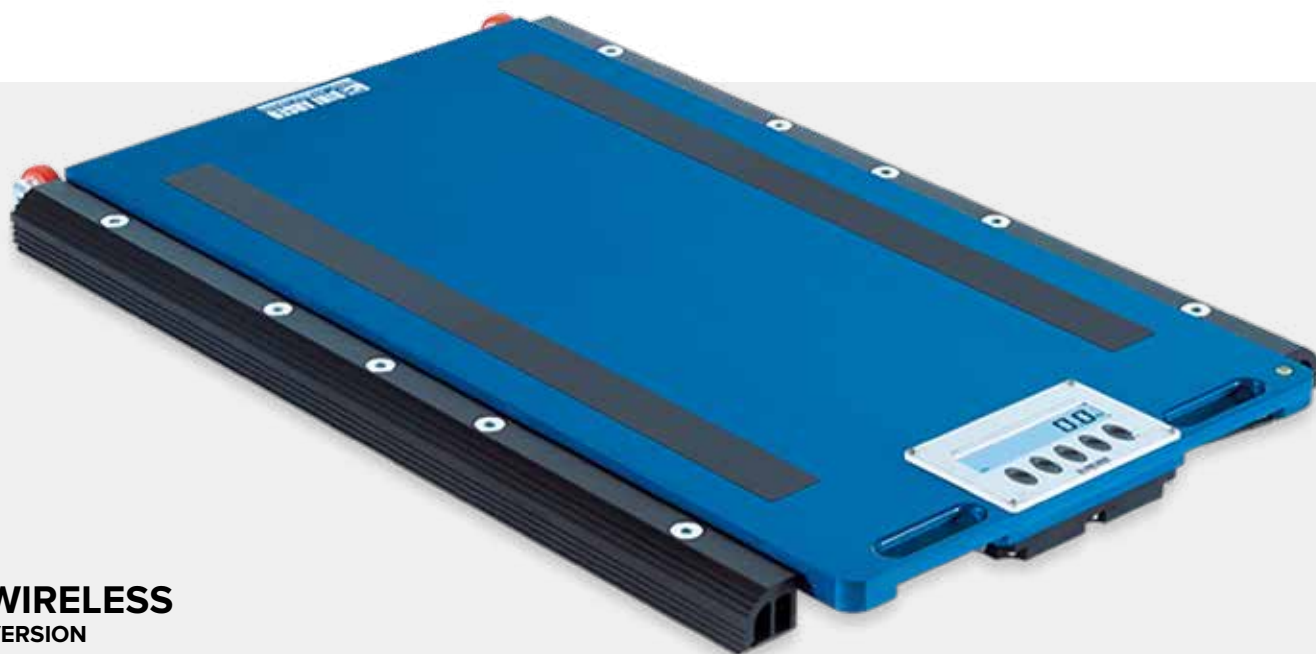

WIRELESS
VERSION

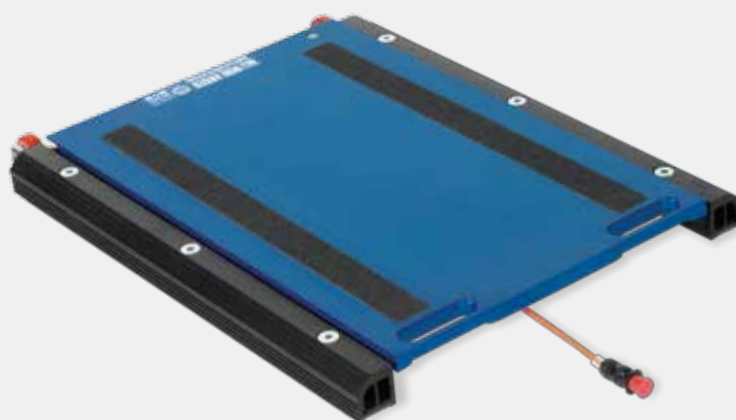

WIRED
VERSION

WIRELESS VERSION

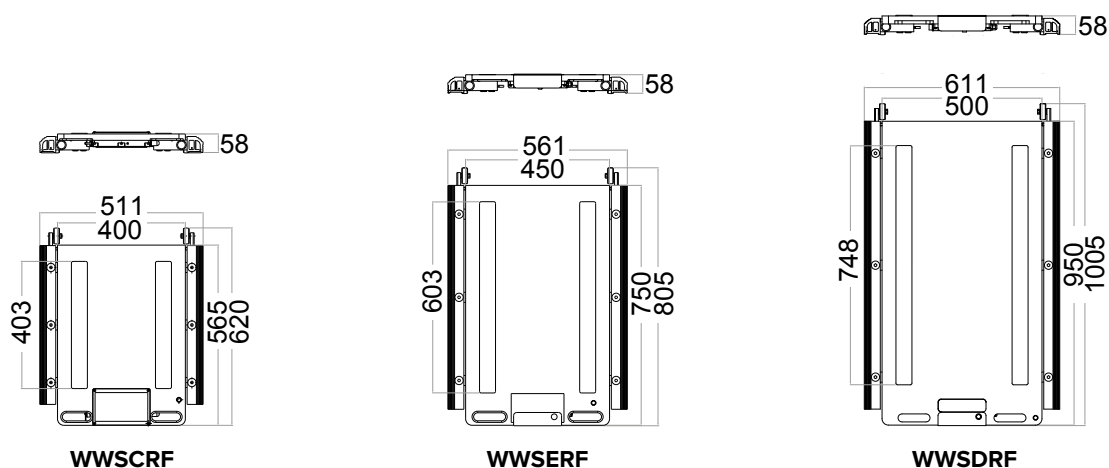

TECHNICAL FEATURES

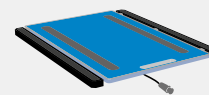
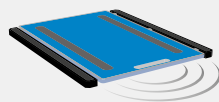

WIRELESS VERSION

WIRED VERSION

Low height (only 58 mm, 75 mm for WWSF model)	✓	✓
Special aluminum alloy structure: strong and durable	✓	✓
Stainless steel load cells	✓	✓
IP68 protection rating	✓	✓
Bubble level	✓	✓
Weight indicator integrated in the platform with IP68 protection rating	✓	-
Communication and transmission of weight data to remote indicator or external device	Wireless	Wired
Wheels for moving the platform	✓	✓
Ergonomic carrying handles	✓	✓
Rechargeable internal battery	✓	-
Non-slip rubber for maximum grip on any surface	✓	✓
CE-M approval	✓	✓
OIML R134 approval for dynamic weighing	-	✓

WIRED VERSION

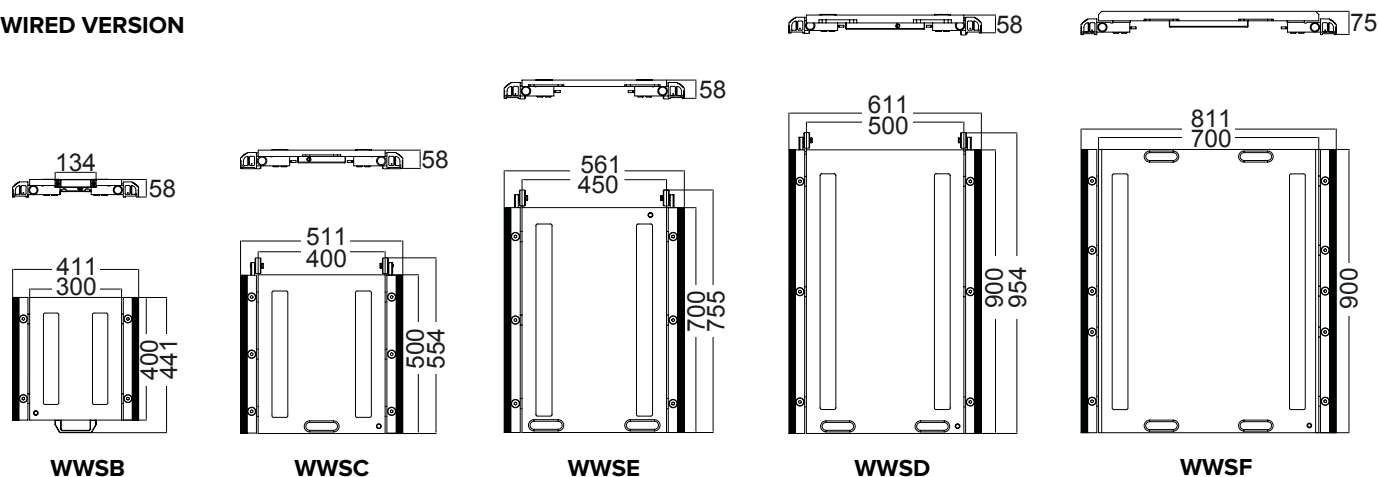

MODULAR SOLUTIONS: WEIGHT INDICATOR IN SUITCASE

3590ETKR
TOUCHSCREEN



**PROTECTIVE
CARRYING
SUITCASE,
STANDARD
EQUIPMENT**

DIM. (W X L X H)
325 X 460 X 170 MM



3590EKR

DFWKRP

FUNCTIONS

WHEEL WEIGHING MODE

- Vehicle weight acquisition in one step
- Automatic calculation of x and y coordinates of the center of gravity
- Ticket printing and list display of the last 3.500 vehicles

AXLES WEIGHING MODE

- Vehicle weighing by adding up the weight of each axle, either manually or automatically while the vehicle passes over the platforms
- Vehicle entry/exit weighing
- Automatic or manual totaling of the weight of each axle and calculation of the total mass of the vehicle
- Ticket printing and display list last 3.500 axles

TOTAL MANAGEMENT

- Three levels of total, independently printable and resettable:
 - total current vehicle
 - total weighed vehicles
 - grand total
- Vehicle tare management

ARCHIVE AND SAVING

- Data file that can be filled in manually by the operator (registration, license plate, material transported, customer, supplier, etc.)
- Archive of 1.000 memory positions with programmable password, each consisting of 5 alphanumeric descriptions for vehicle, customer, and material management
- Type-approved software, Legal for Trade

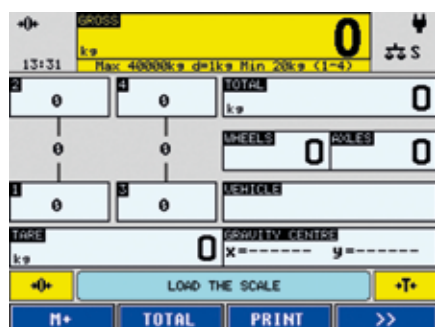

WHEEL WEIGHING MODE



AXLE WEIGHT MODE

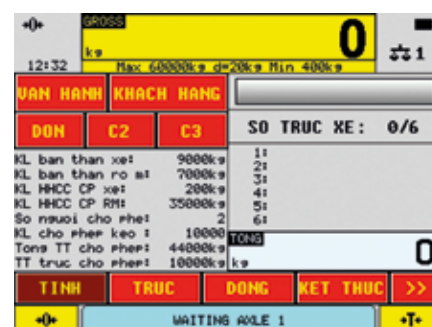

TOTAL MANAGEMENT

FULLY CUSTOMIZABLE PC SOFTWARE

MYRIAS® SOFTWARE SOLUTION

With more than 30 years of successful development and installations, Myrias® software allows you to:

- Record vehicle load data and empty weight data
- Read vehicle and trailer identification data
- Weigh multi-axle vehicles

It is also compatible with the main weight indicators and can communicate with printers, traffic lights, barriers and cameras for complete control of the weighing process.

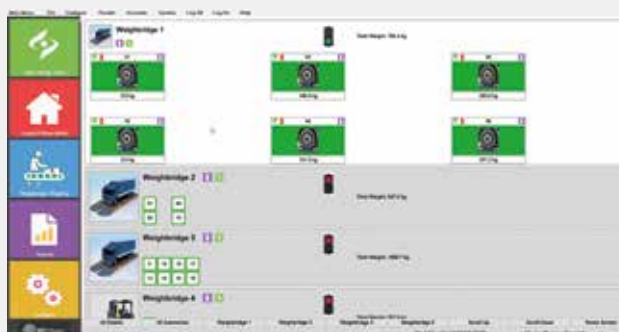

WEIMONITOR

WeiMonitor is a PC program for monitoring and recording in real-time all the weight measurements performed on the connected scale, storing them in an Excel or text file for later processing.

Main functions:

- Weight display with semi-automatic tare management using a dedicated button
- Manual recording at the press of a key of your choice on a PC or directly on a scale
- Automatic "timed" recording with programmable reading frequency
- Saving data to Excel (.xls) or text (.txt) files
- Keyboard emulation for entering weight data directly into the active Windows application enabling the compilation of bills, documents, invoices, etc.
- Approved operation with a recording of weighing ID (alibi memory in the indicator is needed)



FULL TRACEABILITY

TICKETS FULLY CUSTOMIZABLE

EXAMPLE:

- Ⓐ Entry/exit weighing
- Ⓑ Wheel and axle weighing



MARIO ROSSI SRL

VIA INDIPENDENZA 157 - MILANO
www.mario-rossi.it
0039 - 0278223154

Client:
BROWN LTD
PLATE: AA000BC

Material:
CLAY

Operator:
ALESSIO

ENTRY PT 50000kg
 10000kg

EXIT PT 20000kg
 10000kg

UNLOADING 30000kg

***** HAVE A GOOD DAY *****

MARIO ROSSI SRL

VIA INDIPENDENZA 157
MILANO

WHEEL 1	5000kg
WHEEL 2	5000kg
AXLE 1	10000kg
WHEEL 3	5000kg
WHEEL 4	5000kg
AXLE 2	10000kg
WHEEL 5	5000kg
WHEEL 6	5000kg
AXLE 3	10000kg
WHEEL 7	5000kg
WHEEL 8	5000kg
AXLE 4	10000kg
WHEEL 9	5000kg
WHEEL 10	5000kg
AXLE 5	10000kg

TOTAL 50000kg
TARE 3500kg
NET 46500kg

22/12/2012 17:00

USB FLASH DRIVE FOR STORING WEIGHTING RESULTS TO PC



Storing all weighing data is important to ensure that all the performed operations are fully traceable. All data are available in Excel format and **more than 5.000.000 weighing results can be stored.**

Veicolo	Targa	Cliente	Operatore	Data	Ora	Materiale	Asse 1(kg)	Asse 2(kg)	Asse 3(kg)	Asse 4(kg)	Asse 5(kg)	Totale(kg)	
1													
2													
3	IVECO	AB129CD	ROSSI srl	Marco	22/11/2012	16:40	Argilla	12000	16000	14500	16400	15100	74200
4	RENAULT	AA47LDH	Verdi spa	Andrea	23/11/2012	08:45	Carilino	13000	18000	24000	23500	22000	100500
5													







CONFIGURATIONS

APPLICATION DIAGRAMS

EXAMPLE OF AXLE WEIGHING MODE



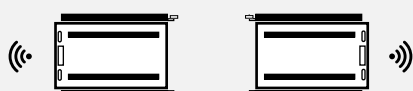

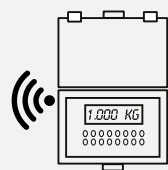





Configuration Benefits:

- It can add up the weight of each axle
- It is the fastest and most cost-effective solution
- Wireless and wired versions are available

EXAMPLE OF WHEEL WEIGHING MODE



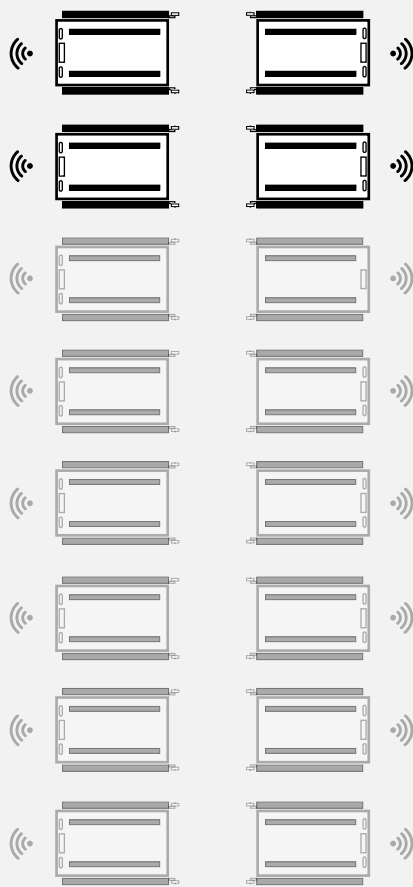

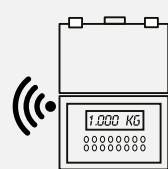





Configuration Benefits:

- It allows the total weight of the vehicle to be acquired in a single operation
- It is the most precise solution, also Legal for Trade
- It is the most versatile solution, easily adapting to all the support points of the object to be weighed
- Wireless and wired versions are available

Up to 16 weighing platforms

Versions - Analog Platforms

		Max (kg)	d (kg)	M (kg)	d HR (kg)*	l (mm)	w (mm)	h (mm)	Code
WWSB		600	0,2	0,2	-	400	300	58	WWSB600-x
		1.500	0,5	0,5	-				WWSB1500-x
		3.000	1	1	0,1				WWSB3T-x
		6.000	2	2	0,2				WWSBT6-x
		8.000	5	5	0,5				WWSB8T-x
WWSC		1.500	0,5	0,5	0,05	500	400	58	WWSC1.5T-x
		3.000	1	1	0,1				WWSC3T-x
		6.000	2	2	0,2				WWSC6T-x
		10.000	5	5	0,5				WWSC10T-x
		15.000*	5	5	0,5				WWSC15T-x
WWSE		6.000	2	2	0,2	700	450	58	WWSE6T-x
		10.000	5	5	0,5				WWSE10T-x
		15.000*	5	5	0,5				WWSE15T-x
WWSD		6.000	2	2	0,2	900	500	58	WWSD6T-x
		10.000	5	5	0,5				WWSD10T-x
		15.000	5	5	0,5				WWSD15T-x
		20.000**	10	10	1				WWSD20T-x
WWSF		10.000	5	5	0,5	900	700	75	WWSF10T-x
		15.000	5	5	0,5				WWSF15T-x
		20.000**	10	10	1				WWSF20T-x
		25.000	10	-	1				WWSF25T-x

(*) In combination with ECEM approval, max. load capacity 12.500 kg

(**) In combination with ECEM approval, max. load capacity 15.000 kg



Versions - Wireless platforms

		Max (kg)	d (kg)	M (kg)	d HR (kg)*	l (mm)	w (mm)	h (mm)	Code
WWSERF		1.500	0,5	0,5	0,5	565	400	58	WWSERF1.5T-x
		3.000	1	1	0,1				WWSERF3T-x
		6.000	2	2	0,2				WWSERF6T-x
		10.000	5	5	0,5				WWSERF10T-x
		8.000	5	5	0,5				WWSERF8T-x
WWSERF		6.000	2	2	0,2	750	450	58	WWSERF6T-x
		10.000	5	5	0,5				WWSERF10T-x
		15.000*	5	5	0,5				WWSERF15T-x
WWSERF		6.000	2	2	0,2	950	500	58	WWSERF6T-x
		10.000	2	2	0,5				WWSERF10T-x
		15.000	2	2	0,5				WWSERF15T-x
		20.000**	10	10	1				WWSERF20T-x









(*) In combination with ECEM approval, max. load capacity 12.500 kg

(**) In combination with ECEM approval, max. load capacity 15.000 kg







High resolution

		Description	Code
HIGH RESOLUTION VERSION		High-resolution version for internal factory use.	EHR

Legal for trade and calibration certificates



		Description	Code
APPROVAL		CE-M approval for single platform/balance.	ECM
		CE approval for static axle weighing system with WWS and 3590 touchscreen, with AF09 weighing program.	ECEMAXLE
		EU Declaration of Conformity, EU Verification Certificate, Test Certificate, and Metrology Booklet, in paper format (free download from the website, available only for CE-M approved scales).	ECEMDOC
ISO 17025:2017 CALIBRATION CERTIFICATE		For load capacities from 301 to 1.500 kg per single scale/platform.	CT6
		For load capacities from 1.501 to 3.000 kg per single scale/platform.	CT7
		For load capacities from 3.001 to 6.000 kg per single scale/platform.	CT8
CALIBRATION SERVICES ISO 9001:2015		For capacities from 1.501 to 6.000 kg, per single scale/platform.	CD3
		For capacities from 6.001 to 15.000 kg, for single scale/platform.	CD4

International cables and sockets

















		Description	Code
POWER CABLES		Version with AU power cord.	PWCORDAUSVDE
		Version with BS1363 power cord (UK plug).	PWCORDUKVDE
		Version with US type B power cord. (Japan, North and Central America).	PWCORDUSVDE
POWER SOCKETS		Version with AU charger.	AUS-V4
		Version with UK charger.	UK-V4
		Version with US charger.	US-V4

(PRODUCT CODE-x): For the current code version please refer to www.diniargeo.com

Saving weighing data

		Description	Code
SAVING WEIGHING DATA		Built-in USB port kit for indicator in transport case. It does not occupy serial ports. Complete of USB key for PC. NOTE: this interface is not available on its own, always to be combined with a weight indicator when ordering.	USBEGTKR
		Set of 5 USB flash drives for saving weighing data.	USBK

Main options











	ANALOG PLATFORMS	WIRELESS PLATFORMS		Description	Code
MAIN CONNECTABLE WEIGHT INDICATORS	<input type="radio"/>			Weight indicator in a suitcase for carrying, with built-in printer. Provided with a specific program for vehicle weighing, 17-key keypad, backlit LCD, and calendar clock.	DFWKR2G4-x
	<input type="radio"/>			Weight indicator in a suitcase with printer and AF09 program. 25-key keyboard, LED display, and graphic LCD.	3590EKR-x
	<input type="radio"/>			Touchscreen indicator in a suitcase with printer and AF08 program. Color display.	3590ETKR-x
	<input type="radio"/>			Weight indicator in a suitcase for carrying, with built-in printer. Provided with a specific program for weighing vehicles, 17-key keypad, backlit LCD, calendar clock, and radio module.	DFWKR2G4-x
	<input type="radio"/>			Weight indicator in a suitcase with printer, AF09 program, and radio module. 25-key keyboard, LED display, and graphic LCD.	3590EKR2G4-x
	<input type="radio"/>			Touchscreen indicator in a suitcase with printer and AF08 program. Color display and wireless module.	3590ETKR2G4-x
	<input type="radio"/>			Touchscreen indicator in a suitcase with printer and AF09 program. Color display.	3590ETKR09-x
	<input type="radio"/>			Touchscreen indicator in a suitcase with printer and AF09 program. Color display and wireless module.	3590ETKR2G4-AF09-x
WEIGHING SOFTWARE FOR TOUCHSCREEN INDICATOR	<input type="radio"/>			Program for weighbridges, vehicle entry/exit. For 3590 and CPW weight indicators.	AF03
	<input type="radio"/>			Static wheel and axle weighing program with 2 or more platforms.	AF08
	<input type="radio"/>			Program for dynamic or static 1- or 2-platform axle weighing.	AF09
	<input type="radio"/>			Program for weighbridges, vehicle entry/exit For 3590 "TOUCHSCREEN" series weight indicators.	AF03GT
CONNECTION CABLE	<input type="radio"/>			10 m PUR spare cable for platforms WWS, with an IP68 connector on the platform side and a new M12 connector on the indicator side.	CBWWSOVN
REMOTE CONTROLS		<input type="radio"/>		Radio frequency remote control and receiver with extension, for installations where other option boards with connection to AMP are required.	TLRP 

● As standard ○ Optional

(PRODUCT CODE-x): For the current code version please refer to www.diniargeo.com

 Installation at time of order.

Ramps and leveling modules

	WWSB	WWSC	WWSE	WWSA	WWSF	WWSCRF	WWSERF	WWSDRF		Description	Code
RAMPS	<input type="radio"/>									Ramp dimensions 400 x 200 x 54 mm.	WWSBR
		<input type="radio"/>				<input type="radio"/>				Single aluminum ramp. Dimensions 500 x 150 x 30 mm.	WWSCR
			<input type="radio"/>				<input type="radio"/>			Single aluminum ramp. Dimensions 700 x 150 x 30 mm.	WWSER
				<input type="radio"/>	<input type="radio"/>		<input type="radio"/>	<input type="radio"/>		Single aluminum ramp. Dimensions 900 x 150 x 30 mm.	WWSDR
INSTALLATION FLUSH WITH THE FLOOR		<input type="radio"/>				<input type="radio"/>				Frame for flush installation.	WWSCTF
			<input type="radio"/>				<input type="radio"/>			Frame for flush installation.	WWSETF
				<input type="radio"/>			<input type="radio"/>			Frame for flush installation.	WWSDTF
					<input type="radio"/>					Frame for flush installation.	WWSFTF
LEVELING MODULES			<input type="radio"/>				<input type="radio"/>			"Easy Level" kit, consisting of 12 leveling modules and 4 ramps.	LMEK12
				<input type="radio"/>				<input type="radio"/>		"Easy Level kit, consisting of 20 leveling modules and 4 ramps.	LMDK18



IN-DEPTH VIDEO

Frame the QR code to view the EASY LEVEL leveling module installation video.



Installations with leveling modules.

- As standard
- Optional

(PRODUCT CODE-x): For the current code version please refer to www.diniargeo.com

WWS PLATFORMS CERTIFIED TO GUARANTEE THE HIGHEST WEIGHING ACCURACY



Our **special equipment**, including certified masses, allows each WWS platform to be verified up to 15.000 kg, ensuring correct calibration and accuracy of the weighing system.



Dini Argeo manufactures instruments that are approved or legal for trade according to **European standard EN 45501** and **Directive 2014/31/EU**. The metrological marking indicates that the instrument has a certificate of approval or type examination issued by a European Notified Body, validating its suitability for legal use. This approval is essential for all legal for trade uses.



Our platforms comply with the requirements defined by the recommendations of the **International Organization of Legal Metrology (OIML)**:

- OIML R60 approval for load cells
- OIML R76 approval for non-automatic weighing instruments
- OIML R134 approval for dynamic weighing of low-speed transit vehicles



Dini Argeo calibration and recalibration services, performed according to **ISO/IEC 17025:2017** and **UNI EN ISO 9001:2015** quality standards, ensure efficient axle and wheel weighing systems that meet metrological standards.



NOTES

NOTES

Dini Argeo dealer network:
over 3500 partners
in more than 85 countries across the world

“YOUR WORLDWIDE PARTNER
FOR WEIGHING”



A RICE LAKE WEIGHING SYSTEMS COMPANY

COMPANY HEADQUARTERS

Via Della Fisica, 20
41042 Spezzano di Fiorano Modena • Italy
Tel. +39.0536 843418

SERVICE ASSISTANCE

Via Dell'Elettronica, 15
41042 Spezzano di Fiorano Modena • Italy
Tel. +39.0536 921784

OTHER DINI ARGEO LOCATIONS

DINI ARGEO WEIGHING INSTRUMENTS Ltd
China

DINI ARGEO UK Ltd
United Kingdom

DINI ARGEO FRANCE sarl
France

DINI ARGEO GMBH
Germany

DINI ARGEO OCEANIA
Australia

WHY CHOOSE DINI ARGEO?



WORLDWIDE SERVICE AND SHIPPING

International group with offices in America, Europe, India, China, Mexico and Oceania, over 900 employees and a network of specialised partners in 130 countries worldwide.



FAST SHIPPING

Dini Argeo always keeps complete systems in stock that can be shipped quickly.



MADE IN ITALY

Dini Argeo weighing solutions are made in Italy and guarantee the highest quality standards.

SALES SERVICE AND TECHNICAL ASSISTANCE

Mod **WWS-CEN**

P/N 
WWS-CEN

Sn 
NOSN

WWS-CEN/NOSN

Rev. 01.07.2023