

THURMAN

THURMAN®

Thurman Price Index By Rice Lake Weighing Systems PN

RL PN	SUGG. LIST	PAGE #	RL PN	SUGG. LIST	PAGE #	RL PN	SUGG. LIST	PAGE #
10772	CONSULT	252	TH901P	CONSULT	250	TH923P	CONSULT	248
10993	CONSULT	252	TH902P	CONSULT	250	TH924P	CONSULT	248
15290	CONSULT	NOT SHOWN	TH903P	CONSULT	250	TH926	CONSULT	249
18815	CONSULT	252	TH904P	CONSULT	250	TH927	CONSULT	252
18816	CONSULT	252	TH905P	CONSULT	249	TH928P	CONSULT	248
21912	CONSULT	254	TH907P	CONSULT	250	TH929P	CONSULT	249
21922	CONSULT	249	TH908P	CONSULT	250	TH939P	CONSULT	248
22910	CONSULT	248	TH909P	CONSULT	250	TH945	CONSULT	251
33645	CONSULT	252	TH910	CONSULT	251	TH946P	CONSULT	248
33646	CONSULT	252	TH911	CONSULT	251	TH947	CONSULT	253
33647	CONSULT	254	TH912	CONSULT	251	TH948	CONSULT	253
33648	CONSULT	252	TH913	CONSULT	251	TH950	CONSULT	254
33649	CONSULT	252	TH914	CONSULT	251	TH952SS	CONSULT	254
33650	CONSULT	254	TH915	CONSULT	251	TH954SS	CONSULT	254
33653	CONSULT	254	TH916	CONSULT	249	TH966	CONSULT	254
33654	CONSULT	254	TH917	CONSULT	249	TH970	CONSULT	251
33905	CONSULT	253	TH918	CONSULT	253			
33906	CONSULT	253	TH919	CONSULT	253			
33907	CONSULT	253	TH921	CONSULT	251			
65430	CONSULT	254	TH922P	CONSULT	248			
72192	CONSULT	251						
75115	CONSULT	253						
H644	CONSULT	252						
H648	CONSULT	252						
H697	CONSULT	251						

THURMAN®

*Item obsolete or discontinued. When remaining stock is depleted, published prices are withdrawn and the item is subject to a special order quote.

XX Call for details.

Thurman Cross Reference By Equivalent Thurman Number

EQUIV. NEW THURMAN #	EQUIV. OLD THURMAN #	RL PN	EQUIV. NEW THURMAN #	EQUIV. OLD THURMAN #	RL PN	EQUIV. NEW THURMAN #	EQUIV. OLD THURMAN #	RL PN
300181	T-181	TH939P	10004350		TH958SS	10008690Y	T-269	TH918
10000140A		33654	10004480A		TH964SS	10008710A	T-255-1	TH901P
10000170A		TH952SS	10004770A		TH962SS	10012030A	T-251	33649
10000190A		18815	10004810A		TH959SS	10012040A	T-1079-4	TH970
10001450A		18816	10004820A		TH949SS	10012420A	T-125	TH923P
10001520A		TH953SS	10005790A	T-675	TH945	10012700A	T-11	TH914
10001630A		TH954SS	10005800A	T-12-1	TH911	10012770A		22910
10001640A		33653	10005820A	T-270	TH919	10012860A	T-1155-1	TH902P
10002320A	T-14-4	TH930P	10005830A	T-250-1	33646	10012970A	T-47-1	TH942P
10002400A		33651	10005850A	T-12	TH910	10012980A	T-11-1	TH915
SP10002400A		33650	10005860A		33906	10013810A		TH927
10002410A		TH957SS	10005980A	T-1155-2	TH905P	10013950A	T-250	33645
10003020A		TH960SS	10007420A	T-63-1S	TH926	10013960A	T-251-1	33648
10003190A		TH950	10008490A	T-1155-4	TH907P	10014240A	T-125-1	TH924P
10003200A		TH966	10008500A	T-1155-5	TH908P	10014870A		21922
10003220A		21912	10008550A	T-979	TH912	10015960A	T-96	TH928P
10003970A	T-115-2	33907	10008560A	T-979-1	TH913	10017370A	T-197	TH929P
10004080A	T-122-1	TH947	10008590A	T-1155	TH903P	10018420A		65430
10004080Y	T-1626	75115				10019610A	T-14-1	TH935P
10004340A		TH961SS				10021340A		17749
						10022410	T-1053-10	TH921
						10028830A		33652
							10030540A	
							N/A	T-14-2
							N/A	T-14-3
							N/A	T-47
							N/A	T-47-2
							N/A	T-96-1
							N/A	T-96-2
							N/A	T-181-1
							N/A	T-191
							N/A	T-192
							N/A	T-197-1
							N/A	T-255
							N/A	T-255-2
							N/A	T-1155-3
							N/A	T-1155-6



Individual Thurman Scale Parts

Pivots

RL PN	DESCRIPTION	THURMAN NEW #	SUGG. LIST
TH923P	Equiv. Thurman no. T-125 Equiv. new Thurman no. 10012420A Size: 3/8 in x 3/8 in x 2 3/4 in long Pivot	65869	Consult
TH924P	Equiv. Thurman no. T-125-1 Equiv. new Thurman no. 10014240A Size: 3/8 in x 3/8 in x 3 3/4 in long Pivot		Consult
TH922P	Equiv. Thurman no. T-47-2 Size: 1/2 in x 1/2 in x 2 1/4 in long Pivot		Consult
22910	Equiv. Thurman no. 10012770A Size: 1/2 in x 1/2 in x 2 3/4 in long Pivot	65879	Consult
TH928P	Equiv. Thurman no. T-96 Equiv. new Thurman no. 10015960A Size: 5/8 in x 5/8 in x 4 in long Pivot	66076	Consult
TH939P	Equiv. Thurman no. T-181 Equiv. new Thurman no. 300181 Size: 1 1/8 in x 1 1/8 in x 7 3/4 in long Pivot	72189	Consult
TH946P	Equiv. Thurman no. T-181-1 Size: 1 1/8 in x 1 1/8 in x 9 in l Pivot	66504	Consult
TH929P	Equiv. Thurman no. T-197 Equiv. new Thurman no. 10017370A Size: 3/8 in x 7/8 in x 1 in long Pivot	66295	Consult

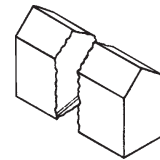
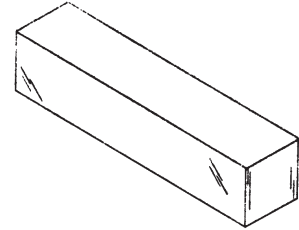

THURMAN®

Individual Thurman Scale Parts

Pivots (Cont.)

RL PN	DESCRIPTION	THURMAN NEW #	SUGG. LIST
TH901P	Equiv. Thurman no. T-255-1 Equiv. new Thurman no. 10008710A Size: 1/2 in x 1 in x 1 7/8 in long With spot drill Pivot	65647	Consult
TH904P	Equiv. Thurman no. T-255 Size: 1/2 in x 1 in x 3 3/4 in long With spot drill Pivot		Consult
TH902P	Equiv. Thurman no. T-1155-1 Equiv. new Thurman no. 10012860A Size: 1/2 in x 1 in x 2 1/4 in long Pivot	65889	Consult
TH903P	Equiv. Thurman no. T-1155 Equiv. new Thurman no. 10008590A Size: 1/2 in x 1 in x 3 3/4 in long Pivot	65628	Consult
TH905P	Equiv. Thurman no. T-1155-2 Equiv. new Thurman no. 10005980A Size: 1/2 in x 1 in x 5 11/16 in long Pivot	65319	Consult
TH907P	Equiv. Thurman no. T-1155-4 Equiv. new Thurman no. 10008490A Size: 1/2 in x 1 in x 7 3/4 in long Pivot	65610	Consult
TH908P	Equiv. Thurman no. T-1155-5 Equiv. new Thurman no. 10008500A Size: 1/2 in x 1 in x 11 in long Pivot	65613	Consult
TH909P	Equiv. Thurman no. T-1155-6 Size: 1/2 in x 1 in x 12 3/16 in long Pivot		Consult

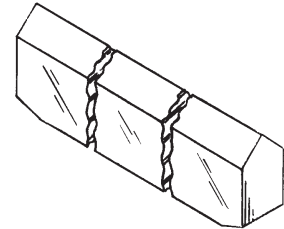
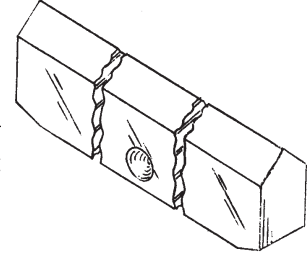

THURMAN®

Individual Thurman Scale Parts

Bearings

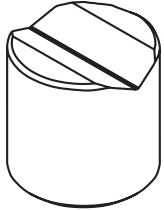
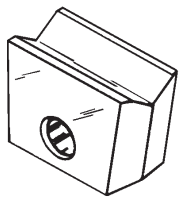
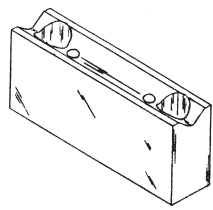
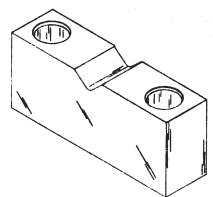
RL PN	DESCRIPTION	THURMAN NEW #	SUGG. LIST	
21922	Equiv. Thurman no. Equiv. new Thurman no. 10014870A Size: 1 in dia x 1 in Bearing	65950	Consult	
TH926	Equiv. Thurman no. T-63-1S Size: 1/2 in x 3/4 in x 1 in long Bearing, fits casting no. T-339		Consult	
TH916	Equiv. Thurman no. T-192 Equiv. new Thurman no. 10007420A Size: 1 1/8 in x 2 in x 4 3/4 in long Bearing, truck scale With pins		Consult	
TH917	Equiv. Thurman no. T-191 Size: 1 1/8 in x 2 in x 4 3/4 in long Bearing, truck scale		Consult	

THURMAN®

Individual Thurman Scale Parts

Bearings (Cont.)

RL PN	DESCRIPTION NEW #	THURMAN	SUGG. LIST
TH914	Equiv. Thurman no. T-11 10012700A Size: 2 1/8 in x 1 in x 3 5/8 in long Bearing, load with 2 dowel holes And a tapered shank Use roll pin no. 15290	65874	Consult
TH910	Equiv. Thurman no. T-12 Equiv. new Thurman no. 10005850A Size: 2 in x 1 in x 5 5/8 in long Bearing, load with 2 dowel holes And a tapered shank Use roll pin no. 15290	65298	Consult
TH912	Equiv. Thurman no. T-979 Equiv. new Thurman no. 10008550A Size: 2 in x 1 1/4 in x 7 9/16 in long Bearing, load with 2 dowel holes And a tapered shank Use roll pin no. 15290	65621	Consult
TH921	Equiv. Thurman no. T-1053-10 Equiv. new Thurman no. 10022410A Size: 1 1/4 in x 2 in x 10 3/4 in long Bearing, load with 2 dowel holes And a straight shank Use roll pin no. 15290	66413a	Consult
TH945	Equiv. Thurman no. T-675 Equiv. new Thurman no. 10005790A Size: 1 1/2 in x 1 in x 3 1/4 in long Rocker use with TH911 & TH915	65280	Consult
TH970	Equiv. Thurman no. T-1079-4 Equiv. new Thurman no. 10012040A Size: 1 1/2 in x 1 3/4 in x 6 in Rocker for TH913	65856	Consult
TH915	Equiv. Thurman no. T-11-1 Equiv. new Thurman no. 10012980A Size: 2 1/8 in x 1 in x 3 5/8 in long Bearing, fulcrum with straight shank Shank size: 11/16 in dia	65903	Consult
TH911	Equiv. Thurman no. T-12-1 Equiv. new Thurman no. 10005800A Size: 2 in x 1 in x 5 5/8 in long Bearing, fulcrum with straight shank Shank size: 11/16 in dia	65282	Consult
TH913	Equiv. Thurman no. T-979-1 Equiv. new Thurman no. 10008560A Size: 2 in x 1 1/4 in x 7 9/16 in long Bearing, fulcrum with straight shank Shank size: 11/16 in dia	65624	Consult
72192	Equiv. Thurman no. Size: 2 in x 1 in x 10 3/4 in no holes, fulcrum	66401	Consult

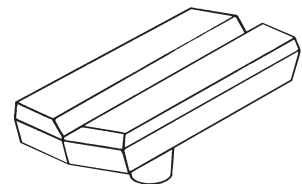
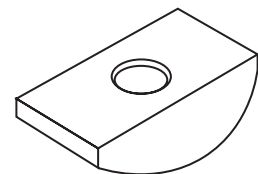
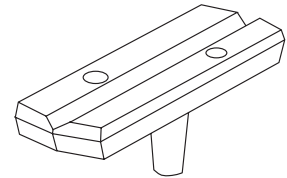

THURMAN®

Individual Thurman Scale Parts

Miscellaneous Diameter Balls, Plates & Stands

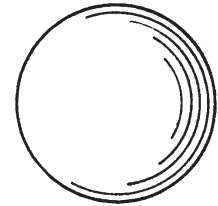

RL PN	DESCRIPTION	THURMAN NEW #	SUGG. LIST
18815	Equiv. Thurman no. 10000190A size: 5/8 in dia Ball, model 3300	64346	Consult
10993	Equiv. Howe no. n/a Size: 3/4 in dia Ball (steel)		Consult
18816	Equiv. Thurman no. 10001450A size: 7/8 in dia Ball, model 3500		Consult
10772	Equiv. Howe no. n/a Size: 1 in dia Ball (steel)		Consult
H648	Equiv. Howe no. 42035848 Size: 1 5/16 in dia Ball (steel) Models: 57, type 54, Floor scales etc.		Consult
TH927	Equiv. Thurman no. Equiv. new Thurman no. 10013810A Size: 1 7/16 in dia Ball, warehouse scale Model 3300, suspension	65929	Consult
H697	Equiv. Howe no. Size: 1 1/2 in dia Ball (steel)	64684	Consult
33645	Equiv. Thurman no. T-250 Equiv. new Thurman no. 10013950A size: 2 in dia Ball, truck scale	65930	Consult
H644	Equiv. Howe no. 42102471 Size: 2 3/8 in dia Ball (cast)		Consult
33646	Equiv. Thurman no. T-250-1 Equiv. new Thurman no. 10005830A size: 2 1/2 in dia Ball, truck scale	65294	Consult
33649	Equiv. Thurman no. T-251 Equiv. new Thurman no. 10012030A size: 3 in dia Ball, truck scale	65855	Consult
33648	Equiv. Thurman no. T-251-1 Equiv. new Thurman no. 10013960A size: 3 1/2 in dia Ball, truck scale	65931	Consult



THURMAN®

Individual Thurman Scale Parts

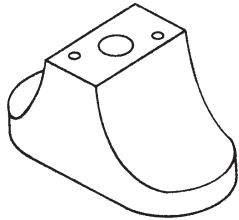
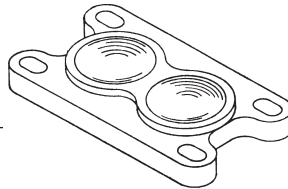
Miscellaneous Diameter Balls, Plates & Stands (Cont.)

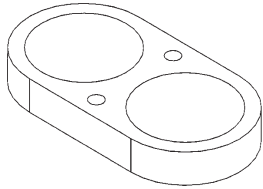
RL PN	DESCRIPTION	THURMAN NEW #	SUGG. LIST	
TH919	Equiv. Thurman no. T-270 Equiv. new Thurman no. 10005820A Size: 4 in x 4 in x 8 in long Ball stand, truck scale	65293	Consult	
TH948	Equiv. Thurman no. T-115 Equiv. new Thurman no. 10030540A Size: 5 in x 7 3/4 in x 11 in long Ball stand, 75-ton truck scale	72236	Consult	
33907	Equiv. Thurman no. T115-2 Equiv. new Thurman no. 10003970A Size: 5 in x 6 in x 11 in long Ball stand, class III & IV	64960	Consult	
TH918	Equiv. Thurman no. T-269, T1556 Equiv. new Thurman no. 10008690Y Size: 6 1/4 in x 1 1/4 in x 11 in long Ball plate, truck scale	65643	Consult	
TH947	Equiv. Thurman no. T-122-1 Equiv. new Thurman no. 10004080Y Size: 13 in x 2 1/4 in x 12 in long Ball plate, 75-ton truck scale		Consult	
75115	Equiv. Thurman no. T1626 Equiv. new Thurman no. 10004080Y Size: 8 in x 1 1/2 in x 13 in long Ball plate	72236	Consult	
33906	Equiv. Thurman no. n/a Equiv. new Thurman no. 10005860A Size: 4 1/4 in x 1 1/8 in x 8 1/4 in long Ball plate, model 8160 class I & II		Consult	
33905	Equiv. Thurman no. n/a Equiv. new Thurman no. 10048650A Size: 5 in x 1 1/2 in x 11 in long Ball plate, model 8160 class III & IV		Consult	

THURMAN®

Individual Thurman Scale Parts

Miscellaneous Parts

RL PN	DESCRIPTION	THURMAN NEW #	SUGG. LIST
TH950	Equiv. Thurman no. 10003190A size: 2 3/8 in dia x 14 in 50,000 And 60,000 lb Trunnion, electronic truck scales	64812	Consult
TH966	Equiv. Thurman no. 10003200A size: 2 3/4 in dia x 14 in 100,000 lb Trunnion, electronic truck scales	64814	Consult
65430	Equiv. Thurman no. 10018420A size: 1 1/4 in dia x 7 in inside dimensions Link, electronic truck scales	66347	Consult
21912	Equiv. Thurman no. 10003220A Size: 1 3/8 in dia x 7 3/4 in inside dimensions Link, electronic truck scales		Consult
33654	Equiv. Thurman no. 10000140A Size: A. 3/4 in C. 1/2 in B. 1 1/8 in D. 1/2 in-20 THrd Load cup Model 3500 1,000-5,000 lb, 1500/1502, 3300/3301 1,000-4,000 lb		Consult
33653	Equiv. Thurman no. 10001640A Size: A. 1 1/8 in C. 3/4 in B. 1 1/2 in D. 3/4 in-16 THrd Load cup Model 3510/3520 10,000 and 20,000 lb, 1500/1503, 5,000 and 10,000 lb	64554	Consult
33650	Equiv. Thurman no. Sp 10002400a Size: A. 1 3/4 in C. 13/16 in B. 2 13/16 in D. 1 in-14 THrd Load cup		Consult
33647	Equiv. Thurman no. Size: A. 1 3/4 in C. 1/2 in B. 2 3/4 in D. 1/2 in-20 THrd Load cup		Consult
TH952SS	Equiv. Thurman no. 10000170A Size: 0.783 in dia x 1/2 in Bearing socket		Consult
TH954SS	Equiv. Thurman no. 10001630A Size: 1.127 in dia x 3/4 in Bearing socket		Consult

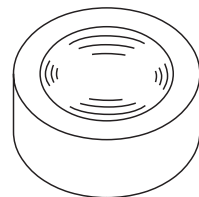
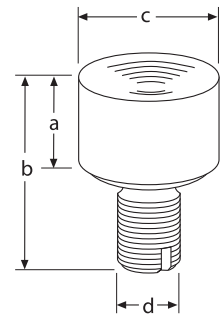
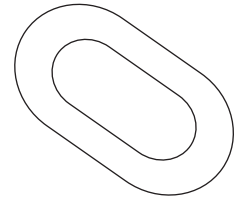
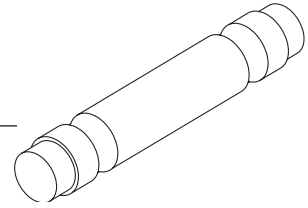

THURMAN KITS

THURMAN®

Thurman Kit Price Index By Rice Lake PN

RL PN	SUGG. LIST	PAGE #	RL PN	SUGG. LIST	PAGE #	RL PN	SUGG. LIST	PAGE #
34323	CONSULT	258	TH302K	CONSULT	261	TH309K	CONSULT	263
34324	CONSULT	258	TH303K	CONSULT	261	TH310K	CONSULT	XX
34325	CONSULT	258	TH304K	CONSULT	262	TH312K	CONSULT	XX
34326	CONSULT	259	TH306K	CONSULT	262	TH313K	CONSULT	XX
34327	CONSULT	259	TH307K	CONSULT	263	TH314K	CONSULT	262
34328	CONSULT	259	TH308K	CONSULT	263			
34329	CONSULT	260						
34330	CONSULT	260						
TH301K	CONSULT	261						

*Item obsolete or discontinued. When remaining stock is depleted, published prices are withdrawn and The item is subject to a special order quote.

XX Call for details.

THURMAN®

Mechanical Vehicle Scales

Models 8100 (XTCP), 8110 and 8120, (STCP), 8130 and 8140 (SAM)

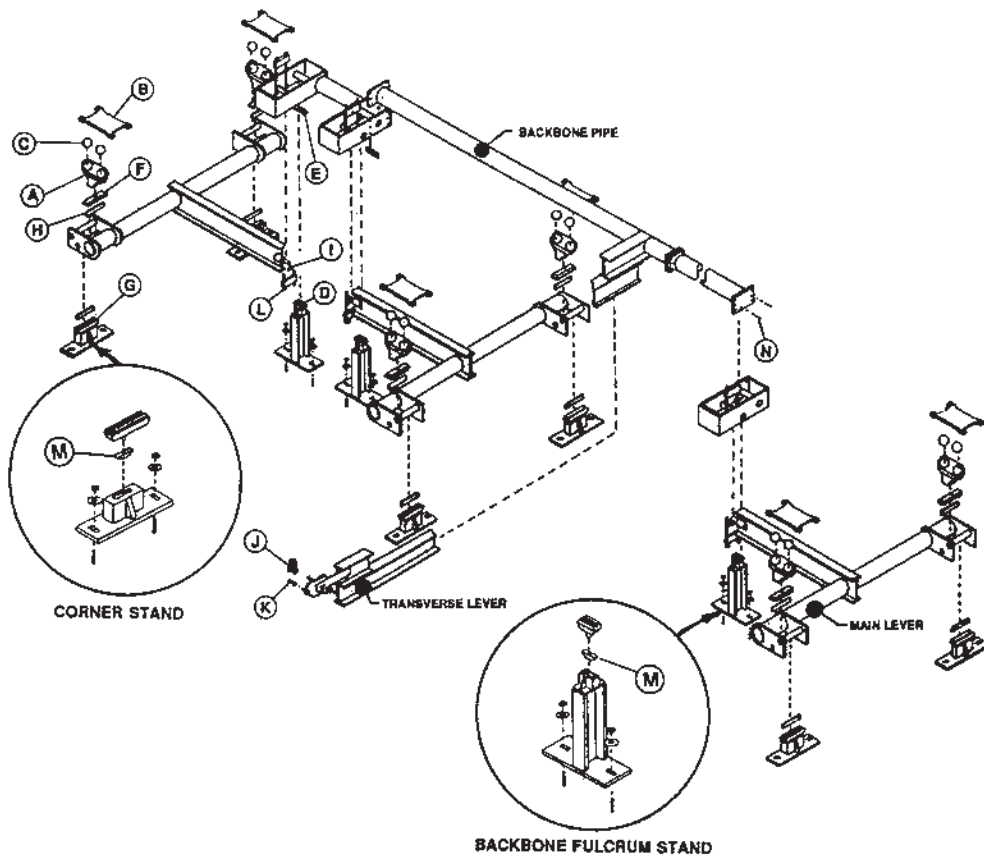

THURMAN®

Model 8160 Electro-mechanical

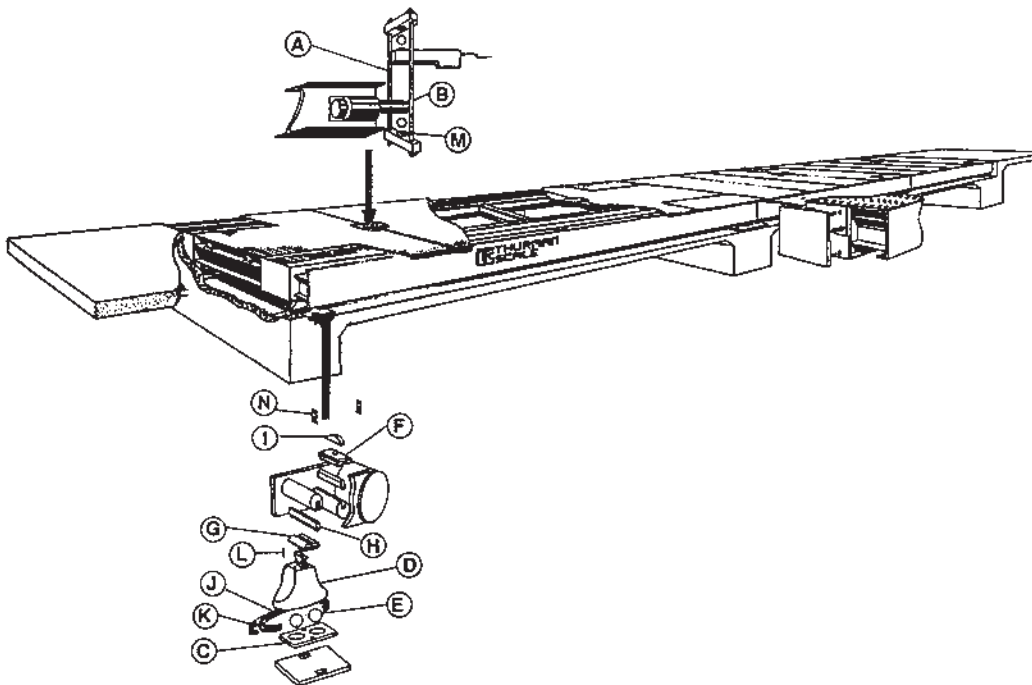

Truck Scale

Kit No. 34323 Thurman PN 96955

Pivot and Bearing Kit 2-Section, 1982 and Newer, Class III and IV

Model 8100 XTCP

Models 8110 and 8120 STCP

Models 8130 and 8140 SAM

QTY	RL PN	EQUIV. THURMAN #	DESCRIPTION
8.....	TH907P	T-1155-4, 10008490A	Pivot, load and fulcrum
4.....	TH912.....	T-979, 10008550A.....	Bearing, load
4.....	TH913.....	T-979-1, 10008560A...	Bearing and fulcrum
4.....	TH903P	T-1155, 10008590A.....	Pivot, torque tube load and fulcrum
4.....	TH970.....	T-1079-4, 10012040D	Rocker
2.....	TH915.....	T-11-1, 10012980A.....	Bearing, torque tube fulcrum
2.....	TH917.....	T-191	Bearing, torque tube load
2.....	TH916.....	T-192	Bearing, main lever, tip
2.....	TH901P	T255-1, 10008710A ...	Pivot, main lever tip
1.....	22910	10012770A.....	Pivot, transverse lever tip
8.....	15290	n/a.....	Pin, spring 3/8 in x 1 1/2 in

Consult Suggested list/80 lb shipping weight

Kit No. 34324 Thurman PN 96807

Suspension Kit, 2-Section, old scale use kit TH914K, 1982 and Newer Scale Use Class III and IV

Model 8100 XTCP

Models 8110 and 8120 STCP

Models 8130 and 8140 SAM

QTY	RL PN	EQUIV. THURMAN #	DESCRIPTION
8.....	33649	T251, 10012030a	Ball 3 inch
4.....	33907	T-115-2, 10003970a...	Tee block (ball stand) 6 inch high
4.....	75115	T-1626, 10004080y	Ball plate, <i>check height of tee block</i>

Consult Suggested list/350 lb shipping weight

Kit No. 34325 Thurman PN 34325

Pivot and Bearings Kit, 3-Section, 1982 and Newer Class I and II

Model 8100 XTCP

Models 8110 and 8120 STCP

Models 8130 and 8140 SAM

QTY	RL PN	EQUIV. THURMAN #	DESCRIPTION
12.....	TH905P	T-1155-2, 10005980A	Pivot, load and fulcrum
6.....	TH910.....	T-12, 10005850A.....	Bearing, load
6.....	TH911.....	T-12-1, 10005800A.....	Bearing, fulcrum
6.....	TH903P	T1155, 10008590A.....	Pivot, torque tube load and fulcrum
6.....	TH945.....	T675, 10005790A.....	Rocker
3.....	TH915.....	T11-1, 10012980A	Bearing, torque tube fulcrum
3.....	TH917.....	T191	Bearing, torque tube load
3.....	TH916.....	T192	Bearing, main lever tip
3.....	TH901P	T255-1, 1008710A	Pivot, main lever tip
1.....	22910	10012770A.....	Pivot, torque tube tip
12.....	15290	n/a.....	Pin, spring 3/8 in x 1 1/2 in

Consult Suggested list/90 lb shipping weight

Truck Scale

Kit No. 34326 Thurman PN 65811

Suspension Kit, 1982 and Newer, 3-Sections, Class I and II
 Model 8100 XTCP
 Models 8110 and 8120 STCP
 Models 8130 and 8140 SAM

QTY	RL PN	EQUIV. THURMAN #	DESCRIPTION
12.....	33646	T-250-1, 10005830A...	Balls, 2 1/2 inch
6.....	TH918.....	T-269, 10008690a	Ball plate
6.....	TH919.....	T-270, 10005820a	Tee block (ball stand)

Consult Suggested list/156 lb shipping weight

Kit No. 34327 Thurman PN 96956

Pivot and Bearing Kit, 3-Sections, 1982 and Newer Class III and IV
 Model 8100 XTCD
 Models 8110 and 8120 STCP
 Models 8130 and 8140 SAM

QTY	RL PN	EQUIV. THURMAN #	DESCRIPTION
12.....	TH907P	T115, 10008490A.....	Pivot, load and fulcrum
6.....	TH912.....	T979, 10008550a	Bearing, load
6.....	TH913.....	T-979-1, 10008560A...	Bearing, fulcrum
6.....	TH903P	TH1155, 10008590A ..	Pivot, torque tube load and fulcrum
6.....	TH970.....	T1079-4, 10012040A ..	Rocker
3.....	TH915.....	T11-1, 100012980A ...	Bearing, torque tube fulcrum
3.....	TH917.....	T191	Bearing, torque tube load
3.....	TH916.....	T192	Bearing, main lever tip
3.....	TH901P	T255-1, 10008710A ...	Pivot, main lever tip
1.....	22910	10012770A.....	Pivot, torque tube tip
12.....	15290	n/a.....	Pin, spring 3/8 in x 1 1/2 in

Consult Suggested list/105 lb shipping weight

Kit No. 34328 Thurman PN 96809

Suspension Kit, 3-Sections, 1982 and Newer Class III and IV
 Model 8100 XTCD
 Models 8110 and 8120 STCP
 Models 8130 and 8140 SAM

QTY	RL PN	EQUIV. THURMAN #	DESCRIPTION
12.....	33649	T251, 10012030A.....	Balls, 3 inch
6.....	33907	T-115-2, 10003970A...	Tee block (ball stand) 6 inch high
6.....	75115	T1626, 10004080A.....	Ball plate, <i>check height of tee block</i>

Consult Suggested list/527 lb shipping weight

THURMAN®

Truck Scale

Kit No. 34329 Thurman PN 96957

Pivot and Bearings Kit, 4-Sections, 1982 and Newer, Class III and IV

Model 8100 XTCD

Models 8110 and 8120 STCP

Models 8130 and 8140 SAM

QTY	RL PN	EQUIV. THURMAN #	DESCRIPTION
16.....	TH907P	T-1155-4, 10008490A	Pivot, load and fulcrum
8.....	TH912.....	T-979, 10008550A.....	Bearing, load
8.....	TH913.....	T-979-1, 10008560A...	Bearing, fulcrum
8.....	TH903P	T1155, 10008590A.....	Pivot, torque tube load and fulcrum
8.....	TH970.....	T1079-4, 100112040A	Rocker
4.....	TH915.....	T11-1, 10012980A	Bearing, torque tube fulcrum
4.....	TH917	T191	Bearing, torque tube load
4.....	TH916.....	T192	Bearing, main lever tip
4.....	TH901P	T255-1, 10008710A ...	Pivot, main lever tip
1.....	22910	10012770A.....	Pivot, torque tube tip
16.....	15290	n/a.....	Pin, spring 3/8 in x 1 1/2 in

Consult Suggested list/120 lb shipping weight

Kit No. 34330 Thurman PN 96808

Suspension Kit, 4-Sections, 1981 and Older Use Kit TH313K, 1982 and Newer Use This Kit, 34330

Model 8100 XTCD

Models 8110 and 8120 STCP

Models 8130 and 8140 SAM

QTY	RL PN	EQUIV. THURMAN #	DESCRIPTION
16.....	33649	T251, 10012030a	Balls, 3 inch
8.....	33907	T-115-2, 10003970a...	Tee block (ball stand) 6 inch high
8.....	75115	T1626, 10004080a.....	Ball plate, <i>check height of tee block</i>

Consult Suggested list/700 lb shipping weight

THURMAN®

Truck Scale

Kit No. TH301K

Pivot and Bearing Kit (Does Not Fit Side Arm), 2-Section, 27-Ton Light Duty

QTY	RL PN	EQUIV. THURMAN #	DESCRIPTION
4	TH914	T-11	Bearing, load
4	TH945	T675, 10005790A	Rocker
6	TH915	T-11-1	Bearing, fulcrum
12	TH904P	T-255	Pivot, load and fulcrum
2	TH916	T-192	Bearing, main lever tip
2	TH917	T-191	Bearing, torque tube load
2	TH901P	T-255-1	Pivot, tip
1	22910	10012770A	Pivot, transverse tip
16	15290	n/a	Roll pin

Consult Suggested list/45 lb shipping weight

Kit No. TH302K Thurman PN 72805

Pivot and Bearing Kit (Does Not Fit Side Arm), 2-Section, 27- and 37-Ton Heavy Duty Truck Scale

QTY	RL PN	EQUIV. THURMAN #	DESCRIPTION
4	TH910	T-12	Bearing, load
4	TH911	T-12-1	Bearing, fulcrum
4	TH945	T675, 10005790a	Rocker
8	TH905P	T-1155-2	Pivot, load and fulcrum
2	TH916	T-192	Bearing, main lever tip
2	TH917	T-191	Bearing, torque tube load
2	TH915	T-11-1	Bearing, torque tube fulcrum
2	TH901P	T-255-1	Pivot, tip
2	TH902P	T-1155-1	Pivot, torque tube load
2	TH904P	T-255	Pivot, torque tube fulcrum
1	TH922P	T-47-2	Pivot, transverse tip
8	15290	n/a	Roll pin

Consult Suggested list/53 lb shipping weight

Kit No. TH303K Thurman PN 65810

Suspension Kit, 2-Section, 27- and 37-Ton Light and Heavy Duty Truck Scales

QTY	RL PN	EQUIV. THURMAN #	DESCRIPTION
8	33646	T-250-1	Ball, 2 1/2 in
4	TH918	T-269	Ball plate
4	TH919	T-270	Tee block (ball stand)

Consult Suggested list/156 lb shipping weight

THURMAN®

Truck Scale

Kit No. TH304K

Pivot & Bearing Kit, 2-Section, 52-Ton Truck Scale

QTY	RL PN	EQUIV. THURMAN #	DESCRIPTION
4	TH913	T-979-1	Bearing, fulcrum
4	TH912	T-979	Bearing, load
4	TH970	T1079-4, 10012040A	Rocker
8	TH907P	T-1155-4	Pivot, load & fulcrum
2	TH911	T-12-1	Bearing, torque tube fulcrum
2	TH916	T-192	Bearing, main lever tip
2	TH917	T-191	Bearing, torque tube load
2	TH905P	T-1155-2	Pivot, torque tube fulcrum
2	TH903P	T-1155	Pivot, torque tube load
2	TH901P	T-255-1	Pivot, main lever tip
1	22910	10012770A	Pivot, transverse tip
8	15290	n/a	Roll pin

Consult Suggested list/72 lb shipping weight

Kit No. TH314K

Suspension Kit For 1981 and Older Use TH314K, Newer Scales Use Kit 34324

QTY	RL PN	EQUIV. THURMAN #	DESCRIPTION
8	33649	T-251	Ball, 3 in
4	TH947	T-122-1	Ball plate, <i>check height of tee block</i>
4	TH948	T-115	Tee block (ball stand) 7 3/4 in high

Consult Suggested list/390 lb shipping weight

Kit No. TH306K

Pivot & Bearing Kit, 4-Section, 52- & 62-Ton Truck Scale, Class I and II
 Model 8100 XTCD
 Models 8110 & 8120 STCP
 Models 8130 & 8140 SAM

QTY	RL PN	EQUIV. THURMAN #	DESCRIPTION
8	TH910	T-12	Bearing, load
8	TH911	T-12-1	Bearing, fulcrum
12	TH945	T675, 10005790A	Rocker
16	TH905P	T-1155-2	Pivot, load & fulcrum
4	TH916	T-192	Bearing, lower tip
4	TH917	T-191	Bearing, torque tube load
4	TH901P	T-255-1	Pivot, tip
4	TH902P	T-1155-1	Pivot, torque tube load
4	TH915	T-11-1	Bearing, torque tube fulcrum
4	TH904P	T-255	Pivot, torque tube fulcrum
1	22910	10012770A	Pivot, transverse tip
16	15290	n/a	Roll pin

Consult Suggested list/100 lb shipping weight

Truck Scale

Kit No. TH307K Thurman PN 65812

Suspension Kit For TH306K

QTY	RL PN	EQUIV. THURMAN #	DESCRIPTION
16.....	33646	T-250-1	Ball, 2 1/2 in
8.....	TH918.....	T-269	Ball plate
8.....	TH919.....	T-270	Tee block (ball stand)

Consult Suggested list/312 lb shipping weight

Kit No. TH308K

Pivot & Bearing Kit, 5-Section, 52- & 62-Ton Truck Scale

QTY	RL PN	EQUIV. THURMAN #	DESCRIPTION
10.....	TH910.....	T-12	Bearing, load
10.....	TH911.....	T-12-1	Bearing, fulcrum
10.....	TH945.....	T-675, 10005790A.....	Rocker
20.....	TH905P	T-1155-2.....	Pivot, load & fulcrum
5.....	TH916.....	T-192	Bearing, lower tip
5.....	TH917.....	T-191	Bearing, torque tube load
5.....	TH901P	T-255-1	Pivot, tip
5.....	TH915.....	T-11-1	Bearing, torque tube fulcrum
5.....	TH902P	T-1155-1.....	Pivot, torque tube load & fulcrum
1.....	22910	10012770A.....	Pivot, transverse tip
5.....	TH904P	T-255	Pivot, torque tube fulcrum
20.....	15290	n/a.....	Roll pin

Consult Suggested list/125 lb shipping weight

Kit No. TH309K

Suspension Kit For TH308K

QTY	RL PN	EQUIV. THURMAN #	DESCRIPTION
20.....	33646	T-250-1	Ball, 2 1/2 in
10.....	TH918.....	T-269	Ball plate
10.....	TH919.....	T-270	Tee block (ball stand)

Consult Suggested list/390 lb shipping weight

THURMAN®

Truck Scale

Kit No. TH310K

Pivot & Bearing Kit, 4-Section, 75-Ton Truck Scale

QTY	RL PN	EQUIV. THURMAN #	DESCRIPTION
8.....	TH912.....	T-979	Bearing, load
8.....	TH913.....	T-979-1	Bearing, fulcrum
8.....	TH970.....	T1079-4, 10012040A	rocker
16.....	TH907P	T-1155-4.....	Pivot, load & fulcrum
4.....	TH916.....	T-192	Bearing, main lever tip
4.....	TH911	T-12-1	Bearing, torque tube
4.....	TH905P	T-1155-2.....	Pivot, torque tube fulcrum
4.....	TH903P	T-1155	Pivot, torque tube load
4.....	TH901P	T-255-1	Pivot, main lever tip
4.....	TH917	T-191	Bearing, torque tube
1.....	22910	10012770A.....	Pivot, transverse tip
16.....	15290	n/a.....	roll pin

Consult Suggested list/143 lb shipping weight

Kit No. TH313K

Suspension Kit For TH310K Built Before 1982 For Scales Built After 1982 Use Kit 34330

QTY	RL PN	EQUIV. THURMAN #	DESCRIPTION
8.....	TH947.....	T-122-1	Ball plate
8.....	TH948.....	T-115	Tee block, 7 3/4 in tall
16.....	33649	T-251	Ball, 3 in

Consult Suggested list/777 lb shipping weight

Kit No. TH312K

Straight Lever, 4-Section, 50- & 75-Ton Truck Scale

QTY	RL PN	EQUIV. THURMAN #	DESCRIPTION
40.....	TH914.....	T-11	Bearing, load & fulcrum
32.....	TH904P	T-255	Pivot, load & fulcrum
14.....	TH901P	T-255-1	Pivot, tip
14.....	TH916.....	T-192	Bearing, tip
12.....	TH917	T-191	Bearing, torque tube
8.....	TH903P	T-1155	Pivot, extension lever
12.....	TH902P	T-1155-1.....	Pivot
1.....	22910	10012770A.....	Pivot, tip

Consult Suggested list/172 lb shipping weight

Call 715-234-9171 For Suspension Parts