

# MSI-4260

*Port-A-Weigh Crane Scales*

## Technical Manual



© Rice Lake Weighing Systems. All rights reserved.

Rice Lake Weighing Systems® is a registered trademark of  
Rice Lake Weighing Systems.

All other brand or product names within this publication are trademarks or  
registered trademarks of their respective companies.

All information contained within this publication is, to the best of our knowledge, complete and  
accurate at the time of publication. Rice Lake Weighing Systems reserves the right to make  
changes to the technology, features, specifications and design of the equipment without notice.

The most current version of this publication, software, firmware and all other product  
updates can be found on our website:

[www.ricelake.com](http://www.ricelake.com)

# Revision History

---

This section tracks and describes manual revisions for awareness of major updates.

Revision	Date	Description
A	February 27, 2023	Initial manual release with product launch
B	December 13, 2023	Added replacement parts diagrams
C	February 26, 2025	Updated specifications

*Table i. Revision Letter History*



Technical training seminars are available through Rice Lake Weighing Systems. Course descriptions and dates can be viewed at [www.ricelake.com/training](http://www.ricelake.com/training) or obtained by calling 715-234-9171 and asking for the training department.

# Contents

<b>1.0</b>	<b>Introduction</b>	<b>7</b>
1.1	Features	7
1.2	FCC Compliance	7
1.3	Disposal	7
1.4	Safety	8
1.5	Display	9
1.5.1	Keypad Functions	9
1.5.2	Annunciators and LEDs	10
<b>2.0</b>	<b>Installation</b>	<b>11</b>
2.1	Unpacking	11
2.2	Battery Pack	11
2.2.1	Battery Life	11
2.2.2	Battery Charger	12
2.2.3	Battery Replacement	13
2.3	Communications Port	14
2.4	Servicing	15
2.4.1	Remove Front Casting	15
2.4.2	Reinstall Front Casting	15
<b>3.0</b>	<b>Operation</b>	<b>17</b>
3.1	Power	17
3.2	Zero	17
3.3	Tare	17
3.3.1	View Tare	18
3.3.2	Clear Tare	18
3.4	Function Key	18
3.4.1	Test	18
3.4.2	Total	19
3.4.3	View Total	19
3.4.4	Net / Gross	19
3.4.5	Peak Hold	20
3.4.6	Units	20
3.4.7	High Resolution Test Mode	20
3.4.8	Print	20
<b>4.0</b>	<b>Setup</b>	<b>21</b>
4.1	Setup Menu	21
4.2	Set Function Key	22
4.3	Auto-Off	22
4.4	Sleep	23
4.5	Display Brightness	23
4.6	Display Color	24
4.7	Setpoints	24



Rice Lake continually offers web-based video training on a growing selection of product-related topics at no cost. Visit [www.ricelake.com/webinars](http://www.ricelake.com/webinars)

4.8	Total	25
4.9	Filter Setup	26
4.10	Unit	27
4.11	Battery Life	27
<b>5.0</b>	<b>Calibration</b>	<b>28</b>
5.1	Calibration Switch Access	28
5.2	Standard Calibration	29
5.3	Initial Calibration	30
5.4	Guidelines for Capacity and Resolution	31
5.4.1	Capacity	31
5.4.2	Resolution	31
5.5	C-Cal Calibration	32
5.6	Calibration Setup Menu	33
5.7	Auto Zero Maintenance	34
5.8	Filter	34
5.9	Gravity Compensation	35
5.9.1	Compensation by Latitudes and Elevations	35
5.9.2	Compensation by Gravity Factor	36
<b>6.0</b>	<b>Communications</b>	<b>37</b>
6.1	Communications Setup	37
6.2	Printer and Serial Output Setup	37
6.2.1	Standard Print Strings	38
6.2.2	Control Modes	38
6.2.3	Printer Output Setup	39
6.2.4	Custom Print Formatters	39
6.3	RF Network Setup	40
6.3.1	802.15.4 RF Network Setup	40
6.3.2	Hold Feature	42
6.4	Radio Compliance	42
6.4.1	802.15.4 (XBee 3 and XBee 3-PRO)	42
6.4.2	802.15.4 (XBee 2SC)	43
6.4.3	Wi-Fi	43
6.4.4	Bluetooth	43
6.4.5	FHSS (Frequency Hopper Spread Spectrum)	43
<b>7.0</b>	<b>Optional Rugged Remote</b>	<b>44</b>
7.1	Operation	44
7.1.1	Power	45
7.1.2	Zero	45
7.1.3	Tare	45
7.1.4	Programmable Function Keys	45
7.2	Conflict and Jamming Considerations	45
7.3	FCC Compliance	45



Technical training seminars are available through Rice Lake Weighing Systems. Course descriptions and dates can be viewed at [www.ricelake.com/training](http://www.ricelake.com/training) or obtained by calling 715-234-9171 and asking for the training department.

**8.0 Troubleshooting/Maintenance** ..... **46**  
    8.1 Service Counters..... 47  
    8.2 MSI-4260C Dimensions ..... 48  
**9.0 Specifications** ..... **49**



*Rice Lake continually offers web-based video training on a growing selection of product-related topics at no cost. Visit [www.ricelake.com/webinars](http://www.ricelake.com/webinars)*

# 1.0 Introduction

This manual is intended for use by service technicians responsible for installing and servicing the MSI-4260 Port-A-Weigh. Configurations and calibration of the scale can be accomplished using ScaleCore Connect software, RF remote control, RF remote displays, or the front panel keys. See [Section 4.0 on page 21](#) and [Section 5.0 on page 28](#) for information about setup and configuration of the MSI-4260.



Manuals are available from Rice Lake Weighing Systems at [www.ricelake.com/manuals](http://www.ricelake.com/manuals)

Warranty information is available at [www.ricelake.com/warranties](http://www.ricelake.com/warranties)

## 1.1 Features

- Automatic power off
- Automatic sleep mode
- The buttons are sealed and rated for over 1 million operations
- Precise high resolution (2500 division standard and up to 10,000 possible) 24 bit A/D conversion coupled with advanced RISC micro controller
- five large, 1.2" (30 mm) LED digits displayed in red, green or orange
- Full digital calibration
- Can be calibrated without test weights using C-Cal technology
- Selectable for kg/lb unless prohibited by Legal-for-Trade regulations
- Automatic or manual weight totalization
- High speed Peak mode
- Eight setpoints
- ScaleCore technology
- Two service counters

## 1.2 FCC Compliance

### United States

This equipment has been tested and found to comply with the limits for a Class A digital device, pursuant to Part 15 of the FCC Rules. These limits are designed to provide reasonable protection against harmful interference when the equipment is operated in a commercial environment. This equipment generates, uses and can radiate radio frequency energy and, if not installed and used in accordance with the instruction manual, may cause harmful interference to radio communications. Operation of this equipment in a residential area is likely to cause harmful interference in which case the user will be required to correct the interference at his own expense.

### Canada

This digital apparatus does not exceed the Class A limits for radio noise emissions from digital apparatus set out in the Radio Interference Regulations of the Canadian Department of Communications.

Le présent appareil numérique n'émet pas de bruits radioélectriques dépassant les limites applicables aux appareils numériques de la Class A prescrites dans le Règlement sur le brouillage radioélectrique édicté par le ministère des Communications du Canada.

## 1.3 Disposal



### Product Disposal

The product must be brought to appropriate separate waste collection centers at the end of its life cycle.

Proper separate collection to recycle the product helps prevent possible negative effects on the environment and to health, and promotes the recycling of the materials. Users who dispose of the product illegally shall face administrative sanctions as provided by law.

## Battery Disposal

Dispose of batteries at appropriate waste collection centers at the end of their life cycle in accordance with local laws and regulations. Batteries and rechargeable batteries may contain harmful substances that should not be disposed of in household waste. Batteries may contain harmful substances including but not limited to: cadmium (Cd), lithium (Li), mercury (Hg) or lead (Pb). Users who dispose of batteries illegally shall face administrative sanctions as provided by law.



**WARNING:** Risk of fire and explosion. Do not burn, crush, disassemble or short-circuit lithium batteries.

## 1.4 Safety

### Safety Definitions:



**DANGER:** Indicates an imminently hazardous situation that, if not avoided, will result in death or serious injury. Includes hazards that are exposed when guards are removed.



**WARNING:** Indicates a potentially hazardous situation that, if not avoided, could result in serious injury or death. Includes hazards that are exposed when guards are removed.



**CAUTION:** Indicates a potentially hazardous situation that, if not avoided, could result in minor or moderate injury.



**IMPORTANT:** Indicates information about procedures that, if not observed, could result in damage to equipment or corruption to and loss of data.

## General Safety



Do not operate or work on this equipment unless this manual has been read and all instructions are understood. Failure to follow the instructions or heed the warnings could result in injury or death. Contact any Rice Lake Weighing Systems dealer for replacement manuals.



### WARNING

Failure to heed could result in serious injury or death.

Do not allow minors (children) or inexperienced persons to operate this unit.

Do not stand near the load being lifted as it is a potential falling hazard. Keep a safe distance.

Do not use for purposes other than weight taking or dynamic load monitoring.

Do not use any load bearing component that is worn beyond 5% of the original dimension.

Do not use the scale if any of the components of the load train are cracked, deformed or show signs of fatigue.

Do not exceed the rated load limit of the scale, rigging elements or the lifting structure.

Do not allow multi-point contact with the hook, shackle or lifting eye of the scale.

Do not allow high torque on the scale unless it is specifically designed for high torque.

Do not make alterations or modifications to the scale or associated load bearing devices.

Do not use improperly rated or sized shackles. Use only Rice Lake Weighing Systems' recommended shackles.

Do not remove or obscure warning labels.

Do not submerge to clean.

For guidelines on safe rigging and loading of overhead scales and dynameters, read the MSI Crane Scale Safety and Periodic Maintenance Manual (available at [www.ricelake.com](http://www.ricelake.com)).

Keep hands, feet and loose clothing away from moving parts.

There are no user serviceable parts within the MSI-4260. Any repairs are to be performed by qualified service personnel only.

The MSI-4260 Port-A-Weigh scale has a safe mechanical overload of 200% and an ultimate overload of 500%. Overloads greater than 500% could result in structural failure and dropped loads. Dropped loads could cause serious personal injury or death.



## 1.5 Display

The keys and display of the MSI-4260 front panel is described below.



Figure 1-1. MSI-4260 Front Panel

### 1.5.1 Keypad Functions

The functions of the push buttons vary based on the current MSI-4260 mode.

Key		Weigh Mode	Setup Menu Navigation	Numeric Entry
	Power Key	Turns the MSI-4260 On and Off	Exits setup without saving changes; <code>ENTER</code> displays momentarily and unit enters <b>Weigh</b> mode	Enters decimal point to the left of the blinking digit
	Zero Key	Zeros out residual weight on the scale	Saves and drops back one menu level; At the root menu level the Zero key stores the changes and returns to Weigh mode <code>STORE</code> displays briefly	Steps back one digit to change or correct the digit to the left
	Tare Key	Removes the weight of containers, trucks or carriers and places the scale in the Net Weigh mode	Functions as the Enter/Select key	Confirms blinking digit and move to the digit to the right
	User Key	Programmable to user selectable functions ( <a href="#">Section 4.0 on page 21</a> ); This key is defaulted to the Test function	Functions as the Scroll key	Cycles blinking digit through numbers 0-9

Table 1-1. Key Functions

Example of numeric entry: Enter 2500 kg on a 5000 kg capacity scale.

- Press two times for the leftmost blinking digit, press to save that digit selection.
- Press five times for the next blinking digit, press to save that digit selection.
- Press to save that digit selection.
- Press to save the next digit selection. `2500` displays.

## 1.5.2 Annunciators and LEDs

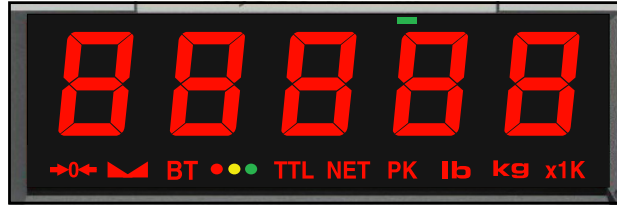

Figure 1-2. Front Panel

Annunciator	Name	Description
→0←	Center of Zero	Indicates that the scale is zeroed and the weight is within 1/4d of zero
▲▲	Stable	Indicates that the weight has settled within the motion window (usually $\pm 1d$ ); When this symbol is off, the scale will not zero, tare or totalize
BT	Low Battery	Displays when 10% of battery life remains; LED blinks indicating automatic shutdown will occur
● ● ●	Setpoints	Eight user programmable setpoints for early overload warnings; Red LED = Setpoint 1, Yellow LED = Setpoint 2, Green LED = Setpoint 3
TTL	Total	Blue LED indicates the total weight displays for five seconds or less
NET	Net	Indicates the scale is in Net mode; Tare weight has been subtracted from the gross weight
PK	Peak	Indicates the scale is in Peak Hold mode
lb	LB	Red LED indicates weight display is in pounds
kg	KG	Red LED indicates weight display is in kilograms
x1K	x1000	Indicates weight display or accumulation beyond the 5 digit display limit by a multiplier of 1000; If 1K is illuminated, read the total as the displayed value multiplied by 1000
■	Acknowledge	Green LED provides feedback to the operator that incoming remote commands have been received
88888	Display	The main display digits include five, 1.2" (30 mm) brightness LED load display; Main display may be red, orange, or green depending on the color setting

Table 1-2. Annunciators and LEDs



**WARNING:** Wear appropriate hearing protection when any audible alarm is active. Not wearing appropriate hearing protection may result in hearing loss.

## 2.0 Installation

The MSI-4260 cast aluminum enclosure is rated at NEMA Type 4 IP 66. It hangs from a crane using properly sized shackles.



**WARNING:** Refer to the *Crane Scale Safety and Periodic Maintenance Manual (PN 153105)* for safe loading and rigging guidelines when installing the model MSI-4260.

*Regular maintenance inspections of the lifting system should be performed to ensure safety. Pay particular attention for signs of stress on any element in the load train.*

Use the appropriate interface hardware for the capacity of the scale.

- If the interface hardware does not fit properly, Rice Lake Weighing Systems can supply the MSI-4260 with oversized lifting eyes or shackle interfaces.
- If the crane hook is too large to fit in the lifting eye with single point interface, then install the scale using adaptive rigging.
- If multiple attachments are needed, use a shackle or ring to attach multiple lines to keep a single point attachment to the scale.



**IMPORTANT:** Using an oversized shackle or hook to interface with the MSI-4260 can cause off center loading and stress points that will reduce the life of the lifting eye or hook.

*Single point attachments are necessary to ensure the safety and accuracy of the scale system.*

### 2.1 Unpacking

When unpacking the MSI-4260, ensure that all assembly parts are accounted for. Check the MSI-4260 for any visible damage. If any parts were damaged in shipment, notify Rice Lake Weighing Systems and the shipper immediately. If the MSI-4260 must be returned, it must be properly packed with sufficient packing materials. Whenever possible, use the original carton when shipping the unit back.

### 2.2 Battery Pack

The MSI-4260 is powered by a 12V Sealed Lead Acid (SLA) rechargeable battery. This battery operates for up to 100 hours (depending on LED brightness setting) before requiring recharging. Charging time for a completely discharged battery is up to eight hours. A spare battery pack is recommended to keep the MSI-4260 in continuous operation.



**IMPORTANT:** To obtain maximum service life from batteries, store between  $-4^{\circ}\text{F}$  and  $122^{\circ}\text{F}$  ( $-20^{\circ}\text{C}$  and  $+50^{\circ}\text{C}$ ).

*Stored batteries should be recharged every three months. The battery is fully charged when the status indicator on the battery charger flashes.*

#### 2.2.1 Battery Life

The battery life of the MSI-4260 depends on several factors:

- LED display brightness and number of segments lit
- RF activity
- Battery age
- SLA battery condition

The MSI-4260 includes the following power saving features:

- Automatic Power Off mode — Senses no activity after the set amount of minutes and turns the scale off
- Automatic Sleep mode — Dims the display after a set amount of minutes of no scale activity

The MSI-4260 automatically turns off when the SLA battery drops to approximately 10.5V. Recharge the battery when this happens, SLA batteries benefit from frequent recharging and can be recharged when it still has available life.

Due to the maintenance discharge imposed on the battery by the MSI-4260 electronics, do not store the MSI-4260 with the battery inside. Remove the battery if it will not be used for more than two weeks.



**IMPORTANT:** Leaving a discharged battery in the scale, which has a maintenance battery drain, can result in a deep discharged battery which will shorten its service life.

**NOTE:** If the scale is in continuous use, a fully charged spare battery is recommended. Replace the drained battery as close as possible to the low battery warning.

SLA batteries that have not been deep discharged should withstand 500 to 1500 charging cycles.

Low battery warning annunciator indicates about two to four hours of use before MSI-4260 powers off.

If the MSI-4260 is not going to be used again soon, remove SLA battery to prevent deep discharge while unit is in storage.

Recycle the battery at an authorized recycling center when the average life drops to 20 hours or less.

## 2.2.2 Battery Charger

The MSI-4260 is shipped with a battery charger designed to charge and maintain the battery. Exact charging time depends on the degree of battery discharge. A battery removed when the low battery warning first appears should take about four hours to fully charge.

**DANGER:** Charger is for indoor use only and should not be used in wet locations.

**NOTE:** When the battery is new, it might take significantly longer for the initial charge. It is recommended to charge a new battery for 24 hours. It might take several charge/discharge cycles before full capacity is reached. Deep discharged batteries also take significantly longer to charge.

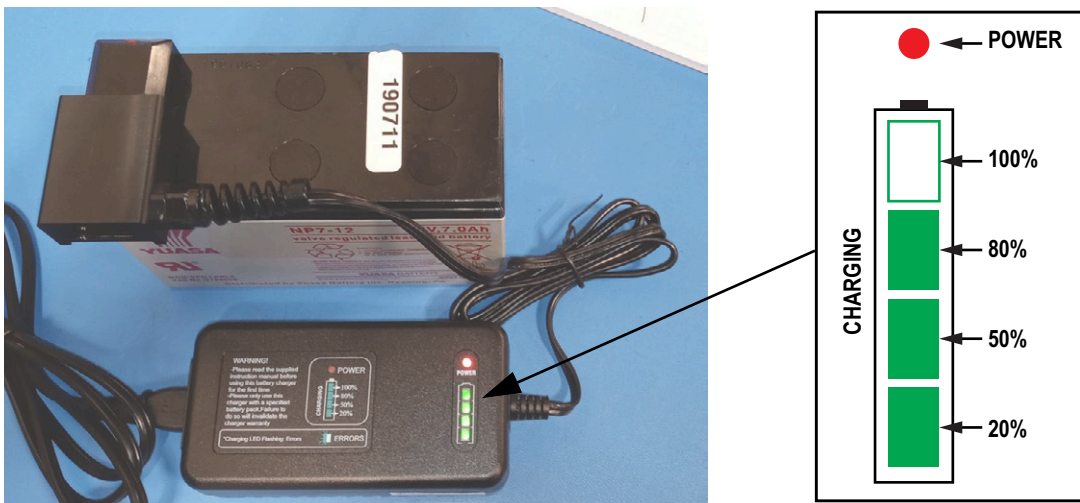

Figure 2-1. Battery Charger Connected to Battery

The battery charger illuminates annunciators as the battery charges. To charge the battery:

1. Remove the battery from the MSI-4260 (Figure 2-2 on page 13).
2. Connect the charger assembly to the AC power supply (86-260 VAC). The power annunciator displays red.

**NOTE:** If the power status light fails to illuminate, check the AC power connection to ensure the jack is fully seated. AC power cords suitable for any world location are available from Rice Lake Weighing Systems.

3. Plug the polarized connector into the jacks on the battery. Charging annunciators illuminate to represent charge percentage.
4. Charge until all status annunciators fully illuminate.

When the charge cycle is complete, the battery can be left on the charger until it is needed. The charger keeps a maintenance float charge on the battery to ensure the best possible operation times.

**IMPORTANT:** For maximum service life from batteries, the manufacturer suggests recharging after each 20 hours of use. Continuous deep discharging reduces maximum battery life cycle.

### 2.2.3 Battery Replacement

1. Turn the MSI-4260 off.
2. Secure the battery cover.
3. Release the latches holding the battery cover.
4. Slowly lower the cover while holding the battery in place.
5. Remove the battery by pulling straight back.
6. Install a fully charged battery by plugging it into the exposed battery jacks.
7. Close the battery cover.
8. Reset the latches. Ensure the latches are secured and the cover is firmly in place.



Figure 2-2. Remove Battery



**IMPORTANT:** Periodically, inspect the battery latches for fit. Adjust the screw latch by rotating the catch on its threads to maintain a tight seat on the battery O-ring.



**CAUTION:** The 12V Sealed Lead Acid battery can be a dangerous falling hazard. When opening the battery hatch, be sure to hold the battery to prevent it from falling. The batteries contain lead and should be recycled when they have reached their end of life.

## 2.3 Communications Port

The MSI-4260 has a single communications port allowing access to the embedded ScaleCore through the terminal access mode or ScaleCore Connect. The terminal access mode is used for updating scale firmware while ScaleCore Connect can be used for calibration and configuration, backup and adjusting scale settings. This communications port is not intended for output use.

The MSI-4260 comes standard with one communications port cable wired for RS-232 following the AT standard for 9-pin serial cables (DCE). An un-terminated cable is also available for wiring the serial cable for RS-232.

Table 2-1 shows the wiring color code.

Signal	Wire Color
TxD (transmitted data)	Brown
RxD (received data)	Black
CTS (clear to send)	Gray
RTS (request to send)	White
GND (ground)	Blue
PG (protective ground)	Drain Wire

Table 2-1. RS-232 Wiring Code

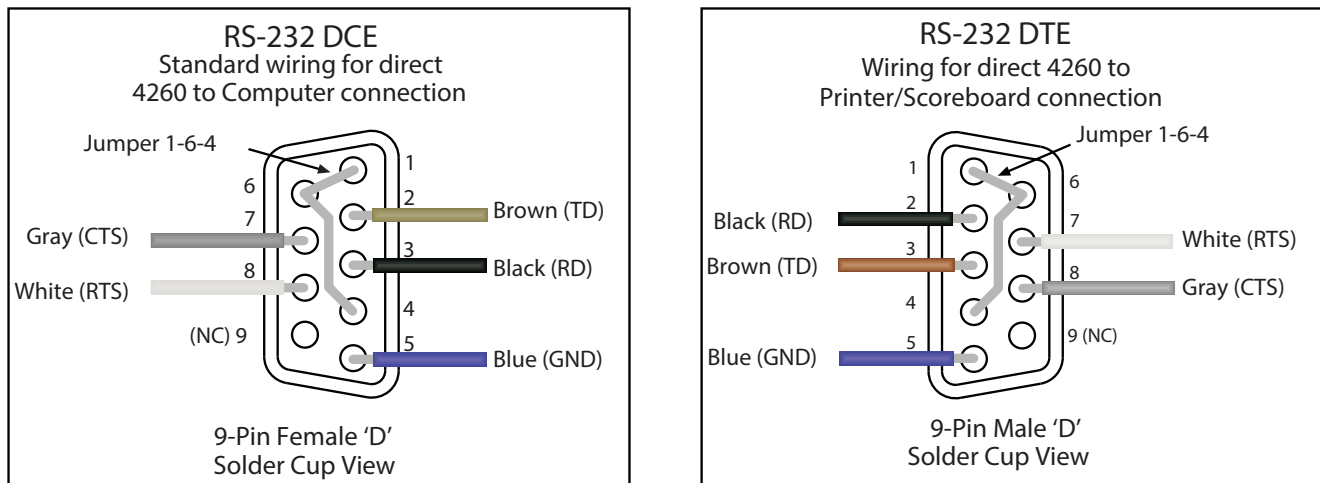

Figure 2-3. Comm Port Cable Assignments Examples

## 2.4 Servicing

Rice Lake Weighing System's dealer network provides both on-site and depot servicing of MSI-4260 crane scales. Please contact a local dealer or Rice Lake Weighing Systems to obtain a return material authorization (RMA). Due to the weight and size of many products, it is not always necessary to return the whole scale. Lower swivel hook assemblies and upper lifting shackles on 50k capacity models and above do not need to be returned for service or recalibration. There are no user serviceable parts inside the MSI-4260. Depot repair is performed with module and harness swaps. If the electronics are at fault, often the front casting section is all that needs to be returned.



Figure 2-4. Remove Front Casting

### 2.4.1 Remove Front Casting

See the following procedure to remove the front casting:

1. Remove the cap screws (x4).
2. Unplug connectors.
3. Package the front casting well for safe shipping.

### 2.4.2 Reinstall Front Casting

See the following procedure to reinstall the front casting:

1. Clean the front casting and bulkhead o-ring grooves with isopropyl alcohol.
2. Reconnect the load cell cables and power cables then tighten the cables.
3. While securing the o-ring, ensure the o-ring is flush with the o-ring grooves.



**WARNING:** Replace damaged o-rings when necessary. Damaged o-rings may break the unit seal, allowing water penetration.

4. Insert the bolts (x4) into the front casting then torque the bolts to 20–25 ft-lbs.



**NOTE:** Apply anti-seize compound as necessary.

## 3.0 Operation

The following sections describe the Weigh mode operation of the MSI-4260.

### 3.1 Power

The power key turns the MSI-4260 power on. While in Weigh mode, it also turns the power off.

Press  to turn on the power. The following sequence displays:

1. All LED segments light at full brightness as a display test.
2. 50Ft displays, followed by the software version number.
3. 57RNd followed by the weighing standard.
4. bREt displays, followed by the battery voltage.
5. d.t.E5t displays, followed by the display counting from 00000 to 99999.
6. C - CRL displays, followed by the C-CAL value.
7. MSI-4260 enters Weigh mode.

While in Weigh mode, press  to turn off the power.



**IMPORTANT:** The scale has a maintenance battery drain. Always remove the battery if the scale will be off for an extended period of time. Leaving a discharged battery in the scale can result in a deep discharged battery which will shorten its service life.

### 3.2 Zero

The zero key sets the zero reading of the scale.

Press  to remove small deviations in zero when the scale is unloaded. For zeroing (taring) package or pallet weights, see [Section 3.3](#). The zero key can be used in **GROSS** or **NET** mode.



**NOTE:** The backup memory in the unit stores the zero reading and retains it even if the power fails.

Zeroing while in **NET** mode will zero the **GROSS** weight causing the display to show a negative tare value.

The scale must be stable within the stable window.

The unit will only zero if  is on and there has been no activity for two seconds. If a motion ceases within the motion window in that time, the scale will zero.

The scale will accept a zero setting over the full range of the scale (NTEP and other Legal for Trade models may have a limited zero range).



Zero settings above 4% of full scale will subtract from the overall capacity of the unit.

*Example: If 100 lb on a 1,000 lb scale is zeroed, the overall capacity of the scale will reduce to 900 lb, plus the allowed over-range amount.*

### 3.3 Tare

Tare is used to zero out a known weight, such as a packing container or pallet, and display a **NET** weight. The **TARE** function is defined as a **Tare-In** or **Tare-Out** operation.

To tare the scale:

1. Hang the empty container from the scale.
2. Press  to enter a tare value. The MSI-4260 stores the current weight as a tare value and subtracts the value of the container from the **GROSS** weight.  displays and the Weigh mode changes to **NET**.
3. Add the product to the packing container. The **NET** weight displays.





**NOTE:** To set a new tare, the existing tare must first be cleared. The MSI-4260 will not set a new tare over an old tare.



### 3.3.1 View Tare

To view the **GROSS** weight without clearing the tare value:

1. Program  to the **NET/GROSS** function ([Section 4.2 on page 22](#)).
2. Press  to toggle between **NET** and **GROSS** values. This will only work if a tare value has been established.



**NOTE:** The backup memory in the MSI-4260 stores the Tare reading and can restore it even if power fails.

Only positive **GROSS** weight readings can be tared. The **STABLE** annunciator must be on, indicating weight reading is stable. Setting or changing the tare has no effect on the **GROSS** zero setting. Taring will reduce the apparent over range of the scale. The **RF Remote Control** has **NET/GROSS** permanently available.

*Example: Taring a 100 lb container on a 1,000 lb scale, the scale will overload at a NET weight of 900 lb (1,000-100) plus any additional allowed overload (usually 4% or 9d).*

### 3.3.2 Clear Tare

To clear a saved tare value, press . The **GROSS** weight displays.



**NOTE:** Only positive gross weight readings can be tared.

The  must be off indicating weight reading is stable.

Setting or changing the tare has no effect on the gross zero setting.

Taring will reduce the apparent over-range of the scale.

The scale stores the tare value in non-volatile memory and is restored when power is cycled.

*Example: Taring a 100 lb container on a 1000 lb scale, the scale will overload at a net weight of 900 lb (1000-100) plus any additional allowed overload (usually ~4% or 9d).*

## 3.4 Function Key

The  key can be programmed in the setup menu ([Section 4.2 on page 22](#)) to one of the following functions. Some functions require additional programming in the setup menu to work correctly.

### 3.4.1 Test

When the  key is programmed to **TEST** ([Section 4.2 on page 22](#)), pressing the key prompts the scale to scroll through the following sequence and returns to Weigh mode:

1. All LED lights display momentarily at once.
2. **SOF** displays, followed by the software version number.
3. **SRAD** followed by the weighing standard
4. **bRE** displays, followed by the battery voltage.
5. **d.EE** displays, followed by the display counting from 00000 to 99999.
6. **C - CAL** displays, followed by the C-CAL value.



**NOTE:** Other internal tests are performed and if any test fails, an error code displays. See [Section 8.0 on page 46](#) for information on the troubleshooting guide.





### Automatic Scroll Test

- Press  to start the test



The unit automatically scrolls through the test sequence and returns to Weigh mode

## Single Step Test Mode

To stop the automatic scroll of the test procedure, begin the automatic scroll test and press  again within two seconds to enable a single step test mode.

1. Press  to scroll through the available test functions.
2. Press  to start or display the individual tests.
3. Press  to exit individual tests.
4. Press  to exit from the test function.

### 3.4.2 Total

When the  key is programmed to TOTAL (Section 4.2 on page 22), pressing the key prompts the scale to perform the total function that has been set in the setup menu. That can be, OFF, TARE, R.LOARD, R.LAST, or R.HIGH. For more information on these parameters and setup see Section 4.8 on page 25. If nothing has been set, nothing will happen when  is pressed.



- Press  to start the complete the total function



**NOTE:** The Total mode must be programmed from the Setup menus before the USER key will function.

### 3.4.3 View Total

When the  key is programmed to V-TOTAL (Section 4.2 on page 22), pressing the key prompts the scale to display total weight followed by the number of samples that have been saved.

1. Press  to display the total weight.
2. With the Total weight displayed, press  to clear.

### 3.4.4 Net / Gross

When the  key is programmed to NET/GROSS (Section 4.2 on page 22), pressing the key prompts the scale to switch the display between **NET** and **GROSS** modes. This will only work if a tare value has been established.

- Press  to toggle between NET and GROSS modes

**NET** weight is defined as **GROSS** weight minus a tare weight.

The operator can switch back to **GROSS** from **NET** without clearing the tare value. Only clearing or setting a new tare will change the tare value held before switching into **GROSS** mode.



**NOTE: OIML Legal for Trade units only:** The NET/GROSS key is a temporary action only. The GROSS weight displays for two seconds and then the display returns to the NET mode. The only way to return to permanent GROSS readings is to clear the tare (Section 3.3.2 on page 18).

### 3.4.5 Peak Hold

When the  key is programmed to *P-HLD* (Section 4.2 on page 22), pressing the key clears and re-enables the scale to only update the display when a higher weight reading is established. The peak hold function uses a high-speed mode of the A/D converter allowing it to capture transient weights at a far higher rate than typical scales.

Peak hold is cleared and re-enabled with the , that has been set to *P-HLD*.

Peak hold is not available on NTEP or OIML Legal for Trade certified scales.

### 3.4.6 Units

When the  key is programmed to *UNIT* (Section 4.2 on page 22), pressing the key changes the displayed units.

- Press  to toggle display between available units



**NOTE:** Unit switching is not available on OIML certified Legal-for-Trade scales.

### 3.4.7 High Resolution Test Mode

When the  key is programmed to *HRES* (Section 4.2 on page 22), pressing the key prompts the scale to toggle between normal Weigh mode and High Resolution Test mode. High Resolution Test mode displays weight at x10 resolution. While in High Resolution Test mode, all of the annunciators flash to indicate that the weight display is not set to the approved legal-for-trade resolution.

- Press  to toggle between normal and x10 resolution display

In some cases, the displayed weight in high resolution test mode will require six digits to fully display. In these cases, only the five least significant digits will be displayed. The full weight can be displayed in normal resolution by pressing the function button.

Ex: 1000.02 kg displays as 000.02 kg.



**NOTE:** High resolution test mode is for scale service and diagnostic use only.

*Increasing the scale display resolution beyond the calibrated value does not increase scale accuracy.*

*High resolution test mode is not available in HB-44 and R-76 standards.*

### 3.4.8 Print

When the  key is programmed to *PRINT* (Section 4.2 on page 22), pressing the key prompts the scale to print.

- Press  to print





**NOTE:** The print option must be installed and the print function must be set up in order for the print button to work. See Section 6.2 on page 37 for print setup information.

## 4.0 Setup

The Setup menu enables configuration of the MSI-4260. This section details settings and parameters that are configured in the Setup menu. For navigation and numeric entry information, see [Section 1.5.1 on page 9](#).

### 4.1 Setup Menu

To enter into the MSI-4260 setup menu, press  and  simultaneously.

Parameters	Choices	Description
F <sub>UNC</sub>	OFF	Function User Key 1 – User definable key that can be programmed to one of several functions Function User Key 2 – User definable key that can be programmed to one of several functions; Only available on the RF remote being used with the MSI-4260
	TEST	Test Display – <a href="#">Section 3.4.1 on page 18</a>
	TOTAL	Total – <a href="#">Section 3.4.2 on page 19</a>
	VIEW TOTAL	View Total – Function always available on the RF Remote ( <a href="#">Section 3.4.3 on page 19</a> )
	NET/GROSS	Net/Gross – Function always available on the RF Remote ( <a href="#">Section 3.4.4 on page 19</a> )
	PEAK HOLD	Peak Hold – <a href="#">Section 3.4.5 on page 20</a> ; Function not available or non-functional in OIML R76 or NTEP HB44 modes
	UNITS	Units – <a href="#">Section 3.4.6 on page 20</a> ; Function not available or non-functional in OIML R76 & 1Unit modes
	HIGH RES	High Resolution – x10 display resolution; For testing and maintenance use only; Not a legal Weigh mode; Does not increase scale resolution or accuracy <a href="#">Section 3.4.7 on page 20</a>
	PRINT	Print – <a href="#">Section 3.4.8 on page 20</a>
AUTO OFF	OFF 15 30 45 60	Auto Off Time – Prolongs battery life of scale by turning power off after the set time (in minutes) that the scale is not in use ( <a href="#">Section 4.3 on page 22</a> )
SLEEP	OFF 5 15 30	Sleep – Time (in minutes) before unit will enter the sleep mode ( <a href="#">Section 4.4 on page 23</a> )
DISPLAY	L0-1 L0-2 H1-1 H1-2 AUTO	LED Display Intensity – Used to set the display brightness ( <a href="#">Section 4.5 on page 23</a> )
COLOR	RED	Red
	ORANGE	Orange
	GREEN	Green
	RED-ORANGE	Color changes based on passing setpoints 1 and 2; when selected, if setpoint 2 trips, the display color changes to orange; when setpoint 1 trips, the display color changes to red ( <a href="#">Section 4.6 on page 24</a> )
SETPOINT 1-8	OFF ERR LESS	Setpoint 1 to 8 – Used for warnings or process control ( <a href="#">Section 4.7 on page 24</a> )
TOTAL	OFF TOTAL ON ALOAD ALAST ALIGH	Total Mode – accumulation of multiple weighments ( <a href="#">Section 4.8 on page 25</a> )
WEIGHT FILTER	OFF L0 H1-1	Weight Filter – allows the scale to adjust to situations where there may be movement ( <a href="#">Section 4.9 on page 26</a> )

Table 4-1. Function Key Settings

Parameters	Choices	Description
Unit	Lb •Kg	Weight Units – toggle units between pounds and kilograms; Function not available or non-functional in OIML R76 & 1Unit modes (Section 4.10 on page 27)
Battery Life	Standard Long	Battery Life – sets the options for standard or extended battery life (Section 4.11 on page 27)







Table 4-1. Function Key Settings (Continued)

## 4.2 Set Function Key

The MSI-4260 has one user definable key  on the front panel, that can be programmed to one of several functions. The additional function key is available on the RF remote control being used.

 **NOTE:** If a function key does not work, it is probably because the MSI-4260 is not set up to support the key. For example, if the Function Key is set for TOTAL, the TOTAL mode must also be set up in the Setup menu.

To set the function key use the following steps:







1. Press and hold  and . FUNC displays.
2. Press . The current user key function displays.
3. Press  to scroll through the available functions.
4. Press  when the desired function displays. R-OFF displays.
5. Press . SETOR displays, the unit exits setup and stores the settings.

 **NOTE:** Press  at any time to cancel the procedure.

## 4.3 Auto-Off

The **Auto-Off** feature prolongs the battery life by automatically powering off the unit if no buttons are pressed and there is no change in the load exceeding 10 d for the time period, in minutes, set by the user. When a button is pressed or the detected load is in motion exceeding 10 d, the time limit is reset.

When disabled, the unit will only turn off by pressing , or if the battery dies. To set the **Auto-Off** function:







1. Press and hold  and . FUNC displays.
2. Press  to scroll to R-OFF.
3. Press . The current auto off time displays.
4. Press  to scroll through the available times.
5. Press  when the desired time displays. SLEEP displays.
6. Press  to exit setup and store the settings.

 **NOTE:** Press  at any time to cancel the procedure.

## 4.4 Sleep

The sleep parameter reduces power consumption by automatically turning off the display during periods of inactivity. While in the sleep mode, the green acknowledge annunciator will blink at a one second rate to indicate the unit is in sleep mode. To wake up the unit, either a button must be pushed (front panel or RF remote) or the weight must change by 5 d or more.

 **NOTE:** Sleep must be set to less time than the Auto-Off timer.

1. Press and hold  and . *Func 1* displays.
2. Press the  to scroll to the *SLEEP* function.
3. Press . The current *SLEEP* time displays.
4. Press the  to scroll through the available times.
5. Press  when the desired time displays. *d iSPL* displays.
6. Press  to exit setup and store the settings.





 **NOTE:** Press  at any time to cancel the procedure.

## 4.5 Display Brightness



The *Display* setup menu is used to set the display brightness. There are four fixed brightness settings and one automatic light sensing brightness setting.



Auto setting automatically detects the ambient light and adjusts the brightness of the display accordingly.

There are four fixed brightness settings, *LO-1*, *LO-2*, *HI-1* and *HI-2*. Lower brightness settings increase battery life.

1. Press and hold  and . *Func 1* displays.
2. Press the  to scroll to the *d iSPL*.
3. Press . The current setting displays.
4. Press the  to scroll through the available settings.

 **NOTE:** The display brightness changes when each setting displays.

5. Press  when the desired setting displays. *Color* displays.
6. Press  to exit setup and store the settings.

 **NOTE:** Press  at any time to cancel the procedure.

## 4.6 Display Color

The MSI-4260 display supports four color schemes. Three of the color schemes display a steady color. The fourth, *red-9n*, changes the color of the display when setpoints 1 and 2 are tripped (Section 4.7 on page 24). This is useful in warning of possible overload conditions.

Color	Description
<i>red</i>	Steady red
<i>orange</i>	Steady orange
<i>green</i>	Steady green
<i>red-9n</i>	Variable Color — Display color changes based on setpoints 1 and 2; Green — No setpoints have been tripped Orange — Setpoint 2 tripped, setpoint 1 not tripped Red — Setpoint 1 tripped

Table 4-2. Display Colors

## 4.7 Setpoints

The MSI-4260 supports eight setpoints. Common uses of setpoints are for warnings or process control. It comes standard with LED outputs for a triggered set point.











Figure 4-1. Setpoint LED's



The MSI-4260 has an audible output option that is triggered by Setpoint 1. Contact Rice Lake Weighing Systems for other setpoint output options.

Setpoint	Description
<b>Setpoint Mode</b>	
<i>GREAT</i>	Indicates the setpoint will trigger when the weight exceeds a set value
<i>LESS</i>	Indicates the setpoint will trigger when the weight is less than a set value
<b>Setpoint Weight Type</b>	
<i>NETGR</i>	responds to net or gross weight
<i>GROSS</i>	responds to gross weight regardless of the display
<i>TOTAL</i>	responds to the totaled weight
<i>T-CNT</i>	responds to the total count (number of samples)
<i>LF-CNT</i>	responds to the number of times the weight has exceeded 25% of capacity



Table 4-3. Available Setpoint Settings

To set the setpoint:

1. Press and hold  and . *Func 1* displays.
2. Press  to scroll to the desired setpoint (*SETE 1 - 8*).
3. Press . The current *SETE* mode displays.
4. Press  to scroll to the setpoint mode desired.
5. Press . The current *SETE* weight type displays.
6. Press  to scroll to the desired weight type.
7. Press . The current setpoint weight value displays.

8. Press . The first digit will blink.
9. Press  to scroll to the desired number.
10. Press . The second digit blinks.
11. Repeat [Step 8](#) – [Step 10](#) until the desired value displays.

 **NOTE:** To enter a decimal point, press  while the digit is blinking. To correct a digit, press  to step back.

12. Press . The value will stop blinking and the next setup menu item displays.
13. Repeat [Step 2](#) – [Step 12](#) to set all the setpoints to be used.
14. Press  to exit setup and store the settings.

 **NOTE:** Press  at any time to cancel the procedure.

## 4.8 Total

Total function is used to accumulate multiple weighments so that gross and net readings can be added into the same total number. There are four modes of totalizing: one manual mode and three auto modes.

The manual total mode and three auto total modes all require that the weight on the scale return below 0.5% (relative to full scale) of **GROSS ZERO** or **NET ZERO** before the next weighment can be added. Applied weight must be  $\geq 1\%$  of full scale above **GROSS ZERO** or **NET ZERO** before it can be totaled.

### Manual Total Mode

The manual mode requires the **TOTAL** key be pressed with the weight on the scale. The weight will be added to the previously accumulated value. This assures that a weight on the scale is only added to the total once.

The **USER** key under the **MANUAL TOTAL** mode functions in this manner:



- If weight is greater than 1% of capacity and has not been totaled – Pushing the **USER** key will add the current weight to the TOTAL weight. The displayed weight blinks to indicate the weight was accepted. The TOTAL annunciator lights and the Total weight displays for five seconds and then the number of samples displays for two seconds.
- If current Weight has been totaled – Pushing the **USER** key displays the Total weight for five seconds (View Total) without changing the Total value. The TOTAL annunciator will light during the TOTAL weight display. After five seconds of Total Weight display, the number of samples displays for two seconds.
- If weight is less than 1% of capacity – The **USER** key functions as View Total only and functions as View Total until the 1% threshold is exceeded to allow the next addition to the total value.

### Auto Total Modes

The **USER** key under the **AUTO TOTAL** mode functions as Auto Total On / Auto Total Off.

The Auto mode has three variations which are programmed in the Setup menu:











- **A.LoAd – AutoLoad** ensures any settled load above the Rise above threshold will be automatically totaled. The scale must fall below the Drop below threshold before the next total is allowed.
- **A.LAST – AutoLast** mode takes the last settled weight to auto total with. The total occurs only once the scale goes below the threshold. This allows the load to be adjusted without a total occurring. Once the load is removed, the scale uses the last settled reading for total.
- **A.h i Gh – AutoHigh** uses the highest settled reading. This is useful for loads that can't be removed all at once.

 **NOTE:** Total mode will not function while the scale is in motion, make sure  is on. If the system fails to achieve stable readings, increase the filter setting or increase the size of the scale division (d) in the Init Cal procedure.

**NOTE:** If 1K is illuminated, read the total as the displayed value multiplied by 1000.













## Set Total Mode

1. If the unit is turned off, press and hold  then press .  
If the unit is on, press  and  simultaneously. *Funct* displays.
2. Using the , scroll to *TOTAL*.
3. Press . The currently saved total mode displays.
4. Press  to scroll through the choices.
5. With choice displayed, press  to select. *FILTER* displays.
6. Press  to save and exit to weighing mode or press  to continue to another setup menu item.









## 4.9 Filter Setup

Changing the filter settings allows the scale to adjust to situations where there is a lot a movement in the structure. If the reading is not stable, it can often be improved by increasing the filter setting. Settling time will be longer as the filter setting is increased. However, the MSI-4260 employs algorithms that speed up large weight changes while still controlling vibration even with high filter settings.











Use the following steps to set up filtering.

1. If the unit is turned off, press and hold  then press .  
If the unit is on, press  and  simultaneously. *Funct* displays.
2. Using the , scroll to *FILTER*.
3. Press . The currently saved total mode displays.
4. Press  to scroll through the choices.
5. With choice displayed, press  to select. *Unit* displays.
6. Press  to save and exit to weighing mode or press  to continue to another setup menu item.

## 4.10 Unit

1. Press and hold  and . *FUNC 1* displays.  
If the unit is on, press  and  simultaneously. *FUNC 1* displays.
2. Press  to scroll to *Unit*.
3. Press  to enter *Unit*.
4. Press  to toggle between lb and kg.
5. With the desired choice displayed, press  to select.
6. Press  to save and exit to weighing mode.

## 4.11 Battery Life

1. If the unit is turned off, press and hold  then press .  
If the unit is on, press  and  simultaneously. *FUNC 1* displays.
2. Using the , scroll to *B.L iFE*.
3. Press . The currently saved total mode displays.
4. Press  to toggle between the choices.
5. With choice displayed, press  to select. *FUNC 1* displays.
6. Press  to save and exit to weighing mode or press  to continue to another setup menu item.

## 5.0 Calibration

The MSI-4260 is calibrated using standard weights. The weight used to calibrate, must be at least 15% of full capacity in order to achieve rated accuracy. For example, use at least a 750 kg test weight to calibrate a 5000 kg capacity scale. Although a single span point is usually adequate for rated accuracy, the MSI-4260 supports Multi-Point calibration with up to four span points plus zero.

There are three kinds of calibration:

- **Standard Calibration** – Used for maintenance and routine calibration. ([Section 5.2 on page 29](#))
- **Initial Calibration** – Used to set up both the capacity and resolution (d) of the scale. It differs from Standard Calibration only in the initial steps. The initial calibration is performed after a calibration reset which completely erases the calibration and setup memory. ([Section 5.3 on page 30](#))
- **C-Cal** – Calculated Constant Calibration. Used when test weights are not available. To use C-Cal, a previously generated C-Cal number must be known. ([Section 5.5 on page 32](#))

### 5.1 Calibration Switch Access

Use the following steps to access the calibration switch on the MSI-4260 if calibrating the unit using either the standard calibration or the C-Cal calibration.

1. Remove the hex seal screw from the MSI-4260.

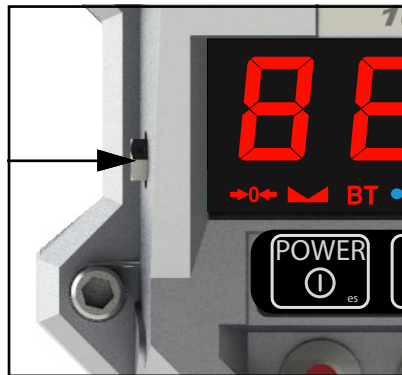





Figure 5-1. Calibration Switch Seal Screw

2. Using a small screwdriver, press the Cal switch located behind the hex seal screw.  $\square RL$  displays.

## 5.2 Standard Calibration

Use the following steps to calibrate the MSI-4260 using the standard calibration procedure.

1. Press Cal switch to initiate Calibration. ([Section 5.1 on page 28](#))
2. Press , `UoLd` displays.
3. Press  when the scale becomes motionless, a blinking `□` displays. If the scale is in range `PASS` displays, then `LoRd 1` displays.

 **NOTE:** If `PASS` does not display, what happens?

4. Load the scale with a test weight.

 **NOTE:** For a single span point calibration, a test weight of more than 15% of capacity or more is recommended

5. Press . The current capacity flashes on the display.

 **NOTE:** If loading the scale with the capacity weight, skip to [Step 8](#).

6. Press  to enter the value of the test weight. The far left digit blinks indicating a number should be entered.

7. Press  to scroll the numbers and  to enter each digit as in [Section 1.5.1 on page 9](#).

8. Press  to save the weight entry. If the cal value is within limits, `PASS` displays briefly then `LoRd 2`.

 **NOTE:** Display displays `LoRd 3` and `LoRd 4` after the second and third cal values have been entered. After the fourth cal value has been entered, `CAL 'd` displays. Continue to .

9. If additional cal points are needed, press  and repeat steps [Step 4](#) through [Step 8](#) for each additional cal point.

10. When all cal points have been recorded, press . `CAL 'd` displays to indicate that the calibration was successful.

11. Press  `C - CAL` briefly displays followed by the C-Cal number.

12. Press  to store the calibration. `SEtUP` displays.







13. Press  to exit the calibration menu. Scale returns to Weigh mode.

14. Replace the hex seal screw that was removed in [Section 5.1 on page 28](#).

### 5.3 Initial Calibration







Use this procedure only if the capacity and count-by (d) needs to be modified. The initial steps of the initial calibration will totally erase user setup as well as any previous calibration.

Use the following steps to calibrate the MSI-4260 using the initial calibration procedure.

1. Turn the MSI-4260 off.
2. Remove the hex seal screw using the steps in [Section 5.1 on page 28](#).
3. Press the **Cal** switch and the **Power** switch on the unit simultaneously. **rESEt** displays.
4. Press  to reset the calibration constants. **SurEP** displays.
5. Press  to confirm. **CAL** displays.
6. Press  to start the configuration. **Unit** displays.
7. Press  to choose unit.
8. Press  to toggle between lb and kg.
9. Press  to confirm unit. **CRP** displays.
10. Press  to set scale capacity. Initial value of **10000** displays.



**NOTE:** 10000 is the initial default value. Capacity should be set no higher than the load cell rated capacity.

11. Press  to change the capacity. the first digit on the display blinks.
12. Press  to scroll the numbers and  to enter each digit as in [Section 1.5.1 on page 9](#).
13. Press  to store the capacity value. **d** displays.
14. Press  to choose scale divisions.
15. Press  to scroll through the recommended scale divisions.
16. Press  to select scale division. **Unit d** displays.
17. Calibrate the MSI-4260 as in [Section 5.2 on page 29](#) beginning with [Step 2](#).

## 5.4 Guidelines for Capacity and Resolution

Capacity and resolution are set in the initial calibration of the MSI-4260.

### 5.4.1 Capacity

Setting capacity is determined primarily by the capability of the load cell.



**NOTE: Never set the capacity of the scale higher than the rating of the load cell.**

It is acceptable to set lower capacities to better match the crane the MSI-4260 is used on. For example, if the hoist is rated for 9000 lb, use an MSI-4260 with 10,000 lb capacity and reset the capacity to 9000 lb so that the scale will indicate overload at 9000 lb instead of 10000 lb. De-rating as much as 50% of the capacity is usually acceptable, but the scale may be less stable if the 'd' is decreased.

Due to kg to lb conversions, the capacity of all MSI-4260 systems is rated approximately 20% higher than the rated capacity in pounds. This is to allow the kg capacity to be exactly 1/2 the number of the pound capacity.

### 5.4.2 Resolution

Due to Legal-for-Trade requirements and general scale design criteria, the weight must be stable for certain features to work:

- ZERO – Weight must be stable to be zeroed
- TARE – Weight must be stable to be tared
- TOTAL – Weight must be stable to be added to the total registers

If the MSI-4260 does not become stable under standard operation, it is recommended that the resolution be reduced and/or filtering increased. Some improvement in stability can be achieved by increasing the filtering ([Section 4.9 on page 26](#)).

Resolution is reduced by increasing the "d" value during initial calibration ([Section 5.3 on page 30](#)). Rice Lake Weighing Systems recommends that the resolution is kept in the 1:2000 to 1:3000 range. Never program the resolution greater than needed.

The third way to increase stability is to increase the **Motion Window**. The MSI-4260 defaults to  $\pm 1d$  as a motion window. It can be changed at Rice Lake Weighing Systems to a higher value if desired. Often  $\pm 3d$  is chosen for bridge cranes as they tend to have a lot of bounce to them. This of course carries an accuracy penalty adding  $\pm 3d$  to the total accuracy of the scale if the zero or tare operation happens to capture the weight in a valley or peak.



**NOTE: Motion Window can only be changed by Rice Lake Weighing Systems.**

## 5.5 C-Cal Calibration











When adequate test weights are not available, the MSI-4260 can be calibrated using a programmed constant calibration number which is referred to as C-Cal. To perform C-Cal, a C-Cal number must be known from a previous calibration. MSI supplies replacement load cells for the MSI-4260 with the C-Cal value stamped on the serial number label. When a calibration is performed with test weights, a new C-Cal is generated. C-Cal can be used when the electronics are replaced to get an approximate calibration that may be suitable for non L-F-T applications.



**IMPORTANT:** The C-Cal number must be known prior to starting this procedure. For a MSI-4260 with its original load cell, MSI prints this number on the calibration record, the serial number tag and on the calibration log found inside the battery compartment.

C-Calibration can be done if the electronics are replaced or a new load cell is installed. C-Cal reduces the absolute accuracy of the system and is intended for non-critical use only. Legal-for-Trade installations require that the MSI-4260 is calibrated using test weights. If a system was originally multi-point calibrated, the C-CAL calibration will erase the additional span points, as C-Cal is only a two point calibration (zero and span at 10% of capacity).

Use the following steps to perform a C-Cal calibration.

1. Remove the hex seal screw from the MSI-4260 and enter the calibration menu using the steps from [Section 5.1 on page 28](#).
2. Press  to scroll to the C-Cal menu selection.  $\bar{C} - \bar{C}AL$  displays.
3. Press  to start the C-Cal procedure.  $\bar{U}nLd$  displays.
4. Remove all weight from hook.
5. Press  to set the zero calibration point. A flashing  $\square$  displays.
6. If the zero is in range,  $PASS$  displays, followed by  $\bar{C}ALP$
7. Press  to confirm.
8. Press  to enter the C-Cal value. The first digit on the display blinks.
9. Press  to scroll the numbers and  to enter each digit as in [Section 1.5.1 on page 9](#).
10. Press  to save the C-Cal value.  $PASS$  displays, followed by  $\bar{C}ALPd$ .
11. Press  to exit C-Cal setup menu and
12. Press  again to store the calibration and return to the scale operation.  $StORe$  displays.

## 5.6 Calibration Setup Menu

Remove the hex seal screw from the MSI-4260 and enter the calibration menu using the steps from [Section 5.1 on page 28](#).

The Calibration Setup menu contains two additional items beyond Calibration:







- Standard menu
- Auto Zero Maintenance menu (AUL00).

In addition, more menus will appear that are transferred from the main setup menu when Legal-for-Trade settings are used.

Selection	Description
Industrial (INDU5)	This is the most common setting for the MSI-4260; With the Industrial standard, you have full range zero, access to units switching, filters, and peak hold
Handbook 44 (HB-44)	Sets the scale to enable only approved features per the NTEP HB-44 rules and regulations; Access is denied to Peak Hold, and the zero range may be limited; The Filter menu is moved to the Cal Setup menu, so filters are only accessible through the Cal Seal
R-76 (R-76)	Sets the scale to enable only approved features per OIML R-76; Only kg weight units are available; The zero range is limited to 4% (-1 to +3% relative to Calibrate zero); Net/Gross function is temporary; Once Net weight is established, pushing an F key set for Net/Gross will cause a maximum 5 second display of the Gross weight; You must clear the Tare to display Gross weight constantly; Other metrological aspects are changed to meet R-76 requirements; Only stable weights may be printed; Negative weight display is limited to -20d
One Unit (UN1)	The one unit Standard is exactly the same as Industrial, except units switching is inhibited; This is useful for Metric only countries; Another use of the One Unit standard is to allow the scale to be calibrated in units other than lb or kg, since conversions are eliminated; Contact MSI for more information on the Standards settings

Table 5-1. Standard Menu Selections

Use the following steps to set up a Legal-for-Trade standard settings.

1. Remove the hex seal screw from the MSI-4260 using the steps from [Section 5.1 on page 28](#) and  $\square RL$  displays.
2. Press .  $SELUF$  displays.
3. Press  to enter the Cal setup menu.
4. Press  to enter the standard menu. The current standard setting displays.
5. Press  to scroll to the desired standard.  $UN1$  displays.
6. Press  to set the standard.  $AUL00 \square RL$  or the next item in the CAL setup menu displays.
7. Press  twice to exit setup and store all changes.  $SE0RE$  displays.









## 5.7 Auto Zero Maintenance

The MSI-4260 employs an auto-zeroing maintenance mechanism to adjust the zero reading to the center-of-zero (COZ). COZ is defined as the weight reading is within 1/4 'd' of zero. AZM continuously adjusts zero to maintain COZ.







It is recommended that AZM is on to maintain the highest accuracy. However, there are circumstances when it should be turned off. This can happen when minor variations of weight occur while picking up scale attachments and the variations fall within the AZM capture window. The AZM capture window (usually 1 'd') and capture time (usually eight seconds) can be adjusted by MSI to meet custom requirements. The settings of AZM are dictated in Legal-for-Trade standards and cannot be adjusted.

Use the following steps to set up the auto zero maintenance.

1. Remove the hex seal screw from the MSI-4260 using the steps from [Section 5.1 on page 28](#) and  $\square RL$  displays.
2. Press .  $SEtUP$  displays.
3. Press  to enter the Cal setup menu.  $SEtAnd$  displays.
4. Press  to scroll to the Auto0 menu.  $Aut0$  displays.
5. Press  to enter the Auto Zero menu. The current setting (blinking) displays.
6. Press  to scroll between the on or off key.
7. Press  to set the auto zero.  $SEtAnd$  displays.
8. Press  twice to exit setup and store all changes.  $SEtOrE$  displays.

## 5.8 Filter

Changing the filter settings allows the scale to adjust to situations where there is a lot a movement in the structure. If the reading is not stable, it can often be improved by increasing the filter setting. Settling time will be longer as the filter setting is increased. However, the MSI-3460C employs algorithms that speed up large weight changes while still controlling vibration even with high filter settings. Selections are  $OFF$ ,  $L0$  and  $H 1 - 1$ .

1. Enter **Configuration** mode ([Section 5.1 on page 28](#)).  $\square RL$  displays.
2. Press  to scroll to  $SEtUP$ .
3. Press .  $SEtAnd$  displays.
4. Press  to scroll to  $F ILtR$ .
5. Press . The current setting displays.
6. Press  to scroll to desired setting.
7. When desired value is displayed, press .  $SEtAnd$  displays.
8. Press  twice to save settings.  $SEtOrE$  displays briefly and exits setup.

## 5.9 Gravity Compensation

Gravity Compensation allows for calibrating in one geographic location for use in a different geographic location. Gravity can be set to OFF, ON, or Factor.

Parameter	Choices	Description	
OFF		Gravity compensation disabled	
ON	--	Calculates Gravity compensation using the origin and destination latitudes and elevations	
	LRtOr	0-90	Latitude of Origin - Original latitude (to nearest degree) for gravity compensation; 47 (default)
	ELtOr	-9999-9999	Elevation of Origin - Original elevation (in meters) for gravity compensation; 10 (default)
	LRtdt	0-90	Latitude of Destination - Destination latitude (to nearest degree) for gravity compensation; 47 (default)
	ELtdt	-9999-9999	Elevation of Destination - Destination elevation (in meters) for gravity compensation; 10 (default)
FACTOr	--	Calculates gravity compensation using origin and destination gravity factors	
	FRcOr	9.00000-9.99999	Gravity of Origin - Original gravity factor (in m/s <sup>2</sup> ) for gravity compensation; 9.8080 (default)
	FRcdt	9.00000-9.99999	Gravity of Destination - Destination gravity factor (in m/s <sup>2</sup> ) for gravity compensation; 9.8080 (default)

Table 5-2. Gravity Compensation Parameters



**NOTE:** To find the local gravity, enter the latitude and elevation into the International Gravity Formula. Listed are links to websites that can be used to determine local latitude and elevation. Please note these website addresses are provided for reference only and may change.











Map Coordinates uses Google maps to find latitude and elevation: [www.mapcoordinates.net/](http://www.mapcoordinates.net/)





Once local latitude and altitude have been determined, use the following link to calculate local gravity <http://www.sensorone.com/local-gravity-calculator/>













**IMPORTANT:** The gravity correction function has not been evaluated by an approvals agency, therefore it is up to the authorized scale dealer to ensure the device is accurate at the intended point of use.

### 5.9.1 Compensation by Latitudes and Elevations

1. Enter **Configuration** mode (Section 5.1 on page 28). `LR` displays.
2. Press  to scroll to `SEtUP`.
3. Press . `SEtAnd` displays.
4. Press  to scroll to `GRcO`.
5. Press . The current setting displays.
6. Press  to scroll to `ON`.
7. Press . `LRtOr` displays.
8. Press  to enter latitude of origin.
9. Press . `ELtOr` displays.
10. Press  to enter elevation of origin.
11. Press . `LRtdt` displays.
12. Press  to enter latitude of destination.

13. Press . *ELEdE* displays.
14. Press  to enter elevation of destination.
15. Press  to accept elevation of destination.
16. Press  twice to save settings. *SEORE* displays briefly and exits setup.

### 5.9.2 Compensation by Gravity Factor

1. Enter **Configuration** mode ([Section 5.1 on page 28](#)). *CRAL* displays.
2. Press  to scroll to *SEtUP*.
3. Press . *SEAnd* displays.
4. Press  to scroll to *CRAL*.
5. Press . The current setting displays.
6. Press  to scroll to *FRcGr*.
7. Press . *FRcGr* displays.
8. Press  to enter original gravity factor.
9. Press . *FRcdE* displays.
10. Press  to enter destination gravity factor.
11. When desired value is displayed, press .
12. Press  twice to save settings. *SEORE* displays briefly and exits setup.

## 6.0 Communications

The MSI-4260 can communicate with peripheral devices using IEEE 802.15.4 Low Rate WPAN, or 802.11 Wi-Fi protocols, 'b', 'g' or 'n'. Only one communication type can exist at a time. Due to difficulties of dangling RS-232 cables from a hanging crane scale, the RF options are more commonly used.

The MSI-4260 has a single communications port allowing access to the embedded ScaleCore through the terminal access mode or Rice Lake software. The terminal access mode is used for updating scale firmware while Rice Lake software can be used for calibration and configuration, backup and adjusting scale settings. This communications port is not intended for output use.

### 6.1 Communications Setup



The 802.15.4 transceiver is used to communicate between the MSI-4260 and other connected ScaleCore devices. The 802.15.4 transceiver is also capable of connecting to any supported device with an 802.15.4 Modem. 802.15.4 operates in the 2.4 GHz ISM band and does not require the end user to obtain a license. 802.15.4 can coexist with other 2.4 GHz systems if caution is taken to isolate antennas at least 10' (3 m) from the crane scales.

The 802.11 Wi-Fi option communicates directly with a standard RF access point. This option is covered by the Wi-Fi for ScaleCore User Guide."

### 6.2 Printer and Serial Output Setup

All RF linked device Weigh modes are available in user formatted form.

Communications port settings are independent of print settings in connected displays/indicators which only in the MSI-4260.

1. Press  and  at the same time to enter the Communication menu. *Pr int* displays.
2. Press  to enter the Print Menu. *L iStn* displays.

Parameters	Choices	Description
<i>L iStn</i>	--	Listen – Connects with an RF remote
<i>out - P</i>	<i>Port.0</i> <i>RF</i>	Output Port – Select output port for print
<i>Strng</i>	--	Serial String – For use in printing ( <a href="#">Section 6.2.1 on page 38</a> )
<i>Ctrl</i>	<i>USER</i> <i>Load</i> <i>Cont inuous</i> <i>OFF</i>	Control – Print mode selected ( <a href="#">Section 6.2.2 on page 38</a> )
<i>Rate</i>	<i>0- 65535</i>	Rate – Output rate in seconds, 0 is the fastest possible setting

Table 6-1. Print Parameters



**NOTE:** The serial output is configured as 9600 baud, Xon/Xoff handshaking, no hardware handshaking, 1 stop bit, no parity. Other baud rates are possible by special order only.

### 6.2.1 Standard Print Strings

Commands that can be used to format gross, net and print formats are shown below. Enter the desired print string number into the String parameter. Combinations of the standard print strings can be entered in the string number entry screen.

*Example: To get a NET, GROSS, TARE printout with a space between records, enter 2349.*

The print string characters in Table 6-2 represent the variable character values in Table 6-3. The ScaleCore Connect software can also be used to create custom output strings. ScaleCore Connect can be downloaded from [www.ricelake.com](http://www.ricelake.com).

Command	Description
<T>	Load data
<U>	Units
<M>	Load mode (lb/kg)
<CRLF>	Carriage return line feed
<SP>	Space
<STX>	Start of text character (ASCII 2)
<P>	Space for positive, - for negative
<W7.>	7-digit weight, floating decimal, leading spaces
<S>	Status, upper case: <SP> =OK, M=Motion, O=Overload, Z=Zero, I=Invalid

Table 6-2. Standard Print Characters

Print String Number	Parameter	Description
1	Current load	Fixed output length: 16; Leading zeros suppressed except for the least significant digit (LSD) <TTTTTT><SP><UU><SP><MMMMM><CRLF>
2	Net load	Fixed output length:16; Leading zeros suppressed except for the LSD <TTTTTT><SP><UU><SP>NET><SP><SP><CRLF>
3	Gross load	Fixed output length: 16; Leading zeros suppressed except for the LSD <TTTTTT><SP><UU><SP>GROSS><CRLF>
4	Tare Weight	Fixed output length: 16; Leading zeros suppressed except for the LSD <TTTTTT><SP><UU><SP>TARE><CRLF>
5	Total Weight	Fixed output length: 16; Leading zeros suppressed except for the LSD <TTTTTT><SP><UU><SP>TTL><CRLF>
6	Number of Samples Totaled	Fixed output length: 16; Leading zeros suppressed except for the LSD <SP><SP><SP><SP><SP><SP><SSSSSS><SP><T-CNT>SP>CRLF>
7	Rice Lake / Condec:	Stream Data Format <STX><P><W7.><U><M><S><CR><LF>
8/9	Carriage Return/Line Feed	Used to add a space between print records <CRLF>

Table 6-3. Standard Print Strings

### 6.2.2 Control Modes

The user can select three print control modes which are described below.



Mode	Description
USER	Printing is controlled by the operator using  if set to <b>Print</b> mode; If using a remote device, there may be a dedicated <b>PRINT</b> key (F-key 3) available
LOAD	One print occurs when a stable load is read. The scale must then return to near zero before another print will occur; <b>Note: Other configurations of loads are available using the ScaleCore Connect software. It can be downloaded from <a href="http://www.ricelake.com">www.ricelake.com</a></b>
CONTINUOUS	The MSI-4260 will continuously output the data at a rate specified in the rate parameter (up to 65,535 seconds); Setting the interval to 0 will set an interval as fast as the system can go
OFF	Printing is disabled. Power consumption is lower with the print off

Table 6-4. Control Modes

### 6.2.3 Printer Output Setup

Use the following steps to set up the printer output.

1. Press  and  at the same time. *Print* displays.
2. Press . *Unit* displays.
3. Press . The current setting flashes.
4. Press . *Unit - P* displays.
5. Press . The current setting flashes.
6. Press  to toggle between *Port0* and *rF*.
7. When the desired setting displays, press . *Setup* displays.
8. Press  to enter.
9. Enter the number using  to scroll through numbers and  to set the string number desired. ([Section 6.2.1 on page 38](#))
10. When set, press  again. *Enter* displays.
11. Press  to enter. Current setting flashes.
12. Press  to scroll through the settings. ([Section 6.2.2 on page 38](#))
13. When desired setting displays, press . *Rate* displays.
14. Press  to enter.
15. Enter the number using  to scroll through numbers and  to set number.
16. Press  again. *Unit* displays.
17. Press  twice to save settings. *Store* displays briefly and exits setup.



**NOTE:** When entering numbers, pressing  will step back a digit for corrections.

### 6.2.4 Custom Print Formatters

The ScaleCore Connect application is used to create custom output formatters. Download the ScaleCore Connect software from the Rice Lake website. For more information see the ScaleCore Connect software manual (PN 185725).

Custom formatters are also configured in the ScaleCore Webserver. For more information, see the ScaleCore Webserver technical manual (PN 208738).

The serial output is configured as 9600 baud, Xon/Xoff handshaking, no hardware handshaking, 1 stop bit, no parity.

Other baud rates are possible by special order only.

## 6.3 RF Network Setup

The MSI-4260 uses 802.15.4 transceivers to communicate with an MSI-8000 or MSI-8004HD Remote Display or another supported device with an 802.15.4 Modem.

 **NOTE: Ensure a relatively clear transmission path exists between the devices to be connected. Radio signals travel primarily by line of sight (LOS), obstructions between stations may degrade the system performance.**



### 6.3.1 802.15.4 RF Network Setup

When equipped with the 802.15.4 option, the MSI-4260 can connect with an MSI-8000 or MSI-8004HD Remote Display or another supported device with an 802.15.4 Modem.













Choices	Parameters/Range	Description
On,OFF	On OFF	Enable RF – Affects continuous mode only
Scale id	0- 254	ScaleCore ID – Used to identify each ScaleCore device in a piconet, must not be duplicated within the same RF Channel
Channel	12- 23	RF Channel – Establishes the base network that all interconnected devices must match, range 12-23
network id	0- 99999	Network ID – A 64 bit number that all interconnected devices must match; The MSI-4260 limits this number to a max of 5 digits in a range of 0-99999 <b>Note: Do not use a small number here to help avoid other 802.15.4 networks that default to a Network ID of 0 Range 0-99999</b>
TYPE	XBEE OTHER	Connection Type – Type of card being used <b>Note: XBEE refers to XBee 802.15.4 RF card; Both XBEE 2SC, XBee 3 and XBee 3-Pro use the XBEE parameter</b>
Hold	On OFF	Set to On if there is one or more radio modules installed; This is required if the Rugged Remote or a remote display will be used to turn the MSI-4260 on; This causes some battery to drain when the scale is off; Hold should be set to off unless this is require in order to maximize battery life













Table 6-5. RF Menu Parameters

To configure RF Network:

1. Press the  and  keys at the same time. *Pr int* displays.

 **NOTE: *buzz* may flash momentarily before entering the communications menu.**

2. Press . *RF* displays.
3. Press . *On,OFF* displays.
4. Press  to enter parameter. The current value flashes.
5. Press  until *On* displays.
6. Press . *Scale id* displays.
7. Press . The current ID flashes. If SCID is correct, continue to [Step 9](#).
8. Enter the ID using  to scroll through numbers and  to set number.
9. When ID is set, press  again. *Channel* displays.
10. Press . The current channel flashes. If the channel number is correct continue to 12.
11. Enter the channel using  to scroll through numbers and  to set number.

12. When channel is set, press  again.  $nEt$  id displays.
13. Press . The current net ID flashes. If the net ID is correct, continue to 15.
14. Enter the network ID using  to scroll through numbers and  to set number.
15. When the Net ID is set, press  again.  $TYPE$  displays.
16. Press  to enter parameter. The current value flashes.
17. Press  until  $0bEE$  displays.
18. Press .  $Hold$  displays.
19. Press  to enter parameter. The current value flashes.
20. Press  until desired setting displays.
21. Press .  $0nOFF$  displays.
22. Press  twice to save and exit to **Weigh** mode.



**NOTE:** When entering numbers, pressing  will step back a digit for corrections.













### 6.3.2 Hold Feature

The hold feature is used to keep the modem on even when the display is off. It is used if desired with a rugged remote or a remote display.



**NOTE:** The hold feature causes the device's modem to remain on when the device is turned off. This continuously draws from the battery, decreasing battery life.

To Enable it follow these steps:

1. Press  and  simultaneously. `Prnt` displays.
2. Press . `rF` displays.
3. Press . `OnOFF` displays.
4. Press  to enter `OnOFF`.
5. Press  to select `On`.
6. Press  to scroll to `Hold`.
7. Press  to enter the `Hold`.
8. Press  to select `On`.
9. Press  twice to store settings and return to Weigh mode.

## 6.4 Radio Compliance

All radio options meet FCC and international radio compliance per the certification information listed in this section.

These modules may have additional international certifications that are not listed in this section.

Please contact Rice Lake Weighing Systems if you require operation in a jurisdiction that is not listed.

### 6.4.1 802.15.4 (XBee 3 and XBee 3-PRO)

#### FCC Statement

Contains FCC ID: MCQ-XBEE3

#### International Certifications

**Canada:** Radio Certificate Number: IC 1846A-XBEE3

**Australia:** RCM

**Brazil:** ANATEL 06329-18-01209

**EU (XBee 3 only):** Yes, when used with CE approved products

**Japan (XBee 3 only):** R210-119309

**Mexico:** IFETEL (IFT) RCPDIXB19-1820

**South Korea (XBee 3 only):** R-C DIG-XBEE3

## 6.4.2 802.15.4 (XBee 2SC)

### FCC Statement

Contains FCC ID: MCQ-S2CTH

### International Certifications

**Canada:** Radio Certificate Number: IC 1846A-S2CTH

**Australia:** RCM

**Brazil:** ANATEL 0616-15-1209

**EU:** Yes, when used with CE approved products

**Japan:** R210-105563

**Mexico:** IFETEL (IFT) RCPDIS219-1821-A1

**South Korea:** MSIP-CRM-DIG-XBee-S2C-TH

## 6.4.3 Wi-Fi

### FCC Statement

Contains FCC ID: T9J-RN171

### International Certifications

**Canada:** Radio Certificate Number: IC 6514A-RN171

**Korea:** Radio Certificate Number: KCC-CRI-029-RN-171

**Europe:** The product is compliant with the following standards and/or other normative documents:

- EN 300 328 : V1.8.1 (2012)

This product is compliant with the following standards and/or other normative documents:

Safety (article 3.1A) EN 60950-1:2006+A11:2009+A1:2010+A12:2011

EMC (article 3.1b) EN 301 489-1 : V1.9.2 (2011) In accordance with the specific requirements of ETSI EN 301 489-17: V2.2.1 (2012)

## 6.4.4 Bluetooth

### FCC Statement

Contains FCC ID: T9J-R41-1

### International Certifications

**Canada:** Radio Certificate Number: IC 6514A-RN411

**Europe:** This product is compliant with the following standards and/or other normative documents:

- EN 300 328-1
- EN 300 328-2 2.4GHz

## 6.4.5 FHSS (Frequency Hopper Spread Spectrum)

### FCC Statement

Contains FCC ID: HSW-DNT24

### International Certifications

**Canada:** Radio Certificate Number: IC 4492A-DNT24

ETSI Certified

## 7.0 Optional Rugged Remote

The MSI-4260 with an installed RF modem can be controlled with an optional Rugged Remote. The Rugged Remote is a transmit only device that can be used to perform basic scale functions. The range may vary up to 100' or more depending on room conditions and line of sight.

The RF modem in the MSI-4260 must be configured to accept communication from the Rugged Remote, contact Rice Lake Weighing Systems for pairing requirements.



**NOTE:** A Rugged Remote is paired to an individual device and cannot be reprogrammed in the field.



Figure 7-1. Rugged Remote

### 7.1 Operation

The Rugged Remote is paired to a single ScaleCore RF device and replicates the front panel buttons. Slight variations between each device's buttons will result in different operation in the Rugged Remote. See Table 7-1 for corresponding buttons for the Rugged Remote and the connected device.



**NOTE:** The Rugged Remote can only be paired to a single ScaleCore device. Reprogramming to configure communication to a different ScaleCore device can only be performed at the factory or with the purchase of additional RF modems.

Rugged Remote	MSI-4260	Description
		Power
		Zero
		Tare
		Function

Table 7-1. Corresponding Buttons

### 7.1.1 Power

The Rugged Remote can be enabled to turn on and off the ScaleCore device it is paired remotely. The hold function must be enabled in the MSI-4260 ([Section 6.3.2 on page 42](#)).



**NOTE:** The Hold feature causes the device's modem to stay on and continuously draw from the battery, even when the device is turned off, resulting in decreased battery life.

### 7.1.2 Zero



Press  to remove small deviations in zero when the MSI-4260 is unloaded ([Section 3.2 on page 17](#)).

This key is not programmable.

### 7.1.3 Tare

Press  to tare the MSI-4260 is unloaded ([Section 3.3 on page 17](#)).

### 7.1.4 Programmable Function Keys

 and  are programmable in the MSI-4260. Function is defaulted to Test in the MSI-4260. See [Section 4.2 on page 22](#) to configure the MSI-4260 function key for Rugged Remote operation.

## 7.2 Conflict and Jamming Considerations

It is important to understand that only one transmitter at a time can be activated within a reception area. While the transmitted signal consists of encoded digital data, only one carrier of any frequency can occupy airspace without conflict at any given time. This is not to say that there cannot be multiple remote controls for the unit, but rather that two cannot be used simultaneously.

## 7.3 FCC Compliance

The Rugged Remote has 802.15.4 certification ([Section 6.4 on page 42](#)).

## 8.0 Troubleshooting/Maintenance

Problem	Possible Cause	Solution
The display is blank when the <b>POWER</b> button is depressed	Discharged battery	Recharge the battery; Allow at least four hours charge
	Defective battery	Replace the battery
	Corroded battery or battery contacts	Clean the battery contacts
	Defective switch or circuit board	Requires authorized service
The display does not function properly, the front panel button does not function normally or the scale will not turn off	Improperly updated software	Reinstall the software
	Faulty circuit board	Requires authorized service
	Loose connectors	Requires authorized service
The scale does not respond to weight changes	Out of calibration	Calibrate the unit
	Faulty load cell	Replace the load cell
	Load cell connector	Check the connector and wires
The display over ranges below 100% capacity	Tared weight is added to load to determine overload point	Return to gross Weigh mode
	Zero requires adjustment	Rezero the scale
	Too much weight has been zeroed	Rezero the scale
The display drifts	AZM (Auto0) is turned off	Turn AZM on
	Rapid temperature changes such as moving the scale from indoors to outdoors	Wait until the scale temperature has stabilized
	Bad load cell	Check load cell and load cell wiring
The displayed weight shows a large error	Scale not zeroed before load is lifted	Zero the scale with no load attached
	lb/kg units causing confusion	Select the proper units
	Requires recalibration	Recalibrate the unit
	Damaged load cell	Check load cell and load cell wiring
The display reading is not stable	Excessive vibration in crane system	Increase filtering or increase 'd' in Cal
	Excessive side loading	Improve load train symmetry
	Load cell faulty	Check the load cell connections
The display toggles between "Error" and "Load"	Weight exceeds capacity	Reduce weight immediately
	Calibration Faulty	Recalibrate
	Faulty load cell or wiring	Check load cell and load cell wiring
The display toggles between "Error" and "UnLd"	Weight in below the zero range	If the scale is in compression, remove the source
	Calibration faulty	Recalibrate
	Faulty load cell or wiring	Check the load cell connections
The display toggles between "Error" and "A2DLo"	A/D is saturated negative	Check the load cell and load cell wiring
Display toggles between "Error" and "buttn"	A key is stuck or is being held down	Check switches for damage
		Ensure that a remote is not transmitting continuously
Rugged Remote does not work	Units are not paired	See <a href="#">Section 6.3 on page 40</a>
Some Rugged Remote keys do not work but the ACK light blinks	The keys were not enabled during the setup process	Enable the keys by running the transmitter and receiver address procedures
Lo Batt is blinking	The battery is low	Recharge the battery
Unit turns on, then immediately turns off	The battery is low	Recharge the battery
Weight will not zero	The system not stable	The stable annunciator must turn on for Zero to function; Increase the filtering for more stability Increase the filtering for more stability
	Zero is out of range	Legal-for-Trade units have limited zero range; Reduce the weight or use Tare instead
The weight will not Zero, Tare or Total	The system is not stable	Wait for Stable annunciator to turn on, or if in a mechanically noisy crane, increase the filtering or increase the size of the scale increment "d". It is also possible to increase the motion window; Contact MSI if you have a problem getting the MSI-4260 to zero, tare, or total due to stability issues
Setpoint lights blink	Setpoint enabled and trigger point reached	Disable set points if they are not needed
Manual total does not work	A Function key is not set to "Total"	Set up Func1 or Func2 for "Total"
	The weight must be stable	Increase filtering for more stability
Auto Total does not work	The weight must be stable	Wait for the stable annunciator to turn on, or Increase filtering for more stability
	Weight thresholds not reached	Must exceed 1% of capacity for autototal to work; Must drop below 0.5% of capacity for additional weighments to register

Table 8-1. Troubleshooting

## 8.1 Service Counters



**IMPORTANT:** Only a Rice Lake Weighing Systems factory representative can reset the service counters, as these are an important safety warning feature. A thorough load train inspection is necessary to ensure product safety.

Service Counters are important safety warning features and can only be reset at the factory by certified Rice Lake personnel.



As part of the reset process, the service technician will perform a thorough load train inspection to ensure user safety and confirm that the product is ready to be returned for regular service.

See the *Crane Scale Safety and Periodic Maintenance Manual (PN 153105)* for proper loading techniques to improve the safety and longevity of your MSI Overhead Weighing Product. Download the *Crane Scale Safety and Periodic Maintenance Manual (PN 153105)* at [www.ricelake.com](http://www.ricelake.com).

The MSI-4260 maintains two service counters for safety.

- The first one counts the number of times the scale has been overloaded
- The second counter counts lifts above 25% of capacity

These counters serve to warn the user to inspect the load train after a number of overloads, also when there is a chance of fatigue failure. The power up routine will be interrupted when the lift counter exceeds 16383 lifts or the overload counter exceeds 1023 overloads. If the screen displays  $LF\overline{L}nt$  when unit is powered on:



1. Press  to display the 25% lift counter.
2. Press  again to see the overload lift counter.
3. Press  to acknowledge the warning and return to standard scale operation.



**NOTE:** The power up warning message will not appear again for another 16383 lifts (or 1023 overloads).





### Access the Service Counters

Use the following steps to access the service counters.

1. Program a user function key to be  $F\overline{E}5F$  (Section 4.2 on page 22).
2. Press .
3. Press . The display flashes
  - $LF\overline{L}nt$  (for Lift Counter) followed by the number of times the weight has exceeded 25% of capacity
  - $OL\overline{L}nt$  (for Overload Counter) followed by the number of times the weight has exceeded capacity
  - $C - \overline{C}RL$  followed by the C-Cal value

Then the display returns to the **Weigh** mode.

To stop the scrolling and step through them slowly proceed to [Step 4](#).

4. Press  immediately after  is pressed.
5. Press  to scroll through counters.
6. Press  to enter the counter, the value displays.
7. Press  to return to Weigh mode.



**NOTE:** After service counters are viewed a few times, the automatic warning stops, but counters continue to monitor lifts.

## 8.2 MSI-4260C Dimensions

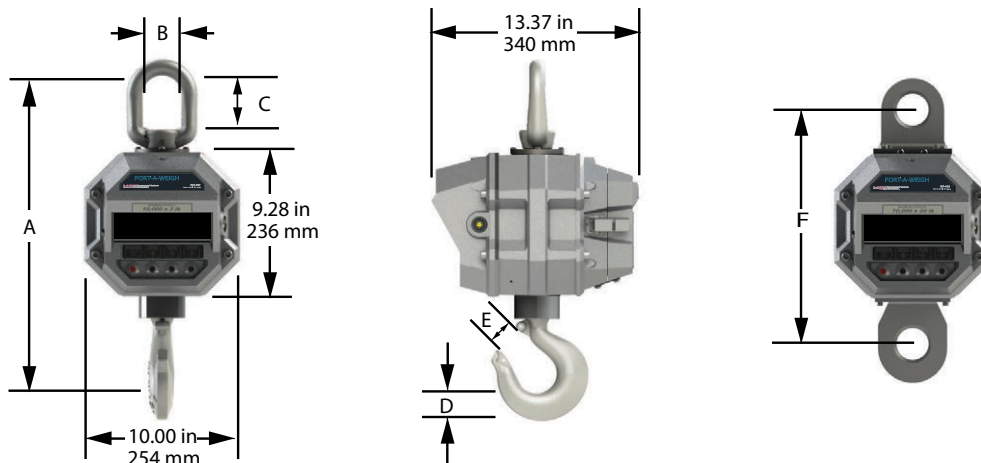

Figure 8-1. MSI-4260 Dimensions

Capacity	A	B	C	D	E	F
500 lb (250 kg)	18.3 in (465 mm)	2.25 in (57.1 mm)	3.06 in (77.7 mm)	1.44 in (37.0 mm)	1.41 in (36.0 mm)	--
2,000 lb (1,000 kg)	18.3 in (465 mm)	2.25 in (57.1 mm)	3.06 in (77.7 mm)	1.44 in (37.0 mm)	1.41 in (36.0 mm)	--
5,000 lb (2,500 kg)	20.5 in (521 mm)	2.50 in (64.0 mm)	3.50 in (89.0 mm)	1.81 in (46.0 mm)	1.69 in (42.9 mm)	--
10,000 lb (5,000 kg)	20.5 in (521 mm)	2.50 in (64.0 mm)	3.50 in (89.0 mm)	1.81 in (46.0 mm)	1.69 in (42.9 mm)	--
20,000 lb (10,000 kg)	28.5 in (724 mm)	4.00 in (101.6 mm)	6.25 in (159 mm)	2.62 in (66.5 mm)	2.41 in (61.2 mm)	--
30,000 lb (15,000 kg)	30.0 in (762 mm)	4.00 in (101.6 mm)	6.25 in (159 mm)	3.00 in (76.2 mm)	3.19 in (81.0 mm)	--
50,000 lb (25,000 kg)	41.0 in (1041 mm)	5.00 in (127 mm)	6.00 in (152 mm)	3.62 in (92.0 mm)	3.63 in (92.0 mm)	15.0 in (381 mm)
70,000 lb (35,000 kg)	43.2 in (1097 mm)	5.00 in (127 mm)	6.00 in (152 mm)	4.56 in (116 mm)	3.75 in (95.3 mm)	15.0 in (381 mm)
100,000 lb (50,000 kg)	52.1 in (1324 mm)	5.75 in (146 mm)	6.65 in (169 mm)	5.06 in (129 mm)	4.25 in (108 mm)	15.0 in (381 mm)

Table 8-2. MSI-4260 Dimensions

Capacity	Resolution	Approximate Shipping Weight
500 lb (250 kg)	0.2 lb (0.1 kg)	53 lb (24 kg)
2,000 lb (1,000 kg)	1 lb (0.5 kg)	53 lb (24 kg)
5,000 lb (2,500 kg)	1 lb (0.5 kg)	62 lb (28 kg)
10,000 lb (5,000 kg)	2 lb (1 kg)	62 lb (28 kg)
20,000 lb (10,000 kg)	5 lb (2 kg)	105 lb (47 kg)
30,000 lb (15,000 kg)	10 lb (5 kg)	125 lb (55 kg)
50,000 lb (25,000 kg)	10 lb (5 kg)	235 lb (106 kg)
70,000 lb (35,000 kg)	20 lb (10 kg)	270 lb (121 kg)
100,000 lb (50,000 kg)	20 lb (10 kg)	420 lb (189 kg)

Table 8-3. MSI-4260 Specifications

## 9.0 Specifications

### Accuracy

± 0.1% +1 d of applied load

### Resolution

2,000 to 5,000 d standard (up to 10,000 d available)

### Enclosure

NEMA Type 4, IP66 marine grade 356 alloy anodized cast aluminum

### Lifting Eye, Shackle and Hook

Crosby® or equal with 360° thrust-bearing swivel hook

### Design Overload

200% Safe / 500% Ultimate (except where noted)

### Functions

Power: Turns unit ON or OFF

Zero: Zeros applied load up to 100% of capacity (limited range in NTEP configuration)

Tare: Tares applied load and displays weight in Net mode

F1: Programmable as TEST, UNITS, NET/GROSS, TOTAL & PEAK HOLD

### Display

Five-digit, 1.2 in (30mm) LED display, multi-color (red, orange, and green)

### Displayable Units

Pounds or kilograms selectable

### Annunciators

COZ, Net, Gross, Total, Peak, Low Battery, lb/kg, Motion, Setpoints

### Power

12 volt rechargeable battery (115/230 VAC battery charger is included)

### Operating Time

Up to 200 hours between charging with typical use, less with RF modem

### Temperature Range:

Operating: -40°F to 122°F (-40°C to 50°C)

Certified: 14°F to 104°F (-10°C to 40°C)

### Auto-Off Mode

Select for 15, 30, 45 minutes, 1 hour or Off

### Auto Sleep Mode

Power down during non-use and power up with weight change or any key press

### Service Counters

Counts number of lifts over percentage of capacity and lifts over capacity

### Calibration

Digital

### Filtering

OFF, LO, HI-1, HI-2 selectable

### Radio Link

802.15.4 at 2.4 GHz

### Warranty

One-year limited

### Approvals



NTEP

CC 19-122: 500 lb to 70,000 lb



Measurement Canada

AM-6198: 500 to 5,000 lb

AM-6249: 10,000 to 20,000 lb







© Rice Lake Weighing Systems Content subject to change without notice.

230 W. Coleman St. • Rice Lake, WI 54868 • USA USA: 800-472-6703 • International: +1-715-234-9171