

DFW SERIES

USER MANUAL - v5

ENGLISH

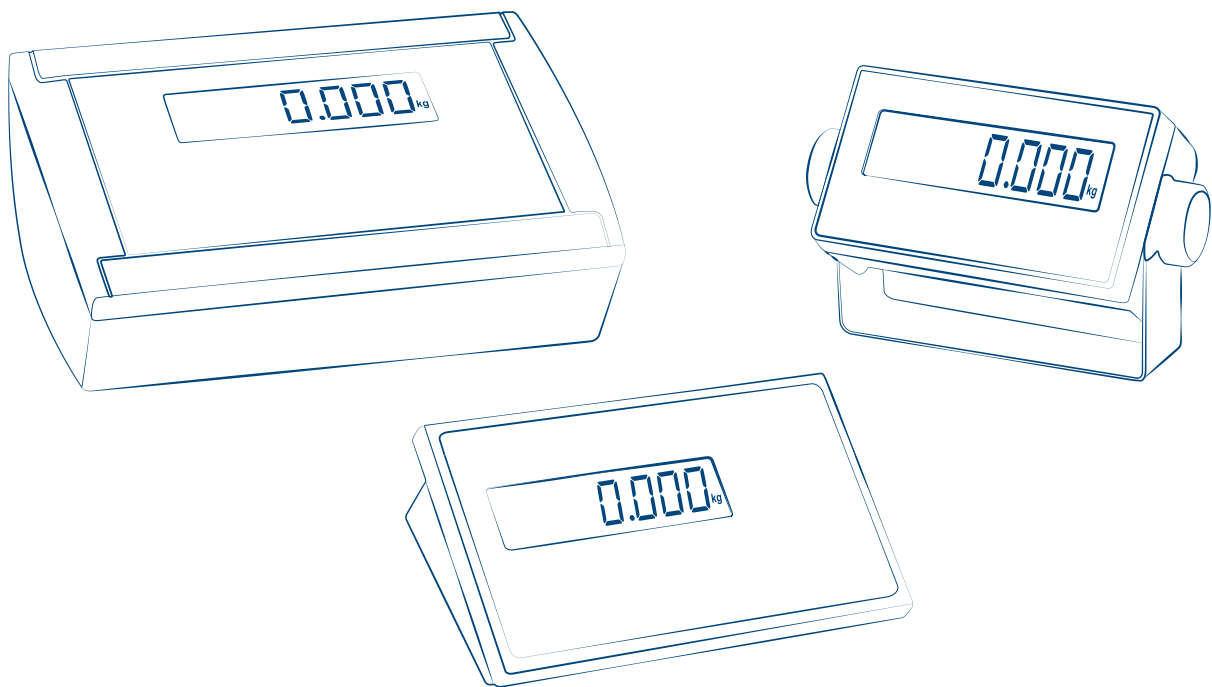

INTRODUCTION	5
WARNINGS	5
MAIN FEATURES	6
POWER SUPPLY VIA MAINS	7
POWER SUPPLY VIA BATTERY	7
INTEGRATED THERMAL PRINTER	7
CUSTOMISABLE PRINTOUTS	8
AUTOMATIC RESET WHEN SCALE IS SWITCHED ON	8
SAVING BATTERY POWER	9
AUTOMATIC SWITCHING OFF	9
AVAILABLE TARE FUNCTIONS	9
REMOTE CONTROL	10
THE DISPLAY	11
IDENTIFICATION OF THE METROLOGICAL SOFTWARE	12
BASIC FUNCTIONS	13
ON	14
OFF	14
ZERO	14
AUTOMATIC TARE	15
TARE DELETION	15
PRESETTABLE TARE (PT)	16
PRINTOUT (AND REPRINT OF THE LAST TICKET)	17
METRICS	17
REGULATION OF THE DISPLAY BRIGHTNESS	18
ADDITIONAL FUNCTIONS	19
SETTINGS A TARE VALUE ALREADY KNOWN (PT)	20
20 TARES ARCHIVE	20
AUTOMATIC TARE DELETION	21
NUMERICAL IDS	22
DATE AND TIME	23

ADVANCED FUNCTIONS	24
HOW TO ACCESS THE FUNCTION MENU AND SELECT THE DESIRED ONE	25
WEIGHING WITH HIGH RESOLUTION DISPLAY - <i>h i . r E5</i>	26
HORIZONTAL ACCUMULATOR - <i>t o t A L</i>	28
MIXING SEVERAL COMPONENTS - <i>F o r M u L</i>	30
COUNTING - <i>C o u n t</i>	32
WEIGHT CHECK - <i>C h E C K</i>	35
UNIT OF MEASUREMENT CONVERSION - <i>C o n V E r</i>	38
PERCENTAGE WEIGHING - <i>P E r C</i>	39
HOLDING WEIGHT ON THE DISPLAY - <i>h o l d</i>	42
EXCHANGE BETWEEN NET WEIGHT AND GROSS WEIGHT - <i>n e t G r o</i>	43
CONFIGURATION MENU	44
<i>C L o C K</i> - DATE AND TIME	45
<i>P r E C . 1 0</i> - HIGH RESOLUTION READING DIVISION	45
<i>A L i b i</i> - ALIBI MEMORY READING	46
<i>S E t P o r t</i> - RELAY PORTS	46
<i>F i l t E r</i> - WEIGHING FILTERS	47
<i>S C r E E n</i> - ADJUSTING THE DISPLAY	48
<i>t A r E</i> - TARE	49
<i>A u t o F F</i> - AUTOMATIC SWITCHING OFF	49
<i>o n . P r i n</i> - MANUAL PRINTER SWITCHING ON	49
<i>t i k e t</i> - TICKET NUMBER RESET	50
<i>r E S E t</i> - FACTORY CONFIGURATION RESET	50
<i>d i A G</i> - DIAGNOSTICS	50
FAQ	51
PRINT	52
ACCUMULATION	52
TARE	52
WEIGHING	53
PIECE COUNTER	53
ERROR MESSAGES	54

INTRODUCTION

The purpose of this manual is to familiarise the user with the different weight indicator operating modes, key functions and display instructions.

We recommend carefully following the instructions when programming the weight indicator, as to do otherwise could jeopardise proper scale operation.

In addition to having all the conventional features of a high precision scale, the indicator offers extra user features such as the function of converting the unit of measurement into pounds, converting net weight/gross weight, gross weight or net weight setpoint, in-out truck weighing, single scale universal repeater, multi-scale repeater, approved weight transmission to PC with alibi memory, +/- checkweighing, sample weight percentage, weight hold on display, peak sensor, weighing accumulator, piece counting. These features make it suitable both for industrial use as well as for legal use with third parties and in trade, meeting the most up to date needs as far as transmission and data printing via the two bidirectional serial ports.

This manual was written with the utmost care but we always welcome feedback on any inaccuracies you may find.

WARNINGS

The instrument is covered by warranty and **MUST NOT BE OPENED BY THE USER** for any reason. Any attempt to repair or modify the unit could expose the user to the risk of electrical shock and will render all warranty conditions null.

All problems with the unit or the system must be communicated to the manufacturer or the dealer from which it was purchased. In any case, **DISCONNECT POWER** before any operations.

The instrument is insulated between the dangerous voltage area and the parts that are accessible to the user.

- Do not pour liquids onto the indicator (except for models with IP65 protection or higher).
- Do not use solvents to clean the indicator.
- Do not expose the instrument to direct sunlight or sources of heat.
- Set or secure the indicator and the platform on a base with no vibrations.
- All the indicator connections must be made respecting the applicable standards in the installation area and environment.

Whatever is not explicitly described in this manual is to be considered improper use of the equipment.

Do not install in atmospheres with the risk of explosion.



The crossed out wheeled bin symbol on the product shows that it must be brought to appropriate separate waste collection centres at the end of its life cycle or returned to the dealer when purchasing a new equivalent product. Proper separate collection to then send the product to recycling contributes to preventing possible negative effects on the environment and to health and promotes recycling. Users who dispose of the product illegally shall face administrative sanctions as provided for by law.

MAIN FEATURES

of the scale

Power supply via mains	7
Power supply via battery	7
Integrated thermal printer	7
Customisable printouts.....	8
Automatic reset when scale is switched on.....	8
Keyboard lock.....	8
Saving battery power.....	9
Automatic switching off	9
Available tare functions	9
Remote control	10
The display	11
Identification of the metrological software	12

POWER SUPPLY VIA MAINS

Every DFW range indicator is equipped with a specific power cable or charger, depending on the model. The only exceptions are the specific models for explosive atmospheres, in which case refer to the specific manual. The safety standards in force must be respected when connecting the unit to the 110/240V mains, including the use of a “clean” line with no disturbances or interferences caused by other electronic equipment. The power-on LED (if available) on the front panel comes on if the instrument is powered correctly. If there is an internal rechargeable battery, it is charged automatically.

POWER SUPPLY VIA BATTERY

Internal battery charge level indicator

 Charged battery

 Low battery

The `Low.bAtt` message precedes automatic instrument switching off.

Battery charging indicator



INTEGRATED THERMAL PRINTER

The printer is usually in STAND-BY and is only powered by the weight indicator when it is time to print in order to ensure the battery holds it charge longer.

Once printing is complete, the printer automatically goes back into STAND-BY.

How to manually switch on the printer

Go into the configuration menu and enable the `on.Pr in` function (see page 49)

How to replace the roll

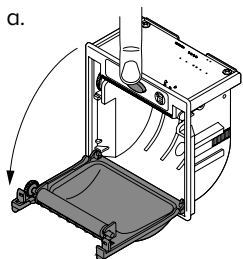

Open the door by pressing the centre button.

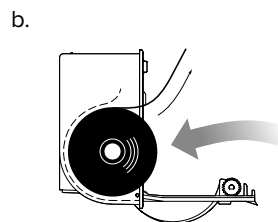

Put the roll in, keeping the thermal surface facing outward.

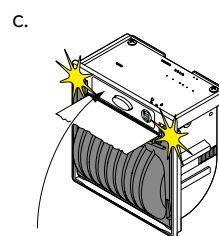

Close the door by pressing on both sides.

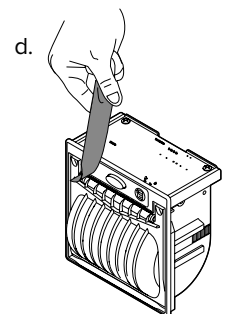

Remove the excess paper.

CUSTOMISABLE PRINTOUTS

If the instrument is equipped with a printer, the ticket or label can be customised as shown in the following example.

⚙️ *Customising printouts requires advanced configuration.*

Example of ticket/label

MARIO ROSSI SRL VIA DELL'INDUSTRIA, 20 41042 - FIORANO (MO) - ITALY WWW.MARIOROSSI.IT		Heading
WEIGH N. 1		Progressive weighing number (for accumulation modes)
GROSS 15.000 kg TARE 3.000 kg NET 12.000 kg		Weight data
TICKET N. 54321		Progressive ticket number
05/08/2015 15:39:03		Date and time
		Bar code 39

Esempio di packing list

MARIO ROSSI SRL VIA DELL'INDUSTRIA, 20 41042 - FIORANO (MO) - ITALY WWW.MARIOROSSI.IT	
WEIGH N. 0001 NET 1.000 kg	
WEIGH N. 0002 NET 1.000 kg	
WEIGH N. 0003 NET 1.000 kg	
WEIGH N. 0004 NET 1.000 kg	
TOTAL WEIGHS 0004 TOTAL NET 4.000 kg TICKET NR. 12345 09/05/06 15:39:03	

AUTOMATIC RESET WHEN SCALE IS SWITCHED ON

If a weight less than 10% of the capacity is on the scale when it is switched on, the weight is automatically reset. This function is useful in automatically resetting a container, pallet or small structure without having to recalibrate the scale.

i Weights over 10% can be reset by changing the original calibration. Automatic reset when the scale is switched on can be deactivated.

⚙️ *Automatic reset when the scale is switched on requires advanced configuration.*

KEYBOARD LOCK

The indicator keyboard can be deactivated in order to avoid accidentally carrying out the available functions.

⚙️ *Keyboard lock requires advanced configuration.*

SAVING BATTERY POWER

The instrument is equipped with advanced battery power saving functions designed to increase operating time.

 *Saving battery power requires advanced configuration.*

AUTOMATIC SWITCHING OFF

This function activates when the scale is completely unloaded and has not been used for a set amount of time (*standard 5 minutes*). To activate or deactivate automatic switching off, go into the autoff section in the configuration menu (*see page 49*).

WARNING

In accumulation and formulation mode, automatic switching off causes the accumulation in progress to be lost.

AVAILABLE TARE FUNCTIONS

The instrument allows you to choose from specific tare functions for your needs:

- “Locked” tare (standard factory configuration).
- “Unlocked” tare: automatically deleted every time the scale is unloaded. Useful in preventing errors when the tare is different for every weighing.
- Tare acquired automatically by the scale. Tare is only acquired if there is no other saved tare value.
- Tare function disabled.

To customise the tare function, go into the *tARE* section in the configuration menu (*see page 49*).

REMOTE CONTROL

The instrument can be equipped with an infrared or radio frequency remote control.

Remote control functions

KEYBOARD	FUNCTION		
	TARE MODE	MULTI-FUNCTION	
		SHORT	LONG
ZERO	TARE	Zero	-
TARE	TARE	Tare	Manual tare (PT)
MODE	TARE	Operating mode	-
PRINT	TARE	Print	-
C	TARE	Cancel/Delete	Stand-by/Switch-on
NUMERICAL KEYS	TARE	-	-
F1	TARE	-	-
F2	TARE	-	-
F3	TARE	-	-

 *The remote control requires advanced configuration.*

Additional radio frequency remote control configurations

Multi-remote control

Useful when several operators are using the same scale (up to 3).

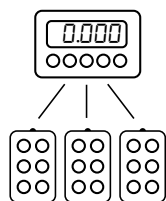

Broadcast

Useful when you need to command several scales with the same remote control.

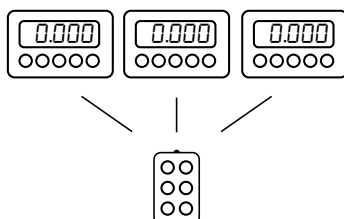

Ad hoc

Useful when there are several scales installed in the same area, each managed by its own remote control.

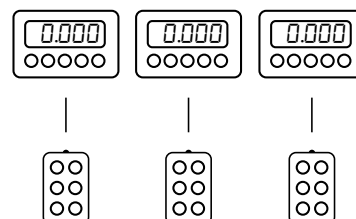

THE DISPLAY



Number	Symbol	Description
(1)	→0←	The scale is unloaded and at zero (gross).
(2)	~	The weight is unstable.
(3)		The time is being shown on the display.
(4)	NET	The weight displayed is net. There is a saved tare.
(5,6)	G B	The weight displayed is gross.
(7)		Battery level.
(8)	Max= Min= e=	Metrics are being displayed.
(9)	LT	A locked tare is active.
(10)	PT	A manual tare is active.
(11)	W1 W2 W3	Indicate the range of active weighing.
(12)	lb ... Pcs	Units of measurement - Pounds (lb), tonnes (t), kilograms (kg), grams (g), number of pieces (Pcs).
(13)		The weight is being displayed in high resolution.
(14)	*	Indicates a key is pressed. In some operating modes, it indicates that a specific function is active.
(15)	SP1... SP4	Indicate the active relay ports (only with the optional board).

LETTERS:

A	B	C	D	E	F	G	H	I	J	K	L	M	N	O	P	Q	R	S	T	U	V	W	X	Y	Z
a	b	c	d	e	f	g	h	i	j	k	l	m	n	o	p	q	r	s	t	u	v	w	x	y	z

NUMBERS:

0	1	2	3	4	5	6	7	8	9
0	1	2	3	4	5	6	7	8	9

IDENTIFICATION OF THE METROLOGICAL SOFTWARE

1. Turn off the scale

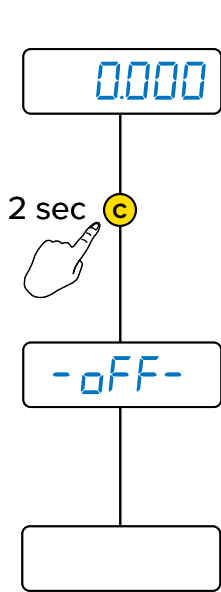

2. Follow the procedure:

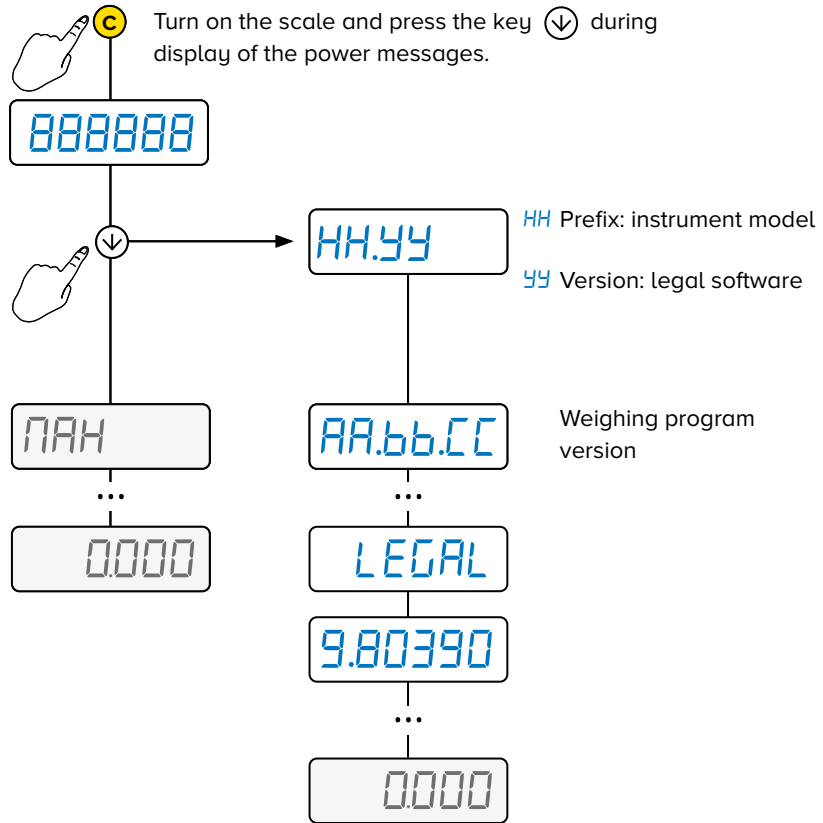

BASIC FUNCTIONS

of the scale

On.....	14
Off.....	14
Zero.....	14
Automatic tare	15
Tare deletion	15
Presettable tare (PT).....	16
Print.....	17
Metrics.....	17
Regulation of the display brightness.....	18

ON

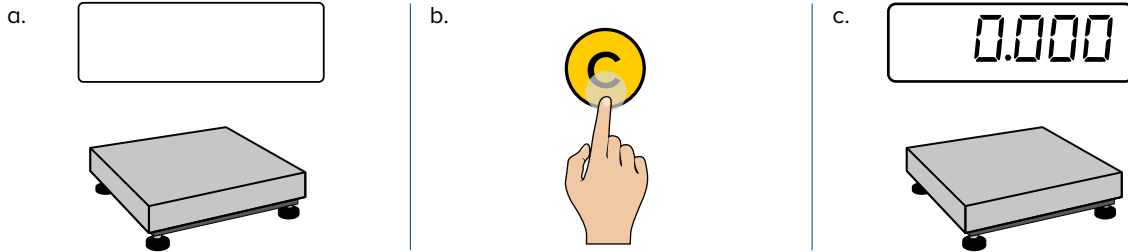

OFF

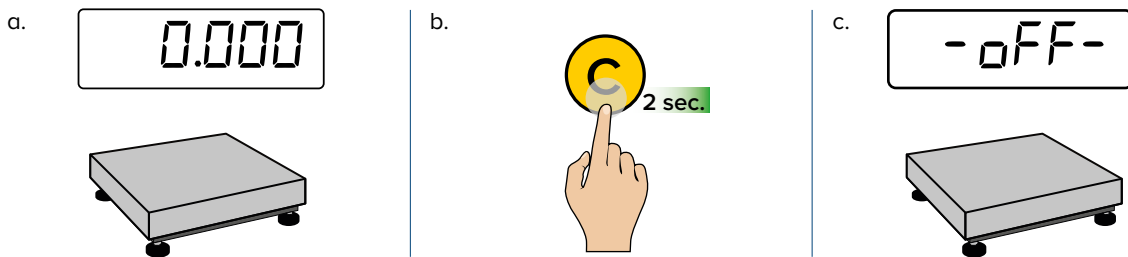

ZERO

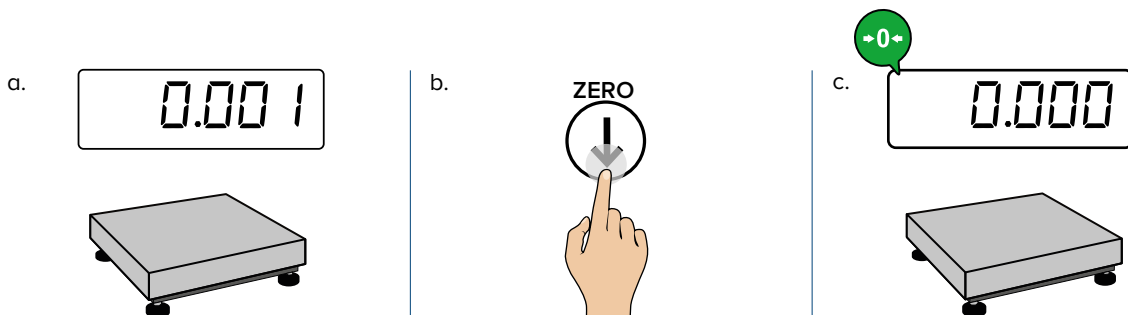

AUTOMATIC TARE

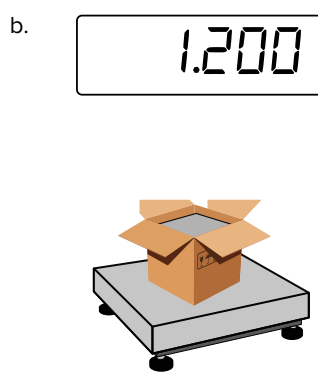
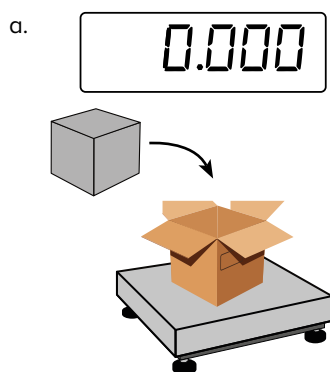
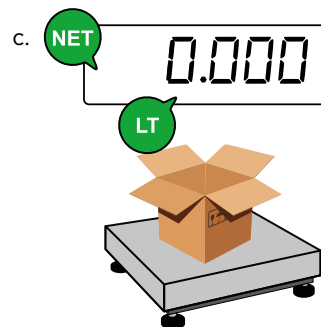
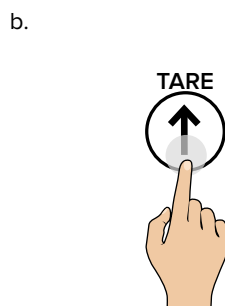
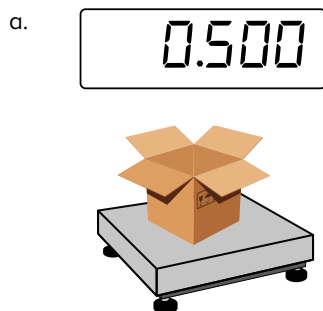

TARE DELETION

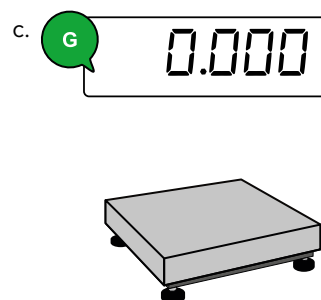
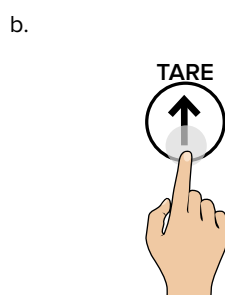
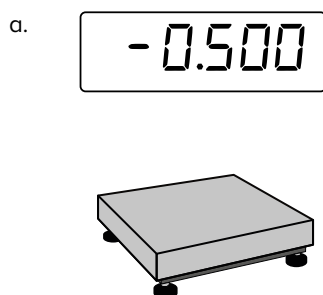

PRESETTABLE TARE (PT)

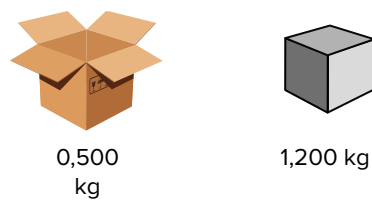
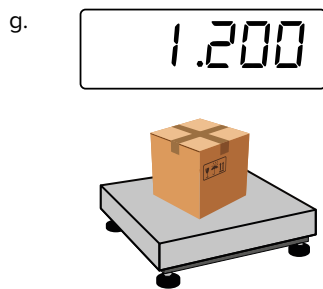
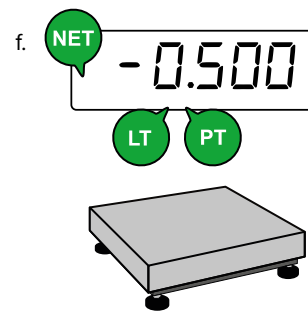
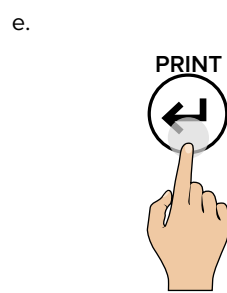
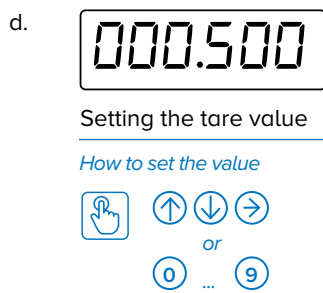
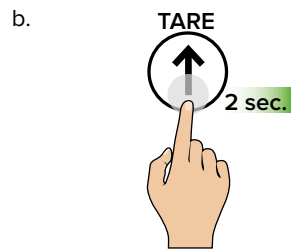
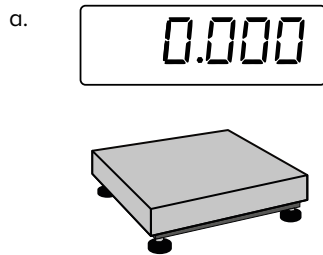

i

If the pallet truck has a number keypad, it is possible to enter the tare quickly:

a. Enter the tare value

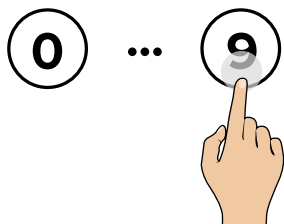

b.



PRINTOUT (AND REPRINT OF THE LAST TICKET)

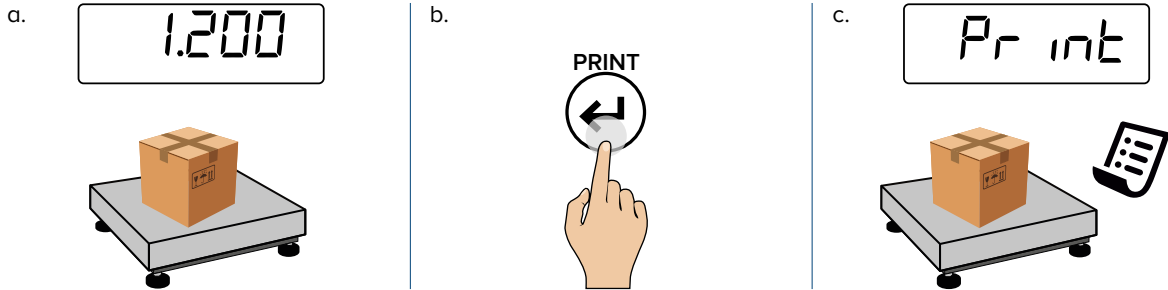

To reprint the last ticket (for models with numerical keyboard)

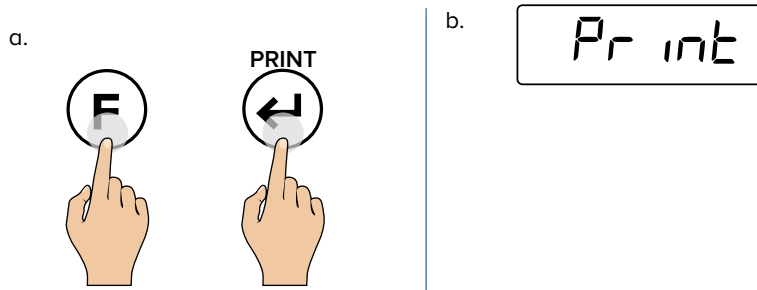

METRICS

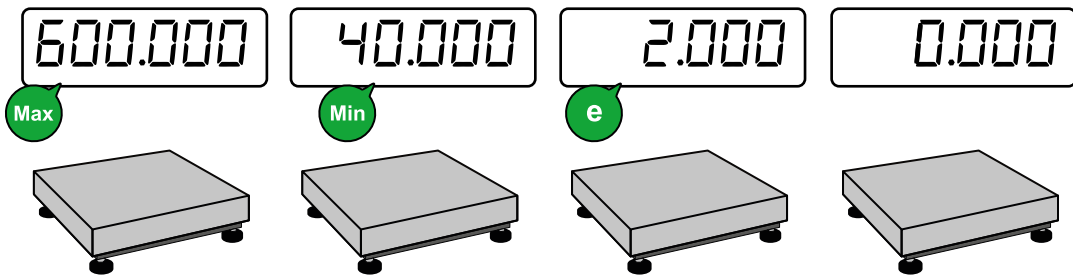
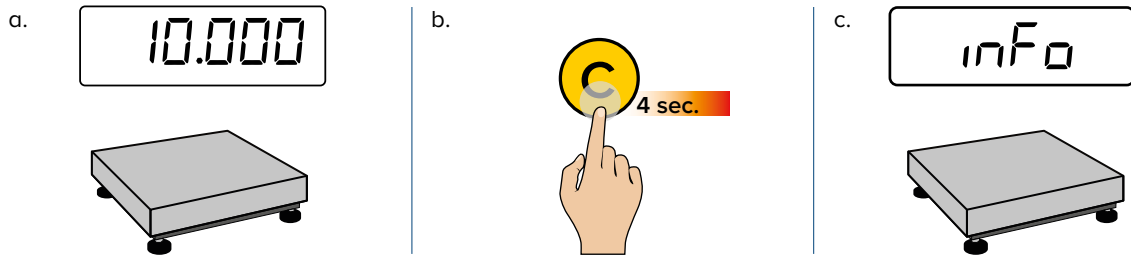

REGULATION OF THE DISPLAY BRIGHTNESS

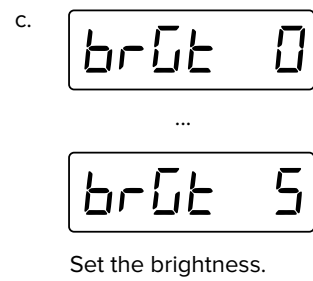
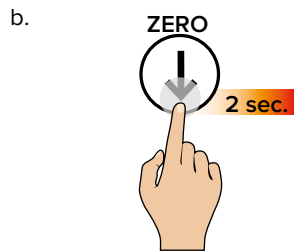
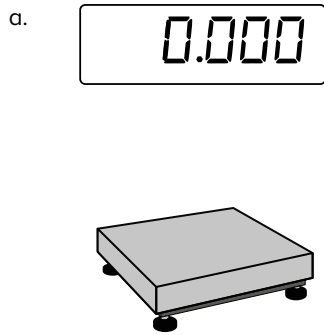

How to set the value



ADDITIONAL FUNCTIONS

for models with numerical keyboard

Setting a tare value already known (PT).....	20
20 tares archive	20
Automatic tare deletion.....	21
Numerical IDs.....	22
Date and time.....	23

SETTINGS A TARE VALUE ALREADY KNOWN (PT)

a. Enter the tare value

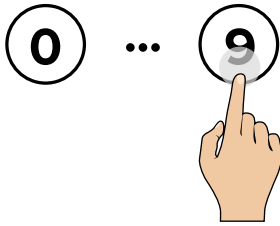

b.



20 TARES ARCHIVE

This memorises the most commonly used tares (up to 20), to simplify retrieval with quick selection.

Example

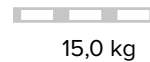
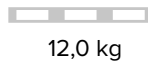
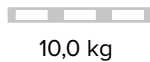

How to store a tare

a.

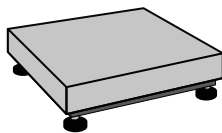
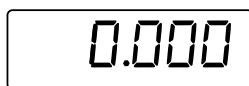

b.

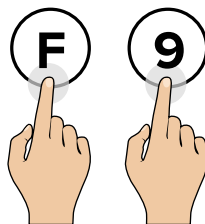

c.



Select the memory.

How to set the value



d.



e.



Enter the tare value

How to set the value



f.



g.

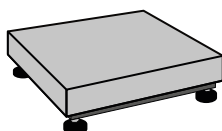

How to retrieve a stored tare

a.

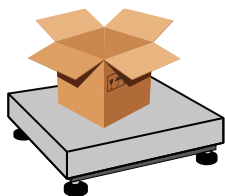

b.

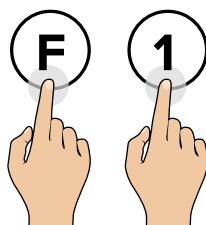

c.

Select the memory.

How to set the value

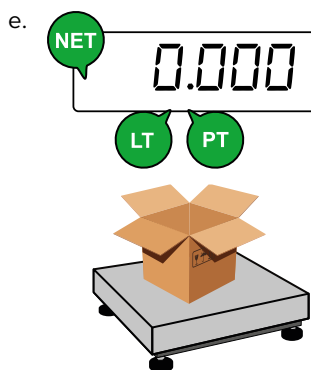
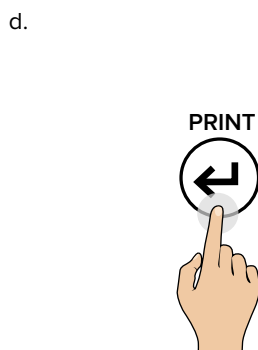

AUTOMATIC TARE DELETION

a.

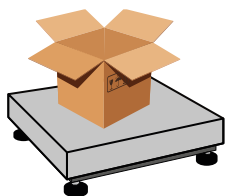

b.

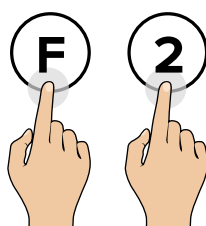

c.

Automatic deletion disabled

Automatic deletion enabled: the tare will be deleted automatically when the pallet truck is completely unloaded.

NUMERICAL IDS

The instrument is fitted with 2 memories for the temporary registration of numerical codes that can be used to identify the product, the operator, the lot etc... These codes, if entered, will be present in the ticket when printing.

How to enter the ID

a.

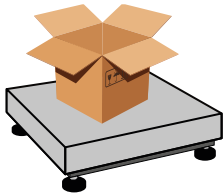
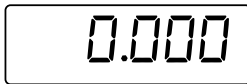

b.

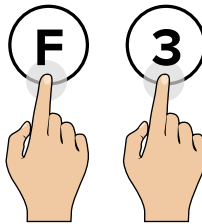
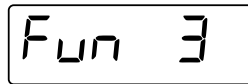

c.

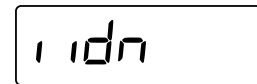

Select the memory.

How to set the value



d.

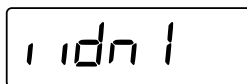

e.



Enter the required ID
(up to 10 digits)

How to set the value



f.



How to enable automatic ID deletion

a.

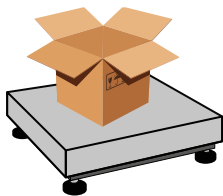

b.

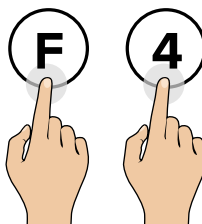
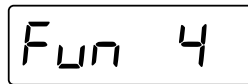

c.

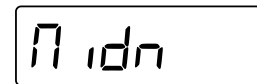

Select the memory.

How to set the value



d.

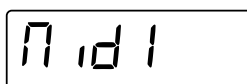

e.

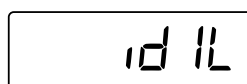

Automatic deletion disabled.

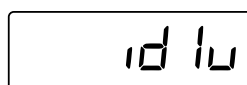

Automatic deletion enabled: the entered ID will be deleted automatically when the pallet truck is completely unloaded.



The numerical IDs zero automatically when turning off the scale.

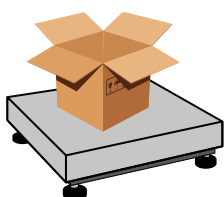

DATE AND TIME

a. 

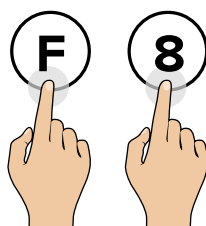

b. 



c.  



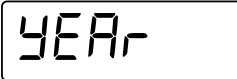





i

Only if the option date and hour is present.

ADVANCED FUNCTIONS

of the scale

How to access the function menu and select the desired one	25
High resolution weighing (H i . r E5)	26
Accumulation (t o t A L)	28
Mixing several components (F o r M i x)	30
Piece counting (C o u n t)	32
Weight check (C h E C K)	35
Unit of measurement conversion (C o n V E r)	38
Percentage weighing (P E r C)	39
Holding weight on the display (h o l d)	42
Net/gross weight display (n E t . G r o)	43

HOW TO ACCESS THE FUNCTION MENU AND SELECT THE DESIRED ONE

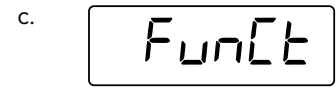
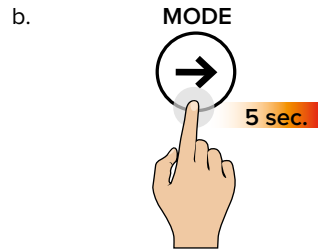
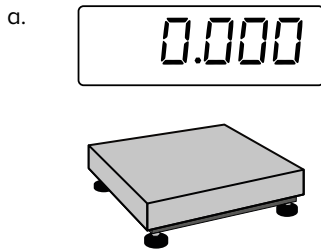

The indicator is in the function menu: the currently active function appears.

d. Select the function

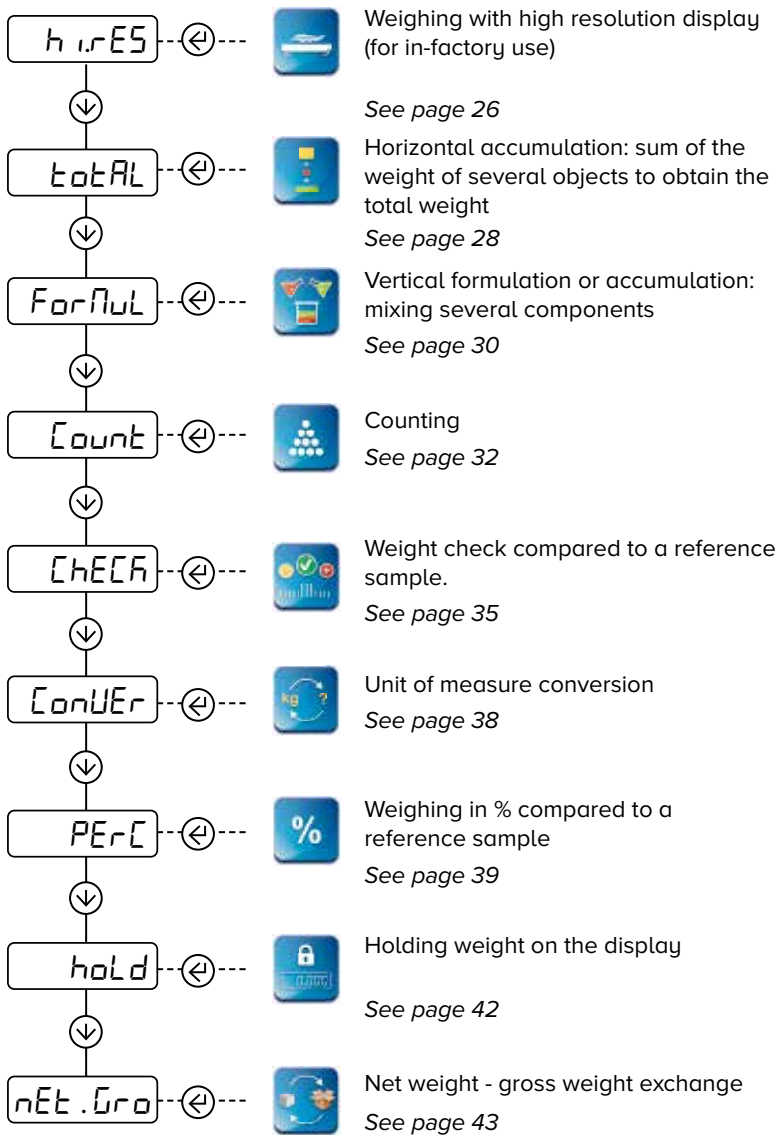

Once you have selected the function, the scale goes back to weighing mode.

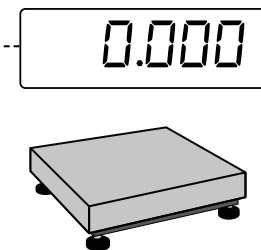



WEIGHING WITH HIGH RESOLUTION DISPLAY - h.r.E5

How to check calibration, if necessary

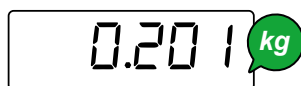
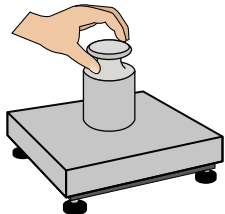

How to adjust calibration, if necessary

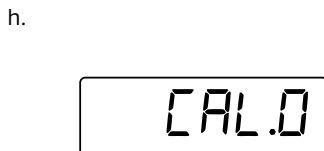
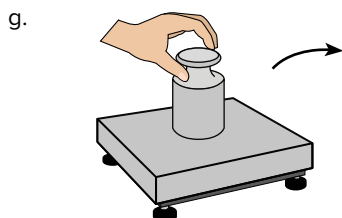
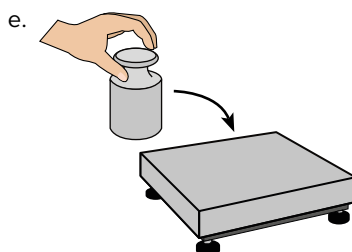
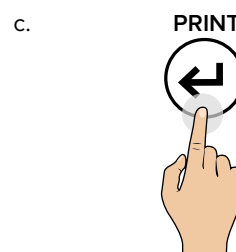
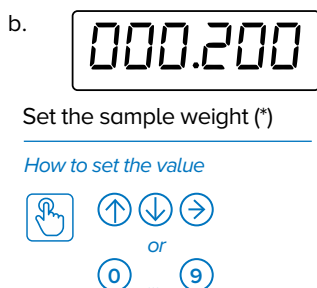
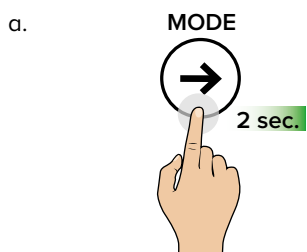

(*) The weight used may not differ by more than 2 % from the weight by which the balance was calibrated.
Check finished calibration

WEIGHING WITH HIGH RESOLUTION DISPLAY - h.r.E5



How to select the desired reading division

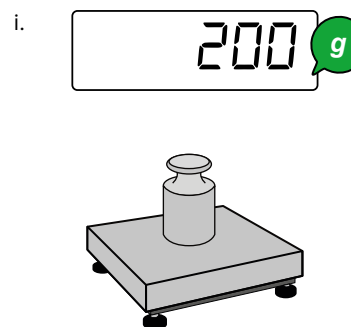
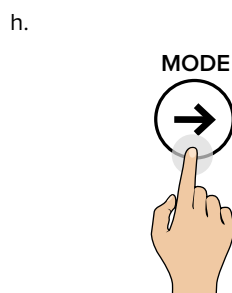
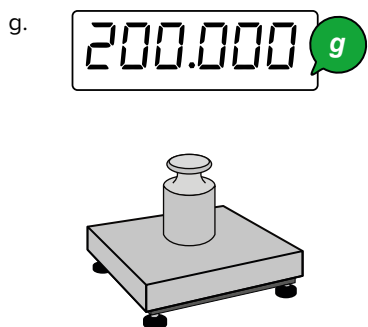
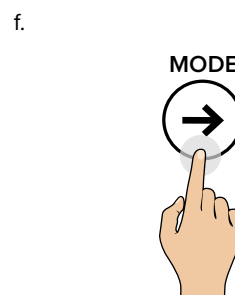
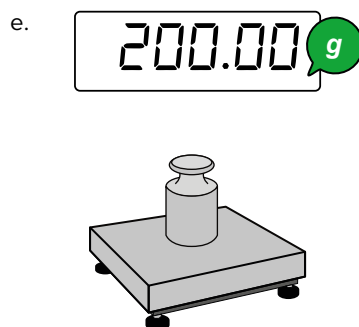
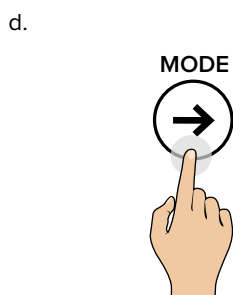
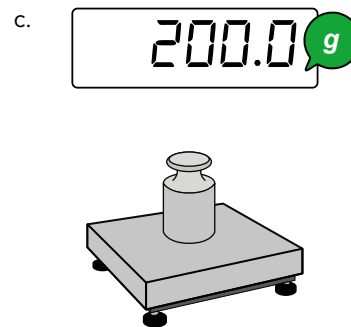
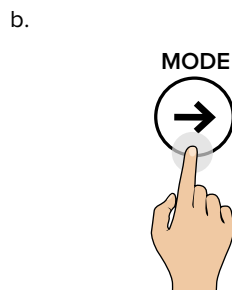
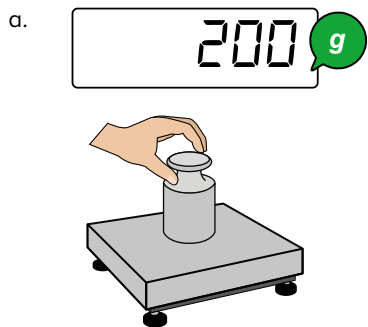

*This operating mode requires configuring an appropriate filter (h.r.E50...h.r.E57) (see page 25).
the maximum number of decimal digit is 3.*



HORIZONTAL ACCUMULATOR - total

How to sum the weighs

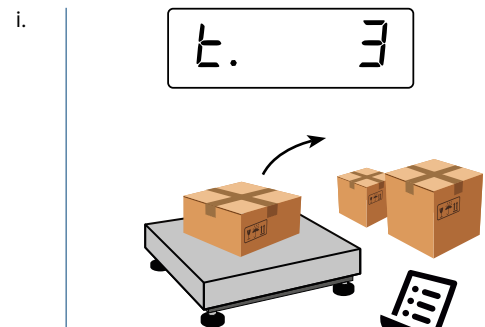
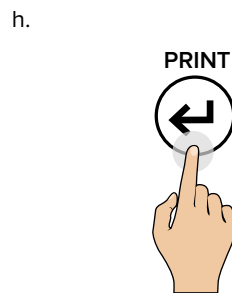
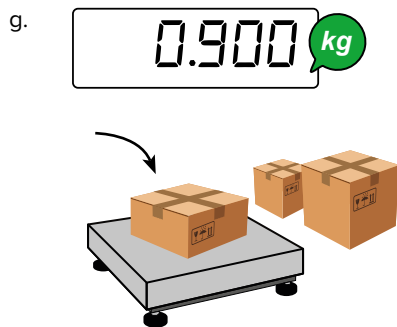
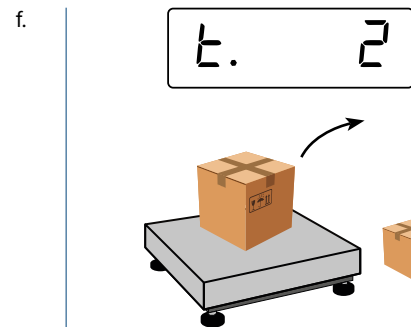
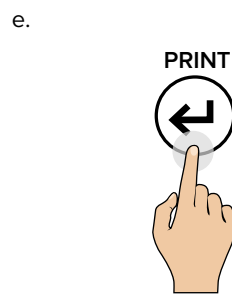
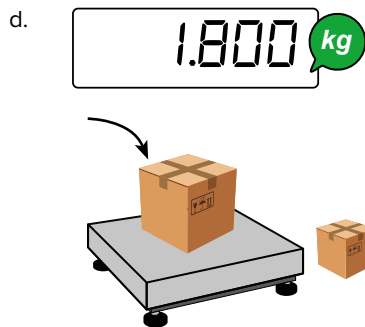
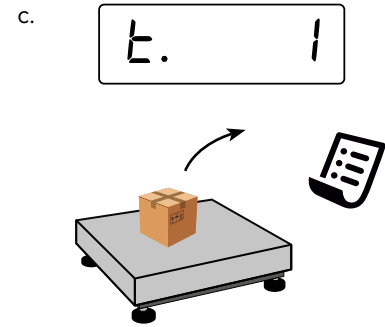
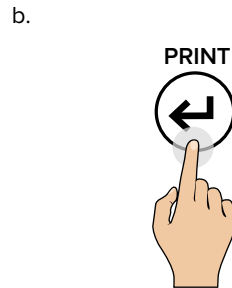
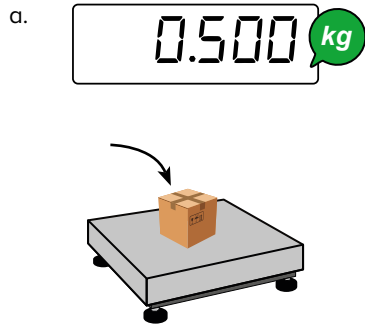

HORIZONTAL ACCUMULATOR - *total*



How to momentarily read the total

a.



b.

n. 3

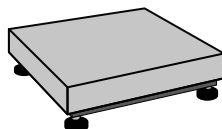

Number of weights

3.200 kg

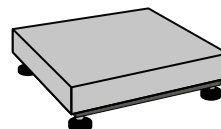

Total weight



i

With numerical keyboard, **(F) + (7)** simply shows the current total without any printout/reset.

How to end accumulation and reset the total

a.



b.

n. 3

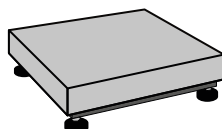

Number of weights

3.200 kg

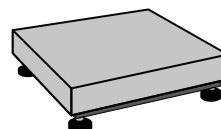

Total weight



i

With numerical keyboard, **(F) + (7)** simply shows the current total without any printout/reset.

How to print and reset the grand total

a.

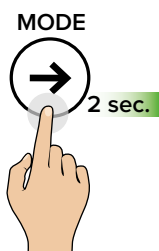

b.

n. 3

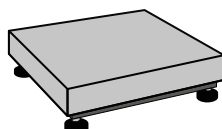

Number of weights

3.200 kg

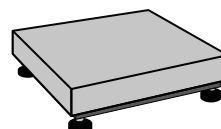

Total weight



i

With numerical keyboard, **(F) + (6)** simply shows the current total without any printout/reset.



MIXING SEVERAL COMPONENTS - Formula

How to sum the weighs

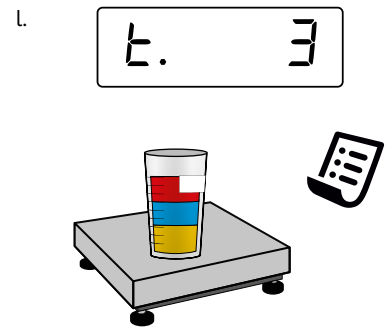
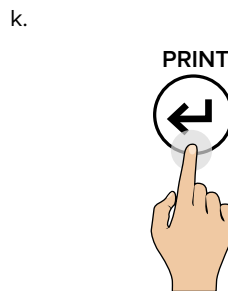
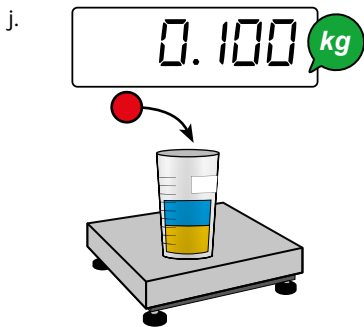
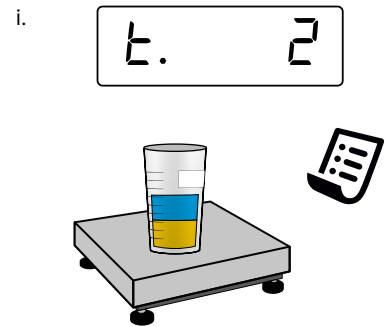
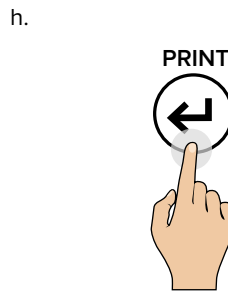
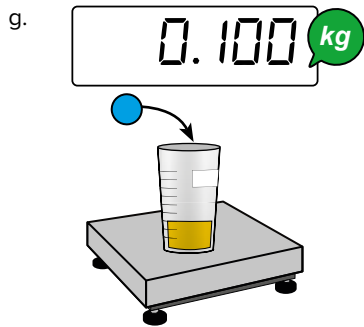
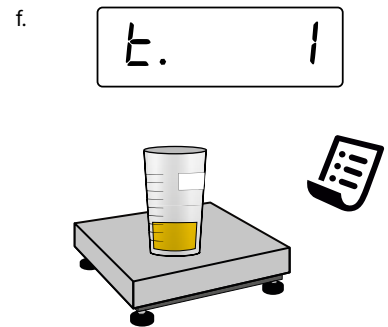
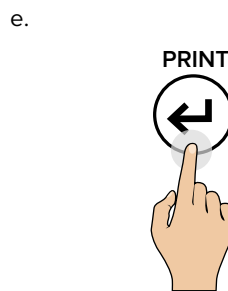
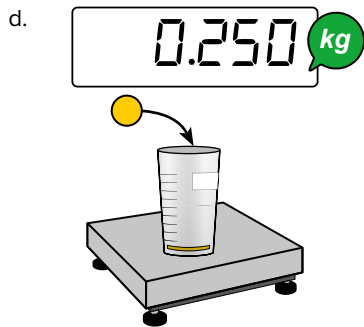
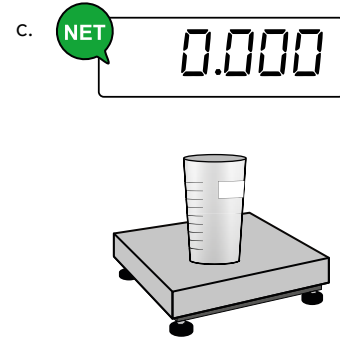
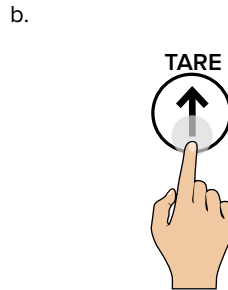
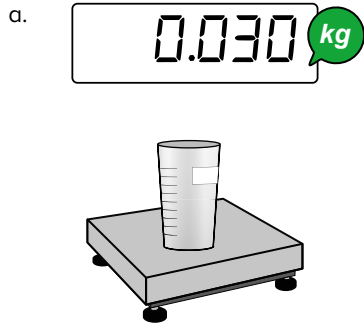

MIXING SEVERAL COMPONENTS - ForNul



How to momentarily read the total

a.



b.

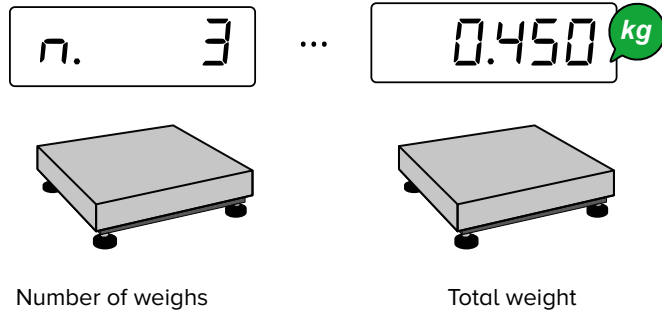

i

With numerical keyboard, **(F) + (7)** simply shows the current total without any printout/reset.

How to reset the total

a.



b.

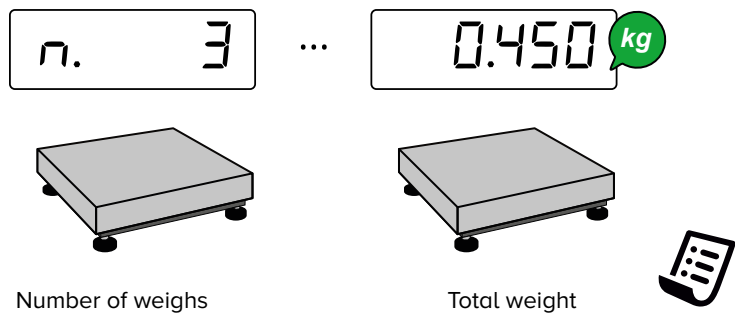

i

With numerical keyboard, **(F) + (7)** simply shows the current total without any printout/reset.

How to print and reset the grand total

a.



b.

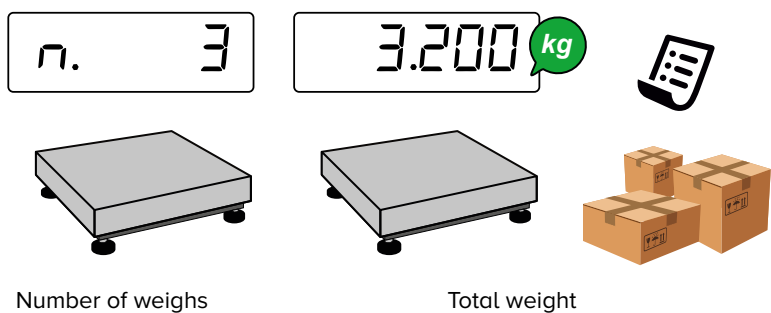

i

With numerical keyboard, **(F) + (6)** simply shows the current total without any printout/reset.



COUNTING - Count

How to sample and count

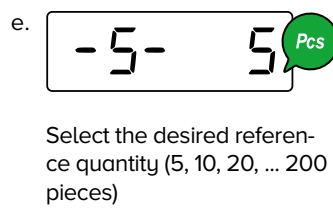
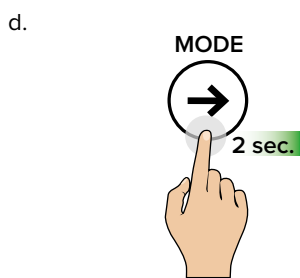
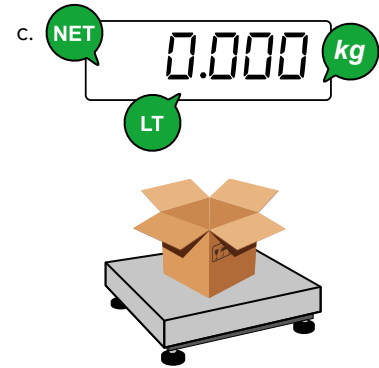
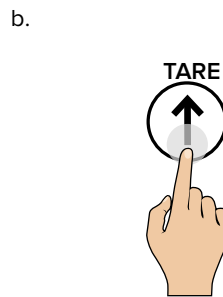
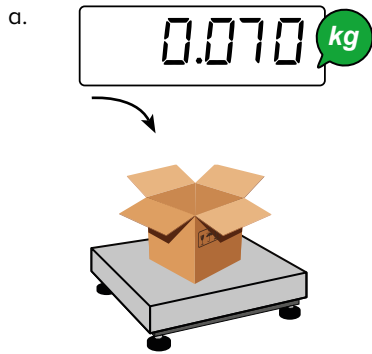

How to set the value



With the numerical keyboard, the combination of the **(F) + 5** keys allows to type the desired quantity (in any amount).

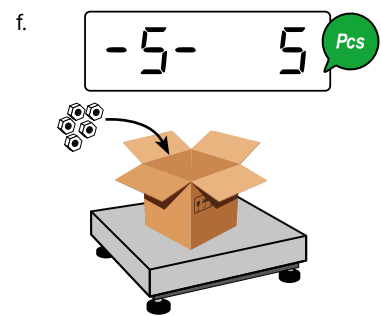

Load the selected reference quantity

For a correct sampling, the reference quantity must have a weight of at least 0.1% of the maximum scale capacity.

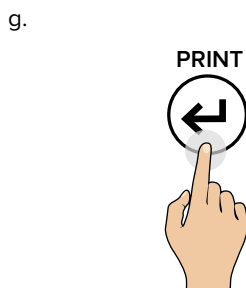

* With the numerical keyboard, the combination of the **(F) + 7** keys allows to modify the sampling time. The more the time, the more the sampling precision.

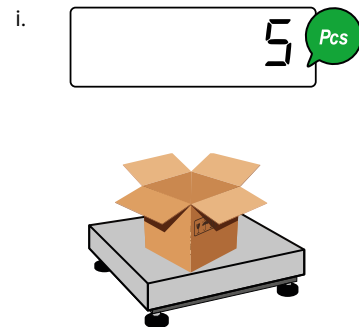

COUNTING - Count



How to switch between pieces count and weight

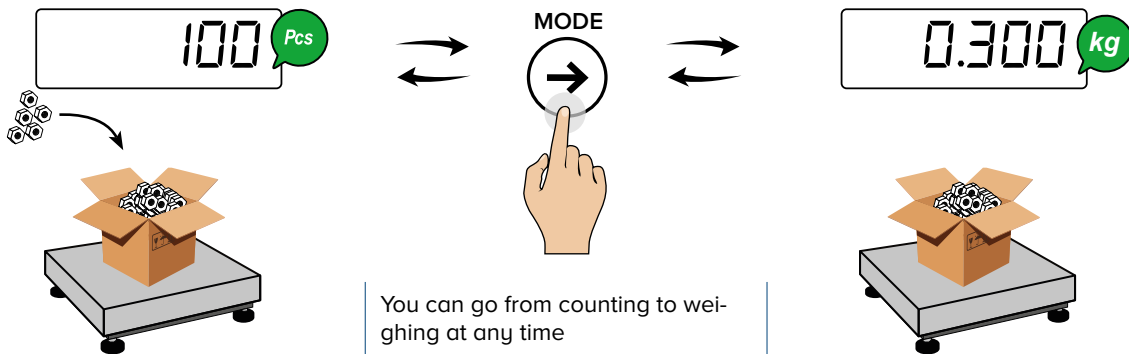

How to enter the average unit weight (PMU)

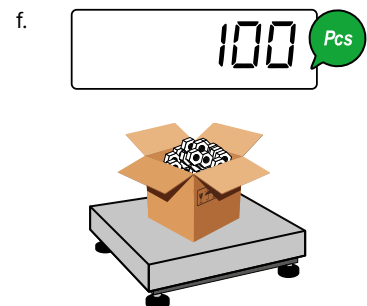
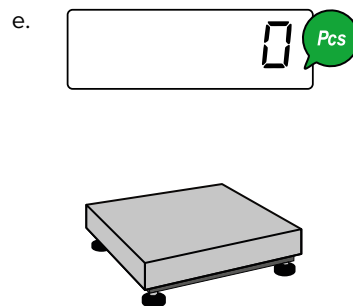
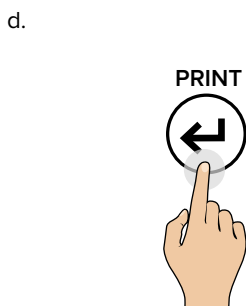
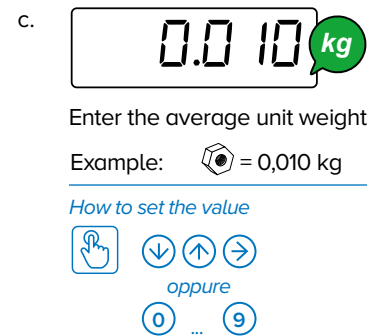
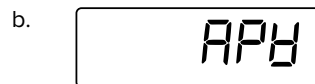
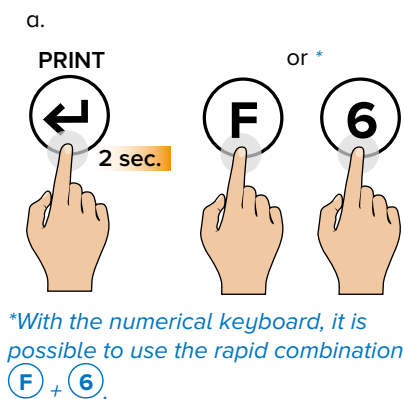

For correct counting, you must set the known tare value (see page 15) or tare the empty container and fill it with the pieces to count.



COUNTING - Count

Pieces counting of the total load

a.

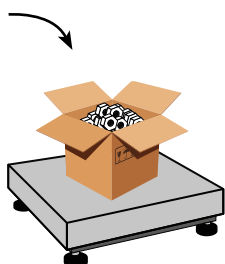

b. Insert the tare value



How to set the value

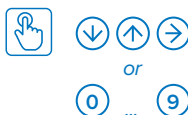

c.

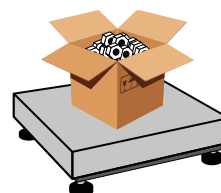

d.

e.

Select the desired reference quantity (5, 10, 20, ... 200 pieces)

How to set the value



With the numerical keyboard, the combination of the **F** + **5** keys allows to type the desired quantity (in any amount).

f. Take the samples (5, 10, 20, 30, 40, 50, 60, 75, 100, 200 pezzi).

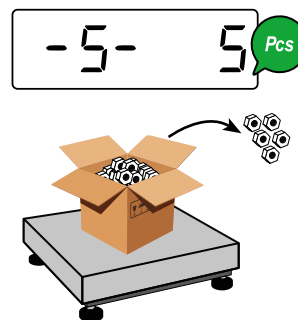

g.

h.

Sampling in progress, please wait...

* With the numerical keyboard, the combination of the **F** + **7** keys allows to modify the sampling time. The more the time, the more the sampling precision.

i.

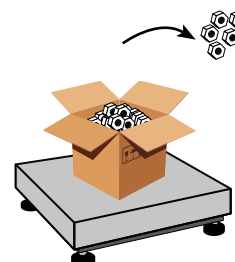



WEIGHT CHECK - CHECK

How to start the check with known reference weight

a.

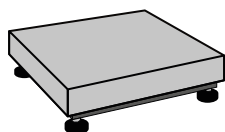

b.

c.

d.

How to set the value



e.

f.

Enter the lower tolerance

How to set the value

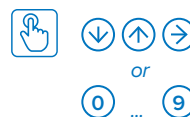

g.

h.

Enter the higher tolerance

How to set the value



i.

Example 1

To check a weight of 1000 g with +/- 5 g tolerance (that is, between 995 g and 1005 g), set:

t0 1000
L 00005
h 00005

Example 2

To check a weight of 500 g with + 10 g / - 20 g tolerance (that is, between 480 g and 510 g), set:

t0 0500
L 00020
h 00010



WEIGHT CHECK - CHECK

How to start the check with automatic target acquisition

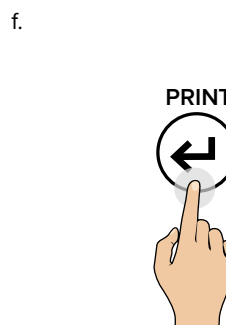
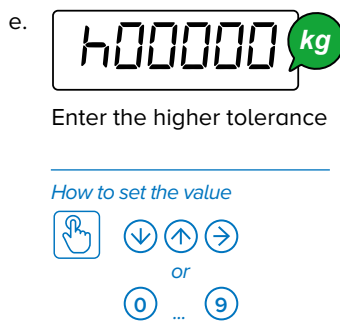
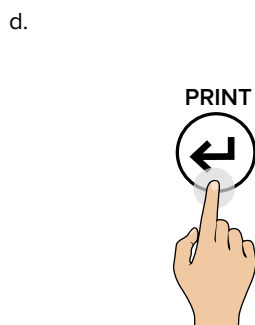
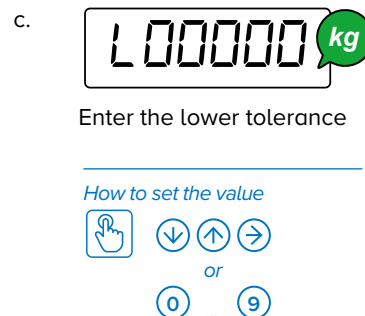
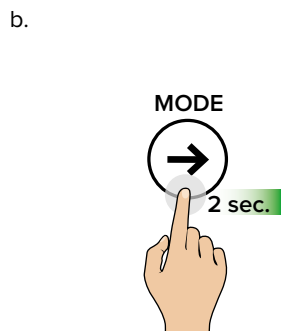
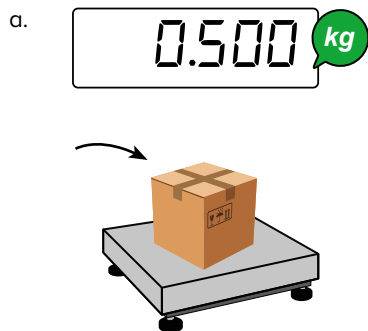

How to check the weight

- of -

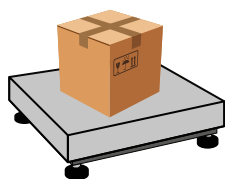

_ under

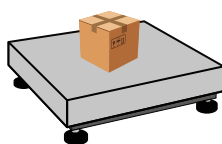

- over

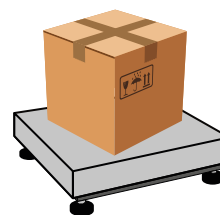



WEIGHT CHECK - CHECK

How to update the nominal weight with known reference weight

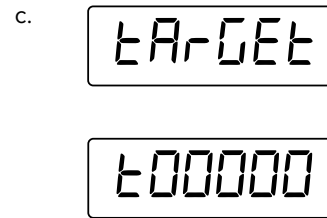
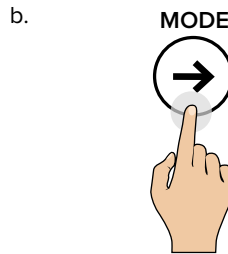
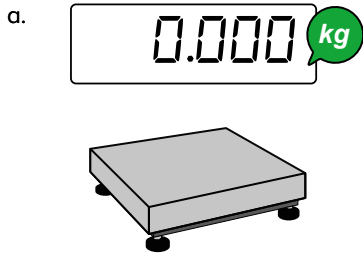

How to update the nominal weight with automatic target acquisition

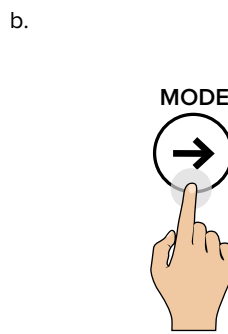
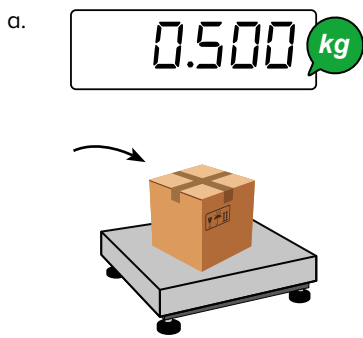

How to edit the check thresholds

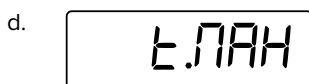
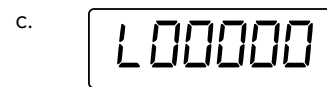
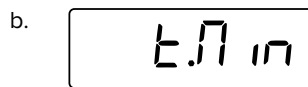
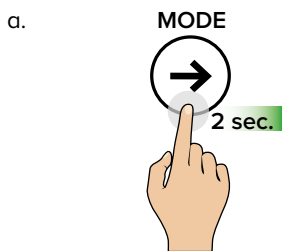



UNIT OF MEASUREMENT CONVERSION - ConUEr

How to convert the unit of measurement into pounds (standard mode)

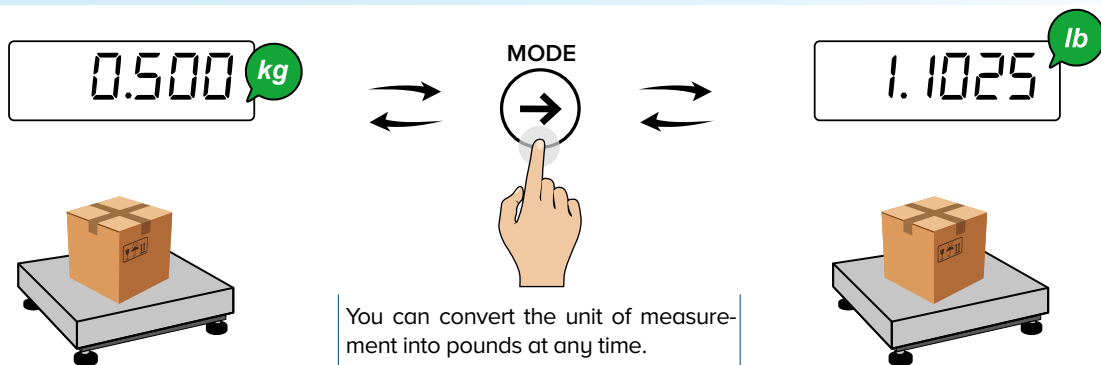

Converting the unit of measurement with free conversion factor

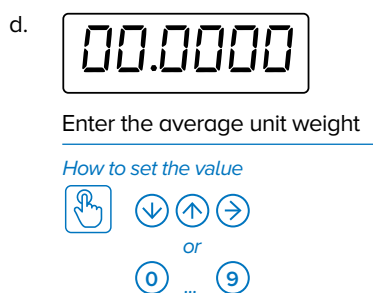
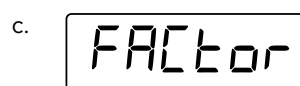
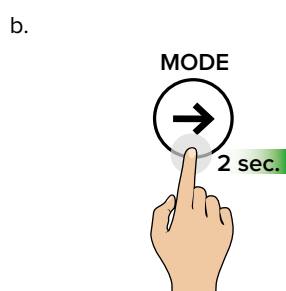

Pounds (lb)	1g = 0.00220
Ounces (oz)	1g = 0.03527
Stones (st)	1g = 0.00016
Karats (kt)	1g = 5.00000
Grains (gr)	1g = 15.43240
...	

Any conversion factor must be multiplied to the weight.

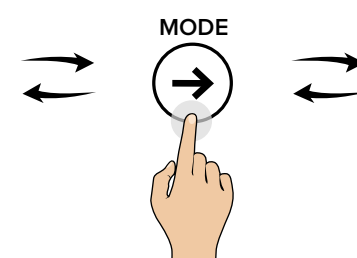
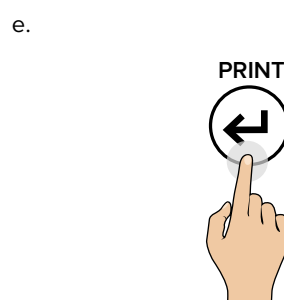

You can convert the unit of measurement with free conversion factor at any time.

PERCENTAGE WEIGHING - PErC



Percentage check

I. How to acquire the 100% reference

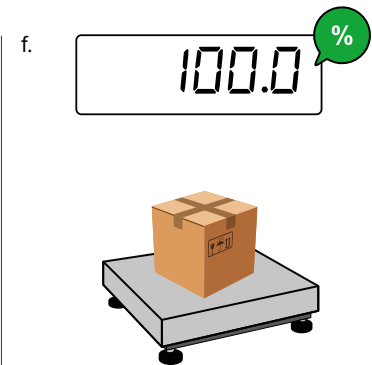
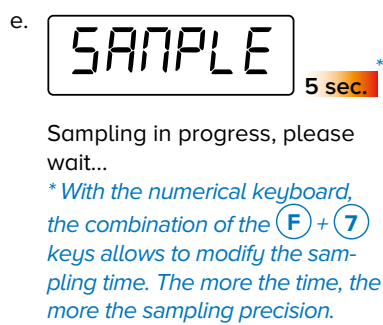
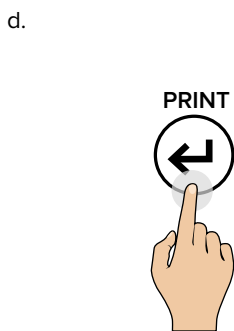
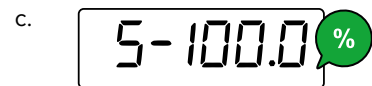
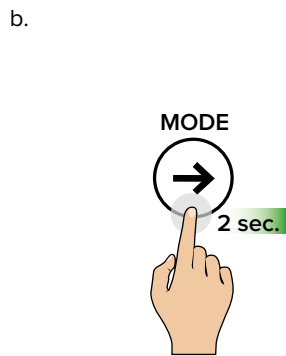
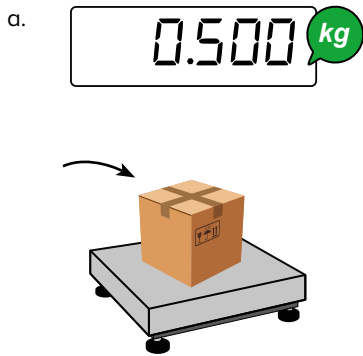

II. How to check the weight

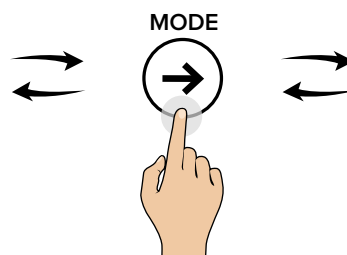
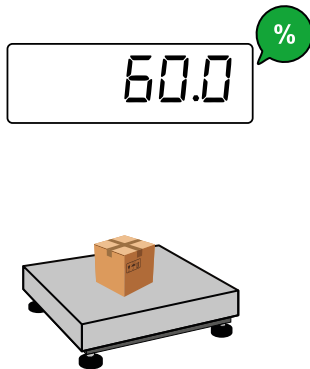

You can go from weight in % to weight in kg at any time.





PERCENTAGE WEIGHT - PErC

Percentage metering

Example of formula

Product: RP28K
 1. 2127A3 - 50%
 2. 23AB4 - 30%
 3. Water - 20%
Dose 500g

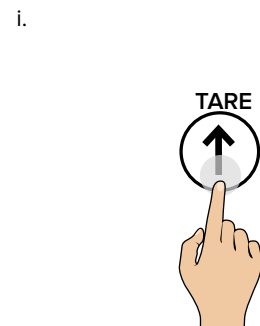
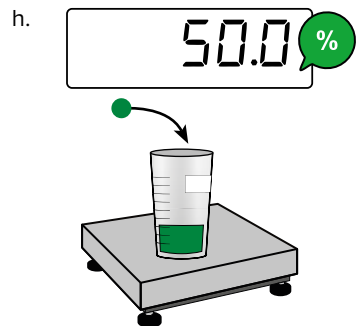
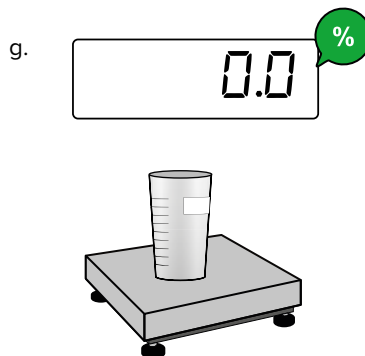
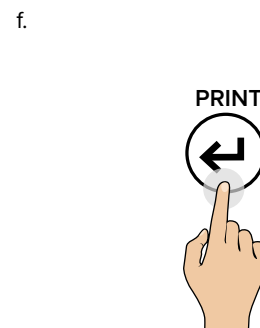
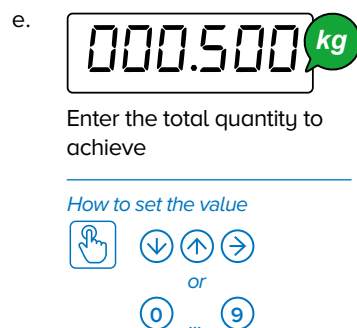
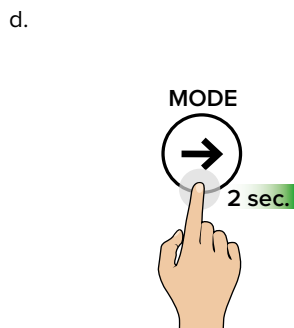
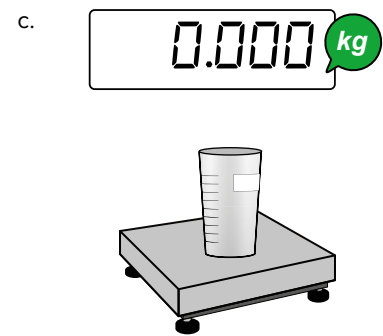
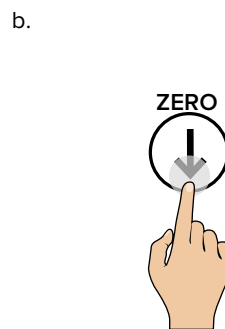
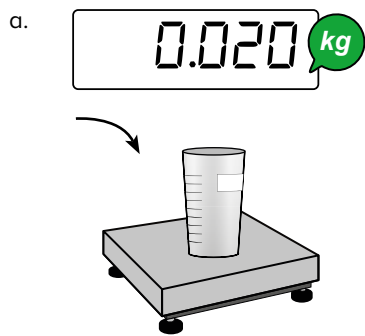

PERCENTAGE WEIGHT - PERCENT

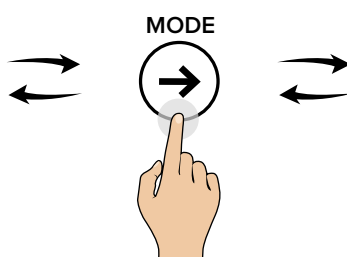
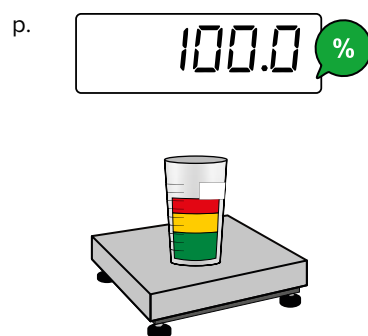
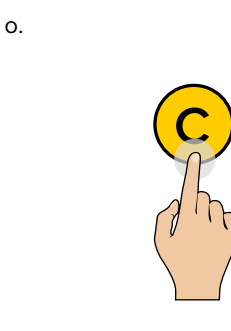
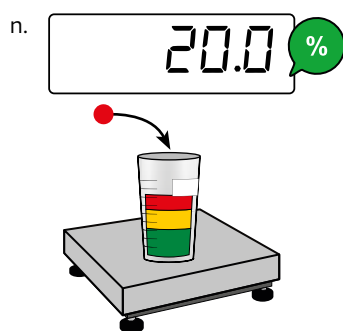
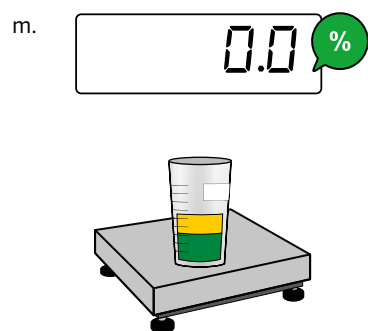
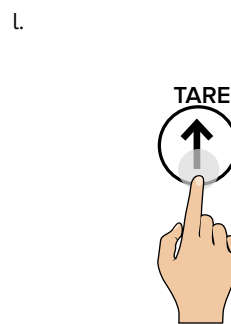
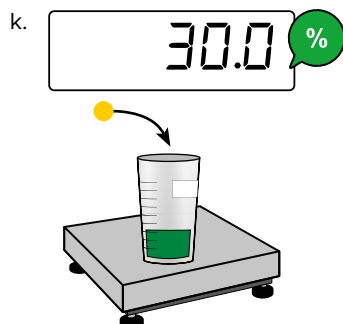
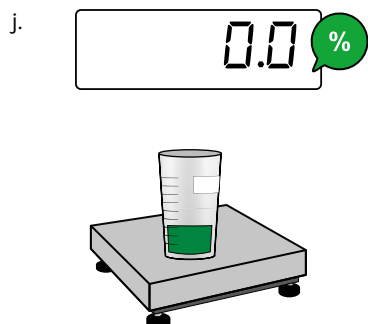

You can go from weight in % to weight in kg at any time.





HOLDING WEIGHT ON THE DISPLAY - hold

How to activate the function

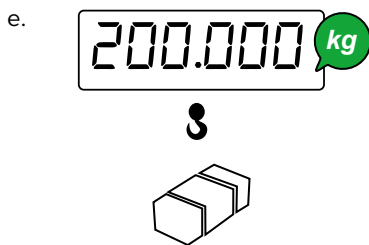
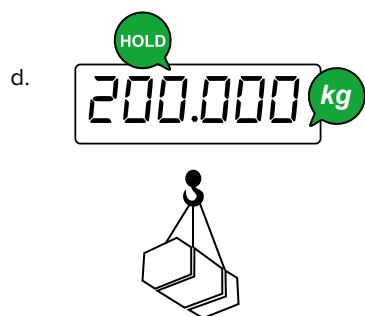
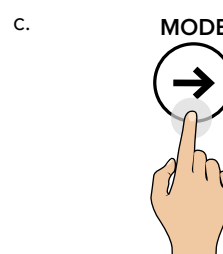
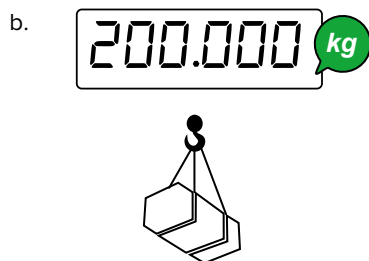
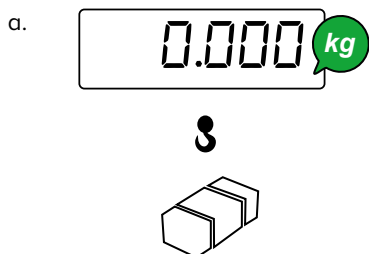

The weight on the display is held even when the scale is unloaded.

How to deactivate the function

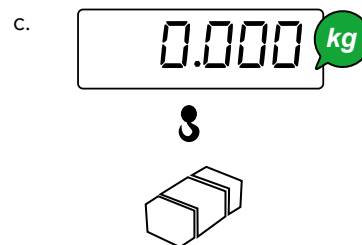
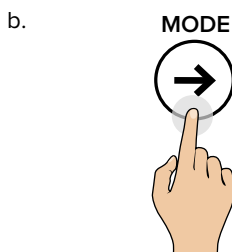
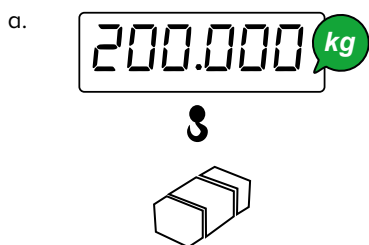

EXCHANGE BETWEEN NET WEIGHT AND GROSS WEIGHT - *net.Gro*

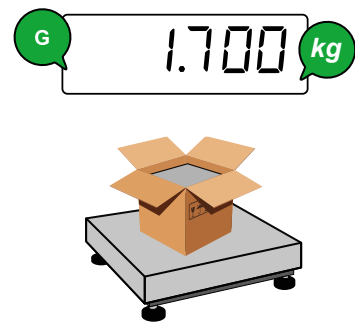
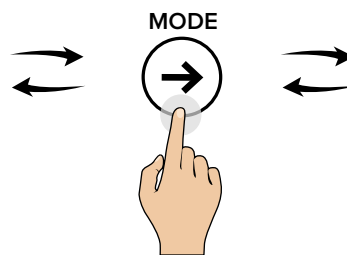
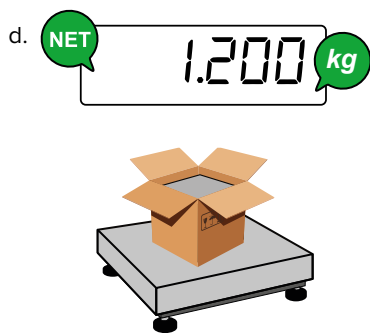
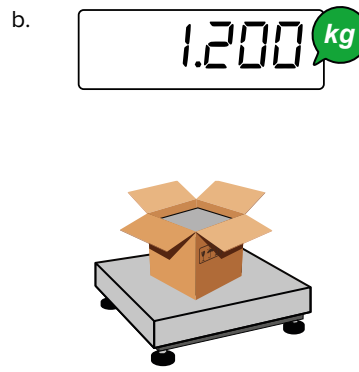
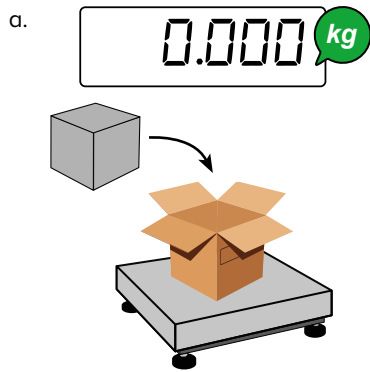
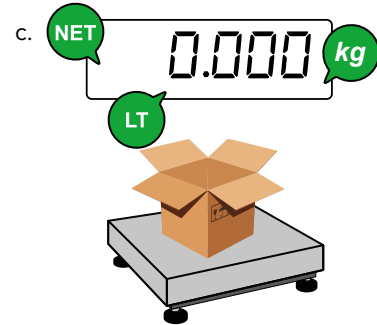
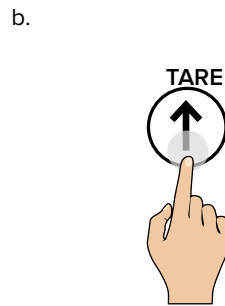
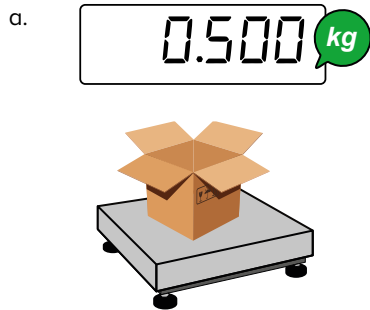

You can go from net weight to gross weight at any time.

i

If there is a tare weight, the gross weight is displayed for 2 seconds. While the gross weight is displayed, printing is not possible.

CONFIGURATION MENU

of the scale

How to access the configuration menu	44
Date and time (CLoCF).....	45
High resolution reading division (PREC. ID).....	45
Alibi memory reading (ALibi).....	46
Relay output (SEEPnt).....	46
Weighing filters (FILTEr).....	47
Display backlighting (SCREEn).....	48
Tare (tARE).....	49
Automatic switching off (AutoOFF).....	49
Manual printer swiching on (on.PRin).....	49
Ticket number reset (tIn.rES).....	50
Factory configuration reset (rESEt).....	50
Diagnostics (dIAL).....	50

HOW TO ACCES THE CONFIGURATION MENU

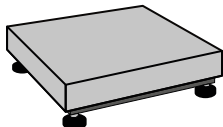
a.  

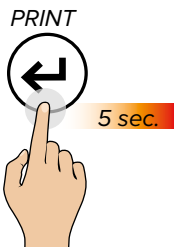
b. 

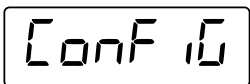
c.  The indicator is in the configuration menu.



MENU

How to enter

1. 5 Sec.



How to browse

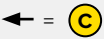
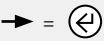
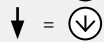
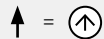

Page 44

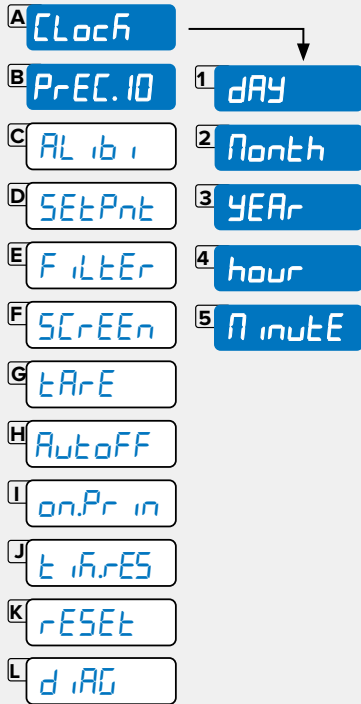

CLock - DATE AND TIME



Visible only if the date/time option is available

Day

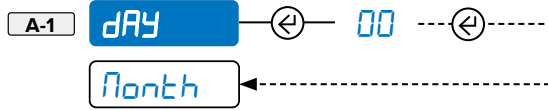

Month

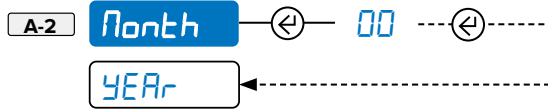

Year

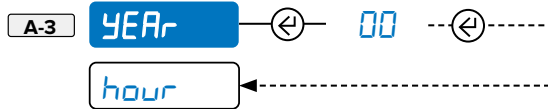

Hour

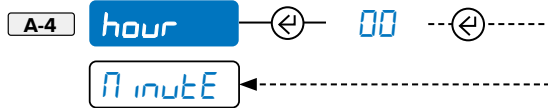

Minute

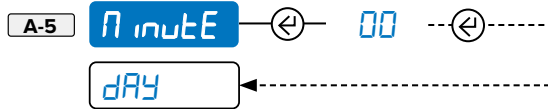

PrEC.10 - HIGH RESOLUTION READING DIVISION



This functions allows you to display the weight with ten times greater resolution

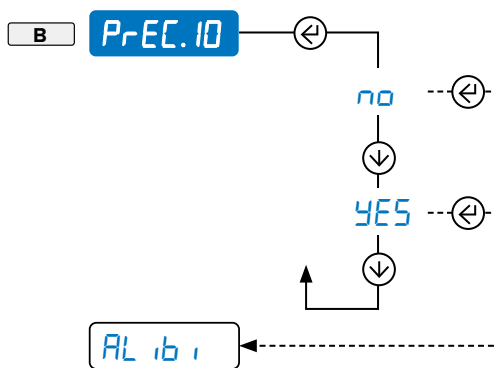

How to enter

1. 5 Sec.



i Page 44

How to browse

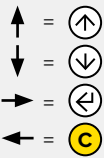

- A CLock
- B PrEC.10
- C **ALibi**
- D SEtPnt
- E FiLter
- F SCrEEn
- G tArE
- H AutoFF
- I onPr in
- J tArES
- K rESEt
- L dAG

ALibi - ALIBI MEMORY READING



Visible only if there is an optional board

The weighing save ID code is expressed as follows: 00000 - 000000, for example 00001 - 000021.

The first value is the re-write number, the second value is the weighing identification number.

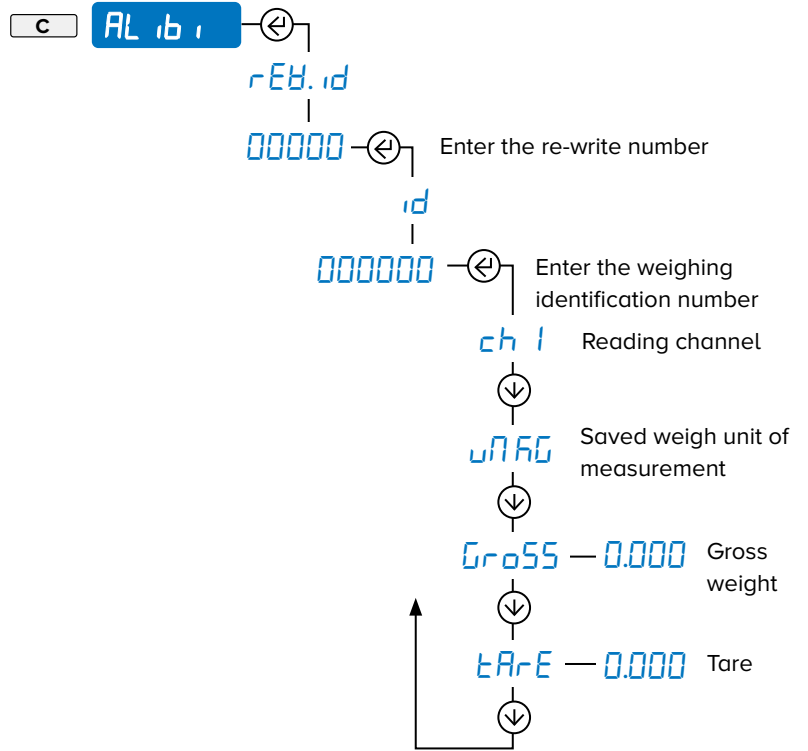

SEtPnt - RELAY PORTS



Visible only if there is an optional board

Relay port activation/deactivation weights

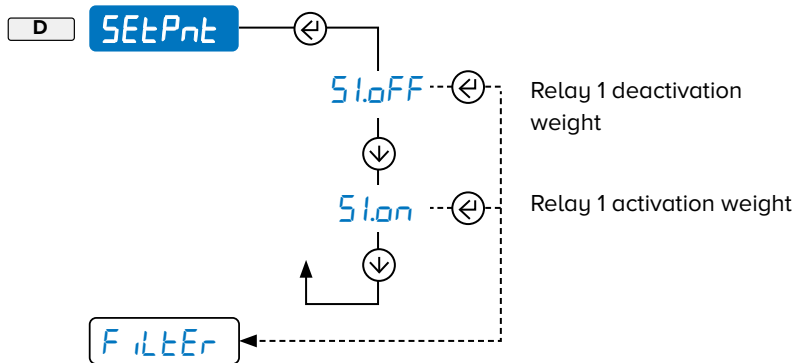

i Repeat the same operation for relays 2, 3 and 4.



MENU

How to enter

1. 5 Sec.



Page 44

How to browse

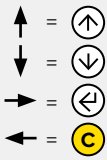

- A CLock
- B PrEC.10
- C ALib1
- D SEtPnt
- E **FiltEr**
- F SCrEEen
 - 1 StAnd.0
 - ...
 - 4 StAnd.3
 - 5 h irES.0
 - ...
 - 12 h irES.7
 - 13 dyn.0
 - ...
 - 16 dyn.3
 - 17 SLoB.0
 - ...
 - 20 SLoB.3
 - 21 doS.0
 - ...
 - 24 doS.3
 - 25 rAdC 0
 - ...
 - 28 rAdC 5
- G tArE
- H AutoFF
- I onPr in
- J t irES
- K rESEt
- L d iAG

FiltEr - WEIGHING FILTERS



Edits scale reactivity.

Useful in optimising weighing to your needs.



With the approved instrument, you can select only some of the filters listed below.

Premise

The "0" represents minor filtering incidence.

Increasing the incidence give the weight more stability.

We recommend weighing several times, changing the incidence until you obtain the best compromise between reactivity and stability.

Table and floor scales and piece counters

E-1

StAnd.0

...

E-4

StAnd.3

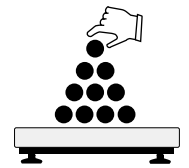
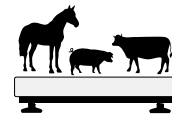

High precision scales

E-5

h irES.0

...

E-12

h irES.7



Suspended and oscillating load weighing

E-13

dyn.0

...

E-16

dyn.3



Liquid weighing, weighbridges and weighing with vibrations

E-17

SLoB.0

...

E-20

SLoB.3

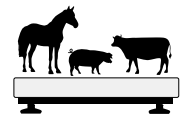
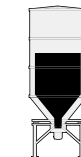

Metering, filling, level check and overloads

E-21

doS.0

...

E-24

doS.3



Auto



Manual

Filter for specific applications for use by the manufacturer

E-25

rAdC 0

...

E-28

rAdC 5



MENU

How to enter

1. 5 Sec.



Page 44

How to browse



A CLock

B PrEC.10

C ALib1

D SEtPnt

E FiltEr

F SCrEEen

G tArE

H AutoFF

I onPr in

J tArES

K rESEt

L dAG

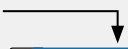

1 bARL it

2 br iGht

3 LoCh

4 CoLour

SCrEEen - ADJUSTING THE DISPLAY



Backlighting

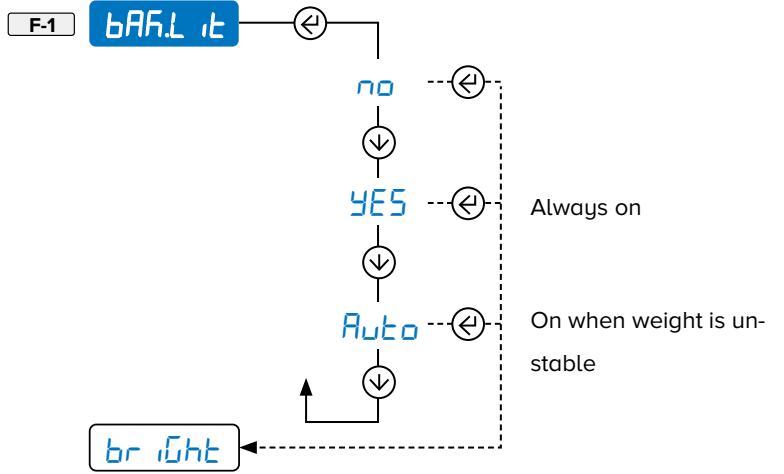

Brightness

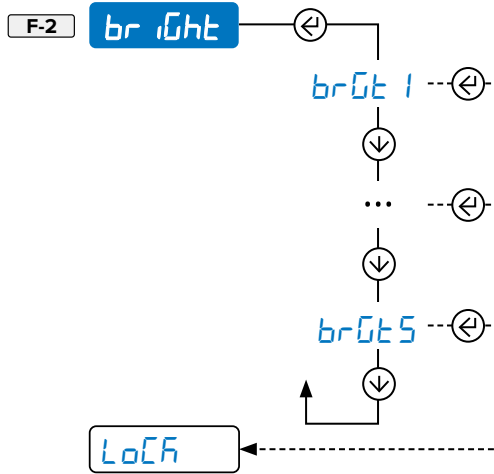

Display lock (for use by the manufacturer)

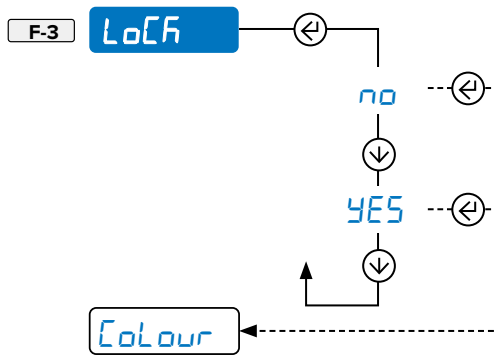

Backlighting colour

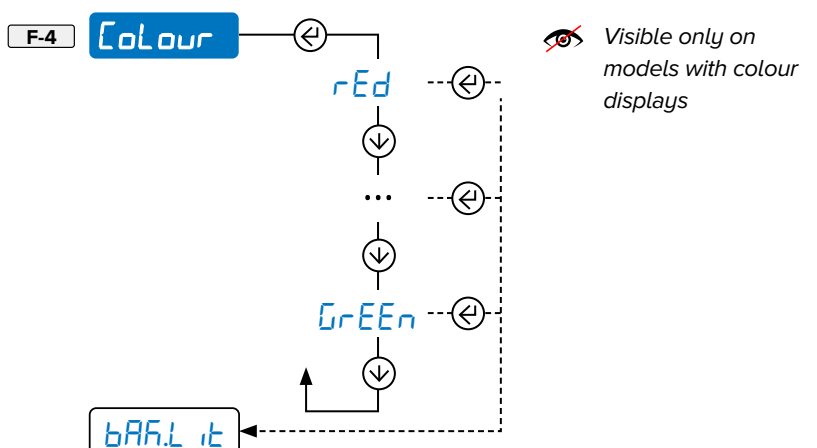



MENU

How to enter

1. 5 Sec.



Page 44

How to browse

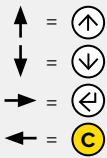

A CLock

B PrEC.10

C ALib1

D SEtPnt

E FiltEr

F SCrEEr

G tArE

H AutoFF

I on.Pr in

J t.r.rES

K rESEt

L d.rG

tArE - TARE

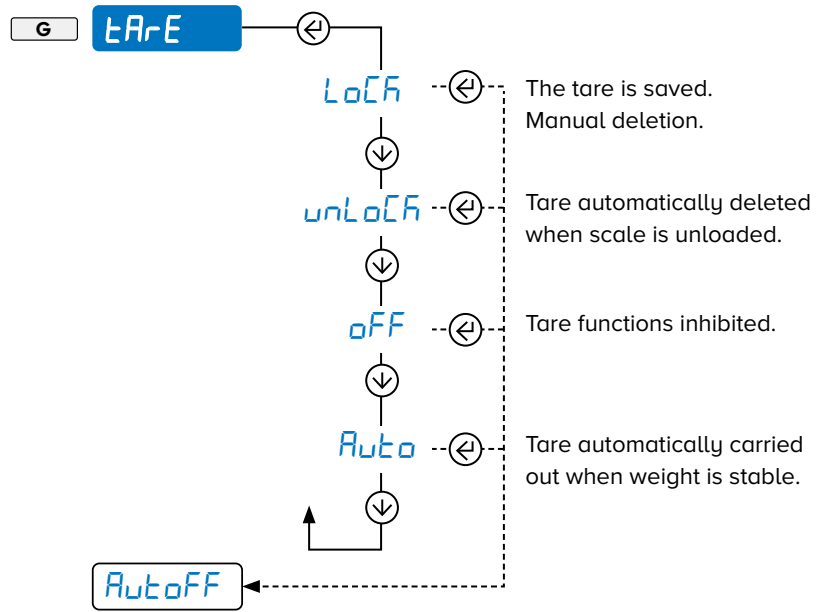

AutoFF - AUTOMATIC SWITCHING OFF

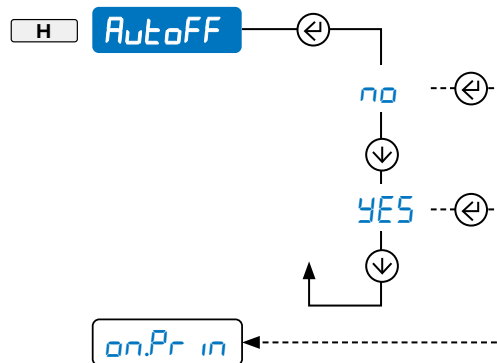

on.Pr in - MANUAL PRINTER SWITCHING ON



Visible only if there is an integrated printer.

I on.Pr in Manual Vaux port switching on (switching on printer, radio module or other device powered via Vaux)

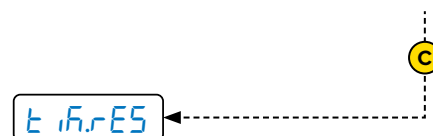



MENU

How to enter

1. 5 Sec.



Page 44

How to browse



A **CLock**

B **PrEC.10**

C **ALib1**

D **SEtPnt**

E **FILtEr**

F **SCrEEr**

G **tArE**

H **AutOFF**

I **onPr in**

J **t iN.rES**

K **rESEt**

L **d iAG**

t iN.rES - TICKET NUMBER RESET

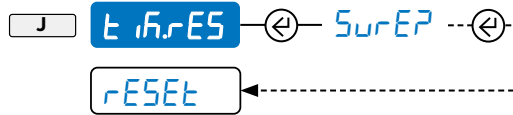

rESEt - FACTORY CONFIGURATION RESET

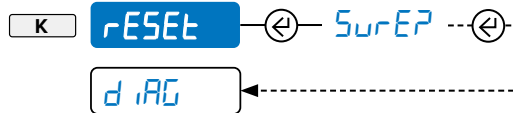

d iAG - DIAGNOSTICS



L **d iAG** ← Reserved for technical staff.

FAQ

Frequently Asked Questions

Print.....	51
Accumulation	51
Tare	51
Weighing.....	52
Piece counter	52

PRINT

The scale does not print

- Another printout is already in progress (bUSY)
- Make sure there is a roll in the printer
- The printer does not switch on
- The weight is unstable (UNStAb)
- The net or gross weight is negative or is insufficient for printing (LoH)
- Underload or overload (----- o -----) (UN.OVER)
- The scale was not loaded after the last printing (no . 0 . UN5)
- You are trying to print a non-approved weight

ACCUMULATION

The scale does not accumulate

- Make sure there is a roll in the printer
- The printer does not switch on
- The weight is unstable (UNStAb)
- The net or gross weight is negative (LoH)
- Underload or overload (----- o -----) (UN.OVER)
- The scale was not unloaded after the last printing (no . 0 . UN5)
- The weight is insufficient for weighing (LoH)
 - less than 10 divisions for the accumulator modes
 - less than "Min" for the approved products (shown on the measuring plate)

The scale has lost the total

- Switching off the scale causes the accumulated totals to be lost

TARE

The scale does not tare

- The weight is unstable (UNStAb)
- The gross weight is negative (LoH)
- The weight is insufficient
- The weight exceeds the maximum capacity
- The tare function has been deactivated (see page 49)
- In the event of manual tare, the value exceeds the maximum capacity

WEIGHING

The scale does not switch on

- Make sure the power cable is connected properly
- Connect the battery charger and try again. If the instrument continues to malfunction, contact the dealer.

The scale switches off suddenly

- Automatic switching off active
- Low battery
- Battery failure
- Power supply line failure

The scale is not reactive

- One of the available energy saving modes has been activated
- An unsuitable weighing filter has been selected

The scale display switches off and displays a dot

- Stand-by mode is active: press a key to reactivate weighing.
- Energy saving mode is active: contact the dealer for further details.

The scale displays a permanent "Err" message

- The scale is unable to automatically reset the weight because it exceeds the maximum resettable weight at switch-on.
- Unload the scale and try again. If the scale continues to have the same problem even when there is nothing on it, contact the dealer.

The weight is unstable

- Check the active weighing filter (*see page 47*).
- If the support surface is subjected to vibrations from machinery or moving vehicles, move the scale onto another surface and try again.

PIECE COUNTER

The scale does not carry out sampling

- The weight is unstable (*Err. NoE*)
- The weight is insufficient, add more pieces and try again (*Error*)

ERROR MESSAGES

MESSAGE	DESCRIPTION	SOLUTION
<i>buSy</i>	Another printout is already in progress	Wait for the printout in progress to be finished and try again.
<i>unStAb</i>	The weight is unstable	Check the weighing filter (see page 35). If the support surface is subjected to vibrations from machinery or moving vehicles, move the scale onto another surface and try again.
<i>LoH</i>	The net or gross weight is negative or insufficient for printing	Add weight and try again.
<i>un.oVer</i>	Underload o overload (____ o _____)	Restore a valid weight condition. If the problem persists, contact customer service.
<i>no.O.unS</i>	The scale was not unloaded after the last printing	Completely unload the scale, making sure the →0← light comes on. Reload the weight and try again.
<i>Err.NoSt</i>	The weight is unstable	Wait for stability (the ~ light) and try again.
<i>Error</i>	In piece counting mode, the weight is insufficient for proper sampling.	Add more pieces and try again.

TECHNICAL NOTES - CONFIGURATION OF THE PRODUCT

To be completed by the technical service.

NOTES

FuncT	_____	_____
PrEC.10	<input type="checkbox"/> no <input type="checkbox"/> YES	_____
SEtPnt	S1.off _____	_____
	S1.on _____	_____
	S2.off _____	_____
	S2.on _____	_____
	S3.off _____	_____
	S3.on _____	_____
	S4.off _____	_____
	S4.on _____	_____
FILtEr	_____	_____
ScREEn	bAA.L it <input type="checkbox"/> no <input type="checkbox"/> YES <input type="checkbox"/> Auto	_____
	br ighT _____	_____
	LoCk _____	_____
	CoLour _____	_____
tArE	<input type="checkbox"/> LoCk <input type="checkbox"/> unLoCk <input type="checkbox"/> oFF <input type="checkbox"/> Auto	_____
AutoFF	<input type="checkbox"/> no <input type="checkbox"/> YES	_____

This publication, or portions thereof, may not be duplicated without written permission from the Manufacturer. All information contained in this manual is based on the data available at the time of its publication; the Manufacturer reserves the right to make changes to its products at any time without notice and without incurring any penalty. We therefore recommend that you always check for any updates.

The individual in charge of the scale operation must ensure that all safety regulations in force in the country of use are applied, ensuring that the appliance is used in accordance with the purpose it is intended for and to avoid any danger for the user.

The Manufacturer declines any liability arising from any weighing operation errors.



HEAD OFFICE

Via Della Fisica, 20
41042 Spezzano di Fiorano, Modena - Italy
Tel. +39.0536 843418 - Fax. +39.0536 843521
info@diniargeo.com

SERVICE ASSISTANCE

Via Dell'Elettronica, 15
41042 Spezzano di Fiorano, Modena - Italy
Tel. +39.0536 921784 - Fax. +39.0536 926654
service@diniargeo.com