

# SCT-1SX Series

*Firmware version 01.21.01*

## Operation Manual



© Rice Lake Weighing Systems. All rights reserved.

Rice Lake Weighing Systems® is a registered trademark of  
Rice Lake Weighing Systems.

All other brand or product names within this publication are trademarks or  
registered trademarks of their respective companies.

All information contained within this publication is, to the best of our knowledge, complete  
and accurate at the time of publication. Rice Lake Weighing Systems reserves the right to  
make changes to the technology, features, specifications and design of the equipment without  
notice.

The most current version of this publication, software, firmware and all other product  
updates can be found on our website:

[www.ricelake.com](http://www.ricelake.com)

## Revision History

This section tracks and describes manual revisions for awareness of major updates.

Revision	Date	Description
A	January 4, 2024	Initial Release
B	January 6, 2025	Minor Updates

<b>Introduction</b>	<b>7</b>
<b>Transmitter Installation</b>	<b>8</b>
Installation Requirements	8
Electrical Precautions	9
System Grounding	11
Technical Features	15
Load Cell Installation	16
<b>Wiring Diagrams</b>	<b>17</b>
SCT-1SX-AN	17
SCT-1SX-E/IP, SCT-1SX-PRONET, SCT-1SX-MODTCP	18
<b>Display and Key Functions</b>	<b>19</b>
<b>Quick Menu</b>	<b>19</b>
<b>Advanced Programming Menu</b>	<b>20</b>
Access the Advanced Menu and Save Changes	20
Menu Key Function	20
Menu Block Diagram	21
<b>Theoretical Calibration</b>	<b>23</b>
<b>Calibration with Sample Weights</b>	<b>24</b>
<b>Manual Calibration</b>	<b>26</b>
<b>Quick Zero Calibration (Pre-tare Reset)</b>	<b>26</b>
<b>ADC Converter Precalibration</b>	<b>27</b>
<b>Filter and Stability</b>	<b>27</b>
Filter adjustment	27
Anti-peak Filter	28
Stability Detection Divisions	28
Stability Detection Time	29
Additional Filter for Stability Detection	29
<b>Gravity</b>	<b>30</b>

<b>Reset Functions and Parameters</b>	<b>31</b>
Auto-zeroing on Start-up	31
Maximum Percentage of Manual Zeroing	31
Zero Tracking	32
Zero Tracking Time	32
Restoring Zero	32
Semi-automatic Zeroing	32
<b>Tare Functions and Parameters</b>	<b>33</b>
Tare Mode	33
Semi-automatic tare	33
Predetermined Tare	33
Clearing the Tare	33
Restoring the Tare	33
<b>Alibi Memory</b>	<b>34</b>
Enabling the Alibi Memory	34
Saving a Weighing Operation in the Alibi Memory	34
Reading the Alibi Memory	35
Initializing the Alibi Memory	35
<b>Use Functions</b>	<b>36</b>
High Resolution	36
Peak Detection	36
Converting Units of Measure	36
Alibi Memory	36
<b>Input Configuration</b>	<b>37</b>
<b>Output Configuration</b>	<b>38</b>
<b>Analog Output Configuration</b>	<b>39</b>
<b>Serial Communication Configuration</b>	<b>41</b>
USB port Configuration	41
485 Port (PC port) Configuration	42

<b>Communication Protocols</b>	<b>43</b>
Standard String	43
Extended String	43
Serial Commands	44
Modbus Protocol	47
<b>Diagnostics</b>	<b>49</b>
<b>Programming the Setpoints</b>	<b>50</b>
<b>Restoring Factory Settings</b>	<b>51</b>
<b>Alarms</b>	<b>52</b>

# Introduction

Thank you for purchasing this product.

This manual contains instructions for correct installation and commissioning of the SCT-1SX digital weight transmitters, including the following SCT-1SX models::

- SCT-1SX-AN
- SCT-1SX-PRONET
- SCT-1SX-E/IP
- SCT-1SX-MODTCP

Also, this manual provides information on the correct operation and maintenance of the weigh transmitter. It is essential to pay the close attention to operation procedures.

It is recommended that you carefully follow the instructions for programming the weight transmitter; performing actions not indicated in this manual could compromise the functionality of the scale.



Manuals are available from Rice Lake Weighing Systems at [www.ricelake.com/manuals](http://www.ricelake.com/manuals)

Warranty information is available at [www.ricelake.com/warranties](http://www.ricelake.com/warranties)

Any problem with the product must be reported to the manufacturer or to the retailer where it was purchased.  
Always TURN OFF THE POWER SUPPLY prior to installation or repair action.

## Installation Requirements

Observe the following conditions for correct installation of the transmitter and the load receiver:

- Flat, level support surface.
- Stability and absence of vibrations.
- Absence of aggressive dusts and vapor.
- Absence of drafts.
- Ensure the platform is level or that the load cells are evenly supported.
- Moderate temperature and humidity: 59°F - 86°F (15°C - 30°C) and 40% - 70%.
- Do not install in an environment where there is a risk of explosion.
- All transmitter connections must be made in accordance with applicable regulations in the area and environment of installation. Read the electrical precautions listed in the section “**Electrical Precautions**”.
- Ensure the system is correctly grounded, see the relevant section “**System Grounding**”.
- Do not perform welding when the load cells have already been installed.
- If necessary, use watertight sheaths and fittings to protect the load cell cables.
- Any junction boxes must be watertight.
- Anything not expressly described in this manual constitutes improper use of the equipment.



## Electrical Precautions

- Use a regulated mains supply within  $\pm 10\%$  of the rated voltage.
- The electrical protections (*fuses, etc.*) are the responsibility of the installer.
- Observe the recommended minimum distances between cables of different categories (**see table on page 10**).
- The following cables must comply with the maximum permissible lengths (**see table on page 10**), they must be shielded and must be inserted alone in metal conduits or pipes:
  - the load cell extension cables;
  - the signal amplifier cables;
  - the cables for connecting the serial ports;
  - the analog output cables.
- The cell or amplifier cables must have an independent input in the electrical panel. They must be connected (if possible) directly to the terminal block of the transmitter without passing through the conduit with other cables.
- Fit "RC" filters:
  - on the contactor coils;
  - on the solenoid valve coils;
  - on all devices that produce electrical interference.
- If condensation can occur inside the weight transmitter, it is advisable to keep the equipment powered at all times.
- Connections to load cells and any external device must be as short as possible.
- The cable ends (connectors, leads, terminals, etc.) must be installed correctly; the cable shielding must be kept intact until close to the connection point.
- If the transmitter is placed inside an electrical panel, a shielded cable must also be used for the power supply.

**RECOMMENDED DISTANCES AND CABLE CLASSIFICATION**

	Category I	Category II	Category III	Category IV
<b>Distance</b>				
<b>Classification</b>	Fieldbus, LAN network (PROFIBUS or Ethernet).  Shielded data cables (RS232...).  Shielded cables for analog digital signals < 25 V (sensors, load cells...).  Low voltage power supply cables (< 60 V).  Coaxial cables.	DC supply cables with voltage > 60 V and < 400 V.  AC supply cables with voltage > 25 V and < 400 V.	Power supply cables with voltage > 400 V.  Telephone cables.	Any cable subject to lightning danger.

**MAXIMUM ALLOWED LENGTHS**

Load cell	RS232	RS485	Analog output
164 ft (50 m) with 6 x 24 AWG (0.25 mm <sup>2</sup> ) cable;  328 ft (100 m) with 6 x 22 AWG (0.5 mm <sup>2</sup> ) cable.	49 ft (15 m) with baud rate up to 19200.	3937 ft (1200 m) with shielded 2 x 24 AWG twisted pair with outer braid + aluminium strip.	<b>CURRENT:</b> <ul style="list-style-type: none"> <li>• 328 ft (100 m) with 2 x 24 AWG (0.25 mm<sup>2</sup> cable);</li> <li>• 492 ft (150 m) with 2 x 22 AWG (0.5 mm<sup>2</sup> cable);</li> <li>• 984 ft (300 m) with 2 x 17 AWG (1 mm<sup>2</sup> cable).</li> </ul> <b>VOLTAGE:</b> <ul style="list-style-type: none"> <li>• 164 ft (50 m) with 2 x 24 AWG (0.25 mm<sup>2</sup> cable);</li> <li>• 246 ft (75 m) with 2 x 22 AWG (0.5 mm<sup>2</sup> cable);</li> <li>• 150 meters with 2 x 17 AWG (1 mm<sup>2</sup> cable).</li> </ul>

# System Grounding

For correct earthing and optimal system operation, the transmitter, load cells, junction box, if any, and weighing structure must be earthed.

## TRANSMITTER

The earth connection must be made via the appropriate terminal. The cable cross-section must be less than 14 AWG (2.5 mm<sup>2</sup>). The transmitter must be powered by a dedicated power supply with earth reference. Do not connect EARTH and GND terminals together!

SCT-1SX Correct earth connection

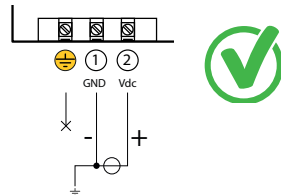

SCT-1SX Incorrect earth connection

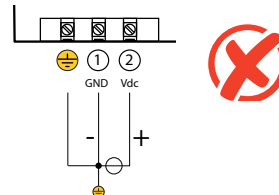

## LOAD CELLS AND JUNCTION BOX

The connection must be made by connecting the ground cables to the ground bar (cables that must have a cross-section of at least 6 AWG/16 mm<sup>2</sup>); finally, connect the earth bar to the earth post with a cable having a cross-section of at least 1-1/0 AWG (50 mm<sup>2</sup>).

### EXAMPLES:

- If more load cells are connected to the transmitter through a junction box, the cable shield from the transmitter and the cell cable shields must be connected to the earth socket of the junction box (refer to the junction box manual) and the junction box must be earthed using a copper cable with a cross-section of not less than 6 AWG (16 mm<sup>2</sup>).
- If the load cell is connected directly to the transmitter (without using the junction box), the cell cable shields must be connected to the earthing point (or earth bar).
- If the weighing system involves large and/or outdoor structures (weighbridges, silos, etc.) and the distance between the junction box and the weight transmitter is greater than 33 ft (10 m), connect the cell cable shields to the earth socket in the junction box.

## WEIGHING STRUCTURE

Earth the weighing structure and/or any unconnected structures (e.g. silos that release material onto the weighing structure) using cables with a cross-section of not less than 6 AWG (16 mm<sup>2</sup>).

Also connect the upper part with the lower part of each cell by means of a copper braid with a cross-section not less than 6 AWG (16 mm<sup>2</sup>) (refer to the grounding examples on page 12 and page 13).

## SERIAL CABLES AND CONNECTED INSTRUMENTS

Connect the serial cable shield to the earthing point (or earth bar) inside the panel. To avoid any undesired effects, the earth reference of the connection cable, power supply and transmitter must be at the same potential.

**GENERAL NOTES:**

- All earth cables must be of suitable length, so as to obtain an overall resistance of the earthing system of less than 1  $\Omega$ .
- If the weighing system involves large and/or outdoor structures (weighbridges, silos, etc.):
  - the earth connection must be made by connecting the earth cables to an earth bar and the earth bar to the earth post with a cable having a cross-section of not less than 1-1/0 AWG (50 mm<sup>2</sup>);
  - the earth post must be placed at a distance of at least 33 ft (10 m) from the structure.
- If the load receiver is more than 33 ft (10 m) from the transmitter, we recommend using the SENSE line and load cells equipped with a (SENSE) compensation circuit.

**EXAMPLE OF GROUNDING OF A WEIGHBRIDGE**

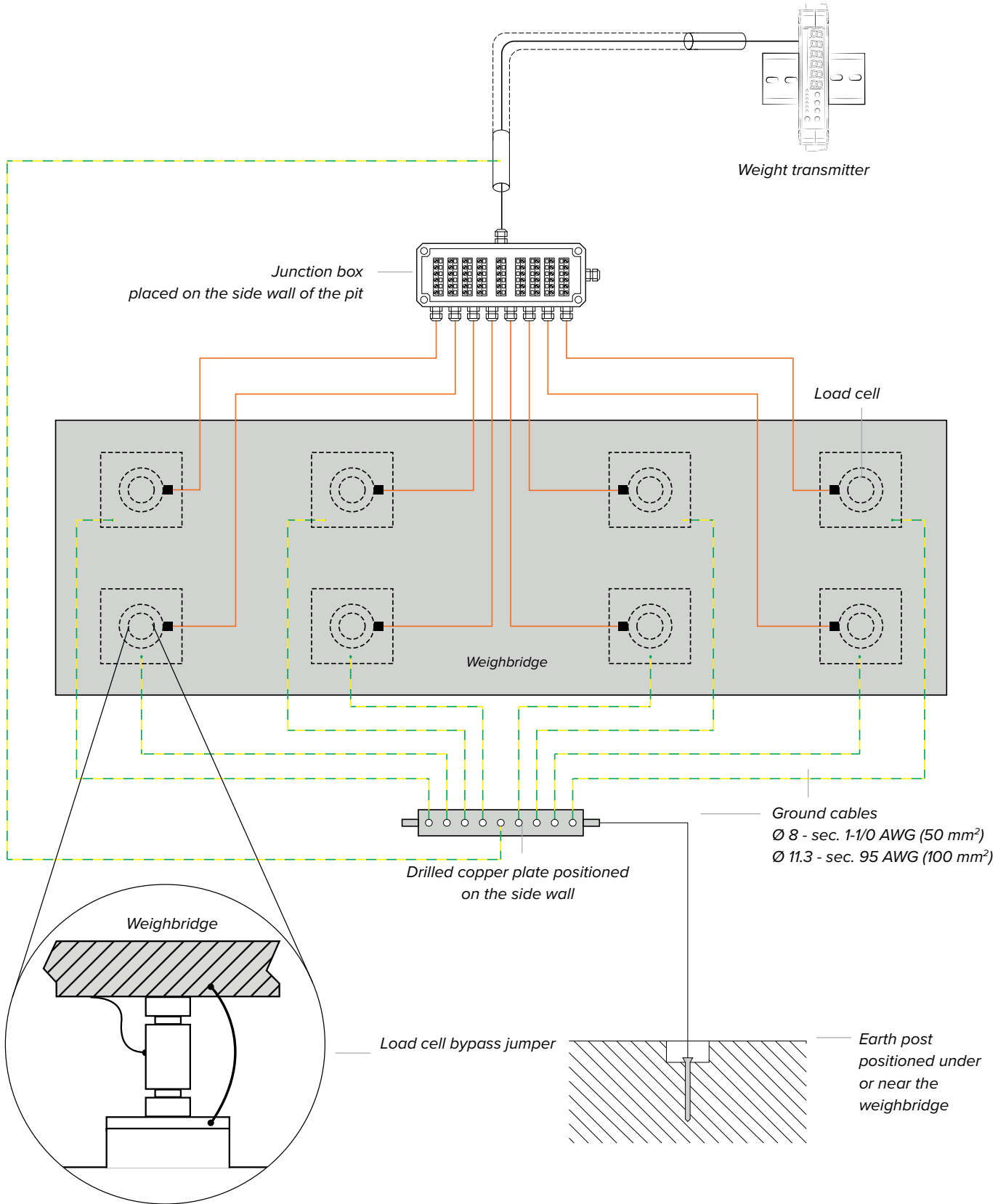

EXAMPLE OF EARTHING OF A SILO

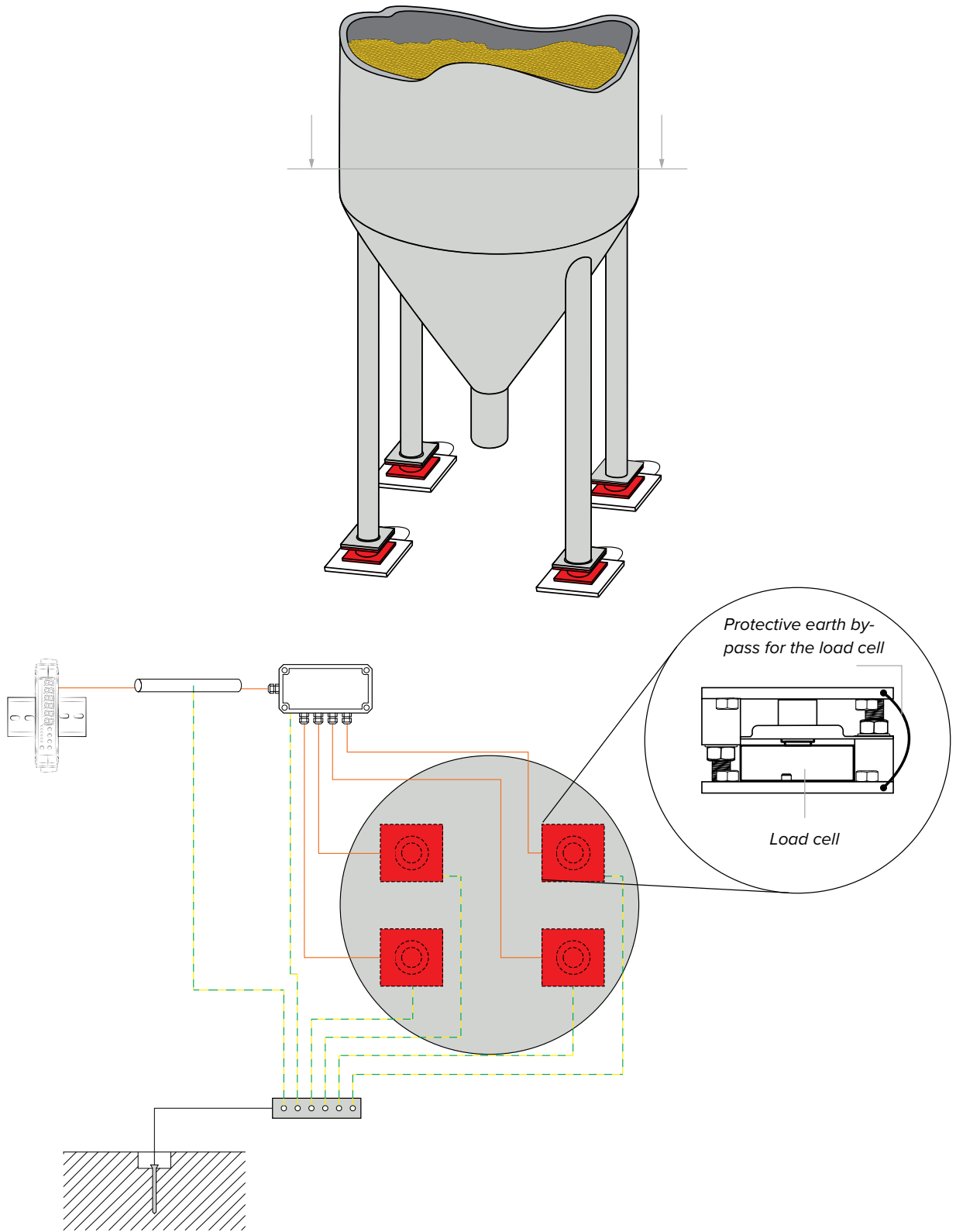

## Technical Features

<b>POWER SUPPLY</b>	12 - 24 VDC LPS or with class 2 power supply.
<b>MAXIMUM ABSORPTION</b> (without load cells)	<ul style="list-style-type: none"> <li>SCT-1SX-AN: 2 W</li> <li>SCT-1SX-E/IP, SCT-1SX-PRONET, SCT-1SX-MODTCP: 4 W</li> </ul>
<b>OPERATING TEMPERATURE</b>	From 14°F to 104°F (-10°C to +40°C)
<b>DISPLAY DIVISIONS</b>	10000e, 2 x 3000e for legal weighing, expandable up to 800,000 for internal use (with a minimum cell signal of 1.6 mV/V)
<b>CONVERSION SPEED</b>	Up to 4800 conversions / sec
<b>MINIMUM VOLTAGE PER DIVISION</b>	0.3 $\mu$ V ( <i>restricted transmitter</i> ); 0.03 $\mu$ V ( <i>non-restricted transmitter</i> ).
<b>COUNTING RESOLUTION</b>	1,500,000 points (with input signal 3 mV/V)
<b>DISPLAY</b>	6 digits, 0.3 in (8 mm) high
<b>SIGNALS</b>	6 status indicator LED lights
<b>KEYPAD</b>	mechanical with 5 keys
<b>TARE FUNCTION</b>	Subtraction possible over the entire range
<b>LOAD CELL POWER SUPPLY</b>	5 VDC, 250 mA
<b>LOAD CELL CONNECTION</b>	6 wires or 4 wires
<b>CONNECTABLE CELLS</b>	Up to 16 350 $\Omega$ cells
<b>CASE</b>	Made of plastic (ABS), suitable for DIN rail mounting (EN 60715 - DIN43880) or wall mounting
<b>SERIAL OUTPUTS</b>	<ul style="list-style-type: none"> <li>1 half duplex RS485 bidirectional port on terminal (SCT-1SX-AN)</li> <li>2 ETHERNET ports (SCT-1SX-E/IP, SCT-1SX-MODTCP, SCT-1SX-PRONET)</li> <li>1 USB port (micro USB type B) <math>\rightarrow</math> Virtual COM (Device)</li> </ul>
<b>OUTPUTS / INPUTS</b>	<ul style="list-style-type: none"> <li>4 photomosfet NO or NC outputs: max 60 VDC 0.5 A max / 48 VAC 0.5A;</li> <li>2 configurable inputs (bidirectional optocouplers): 12 - 48 VDC;</li> <li>Input reading and output update time: 1 msec;</li> <li>16-bit analog output (SCT-1SX-AN only).</li> <li>Current: 0 - 20 mA / 4 - 20 mA.</li> <li>Voltage: 0 - 5 VDC, 0 - 10 VDC.</li> </ul> <p>The maximum applicable resistance on the current output is 300 <math>\Omega</math> while the minimum applicable resistance on the voltage output is 1 k<math>\Omega</math>.</p>
<b>LOAD CELL SENSITIVITY</b>	Maximum sensitivity of the connectible load cells: 6 mV/V
<b>FIELD BUS UPDATE RATES</b>	Up to 120 Hz

## Load Cell Installation

After carrying out the instructions for the platform or load receiver, the shielded cable from the cell must be properly connected to the terminal block of the transmitter (see page 17).

The transmitter has one channel for 6-wire connection to load cells (using the REFERENCE).

The REFERENCE allows you to compensate for any voltage drop on the section of cable connecting the transmitter to the load receiver. It is especially useful when the distance between the transmitter and the load receiver is more than 32 ft (10 meters), or in high-resolution applications.

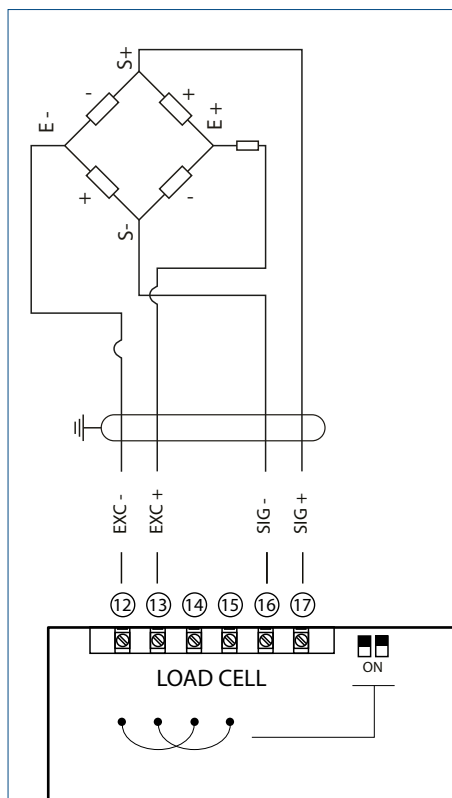

**4-WIRE CONNECTION**

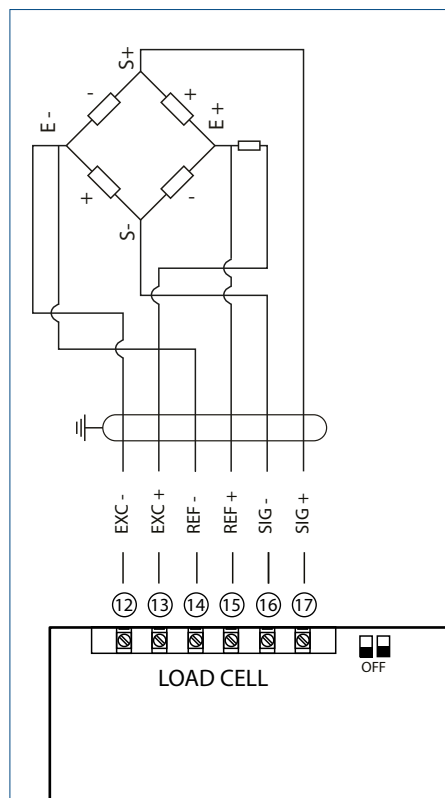

**6-WIRE CONNECTION**



# Wiring Diagrams

## SCT-1SX-AN

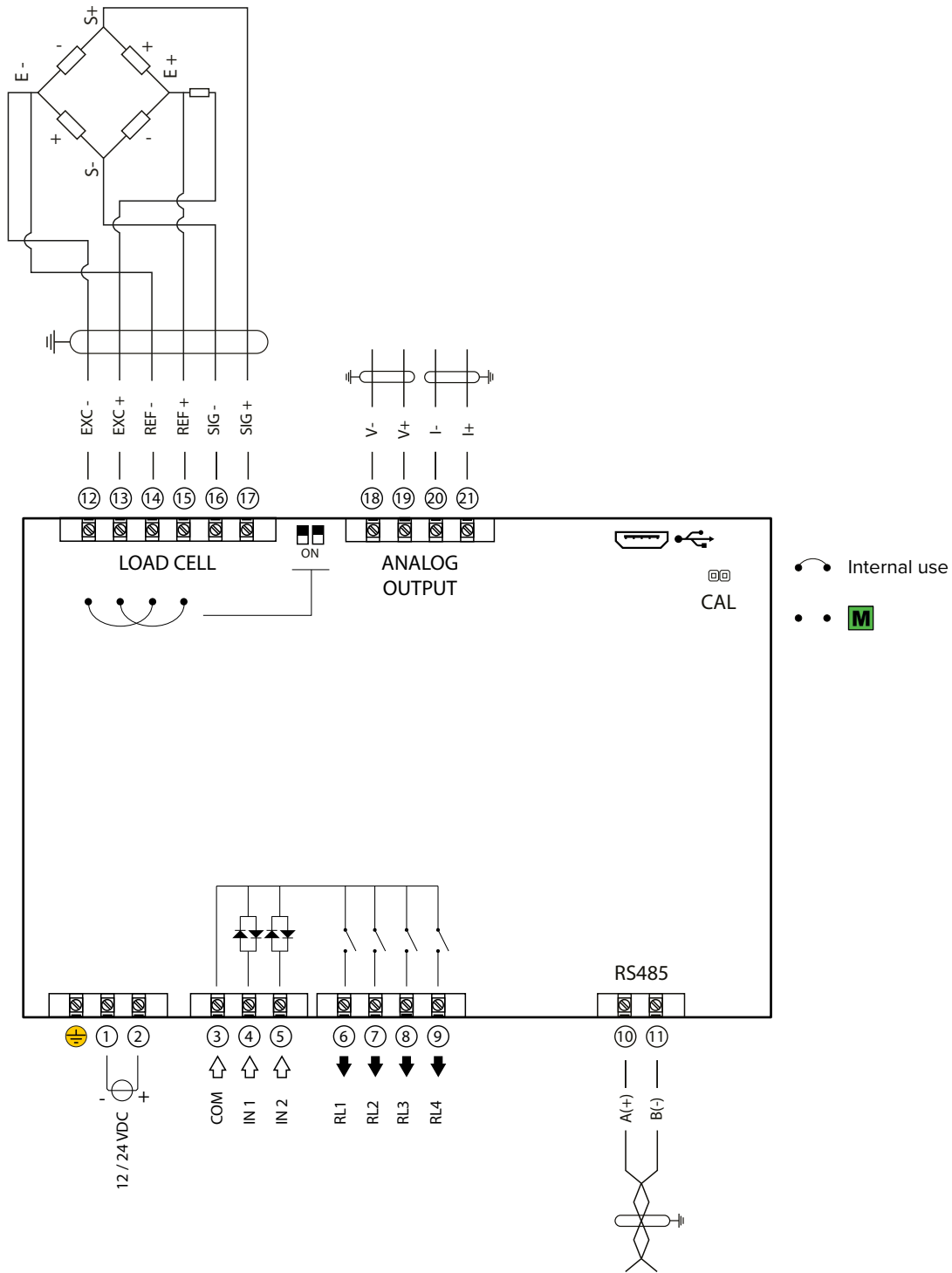

# SCT-1SX-E/IP, SCT-1SX-PRONET, SCT-1SX-MODTCP

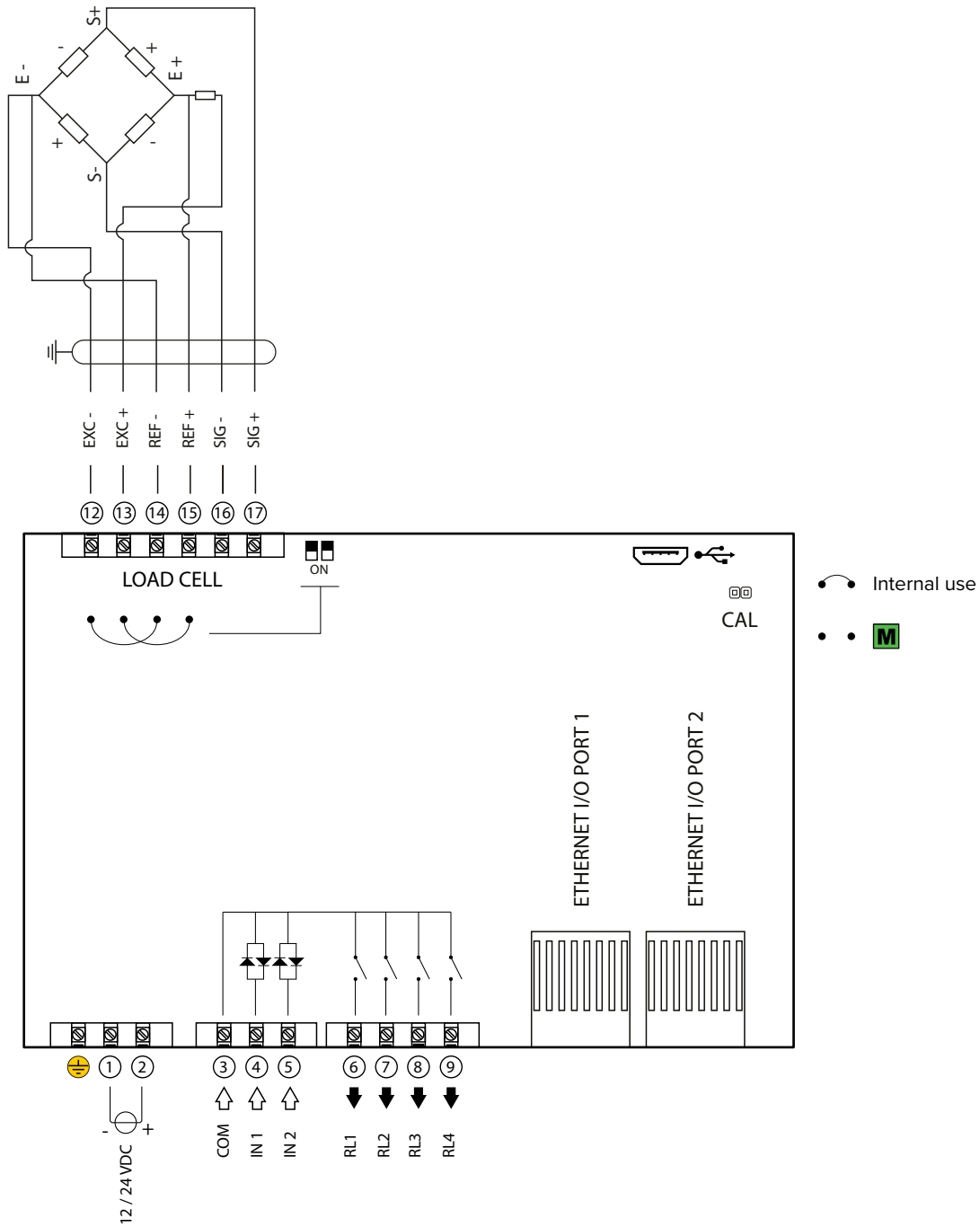

# Display and Key Functions

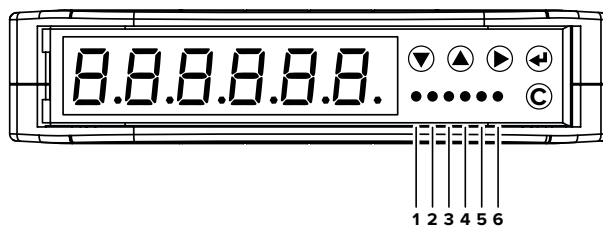

Symbol	Description
▼	Semi-automatic zeroing. Decreases the selected digit.
▲	Semi-automatic tare. Increases the selected digit.
▶	Activates the function. Selects the digit to be changed.
◀	Confirms a value. Prints / Transmits data.
C	Reboots the transmitter.

Number	Description
1	Gross weight on zero.
2	Unstable weight.
3	A tare is active.
4	A special function is active.
5	Output 1 is active.
6	Output 2 is active.

## Quick Menu

The transmitter is equipped with a quick menu, through which you can program the main parameters of the scale. To enter the quick menu, follow the procedure below:

1. Reboot the transmitter.
2. Press the ▶ key when the display shows 000000.



For further information, refer to the transmitter Quick Start Guide.

# Advanced Programming Menu

The advanced menu contains all the transmitter configuration parameters for the most advanced adjustments.

## Access the Advanced Menu and Save Changes

1. Reboot the transmitter.
2. Press the ▲ key when the display shows 888888.



### HOW TO EXIT THE SETUP AND SAVE CHANGES

1. Press C several times, until the display shows "SAVE?".
2. Press ← to save or C to exit without saving.

## Menu Key Function

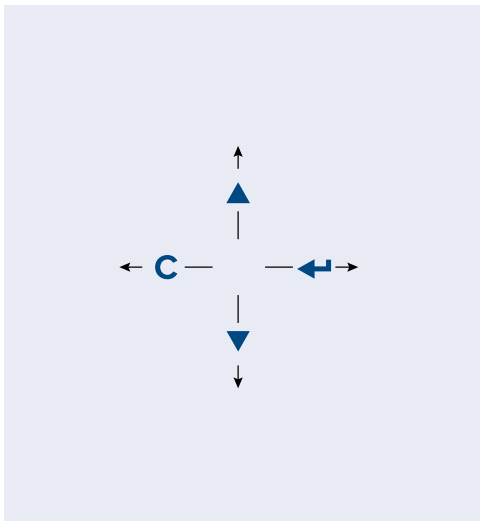

- ▲ Previous parameter.
- ▼ Next parameter.
- ← Access the parameter / confirm setting.
- C Exit a parameter (without saving).

### FUNCTION OF THE KEYS WHEN ENTERING NUMBERS

- ▲ Increases the selected digit.
- ▼ Decreases the selected digit.
- ▶ Selects the next digit.
- ← Confirms the value.
- C Resets the value.  
If pressed again, exits entering.



In the menu description on the following pages the ▼ symbol indicates repeated pressing of the ▼ key until the parameter indicated is reached.



Complete menu  
on pages 21 - 22

#### MENU ACCESS:

888888



Press the ▲ key during the start-up procedure.

#### SAVING THE PARAMETERS:

Press the C key several times, until the display shows SAVE?. Press the ← key to confirm.

# Menu Block Diagram

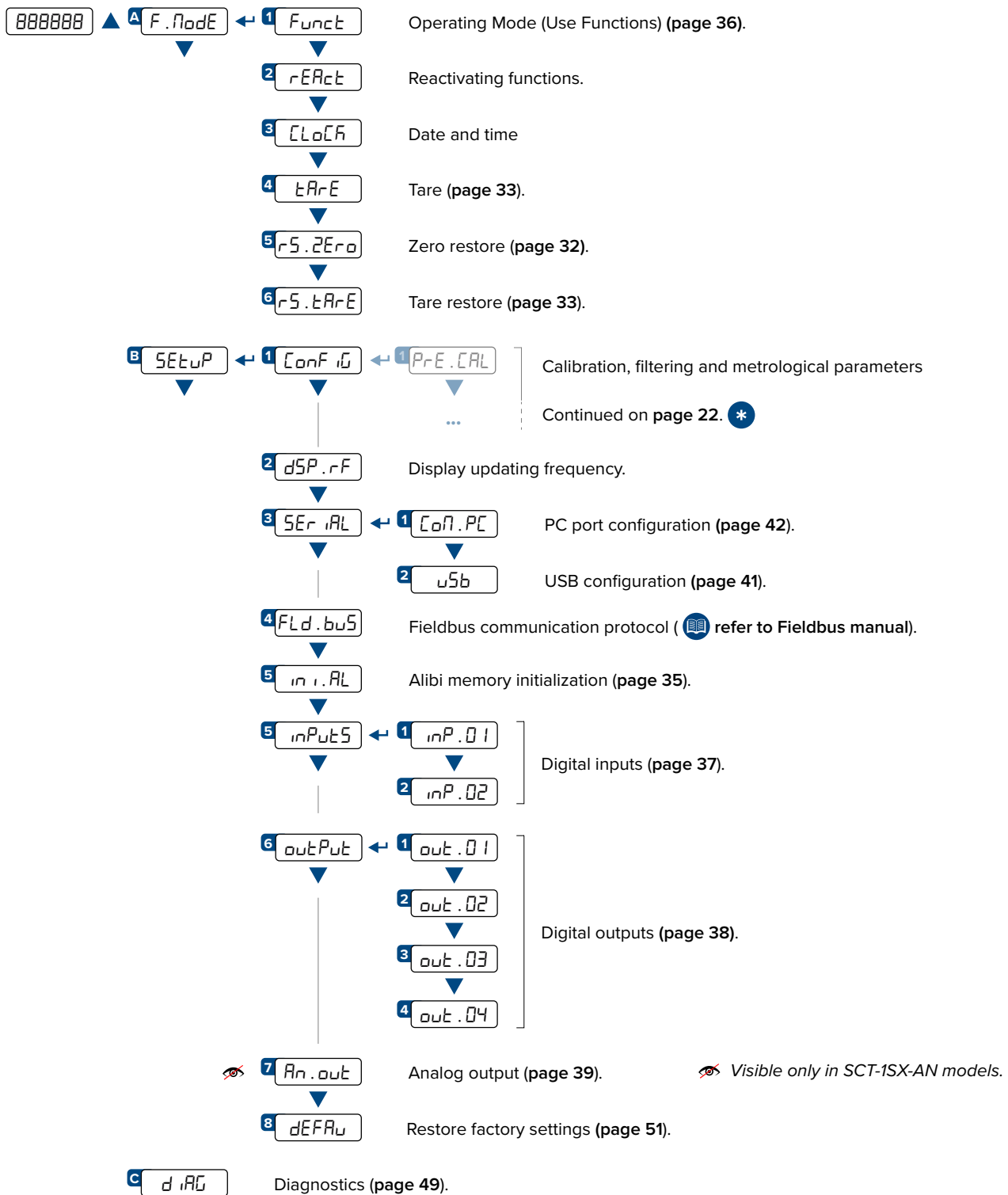

**LEGEND:**



Indicates repeated pressing of the key.



Parameter visible only under certain conditions.



Parameter or menu subject to approval.



Default value of the parameter.

\* Full CONF ID ← SETUP menu is displayed.

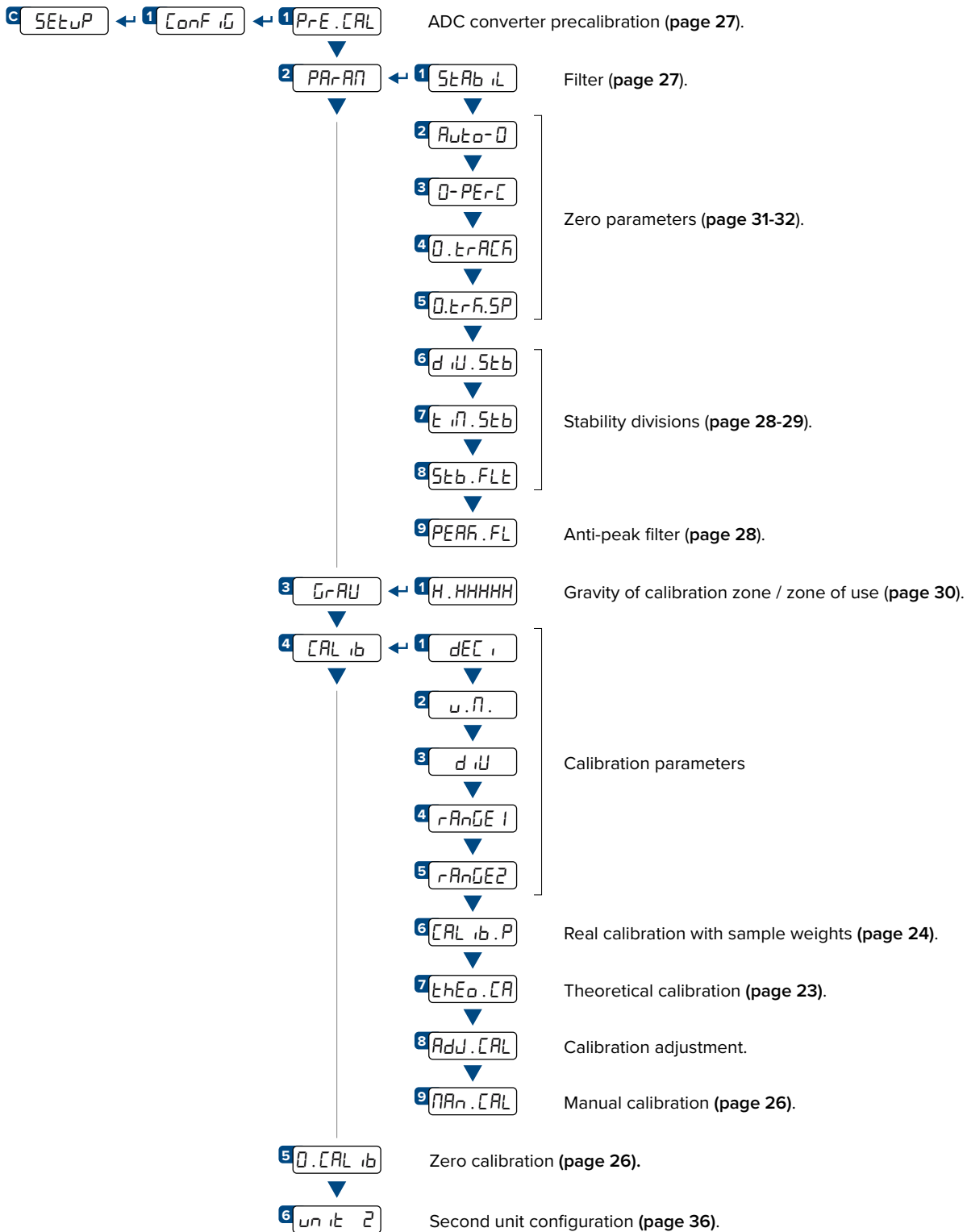

Complete menu on pages 21 - 22

**MENU ACCESS:**

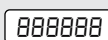

Press the ▲ key during the start-up procedure.

**SAVING THE PARAMETERS:**

Press the C key several times, until the display shows 5AUEP. Press the ← key to confirm.

# Theoretical Calibration

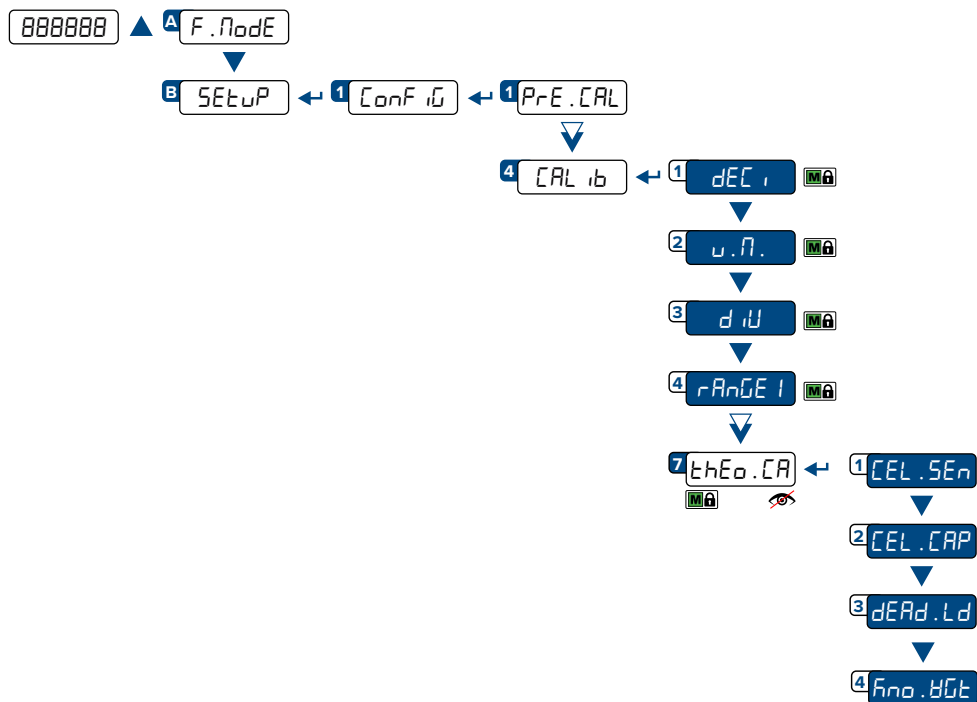

## CALIBRATION PROCEDURE:

### 1. Set the calibration parameters:

- $dEC i$  = Number of decimals.
- $u.n.$  = Unit of measurement (Kg, G, t, Lb).
- $d iU$  = Minimum division.
- $rAnGE I$  = Maximum range.

### 2. Set the cell data:

- $SEn.CEL$  = Cell sensitivity (given by the average mV/V value of cells).
- $CEL.CAP$  = Total capacity of the cells (given by the sum of the capacities of each cell).

### 3. Enter the weight value of the structure in the $dEAd.Ld$ parameter. If you do not know this value, enter "0".

### 4. If the structure contains a quantity of material whose weight value is known (e.g. full silo), enter this value in the $hno.BGt$ parameter.

### 5. Application of theoretical calibration:

Press the **C** key to exit the calibration menu. The display shows  $th.CAL?$ . Press the **←** key to confirm the use of the theoretical calibration, or the **C** key to cancel.

#### LEGEND:



Indicates repeated pressing of the **▼** key.



Parameter visible only under certain conditions.



Parameter or menu subject to approval.



Default value of the parameter.

# Calibration with Sample Weights

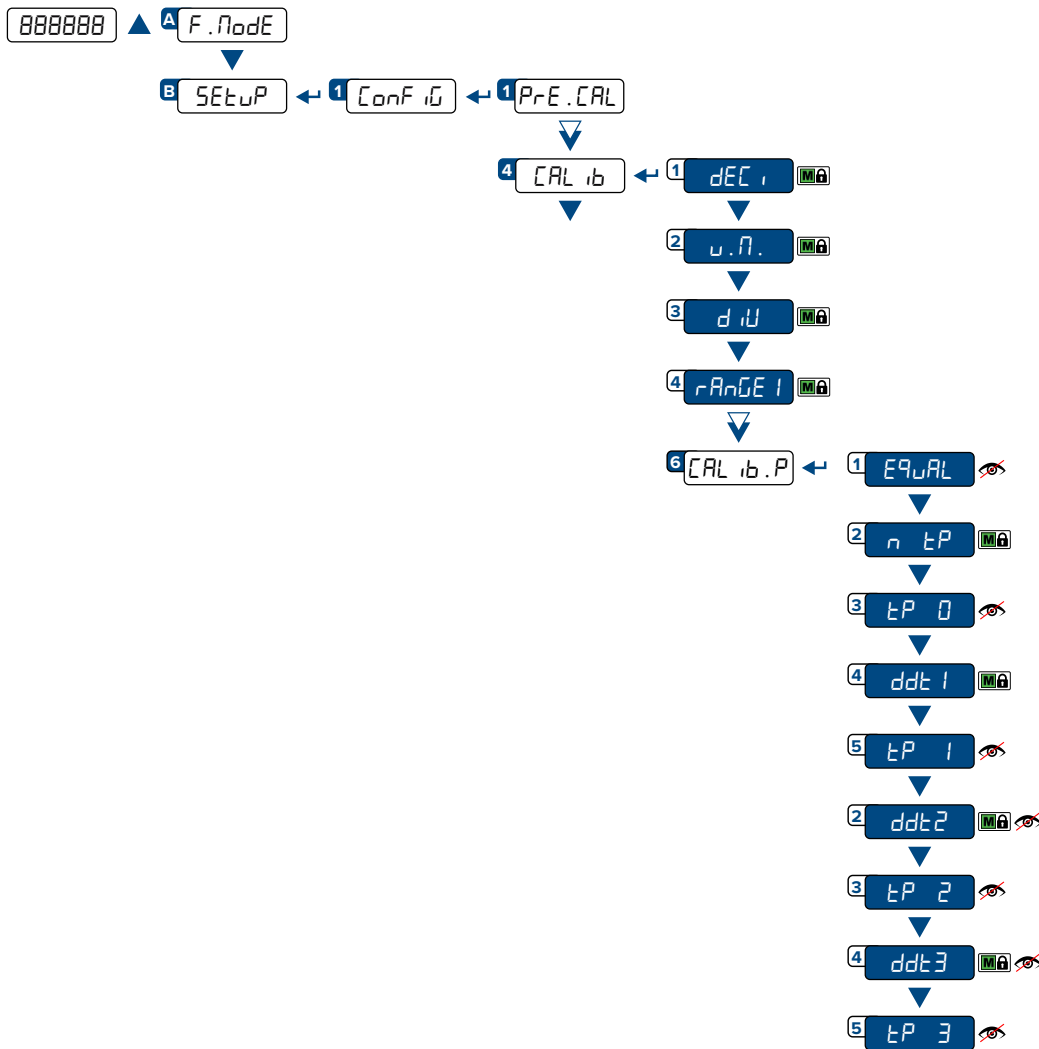

## CALIBRATION PROCEDURE:

### 1. Set the calibration parameters:

- dEC i = Number of decimals.
- u.N. = Unit of measurement (g, g, t, Lb).
- d iv = Minimum division.
- rAnGE I = Maximum range.

### 2. Acquire the calibration points *(continued on next page)*



Complete menu  
on pages 21 - 22

#### MENU ACCESS:

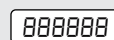

Press the ▲ key during the start-up procedure.

#### SAVING THE PARAMETERS:

Press the C key several times, until the display shows SEtUP. Press the ← key to confirm.



3. Acquire the calibration points:

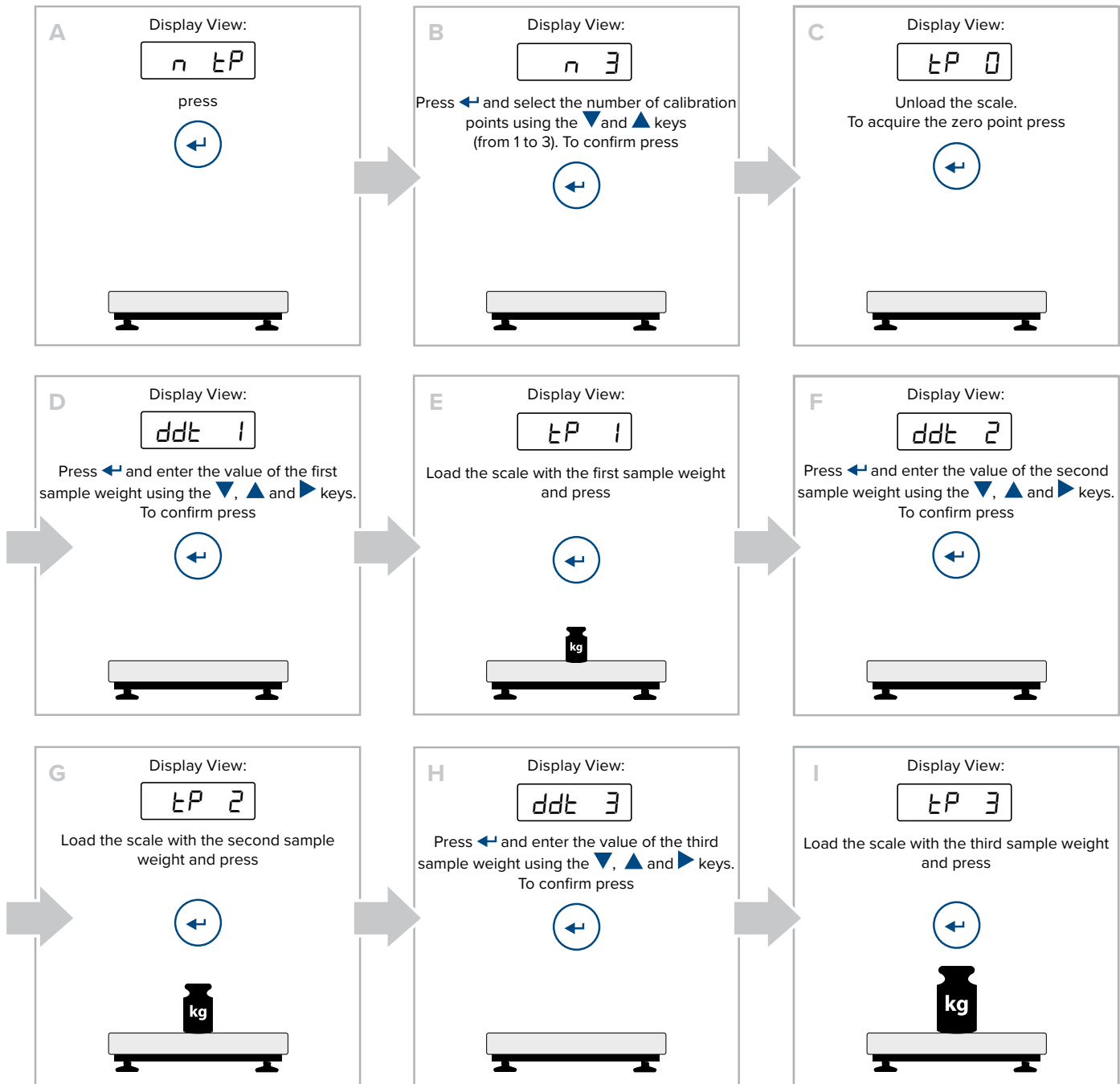

For successful calibration, the value of the largest sample weight must be at least 50% of the capacity.

LEGEND:



Indicates repeated pressing of the key.



Parameter visible only under certain conditions.



Parameter or menu subject to approval.



Default value of the parameter.

# Manual Calibration

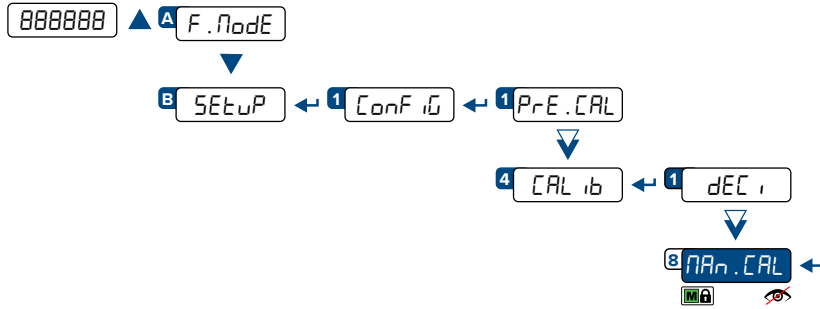

If you know the number of ADC converter points for a known weight (for example if you want to copy the calibration from one transmitter to another) the calibration points can be entered manually:

1. The display shows  $n_{od} . PnE$ , and then the last calibration point.
2. Using the ▲ and ▼ keys, select the calibration point you want to enter / change (from 0 to 9). Press the ← key to confirm.
3. The display shows  $WE iGht$ , use the ▲, ▼ and ▶ keys to enter the weight value. Press the ← key to confirm.
4. The display shows  $P_{oint5}$ , use the ▲, ▼ and ▶ keys to enter the converter points value. Press the ← key to confirm.

**i** Repeat procedure for each calibratin point.

## Quick Zero Calibration (Pre-tare Reset)

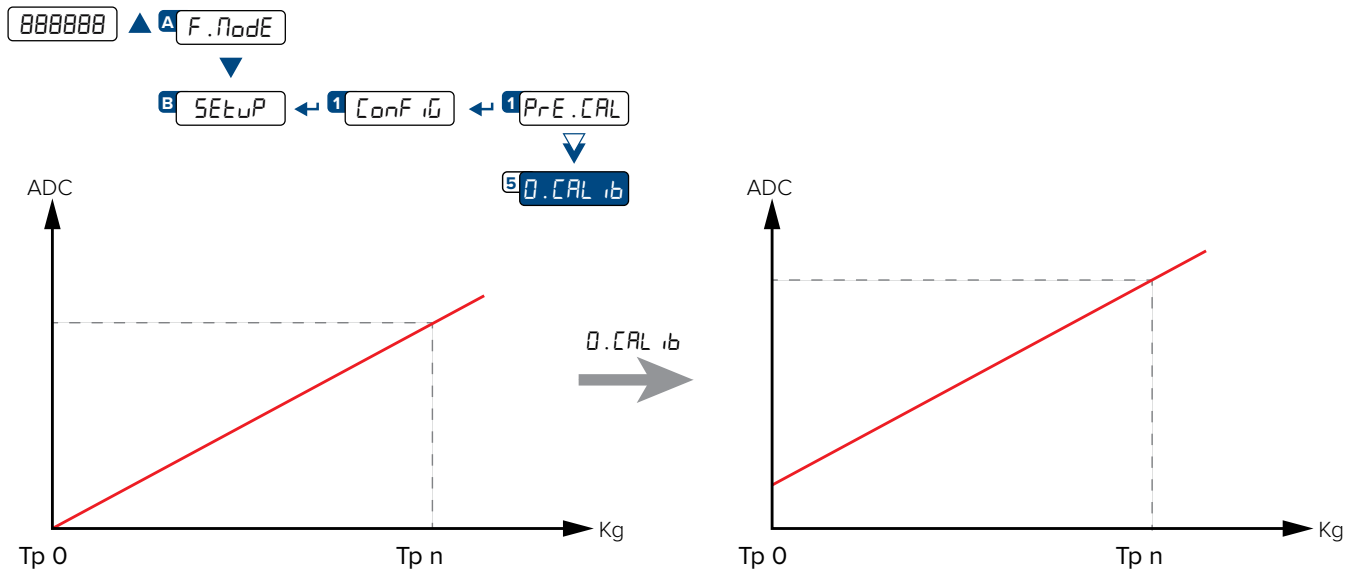

Complete menu on pages 21 - 22

**MENU ACCESS:**

888888 ▲ Press the ▲ key during the start-up procedure.

**SAVING THE PARAMETERS:**

Press the C key several times, until the display shows **SAUEP**. Press the ← key to confirm.

# ADC Converter Precalibration

888888 ▲ A F.NoDE

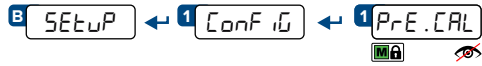



For manufacturer use only

## Filter and Stability

### Filter adjustment

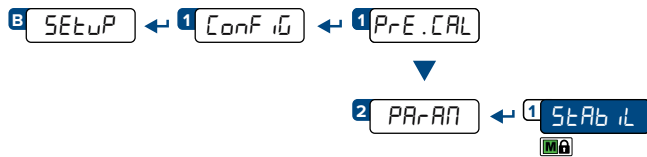
888888 ▲ A F.NoDE





Filter	Updating frequency (Hz)	Response time (ms)	Use
F 1	5	5000	High resolution or loads
F 2	10	2500	
 F 3	20	1000	Simple weighing
F 4	40	450	Dosing
F 5	80	300	
F 6	160	150	
F 7	325	50	High-speed weight transmission
F 8	650	35	
F 9	1300	20	
F 10	2600	10	
F 11	4800	5	

**i** In the case of an approved transmitter, it is possible to select only filter F 3.  
The filter affects the speed of the PC port only if ALL .PARH mode has been selected.

**LEGEND:**

 Indicates repeated pressing of the ▼ key.

 Parameter visible only under certain conditions.

 Parameter or menu subject to approval.

 Default value of the parameter.

## Anti-peak Filter

The transmitter has an additional filter for the elimination of sudden weight peaks (e.g. shocks or falling material).

The following parameters, opportunely configured, allow you to eliminate the peak by blocking the weight for its entire duration.

The weight is blocked if it remains within the number of divisions set in  $PF.LF.dU$  for the time set in  $PF.LF.tN$  and is subsequently unblocked if the weight deviates from the blocking value for a number of divisions greater than  $PF.dU$  (or  $PF.bn.dU$ ) or if the time set in  $PF.t.nE$  has elapsed.

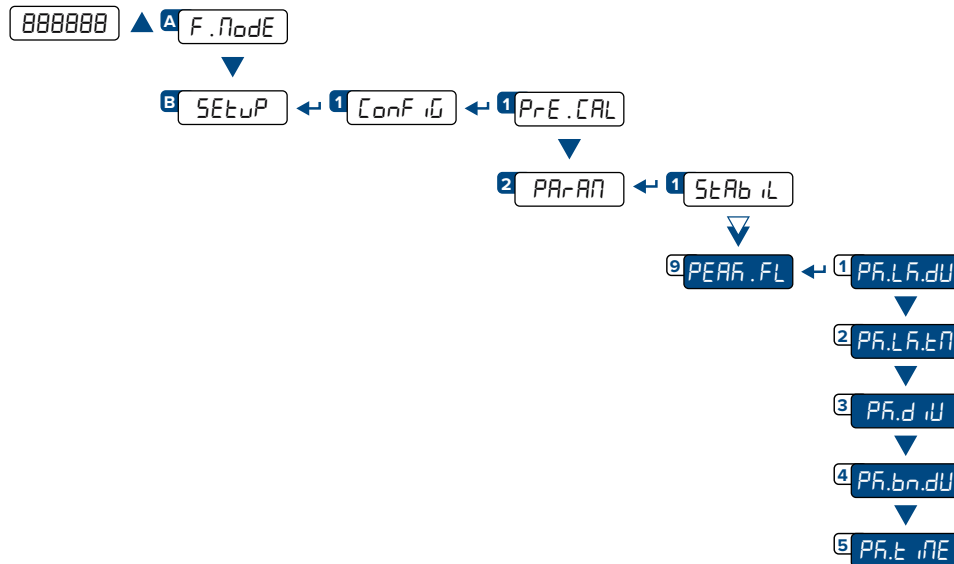

## Stability Detection Divisions

It is possible to decide that tare and zero functions (from keypad or serial command / PLC) are performed only if the weight is stable.

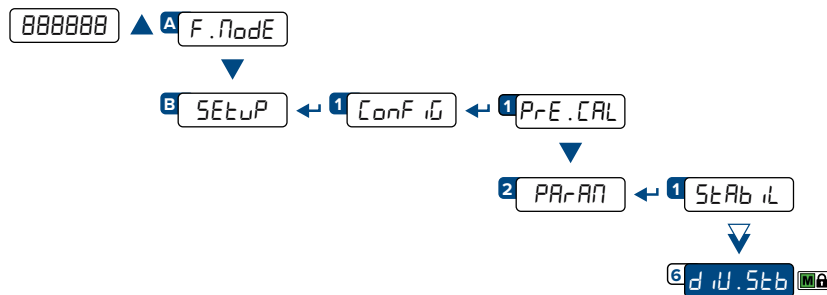

The value 0 disables the stability control.

By entering a value other than 0, you enable stability control.

Enter the number of deviation divisions beyond which the transmitter detects instability.

From 0 to 99.

= 02.

= 02.



Complete menu  
on pages 21 - 22

### MENU ACCESS:

888888 ▲

Press the ▲ key during the start-up procedure.

### SAVING THE PARAMETERS:

Press the key several times, until the display shows **SAUEP**. Press the key to confirm.

## Stability Detection Time

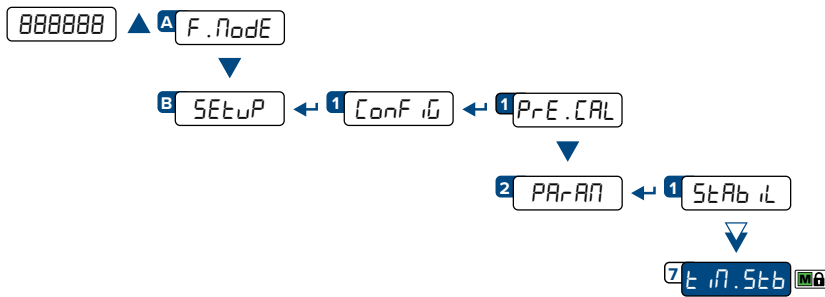

If the weight remains within the number of divisions set in *d .Stb* for the time set in this parameter, the weight is stable.

Enter the value in ms. In case of a restricted transmitter, the value is fixed at 500 ms.

from 10 to 10000.

500.

⚙️ = 500.



## Additional Filter for Stability Detection

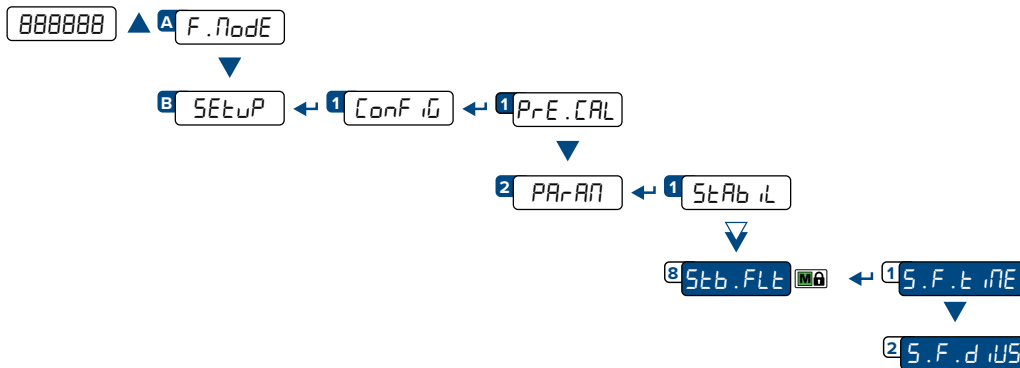

from 0 to 2000.

0.

⚙️ = 0.

from 0 to 100.

0.

⚙️ = 0.



Additional filter that locks the weight if it oscillates around a value for a maximum of 10 divisions. The weight is unlocked if the value increases/decreases for the number of divisions set in the parameter *S .t .d .iUS* for a time value greater than the time set in the parameter *S .t .t .nE*.

The value 0 disables the filter.

### LEGEND:



Indicates repeated pressing of the key.



Parameter visible only under certain conditions.



Parameter or menu subject to approval.



Default value of the parameter.

# Gravity

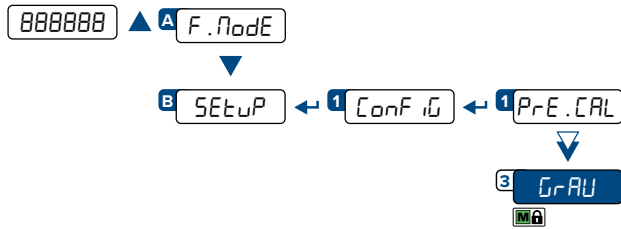

From 9.75001 to 9.84999.  
 = 9.80543.

This parameter allows you to correct the gravity acceleration value.  
 Before calibration, set the value of the calibration zone.  
 Next, set this value to the value of the zone of use.  
 Any difference between the two values will be automatically compensated.

**i** In the case of legal for trade transmitters, the value is read-only.

## EXAMPLE:



Calibration zone  
 Italy  
 $g = 9.80543$



Zone of use  
 Wisconsin  
 $g = 9.80549$

1. Before calibration, in the *GrAU* parameter enter the value 9.80543.
2. Calibrate the transmitter.
3. Before using the transmitter, in the *GrAU* parameter enter the value 9.80549.



Complete menu  
 on pages 21 - 22

### MENU ACCESS:

**888888**



Press the key during the start-up procedure.

### SAVING THE PARAMETERS:

Press the **C** key several times, until the display shows *SEtUP*. Press the **←** key to confirm.

# Reset Functions and Parameters

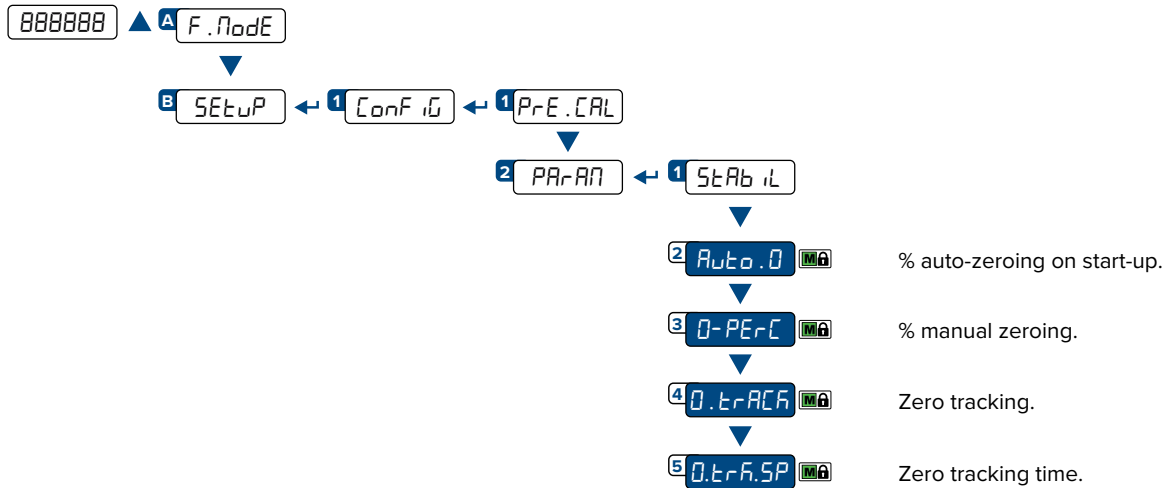

## Auto-zeroing on Start-up

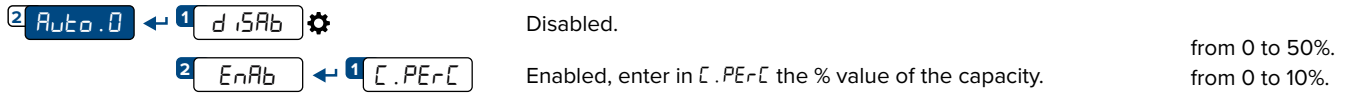

## Maximum Percentage of Manual Zeroing

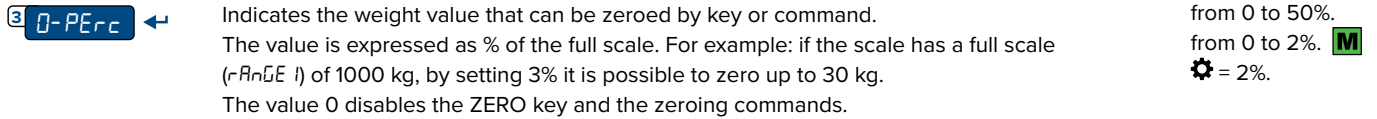

**LEGEND:**



Indicates repeated pressing of the key.



Parameter visible only under certain conditions.



Parameter or menu subject to approval.



Default value of the parameter.

## Zero Tracking

This menu allows to set zero tracking, i.e. the compensation parameter of the thermal drift of the scale; the set value corresponds to the number of divisions that is reset to zero in the fixed time of 1 second.

<b>4</b>	<b>0.trACK</b> ←	<b>1</b>	tr 10	10 divisions.
		<b>2</b>	tr 8	8 divisions.
		<b>3</b>	tr 6	6 divisions.
		<b>4</b>	tr 4	4 divisions.
		<b>5</b>	tr 2	2 divisions.
		<b>6</b>	tr 1	1 division.
	<b>M</b>	<b>7</b>	tr 1/2	1/2 division.
	<b>M</b>	<b>8</b>	tr 1/4	1/4 division.
	<b>M</b>	<b>9</b>	tr no	Tracking disabled.

## Zero Tracking Time

<b>5</b>	<b>0.trF.SP</b> ←	Once stability is reached, the transmitter waits for the time set in this parameter before bringing the weight back to zero (if it is within the divisions set in <b>0.trACK</b> ).	from 100 to 5000. 1000. <b>M</b> = 1000.
----------	-------------------	---	--

## Restoring Zero

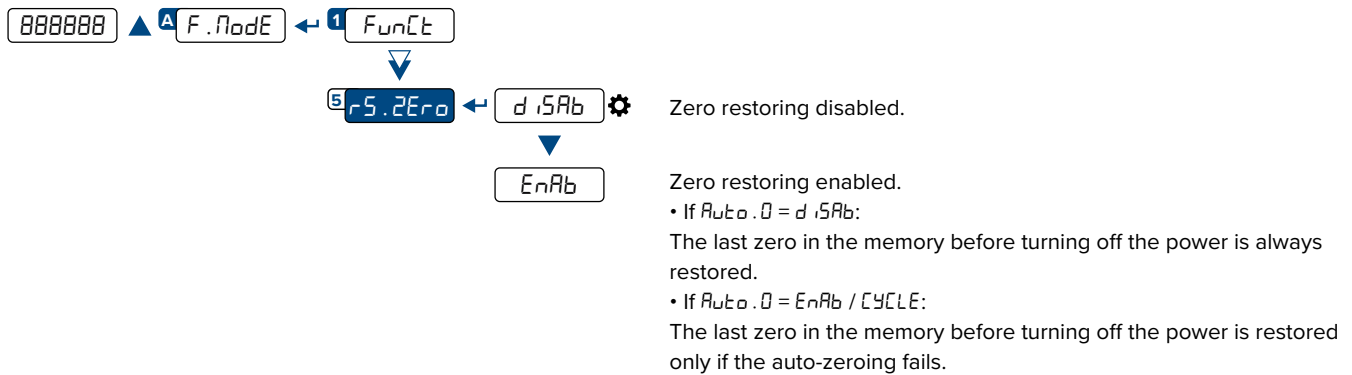

## Semi-automatic Zeroing

By pressing the ▼ key, or sending the zero command, the transmitter zeroes the gross weight on the scale. For a moment the display shows "zEr0" and then it shows 0 (gross weight).

The semi-automatic zeroing cannot be performed if:

- The weight on the scale is greater than the zero capacity (**0.PErC**).
- The weight is unstable.



Complete menu  
on pages 21 - 22

### MENU ACCESS:

**888888** ▲

Press the ▲ key during the start-up procedure.

### SAVING THE PARAMETERS:

Press the **C** key several times, until the display shows **5AUEP**. Press the ← key to confirm.



# Tare Functions and Parameters

## Tare Mode

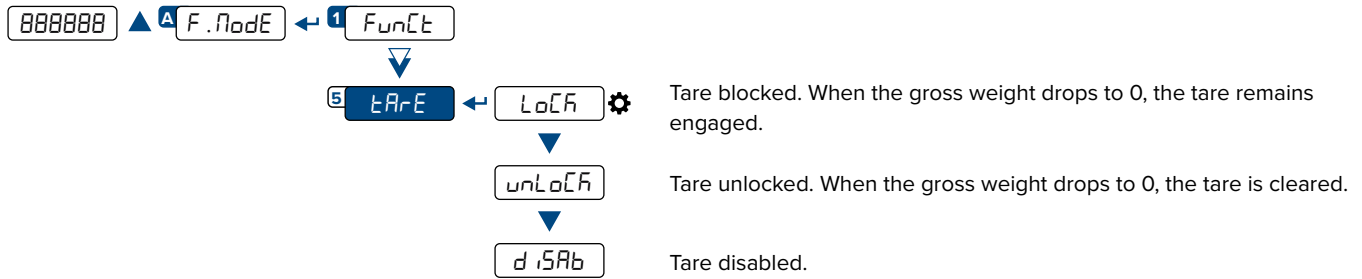

## Semi-automatic tare

By pressing the ▲ key, or sending the tare command, the transmitter sets as tare the weight on the scale. For a moment the display shows “TArE” and then it shows 0 (net weight). The 3 light indicates that the net weight is shown on the display.

The semi-automatic tare cannot be performed if:

- The weight is less than one division.
- The weight is overloaded.

## Predetermined Tare

By holding down the ▲ key, or by means of the predetermined tare command, it is possible to enter a tare value manually. For a moment the display shows “-tN-” and shows the tare present (or 0 if no tare is present). Enter the tare value and press ← to confirm.

## Clearing the Tare

The tare can be cleared in different ways:

- By unloading the scale and performing a semi-automatic tare.
- By entering a predetermined tare value of 0.
- If the weight is negative, pressing the ▼ key.

## Restoring the Tare

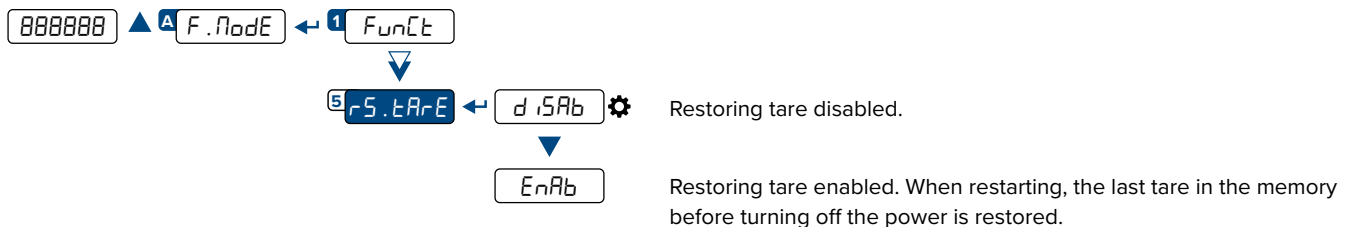

### LEGEND:



Indicates repeated pressing of the ▼ key.



Parameter visible only under certain conditions.



Parameter or menu subject to approval.



Default value of the parameter.

The alibi memory allows you to store the weight values transmitted to the computer for further processing and/or data integration. The stored values can then be retrieved from the PC port or directly on the display of the transmitter for later checking.

## Enabling the Alibi Memory

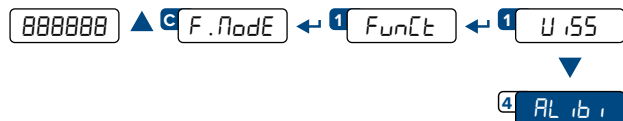

## Saving a Weighing Operation in the Alibi Memory

A weighing operation is stored after receiving the **PID** serial command (see “Serial commands” page 44) or after pressing the **←** key. The transmitter transmits on the PC port the gross weight, the tare and an ID code that uniquely identifies the weighing. The ID has the following format:

- rewrite number: 5-digit number (from 00000 to 00255) indicating the number of complete rewrites;
- weighing number: 6-digit number (from 000000 to 131072) indicating the weighing number in the current rewrite.

Each time it is saved, the weighing number is increased by 1; when it reaches the value 131072, it starts again from 000000 and the rewrite number is increased by 1.

### Example

If the weighing that has been saved is as follows:

**PIDST,1, 1.000lb, 1.000lb,00126-131072**

The next one will be:

**PIDST,1, 1.000lb, 1.000lb,00127-000000**

A weighing operation can only be saved if the weight  $\geq 0$ , stable and valid (not underloaded or overloaded).

To store the weighing operation by key, the function must be active.

In addition, if the transmitter is restricted, the weight must exceed 20 divisions.

If these conditions are not met:

- the response to the PID command will have “NO” instead of the ID (**PIDST,1, 1.000lb, 1.000lb,NO**);
- there is no transmission when the **←** key is pressed.



Complete menu  
on pages 21 - 22

#### MENU ACCESS:

888888 ▲

Press the **▲** key during the start-up procedure.

#### SAVING THE PARAMETERS:

Press the **C** key several times, until the display shows **SAVEP**. Press the **←** key to confirm.

# Reading the Alibi Memory

## FROM THE TRANSMITTER (MANUAL)

By pressing the **▶** key you can read a saved weight:

you will be asked to enter the rewrite number “r-Ed. id” (from 0 to 255) and the ID number “id” (from 0 to 131072).

The weighing data are shown. Use the **▼** and **▲** keys to scroll through the following information:

- “Ch. X”, where X indicates the scale number.
- “UN YY”, where YY indicates the unit of measurement (FG, G, t or Lb).
- “Gross”, followed by the gross weight.
- “TARE / TAREPT”, followed by the tare value.

Press the **C** key to return to weighing.

The weighing of an ID can only be verified if:

- it has a rewrite number equal to the current alibi memory number and a weighing number ≤ the last value received with the PID command;
- it has a rewrite number ≥ 0, but 1 less than the current alibi memory value, and a weighing number greater than the last value received with the PID command.

## FROM PC

To read a weighing operation from a PC, see the serial command “READING A WEIGHING OPERATION IN THE ALIBI MEMORY” on page 46.

## FROM PLC

To read a weighing operation from a PLC, refer to the Modbus and Fieldbus protocol manuals.

**i** If the alibi memory is empty, when the **▶** key is pressed the display shows “EMPTY” for one second and returns to weighing mode. If an invalid ID is entered, the display shows “no id” and returns to weighing mode.

# Initializing the Alibi Memory

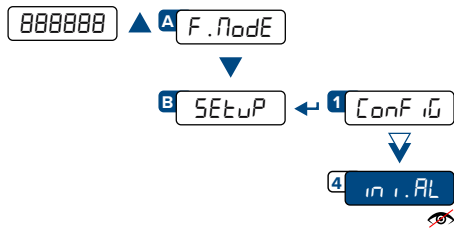

Not visible if the transmitter is legal for trade.

**i** This operation deletes all saved weighing operations; it is not possible to delete a weighing operation individually.

**LEGEND:**

- Indicates repeated pressing of the **▼** key.
- Parameter visible only under certain conditions.
- Parameter or menu subject to approval.
- Default value of the parameter.

# Use Functions

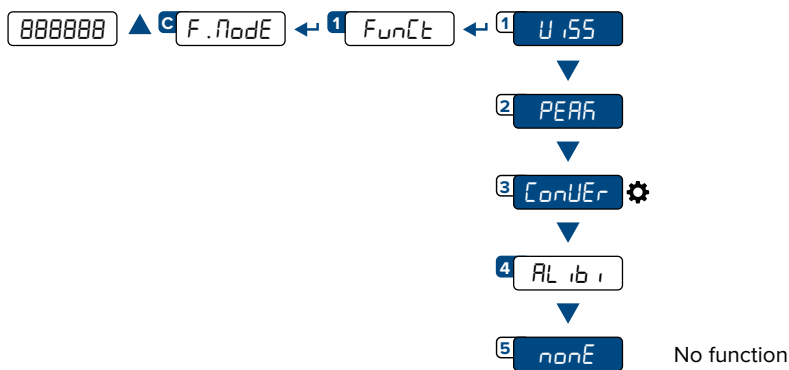

## High Resolution

**U.S.S.** Weight display in high resolution (x10). Press the **▶** key to activate or deactivate the function. When the weight is displayed in high resolution, the **4** light is lit. In the case of a restricted transmitter, the high-resolution weight display is automatically deactivated after 5 seconds.

## Peak Detection

**PEAK** Detection of the maximum weight value during a time interval. Press the **▶** key to activate the function. The display shows “-PEAK-” every 5 sec and the transmitter shows the maximum weight reached since the function was activated. To deactivate the function press the **▶** again, the display shows “PEAKoF” for a moment and shows the instantaneous weight again.

## Converting Units of Measure

**CONVEr** Converting the scale unit of measurement using a free conversion factor. Press the **▶** key to convert the weight to the next available unit. By holding down the **▶** key, you can enter a free conversion factor, which will be multiplied by the weight. **Example:** to show the cubic meters of water on the scale, enter the value 997 as the conversion factor. The **▶** key can be used to switch from the main unit of measurement to the secondary unit at any time. When the secondary unit of measurement is displayed, the **4** light is lit.

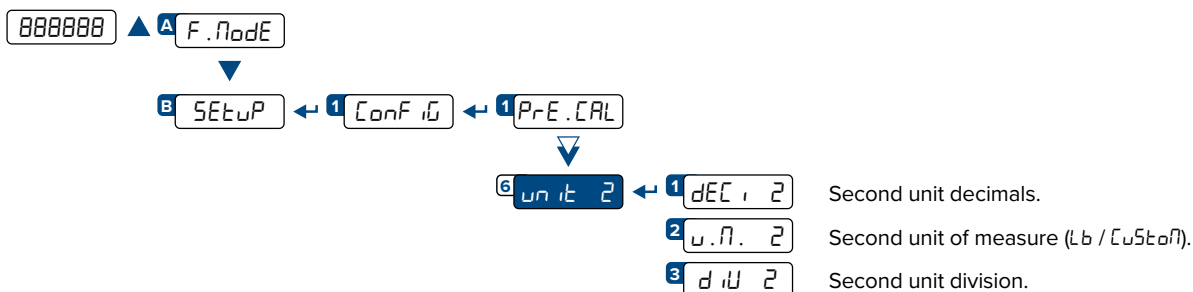

## Alibi Memory

**ALibi** (See section “Alibi memory” page 34).



Complete menu on pages 21 - 22

### MENU ACCESS:

**8888888** **▲** Press the **▲** key during the start-up procedure.

### SAVING THE PARAMETERS:

Press the **◀** key several times, until the display shows **SAVEP**. Press the **◀** key to confirm.

# Input Configuration

The indicator has two configurable inputs (bidirectional optocouplers).

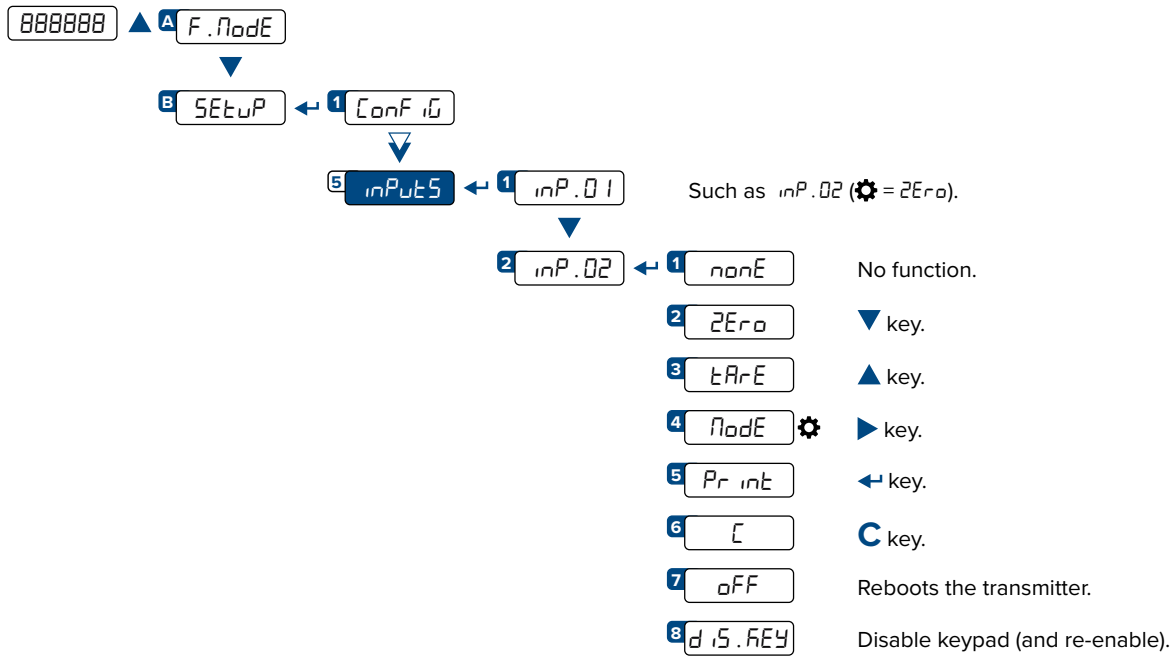

## INPUT CONNECTION:

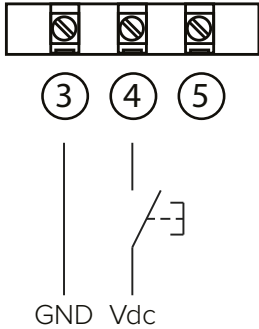

**i** The input is activated when there is a potential difference between terminals 4 - 5 (IN1 and IN2) and terminal 3 (INCOM). The inputs are bidirectional, therefore it is possible to invert GND and Vdc.

### LEGEND:



Indicates repeated pressing of the key.



Parameter visible only under certain conditions.



Parameter or menu subject to approval.



Default value of the parameter.

# Output Configuration

The indicator has two programmable outputs (photomosfet).

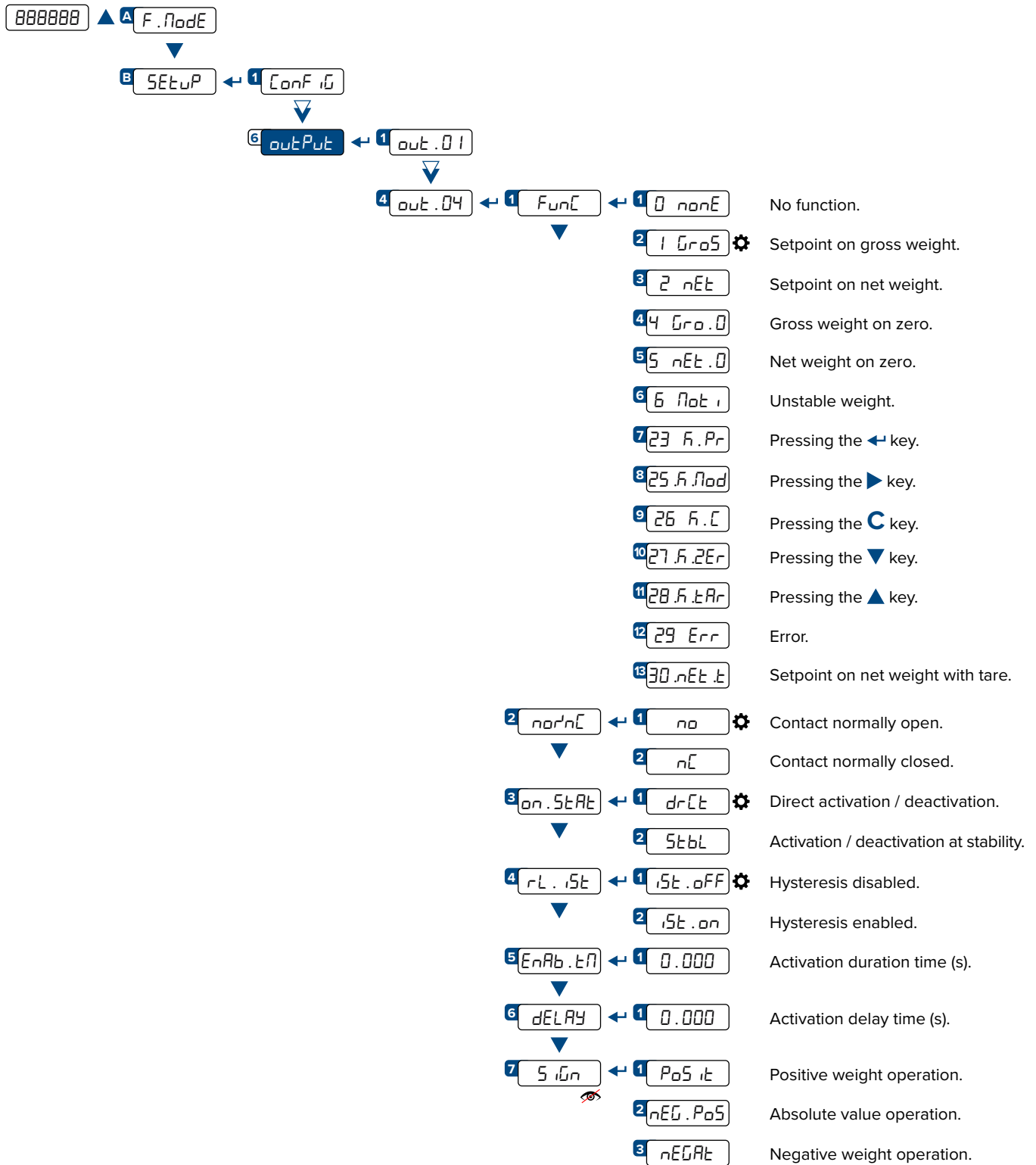

Complete menu  
on pages 21 - 22

#### MENU ACCESS:

888888 ▲

Press the ▲ key during the start-up procedure.

#### SAVING THE PARAMETERS:

Press the C key several times, until the display shows 5AUEP. Press the ← key to confirm.

# Analog Output Configuration

The SCT-1SX-AN model has an analog output in voltage (0 - 5 / 0 - 10 Vdc) or current (4 - 20 / 0 - 20 mA).

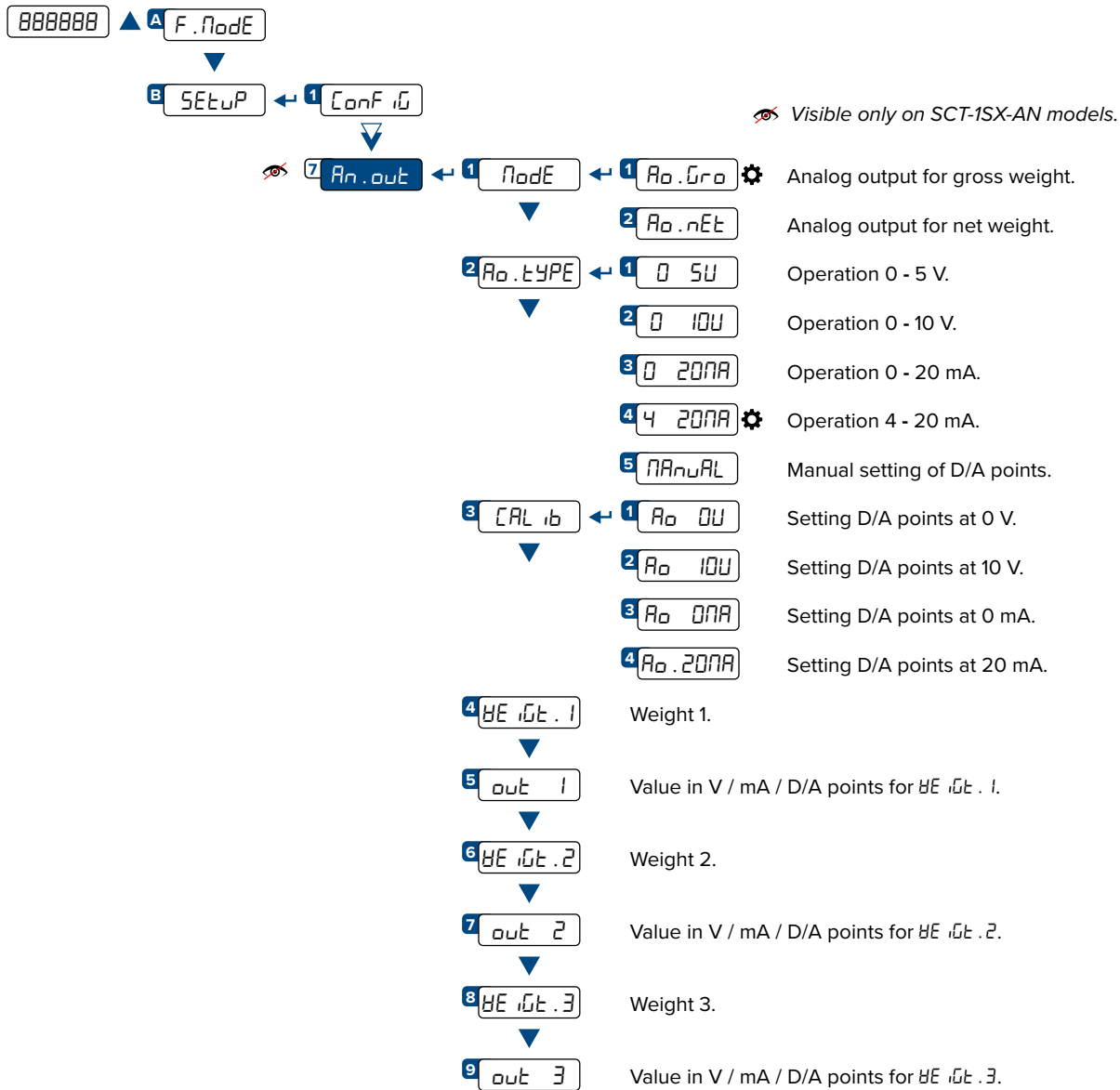

**i** This menu allows an advanced configuration of the analog output.  
For simple configurations, use the quick menu (Refer to **Quick Start Guide**).

**LEGEND:**

- Indicates repeated pressing of the key.
- Parameter visible only under certain conditions.
- Parameter or menu subject to approval.
- Default value of the parameter.

**CALIBRATION PROCEDURE:**

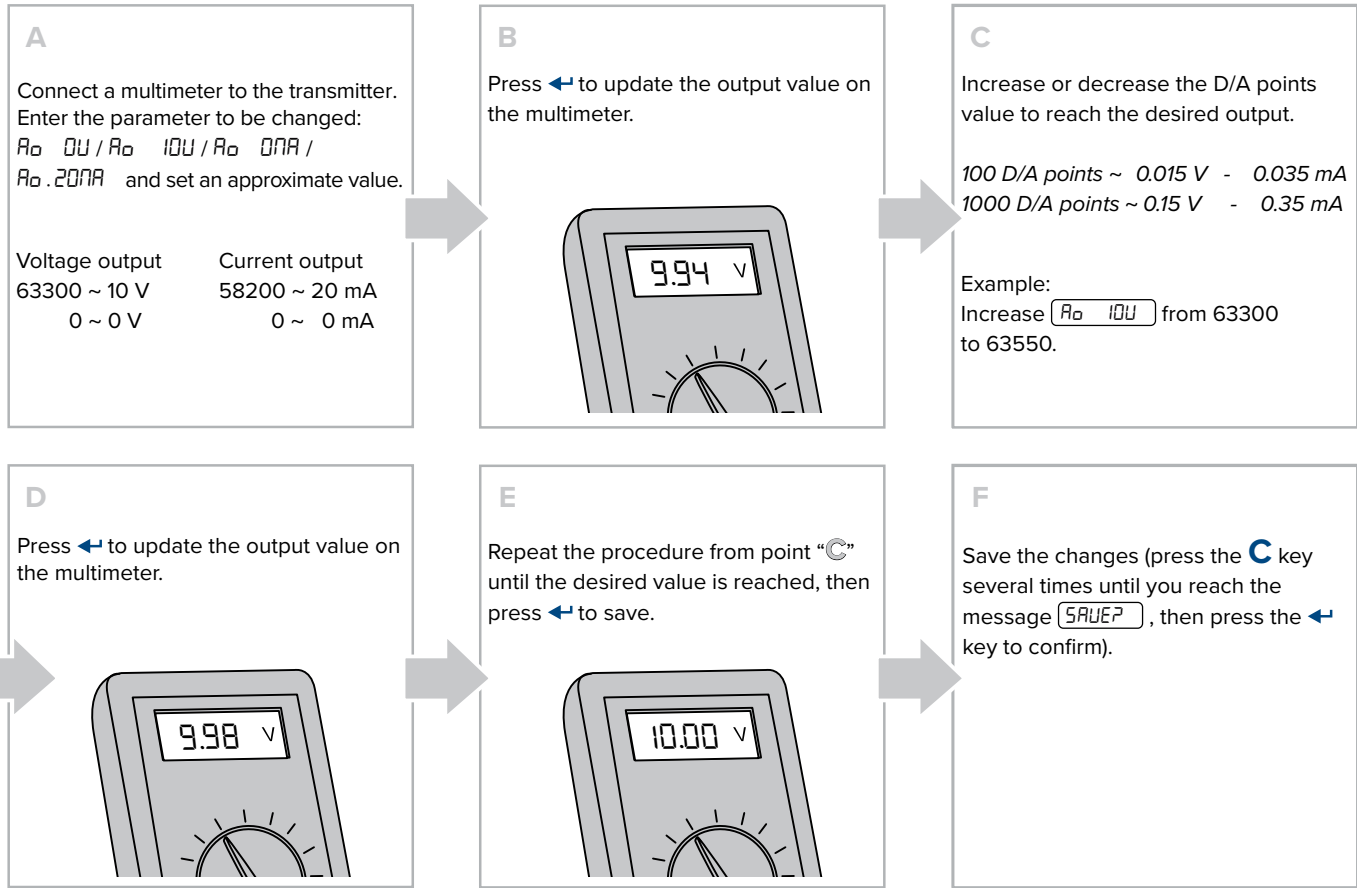

**ANALOG OUTPUT GRAPHS:**

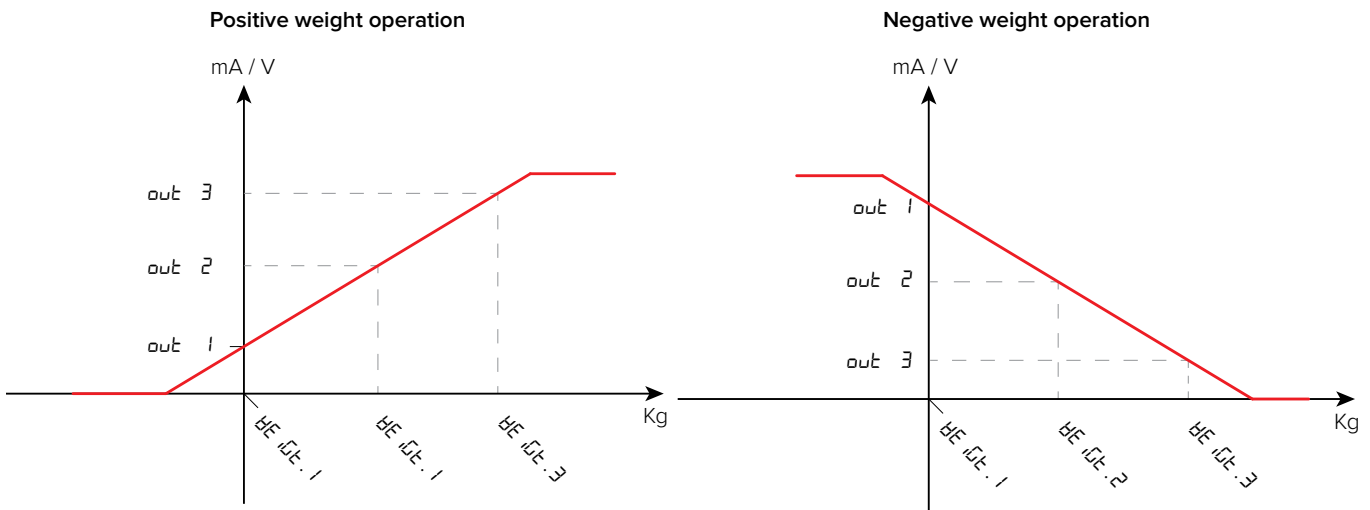

**i** Voltage or current operation is determined by the connection to the transmitter terminals:

Current: 9 (+) and 10 (-).  
Voltage: 11 (+) and 12 (-).

**MENU ACCESS:** ▲ Press the ▲ key during the start-up procedure.

**SAVING THE PARAMETERS:** Press the C key several times, until the display shows SAVEP. Press the ← key to confirm.



# Serial Communication Configuration

All models are equipped with a micro-USB port that is always accessible for transmitter configuration and diagnostics. The SCT-1SX and SCT-1SX-AN models also have an RS485 port.

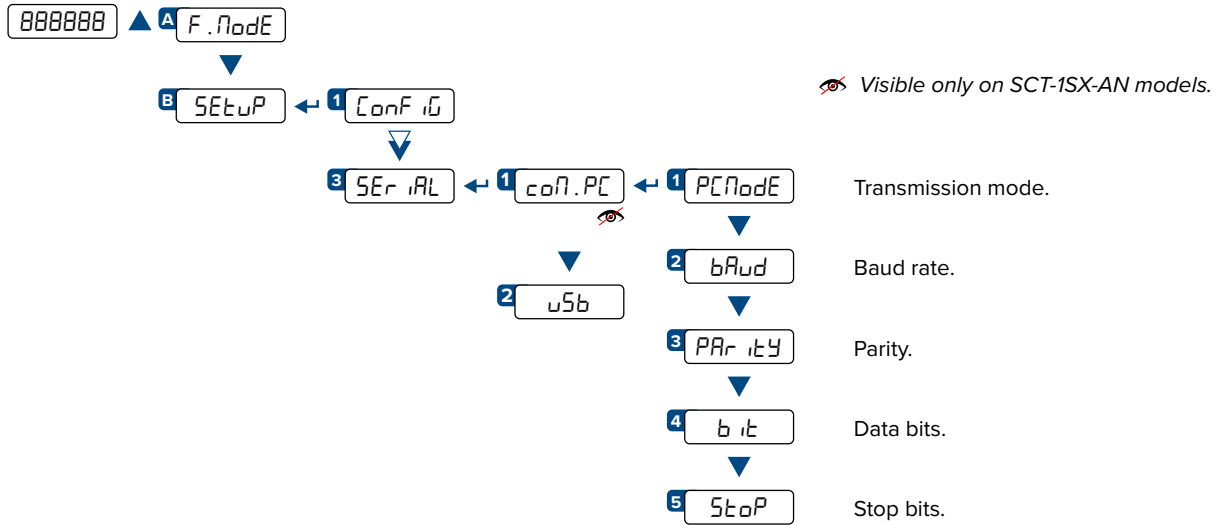

## USB port Configuration

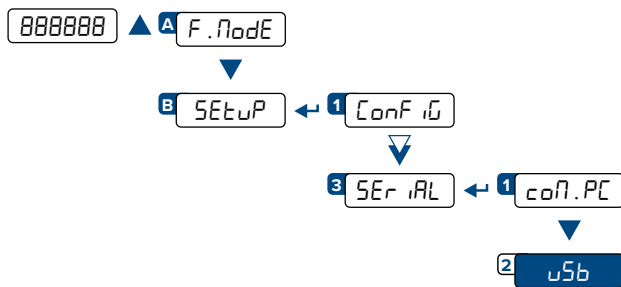

Useful for the configuration of the instrument from PC with Rice Lake Tools.

**LEGEND:**



Indicates repeated pressing of the key.



Parameter visible only under certain conditions.



Parameter or menu subject to approval.



Default value of the parameter.

## Transmission Mode

- 1 **PCNode** ← 1 ondE Transmission on demand.
- 2 rEPE.6 Transmission of a 6-digit weight.
- \* 3 Pr in .St Standard string transmission when the ← key is pressed.
- \* 4 Pr in .EH Extended string transmission when the ← key is pressed.
- 5 485 Transmission with 485 protocol (enter the 485 address of the transmitter).
- 6 Modbus ⚙️ Transmission with Modbus protocol (refer to the Modbus protocol manual).
- 7 ALL .NAH Continuous high speed weight transmission for conversion applications (single channel only, 1600 hz).
- \* 8 ALL .Std Continuous transmission of the standard string (select the transmission frequency, about 1 to 80 Hz).
- \* 9 ALL .EH Extended string transmission of the extended string (select the transmission frequency, about 1 to 80 Hz).
- \* 10 StAb .St Stable transmission of the standard string.
- \* 11 StAb .EH Stable transmission of the extended string.

\* When selecting one of these protocols, you are asked if you want to display the 485 address at the beginning of the string: dEU . id ← YES / no.

## Baud Rate, Parity, Data Bits, Stop Bits

- 2 **bAud** ← 1 9600 ⚙️
  - 2 4800
  - 3 2400
  - 4 1200
  - 5 115200
  - 6 57600
  - 7 38400
  - 8 19200
- 3 **PAR ity** ← 1 nonE ⚙️ No parity, 8 data bits, 1 stop bit.
  - 2 EVEN Even.
  - 3 odd Odd.
- 4 **bit** ← 1 8 ⚙️ 8 bits.
  - 2 7 7 bits.
- 5 **StoP** ← 1 1 ⚙️ 1 stop bit.
  - 2 2 2 stop bits.

Complete menu on pages 21 - 22

**MENU ACCESS:**

888888 ▲ Press the ▲ key during the start-up procedure.

**SAVING THE PARAMETERS:**

Press the **C** key several times, until the display shows **SAVEP**. Press the ← key to confirm.

## Standard String

[01]ST,GS, 0.0,kg<CR><LF>

Where:

01	Transmitter code 485 (2 characters), only if communication mode 485 is enabled
ST	Scale status (2 characters): <u>US</u> - Unstable weight <u>ST</u> - Stable weight <u>OL</u> - Weight overload (out of range) <u>UL</u> - Weight underload (out of range)
,	Character ASCII 044
GS	Type of weight data (2 characters) <u>GS</u> - Gross <u>NT</u> - Net <u>VL</u> - Microvolts <u>RZ</u> - Converter points
,	Character ASCII 044
0.0	Weight (8 characters including the decimal point)
,	Character ASCII 044
kg	Unit of measurement (2 characters)
<CR><LF>	Transmission terminator, characters ASCII 013 and ASCII 010

## Extended String

[01]1ST,1, 0.0,PT 20.8, 0,kg,01/02/19 11:12:13<CR><LF>

Where:

01	Transmitter code 485 (2 characters), only if communication mode 485 is enabled
1	Number of the active scale
ST	Scale status (2 characters): <u>US</u> - Unstable weight <u>ST</u> - Stable weight <u>OL</u> - Weight overload (out of range) <u>UL</u> - Weight underload (out of range)
,	Character ASCII 044
0.0	Weight (8 characters including the decimal point)
,	Character ASCII 044
PT	Preset tare indication
20.8	Tare (8 characters including the decimal point)
,	Character ASCII 044
0	Character ASCII 048
,	Character ASCII 044
kg	Unit of measurement (2 characters)
,	Character ASCII 044
01/02/19 11:12:13	dd/mm/yy hh:mm:ss (only with REXD command and optional clock card)
<CR><LF>	Transmission terminator, characters ASCII 013 and ASCII 010

# Serial Commands

By selecting the PC port on demand mode (*andE*), you can communicate with the transmitter via serial commands. For each command received, the transmitter emits a string containing the response (refer to the command description) or one of the following signals:

OK<CRLF>	Command sent when sending a correct command. This response does not imply that the command is executed.
ERR01<CRLF>	Command sent correctly but followed by letters entered unintentionally (e.g. READF, TARES).
ERR02<CRLF>	Incorrect command data.
ERR03<CRLF>	Command sent not allowed (transmitter busy, or not used in the selected operating mode).
ERR04<CRLF>	Command sent non-existent.

**i** If the 485 protocol has been selected, you must precede the command with the transmitter address (e.g. 01READ).

## WEIGHT READING (standard string)

Format	R   E   A   D   <CRLF>
Response	Standard string<CR LF>.

## EXTENDED WEIGHT READING

Format	R   E   X   T   <CRLF>
Response	Extended string<CR LF>.

## WEIGHT READING IN HIGH RESOLUTION (X10)

Format	G   R   1   0   <CRLF>
Response	Standard string with weight in resolution x10 <CRLF>.

## AUTOMATIC TARE

Format	T   A   R   E   [I]   <CRLF>
Response	OK<CR LF> (or ERRxx).

Send the TAREI command to perform tare without stability control.

## MANUAL TARE

Format	T   M   A   N   t   t   t   t   t   t   <CRLF>
Where	ttttt tare value
Response	OK<CR LF> (or ERRxx).

By entering a manual tare value of 0, the tare on the scale is cleared.

## ZEROING

Format	Z   E   R   O   [I]   <CRLF>
Response	OK<CR LF> (or ERRxx).

Send the ZEROI command to perform zeroing without stability control.

## DISABLING KEYPAD

Format	K   E   Y   E   D   <CRLF>
Response	OK<CR LF> (or ERRxx).

## ENABLING KEYPAD

Format	K   E   Y   E   E   <CRLF>
Response	OK<CR LF> (or ERRxx).

## READING INPUTS

Format	I   N   P   U   n   <CRLF>
Where	n Input (1 / 2).
Response	I   N   P   U   n   v   v   v   v   <CRLF>
Where	n Input number. vvv Input status: 0000 = Not active. 0001 = Active. FFFF = Input reading error.

## READING OUTPUTS

Format	O   U   T   S   n   <CRLF>
Where	n Output (1 / 4).
Response	O   U   T   S   n   v   v   v   v   <CRLF>
Where	n Output number. vvv Output status: 0000 = Not active. 0001 = Active. FFFF = Output reading error.

### PRESSING A KEY

Format	K	E	Y	P	x	x	<CR LF>
Where	xx	Key code.					
	00	▼					
	01	▲					
	02	▶					
	03	←					
	04	C					

**i** To simulate pressing a key, you must send the KEYP and KEYR commands in succession. If more than 1.5 s pass after the KEYP command is sent, the transmitter will execute the function associated with prolonged pressing of the key.

Response	OK<CR LF> (or ERRxx).
----------	-----------------------

### RELEASING A KEY

Format	K	E	Y	R	<CR LF>
Response	OK<CR LF> (or ERRxx).				

### BRIDGE BETWEEN THE SERIAL PORTS

Format	B	R	I	D	G	E	1	<CR LF>
Response	OK<CR LF> (or ERRxx).							

### SCALE INFORMATION

Format	R	A	L	L	<CR LF>																		
Response	s	s	,	b	,	N	N	N	N	N	N	u	u	,	L	L	L	L	L	L	u	u	,
	Y	Y	T	T	T	T	T	T	u	u	,	S	S	S	,	A	A	A	,	C	C	C	C
	,	,	R	R	R	R	R	-	I	I	I	I	I	I	<CR LF>								
Where	ss	UL = Underload. OL = Overload. ST = Stable weight. US = Unstable weight.																					
	b	Number of the active scale.																					
	NNNNNuu	Net weight with unit of measurement.																					
	LLLLLuu	Gross weight with unit of measurement.																					
	YY	PT if a manual tare is present or " ".																					
	TTTTTu	Tare with unit of measurement.																					
	SSS	Scale status: 000 = scale weighing. 001 = entering a numerical value. 002 = scale in technical menu.																					
	AAA	Counter keys pressed: 0001 = ▼ 0002 = ▲ 0003 = ▶ 0004 = ← 0170 = C																					
	CCCC	Code of last key pressed.																					
RRRRR	Last rewrite number saved to Alibi memory.																						
IIIII	Last ID number saved to Alibi memory.																						

**READING OF MICROVOLTS**

<b>Format</b>	M	V	O	L
<b>Response</b>	Standard string<CR LF>.			

**READING OF CONVERTER POINTS**

<b>Format</b>	R	A	Z	F
<b>Response</b>	Standard string<CR LF>.			

**INITIALIZING ALIBI MEMORY**

<b>Format</b>	A	L	D	L
<b>Response</b>	ALDLOK / ALDLNO <CR LF>			

**WEIGHT READING WITH DATE AND TIME**

<b>Format</b>	R	E	X	D
<b>Response</b>	Extended string<CR LF>.			

**READING A WEIGHING OPERATION IN THE ALIBI MEMORY**

<b>Format</b>	A	L	R	D	X	X	X	X	X	-	Y	Y	Y	Y	Y	Y	<CR LF>
<b>Response</b>	b	,	L	L	L	L	L	L	L	L	L	L	u	u	,		
	Y	Y	T	T	T	T	T	T	T	T	T	T	u	u	<CR LF>		
<b>Where</b>	b	Scale number.															
	LLLLLLLLLuu	Gross weight with unit of measurement.															
	YY	"PT if a manual tare is present or " ".															
	TTTTTTTTTuu	Tare with unit of measurement.															

**SAVING A WEIGHING OPERATION IN THE ALIBI MEMORY**

<b>Format</b>	P	I	D	<CR LF>																				
<b>Response</b>	P	I	D	S	T	,	b	,	L	L	L	L	L	L	L	L	L	L	L	u	u	,	Y	Y
	T	T	T	T	T	T	T	T	T	T	u	u	,	X	X	X	X	X	-	Y	Y	Y	Y	
	Y	Y	<CR LF>																					
<b>Where</b>	b	Scale number.																						
	LLLLLLLLLuu	Gross weight with unit of measurement.																						
	YY	"PT if a manual tare is present or " ".																						
	TTTTTTTTTuu	Tare with unit of measurement.																						
	XXXXX	Rewrite number.																						
	YYYYYY	ID number.																						

 The fieldbus protocol is described in the respective manual.

# Modbus Protocol

## MODBUS REGISTERS FOR DATA READING (SINGLE SCALE)

Data	Register	DESCRIPTION	
Gross Weight	30001	Gross weight value.	
	30002		
Net Weight	30003	Net weight value.	
	30004		
Input status register	30005	Bit 15 <sub>(msb)</sub>	Active channel.
		Bit 14 <sub>(msb)</sub>	Active channel.
		Bit 13	No function.
		Bit 12	No function.
		Bit 11	No function.
		Bit 10	No function.
		Bit 9	Input no. 2 status.
		Bit 8 <sub>(lsb)</sub>	Input no. 1 status.
		Bit 7 <sub>(msb)</sub>	Gross zero zone (0 = "outside zone 0"; 1 = "in zone 0").
		Bit 6	Tare PT (1 = a preset tare is active).
		Bit 5	Tare (1 = a tare is active).
		Bit 4	Overload condition (0 = No; 1 = Overload).
		Bit 3	Underload condition (0 = No; 1 = Underload).
		Bit 2	Stability (0 = Unstable; 1 = Stable).
		Bit 1	Gross weight sign (0 = "+"; 1 = "-").
		Bit 0 <sub>(lsb)</sub>	Net weight sign (0 = "+"; 1 = "-").
Command status register	30006	Last command received.	
		Bit 7 <sub>(msb)</sub>	Last command result.
		Bit 6	Last command result.
		Bit 5	Last command result.
		Bit 4	Last command result.
		Bit 3	Processed command count.
		Bit 2	Processed command count.
		Bit 1	Processed command count.
		Bit 0 <sub>(lsb)</sub>	Processed command count.
Output status register	30007	No function.	
		Bit 7 <sub>(msb)</sub>	No function.
		...	...
		Bit 2	No function.
		Bit 1	Digital output 1 status (0 = OFF; 1 = ON).
		Bit 0 <sub>(lsb)</sub>	Digital output 2 status (0 = OFF; 1 = ON).
$\mu$ V Channel 1	30111	$\mu$ V value.	



This manual contains the main registers for reading data / sending commands.  
Refer to the Modbus protocol manual for a complete list of available registers.

## MODBUS REGISTERS FOR SENDING COMMANDS

Data	Register	DESCRIPTION																		
<i>Command</i>	40001	Main commands available:																		
		<table border="1"> <thead> <tr> <th>Value</th> <th>Command</th> </tr> </thead> <tbody> <tr> <td>00 Hex</td> <td>No command</td> </tr> <tr> <td>01 Hex</td> <td>Zero</td> </tr> <tr> <td>02 Hex</td> <td>Tare</td> </tr> <tr> <td>03 Hex</td> <td>Predetermined tare</td> </tr> <tr> <td>0A Hex</td> <td>Setting setpoint 1</td> </tr> <tr> <td>0B Hex</td> <td>Setting setpoint 2</td> </tr> <tr> <td>19 Hex</td> <td>Setting digital outputs</td> </tr> <tr> <td>22 Hex</td> <td>Rebooting the transmitter</td> </tr> </tbody> </table>	Value	Command	00 Hex	No command	01 Hex	Zero	02 Hex	Tare	03 Hex	Predetermined tare	0A Hex	Setting setpoint 1	0B Hex	Setting setpoint 2	19 Hex	Setting digital outputs	22 Hex	Rebooting the transmitter
		Value	Command																	
		00 Hex	No command																	
		01 Hex	Zero																	
		02 Hex	Tare																	
		03 Hex	Predetermined tare																	
		0A Hex	Setting setpoint 1																	
		0B Hex	Setting setpoint 2																	
		19 Hex	Setting digital outputs																	
22 Hex	Rebooting the transmitter																			
<i>Parameter 1</i>	40002	First command parameter. The parameter is always expressed as an absolute value (no decimal / sign).																		
	40003																			
<i>Parameter 2</i>	40004	Second command parameter. The parameter is always expressed as an absolute value (no decimal / sign).																		
	40005																			

### EXAMPLE 1

To reset the weight on the scale:

- Set the command in register 40001

Byte	Value
1	00 Hex
2	01 Hex

### EXAMPLE 2

To set a predetermined tare of 1000kg:

- Set the value in parameter 1 (registers 40002-40003)
- Set the command in register 40001

Byte	Value
1	00 Hex
2	03 Hex
3 <sub>(MSB)</sub>	00 Hex
4	00 Hex
5	03 Hex
6 <sub>(LSB)</sub>	E8 Hex



This manual contains the main registers for reading data / sending commands.  
Refer to the Modbus protocol manual for a complete list of available registers.



# Diagnostics

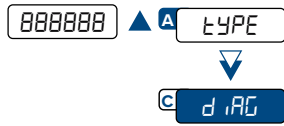

- 1 **PRG .VER** Display of firmware release (e.g. 01.06.00).
- 2 **MANUF .d** Display of firmware libraries (for use by the manufacturer).
- 3 **d iU .int** Display of calibration internal divisions.
- 4 **ADC .uV** Display of the  $\mu\text{V}$  related to the weight on the scale.

For correct operation, the value of the  $\mu\text{V}$  of each channel must be less than 30000 with a weight equal to the maximum capacity. This value must be stable, and increase if a load is applied to the cell.

- 5 **ADC .Pnt** Display of the A/D points of the converter related to the weight on the scale.

For correct operation, the value of A/D points must be stable, and increase if a load is applied to the cell.

- 6 **WE iGht** Display of the weight on the scale.

- 7 **CAL .PntS** Display of calibration points with corresponding A/D point values.

- 8 **d iSPLA** Activation of all display segments and indicators.

- 9 **KEYb** The code of last key pressed is shown on the display:

▼	8001
▲	8002
▶	8003
←	8004
C	80AA

Press the same key 3 consecutive times to exit.

- 10 **outPut** Activation of the output shown on the display (rEL . 1 / rEL . 2).  
Use the ▲ and ▼ keys to activate the two outputs.

- 11 **inPutS** Checking the status of the inputs:  
value 0 indicates that the input is disabled, value 1 indicates that the input is enabled.  
Use the ▲ and ▼ keys to display the two inputs.

## LEGEND:



Indicates repeated pressing of the ▼ key.



Parameter visible only under certain conditions.



Parameter or menu subject to approval.



Default value of the parameter.

12 An.out

Analog output test.  
Use the ▲, ▼, ► keys to enter the D/A point value of the analog output.  
Press the ◀ key to confirm and update the V / mA value of the analog output.

13 Ser.num

Display of transmitter serial number.

14 CEL.CHR

Voltage value test (used to display load cell error "CEL.Err").

## Programming the Setpoints

In weighing mode, if the output functions (1 Gross / 2 Net) have been set correctly, pressing ◀ for 3 seconds will enter the setpoint programming menu:

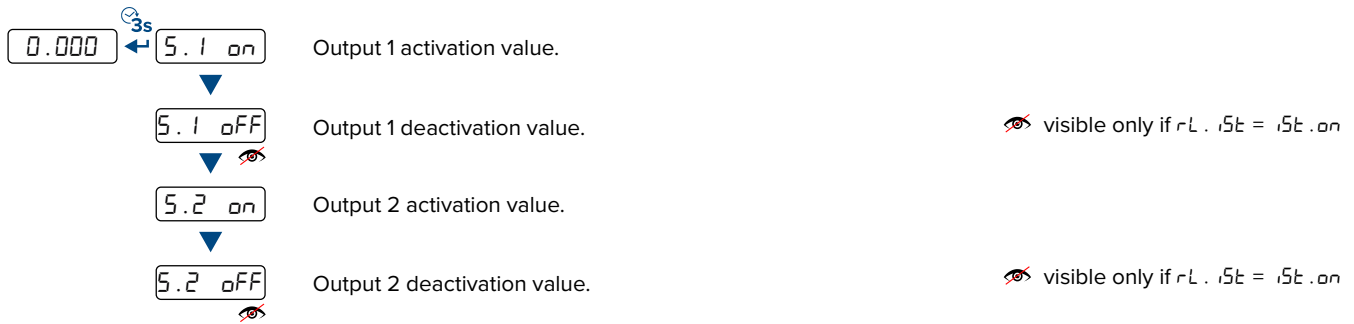

Once you have entered the desired values, press C. The display shows "StarE" and returns to weighing mode.



Complete menu  
on pages 21 - 22

### MENU ACCESS:

888888 ▲

Press the ▲ key during the start-up procedure.

### SAVING THE PARAMETERS:

Press the C key several times, until the display shows StarE. Press the ◀ key to confirm.

# Restoring Factory Settings

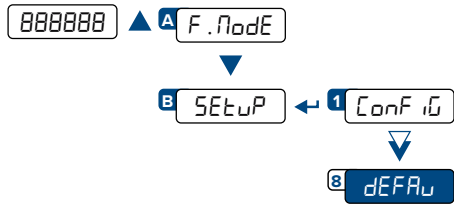

The transmitter is initialized and the default parameters (indicated by the ⚙ icon) are activated. Pressing ← the display shows “dFLt?” confirm further with ← or exit by pressing another key.

The actual activation of the default parameters is performed by saving the settings (SAUE?) while exiting the menu.

## LEGEND:



Indicates repeated pressing of the ▼ key.



Parameter visible only under certain conditions.



Parameter or menu subject to approval.



Default value of the parameter.

Alarm	Description
<i>PrEC</i>	Displayed if you try to calibrate a point without first confirming the number of calibration points ( <i>n tP</i> ).
<i>Er .Flot</i>	Calibration error: unstable weight during point acquisition.
<i>ErPnt</i>	Calibration error: during the acquisition of a calibration point a NULL value was read from the converter.
<i>Err .H. 1</i>	Error that occurs if the capacity of channel <i>H</i> is not set, or there is an error in the calibration parameters of channel <i>H</i> , where <i>H</i> indicates the number of the channel to which the error refers.
<i>oUEr H</i>	Error that occurs if the capacity of channel <i>H</i> is not set, or there is an error in the calibration parameters of channel <i>H</i> , where <i>H</i> indicates the number of the channel to which the error refers.
<i>Er 11</i>	Calibration error: a sample weight that is too low was used; it is recommended to use a weight of at least half the scale's capacity.
<i>Er 12</i>	Calibration error: The acquired calibration point ( <i>tP 1 / tP 2 / tP 3</i> ) is equal to the zero point ( <i>tP0</i> ).
<i>Er 37</i>	Scale to be calibrated (we recommend resetting the transmitter to the factory default "dEFRAu" settings before proceeding).
<i>Er 39</i>	Scale to be calibrated (we recommend resetting the transmitter to the factory default "dEFRAu" settings before proceeding).
<i>[-Er . -36</i>	Negative internal points were calculated during calibration: <ul style="list-style-type: none"> <li>the calibration point is below the zero point;</li> <li>the signal is negative (check the connections).</li> </ul>
<i>[-Er . -37</i>	Internal points below the minimum value were calculated during calibration: <ul style="list-style-type: none"> <li>the calibration point is equal to the zero point;</li> <li>too high a capacity has been set with respect to the division.</li> </ul>
<i>hd .Err</i>	Hardware error: software not compatible with the installed hardware.
<i>AL .Err</i>	Displayed when the alibi memory is enabled and the transmitter does not detect the presence of the card when the power is turned on. The <i>ConU</i> function is set automatically, but not saved in the setup environment.
<i>bUSy</i>	Printing in progress (printer serial port busy) or transmitter waiting to transmit a print to PC.
<i>unStAb</i>	You are trying to print with an unstable weight.
<i>un .oUEr</i>	You are trying to print with the weight in underload / overload.
-----	The weight is overloaded (9 divisions over the maximum capacity).
-----	The weight is underloaded.
	Restricted transmitter: -100 divisions.
	Non-restricted transmitter: -maximum capacity -9 divisions.
<i>Gross .Er</i>	You are trying to print with a non-positive gross weight (less than or equal to zero).
<i>net .Err</i>	You are trying to print with a non-positive net weight (less than or equal to zero).
<i>no .0 .unS</i>	Weight not passed by net 0 or instability.
<i>ConU</i>	You are trying to print while the transmitter is converting the unit of measurement.
<i>Err .CLK</i>	Communication problems with the clock card of the transmitter.
<i>CEL .Err</i>	Signal anomaly: check the connection of the cells.



Complete menu  
on pages 21 - 22

#### MENU ACCESS:

888888 ▲

Press the ▲ key during the start-up procedure.

#### SAVING THE PARAMETERS:

Press the **C** key several times, until the display shows **SAVEP**. Press the **←** key to confirm.









© Rice Lake Weighing Systems    Content subject to change without notice.

230 W. Coleman St. • Rice Lake, WI 54868 • USA    USA: 800-472-6703 • International: +1-715-234-9171