

# 682 Synergy Plus

Digital Weight Indicator

Firmware Version 1.11

## Technical Manual



© Rice Lake Weighing Systems. All rights reserved.

Rice Lake Weighing Systems® is a registered trademark of  
Rice Lake Weighing Systems.

All other brand or product names within this publication are trademarks or  
registered trademarks of their respective companies.

All information contained within this publication is, to the best of our knowledge, complete and  
accurate at the time of publication. Rice Lake Weighing Systems reserves the right to make  
changes to the technology, features, specifications and design of the equipment without notice.

The most current version of this publication, software, firmware and all other product  
updates can be found on our website:

[www.ricelake.com](http://www.ricelake.com)

# Revision History

This section tracks and describes manual revisions for awareness of major updates.

Revision	Date	Description
A	April 8, 2022	Initial manual release with the launch of the product; firmware version 1.00
B	October 28, 2022	Softkey descriptions, custom stream format procedure example and cord grip cable diameter ranges added; print format table and User menu updated; AC/DC models now use same parts kit; firmware version 1.02
C	December 28, 2022	Content updates for DC power cable wiring and batching switch wiring; OIML certificate number added; firmware version 1.03
D	November 8, 2023	Firmware version 1.05; Regulatory parameters and EPD commands expanded; Added power cord details; Updated serial scale input capacities; Added CPU board updates; Updated replacement parts list
E	September 27, 2024	Updated replacement parts; firmware version 1.08
F	November 12, 2024	Updated load cell cable installation procedures
G	March 28, 2025	Added AG features; firmware version 1.11

*Table i. Revision Letter History*



Technical training seminars are available through Rice Lake Weighing Systems. Course descriptions and dates can be viewed at [www.ricelake.com/training](http://www.ricelake.com/training) or obtained by calling 715-234-9171 and asking for the training department.

# Contents

<b>1.0</b>	<b>Introduction</b>	<b>9</b>
1.1	Safety	9
1.2	Disposal	10
1.3	FCC Compliance	10
1.4	Operating Modes	10
1.5	Option Cards	11
1.6	RJ45 Option	11
<b>2.0</b>	<b>Installation</b>	<b>12</b>
2.1	Unpacking	12
2.1.1	Product Dimensions	12
2.2	Mounting Instructions	13
2.3	Backplate Removal	14
2.4	Torque Ratings	14
2.5	Cable Connections	15
2.5.1	Cable Diameter Ranges	15
2.5.2	Cable Shield Grounding	16
2.5.3	AC Power Cable	17
2.5.4	DC Power Cable	17
2.5.5	Load Cell Cables	18
2.5.6	RS-232 Serial Communications	18
2.5.7	RS-485/422 Serial Communications	19
2.5.8	Digital I/O	19
2.5.9	Memory Card Slot	19
2.5.10	Micro USB Device Communications	19
2.5.11	Ethernet	21
2.6	CPU Board	22
2.6.1	Option Card Port	22
2.6.2	Load Cell Compensation Jumper	23
2.7	Backplate Attachment	23
2.8	Sealing the Indicator (Optional)	24
2.9	Parts Kit Components	24
2.10	Replacement Parts	25
2.10.1	682 AC Models	25
2.10.2	682 DC Models	27
<b>3.0</b>	<b>Operation</b>	<b>29</b>
3.1	Front Panel	29
3.2	Status Annunciators	30
3.3	General Navigation	30
3.3.1	Numeric Value Entry	30
3.3.2	Alphanumeric Entry	31
3.4	General Indicator Operation	32
3.4.1	Zero Scale	32
3.4.2	Print Ticket	32
3.4.3	Toggle Units	32
3.4.4	Toggle Gross/Net Mode	32
3.4.5	Acquire Tare	32
3.4.6	Remove Stored Tare Value	32



Rice Lake continually offers web-based video training on a growing selection of product-related topics at no cost. Visit [www.ricelake.com/webinars](http://www.ricelake.com/webinars)

3.4.7	Preset Tare (Keyed Tare)	33
3.4.8	Display a Stored Tare	33
3.4.9	Clear a Stored Tare	33
3.4.10	View Audit Trail Counters	33
3.4.11	View Legally Relevant Version	34
3.4.12	Display Accumulator	34
3.4.13	Print Accumulator	34
3.4.14	Clear Accumulator	34
3.4.15	View and Edit Time Value	35
3.4.16	View and Edit Date Value	36
3.4.17	Ethernet, Wi-Fi and Bluetooth® MAC IDs	37
3.4.18	View Configured Setpoint Values	37
3.4.19	Configure Softkeys	38
3.4.20	Alibi Storage	38
3.4.21	Enter New Unit ID	39
3.4.22	Passwords	39
3.4.23	Reset Configuration	39
<b>4.0</b>	<b>Configuration</b>	<b>40</b>
4.1	Setup Switch	40
4.1.1	Audit Jumper	40
4.2	Main Menu	41
4.3	Audit Menu	41
4.4	User Menu	42
4.4.1	Accumulator Menu	42
4.5	Setup Menu	43
4.5.1	Configuration Menu	43
4.5.2	Scale Format Menu	45
4.5.3	Calibration Menu	46
4.5.4	Communications Menu	47
4.5.5	Program Menu	53
4.5.6	Print Format Menu	56
4.5.7	Stream Format Menu	58
4.5.8	Setpoint Menu	59
4.5.9	Digital I/O Menu	63
4.5.10	Analog Output Menu	63
4.5.11	Softkey Menu	64
4.6	Tare Menu	65
<b>5.0</b>	<b>Split Mode Configuration</b>	<b>66</b>
5.1	Configure a Multi-Range or Multi-Interval Scale	67
<b>6.0</b>	<b>Calibration</b>	<b>68</b>
6.1	Front Panel Calibration	68
6.1.1	Span Calibration	68
6.1.2	Linear Calibration	69
6.2	Alternative Zero Calibrations	69
6.2.1	Last Zero	69
6.2.2	Temporary Zero	69
6.2.3	Rezero	69
6.3	EDP Command Calibration	70



Technical training seminars are available through Rice Lake Weighing Systems. Course descriptions and dates can be viewed at [www.ricelake.com/training](http://www.ricelake.com/training) or obtained by calling 715-234-9171 and asking for the training department.

<b>7.0 Truck Modes</b> .....	<b>71</b>
7.1 Using the Truck Modes .....	71
7.2 Using the Truck Register Display .....	72
7.3 Weigh-In Procedure .....	73
7.4 Weigh-Out Procedure .....	73
7.5 Single-Transaction Tare Weights and IDs .....	73
<b>8.0 HTTP Web Server</b> .....	<b>74</b>
8.1 Access Procedure .....	74
8.2 Browser Display .....	75
<b>9.0 Wi-Fi &amp; Bluetooth® Communications</b> .....	<b>76</b>
9.1 Bluetooth® Communications .....	76
9.2 Wi-Fi Communications .....	76
9.2.1 Wi-Fi Setup .....	76
9.2.2 Server Configuration .....	80
9.2.3 Client Configuration .....	81
9.2.4 Timeout Configuration .....	82
9.3 Wireless Module Specifications .....	83
<b>10.0 Fieldbus Options Configuration</b> .....	<b>85</b>
10.1 Fieldbus Option Installation .....	85
10.2 682 Fieldbus Configuration .....	86
10.3 EtherNet/IP Configuration .....	87
10.3.1 EDS File Setup .....	87
10.3.2 Generic Module Setup .....	87
10.4 PROFINET Configuration .....	87
10.5 Data From the PLC to the Indicator .....	88
10.5.1 Commands .....	89
10.6 Data From the Indicator to the PLC .....	90
10.6.1 Onboard Digital I/O Status .....	91
10.6.2 Calibration Status .....	91
10.6.3 Command Status .....	91
10.6.4 Scale Status .....	93
10.6.5 Scale Error .....	93
10.7 Standard Calibration Process .....	94
<b>11.0 Revolution</b> .....	<b>95</b>
11.1 Connecting to the Indicator .....	95
11.2 Saving and Transferring Data .....	95
11.2.1 Saving Indicator Data to a PC .....	95
11.2.2 Downloading Configuration Data from PC to Indicator .....	95
11.3 Updating Firmware .....	95
<b>12.0 EDP Commands</b> .....	<b>96</b>
12.1 Key Press Commands .....	96
12.2 Reporting Commands .....	97
12.3 SD Card Commands .....	97
12.4 Reset Configuration Command .....	98
12.5 Scale Parameter Setting Commands .....	98
12.6 Serial Port Setting Commands .....	100
12.6.1 Serial Ports .....	100



Rice Lake continually offers web-based video training on a growing selection of product-related topics at no cost. Visit [www.ricelake.com/webinars](http://www.ricelake.com/webinars)

12.7	Ethernet and USB Setting Commands	101
12.8	Wi-Fi and Bluetooth® Setting Commands	101
12.9	Fieldbus Setting Commands	102
12.10	Alibi Setting Commands	102
12.11	Truck Mode Setting Commands	102
12.12	Stream Setting Commands	103
12.13	Program Commands	103
12.14	Regulatory Commands	104
12.15	Setpoint Commands	104
12.16	Batching Control Commands	105
12.17	Print Format Commands	106
12.18	Digital I/O Commands	106
12.19	Analog Output Commands	107
12.20	Softkey Setting Commands	107
12.21	User String Commands	107
12.22	Weigh Mode Commands	108
<b>13.0</b>	<b>Print Formatting</b>	<b>109</b>
13.1	Print Formatting Tokens	110
13.2	Customizing Print Formats	113
13.3	Non-Human Readable Characters	113
13.4	Configuring Auxiliary Print Formats for LaserLight Control	113
<b>14.0</b>	<b>Setpoints</b>	<b>116</b>
14.1	Continuous and Batch Setpoints	116
14.2	Batch Operations	118
14.2.1	Batching Switch	118
14.3	Batching Examples	120
14.3.1	Example 1	120
14.3.2	Example 2	121
<b>15.0</b>	<b>Maintenance</b>	<b>122</b>
15.1	Maintenance Checkpoints	122
15.2	Field Wiring	122
15.3	Troubleshooting Tips	122
15.4	Battery Replacement	123
15.5	Board Replacement	124
<b>16.0</b>	<b>Appendix</b>	<b>125</b>
16.1	Error Messages	125
16.1.1	Displayed Error Messages	125
16.2	Audit Trail Support	126
16.3	Unit Conversion Factors	126
16.4	ZZ EDP Command	126
16.5	Continuous Data (Stream) Output Formats	127
16.5.1	Rice Lake Weighing Systems Stream Format (RLWS)	127
16.5.2	Cardinal Stream Format (Cardinal)	127
16.5.3	Avery Weigh-Tronix Stream Format (Weigh-Tronix)	128
16.5.4	Mettler Toledo Stream Format (Toledo)	128
16.5.5	Minebea Stream Format (Minebea)	129
16.6	Custom Stream Formatting	129



Technical training seminars are available through Rice Lake Weighing Systems. Course descriptions and dates can be viewed at [www.ricelake.com/training](http://www.ricelake.com/training) or obtained by calling 715-234-9171 and asking for the training department.

16.7	Digital Filtering .....	131
16.7.1	Digital Rolling Average Filter (Average Only).....	131
16.7.2	Adaptive Filter (Adaptive Only) .....	132
16.7.3	Damping Filter (Damping Only) .....	133
16.8	Regulatory Mode Functions .....	134
16.9	ASCII Character Chart .....	135
<b>17.0</b>	<b>Compliance .....</b>	<b>136</b>
<b>18.0</b>	<b>Specifications .....</b>	<b>138</b>



*Rice Lake continually offers web-based video training on a growing selection of product-related topics at no cost. Visit [www.ricelake.com/webinars](http://www.ricelake.com/webinars)*



# 1.0 Introduction

This manual is intended for use by service technicians responsible for installing and servicing 682 digital weight indicators. Configuration and calibration of the indicator can be accomplished using the Revolution® configuration utility or the indicator front panel keys. See [Section 4.0 on page 40](#) and [Section 6.0 on page 68](#) for information about configuration and calibration.



Manuals are available from Rice Lake Weighing Systems at [www.ricelake.com/manuals](http://www.ricelake.com/manuals)

Warranty information is available at [www.ricelake.com/warranties](http://www.ricelake.com/warranties)

## 1.1 Safety

### Safety Signal Definitions:



**DANGER:** Indicates an imminently hazardous situation that, if not avoided, will result in death or serious injury. Includes hazards that are exposed when guards are removed.



**WARNING:** Indicates a potentially hazardous situation that, if not avoided, could result in serious injury or death. Includes hazards that are exposed when guards are removed.



**CAUTION:** Indicates a potentially hazardous situation that, if not avoided, could result in minor or moderate injury.



**IMPORTANT:** Indicates information about procedures that, if not observed, could result in damage to equipment or corruption to and loss of data.

### General Safety



**Do not operate or work on this equipment unless this manual has been read and all instructions are understood. Failure to follow the instructions or heed the warnings could result in injury or death. Contact any Rice Lake Weighing Systems dealer for replacement manuals.**



**WARNING:** Failure to heed could result in serious injury or death.

**Dispose of batteries at appropriate waste collection centers at the end of their life cycle in accordance with local laws and regulations. Batteries and rechargeable batteries may contain harmful substances that should not be disposed of in household waste. Batteries may contain harmful substances including but not limited to: cadmium (Cd), lithium (Li), mercury (Hg) or lead (Pb). Users who dispose of batteries illegally shall face administrative sanctions as provided by law.**

**Some procedures described in this manual require work inside the indicator enclosure. These procedures are to be performed by qualified service personnel only.**

**Do not allow minors (children) or inexperienced persons to operate this unit.**

**Do not operate without the enclosure completely assembled.**

**Do not place fingers into slots or possible pinch points.**

**Do not use this product if any of the components are cracked.**

**Do not make alterations or modifications to the unit.**

**Do not remove or obscure warning labels.**

**Do not submerge.**

**Do not use solvents or aggressive substances to clean the indicator.**

**Do not exceed the rated specification of the unit.**

**Only connect unit to equipment certified to IEC 60950, IEC 62368, IEC 61010 or similar.**

**Do not use for purposes other than weight taking.**

**Before opening the unit, ensure the power cord is disconnected from the power source.**

**Disconnect all power before servicing. Multiple power sources may be present. Failure to do so may cause property damage, personal injury or death.**

**For permanently connected equipment, a readily accessible disconnect device shall be incorporated in the building installation wiring.**

**Pluggable units must be installed near the socket/outlet and be easily accessible.**

**Use copper or copper-clad aluminum conductors only.**



**IMPORTANT:** All included batteries intended for sale in the EU market are classified as "Portable Batteries for General Use" and comply with European Battery Regulation (EU) 2023/1542.

## 1.2 Disposal



### Product Disposal

The product must be brought to appropriate separate waste collection centers at the end of its life cycle.

Proper separate collection to recycle the product helps prevent possible negative effects on the environment and to health, and promotes the recycling of the materials. Users who dispose of the product illegally shall face administrative sanctions as provided by law.

### Battery Disposal

Dispose of batteries at appropriate waste collection centers at the end of their life cycle in accordance with local laws and regulations. Batteries and rechargeable batteries may contain harmful substances that should not be disposed of in household waste. Batteries may contain harmful substances including but not limited to: cadmium (Cd), lithium (Li), mercury (Hg) or lead (Pb). Users who dispose of batteries illegally shall face administrative sanctions as provided by law.



**WARNING:** Risk of fire and explosion. Do not burn, crush, disassemble or short-circuit lithium batteries.

## 1.3 FCC Compliance

### United States

This equipment has been tested and found to comply with the limits for a Class A digital device, pursuant to Part 15 of the FCC Rules. These limits are designed to provide reasonable protection against harmful interference when the equipment is operated in a commercial environment. This equipment generates, uses and can radiate radio frequency energy and, if not installed and used in accordance with the instruction manual, may cause harmful interference to radio communications. Operation of this equipment in a residential area is likely to cause harmful interference in which case the user will be required to correct the interference at his own expense.

### Canada

This digital apparatus does not exceed the Class A limits for radio noise emissions from digital apparatus set out in the Radio Interference Regulations of the Canadian Department of Communications.


Le présent appareil numérique n'émet pas de bruits radioélectriques dépassant les limites applicables aux appareils numériques de la Class A prescrites dans le Règlement sur le brouillage radioélectrique édicté par le ministère des Communications du Canada.

## 1.4 Operating Modes

### Weigh Mode


*Weigh* mode is the default mode of the indicator. The indicator displays gross or net weights as required.

### User Mode

*User* mode is accessible by pressing  on the front panel. Access to the Audit, User, Tare, MAC ID, Fieldbus Version and Version menus is available when in *User* mode. Access to the User menu can be password protected ([Section 3.4.22 on page 39](#)). The User menu includes the Setpoint (limited), Accumulator, Time and Date menus.

### Setup Mode

Many of the procedures described in this manual, require the indicator to be in *Setup* mode.

See [Section 4.0 on page 40](#) for the procedure to enter *Setup* mode and the parameters available. *Setup* mode is accessible by pressing the setup switch or by pressing  on the front panel when the audit jumper is in the ON position. Access to the Setup menu can also be password protected ([Section 3.4.22 on page 39](#)).



**NOTE:** See [Section 4.5.5 on page 53](#) for the menu location and description of the password parameters.

## 1.5 Option Cards

The 682 has a single option card slot which can support the Synergy Series Option Cards. The Synergy Series Option Card kits include instructions for installation and setup.

- Single Analog Output Option Card Kit (PN 195084)
- Relay Option Card Kit (PN 211709)
- Dual Serial Option Card Kit (PN 211710)

## 1.6 RJ45 Option

The 682 is available with an external RJ45 option. This external RJ45 connector is located on the backplate of the 682 and provides quick access to Ethernet TCP/IP 10Base-T/100Base-TX communication ([Section 2.5.11 on page 21](#)).

682 indicators without the RJ45 option access Ethernet using the J8 connector on the CPU board inside of the enclosure.

## 2.0 Installation

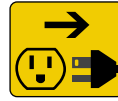
This section describes procedures for connecting power, load cells, digital I/O and data communication cables to a 682 indicator. An assembly drawing and parts list are included for the service technician.



**WARNING**



*Risk of electrical shock.  
Risque de choc.*



*Disconnect power before servicing.  
Débranchez l'alimentation avant l'entretien.*



**AVERTISSEMENT**



**CAUTION:** *Risk of explosion if battery is replaced by an incorrect type. Dispose of used batteries according to state and local regulations.*



**ATTENTION:** *Risque d'explosion si la batterie est remplacée par un type incorrect. Mettre au rebut les batteries usagées selon les règlements d'état et locaux.*



**WARNING:** *Failure to heed the following statements could result in serious injury or death.*

- *Procedures requiring work inside the product enclosure must be performed by qualified service personnel only.*
- *Use a grounding wrist strap to protect components from electrostatic discharge (ESD) damage when working inside the product enclosure.*
- *The power outlet must be near the equipment and must be easily accessible.*

### 2.1 Unpacking

Immediately after unpacking, visually inspect the 682 to ensure all components are included and undamaged. The shipping carton contains the indicator, this manual and a parts kit. If parts were damaged in shipment, notify Rice Lake Weighing Systems and the shipper immediately.

#### 2.1.1 Product Dimensions

This section includes exterior product dimensions of the 682 enclosure and universal stand.

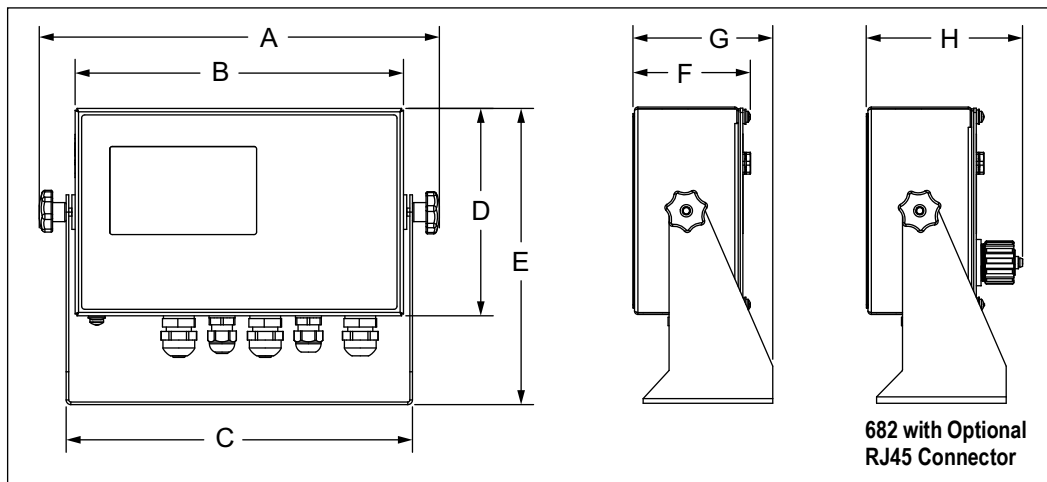


Figure 2-1. Product Dimensions Diagram

A	B	C	D	E	F	G	H
11.6 in (294.7 mm)	9.5 in (241.3 mm)	10.0 in (254.0 mm)	6.0 in (152.4 mm)	8.6 in (218.5 mm)	3.5 in (88.9 mm)	4.0 in (101.6 mm)	4.5 in (114.3 mm)

Table 2-1. Product Dimensions

## 2.2 Mounting Instructions

The 682 includes a universal mount stand. The stand can be mounted on a wall, tabletop or a flat surface.

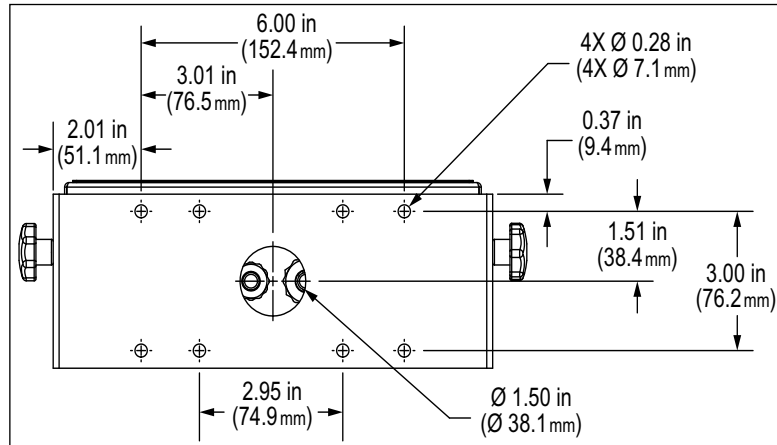


Figure 2-2. Mounting Dimensions Diagram



**NOTE:** The universal mount stand comes attached to the 682. Rice Lake Weighing Systems recommends removing the 682 from the stand prior to mounting.

1. Using the mount as a template, mark the screw locations.
2. Drill holes for the screws.
3. Secure the universal mount using the appropriate 1/4-inch or M6 hardware (not included).
4. Reattach the 682 to the universal mount stand.

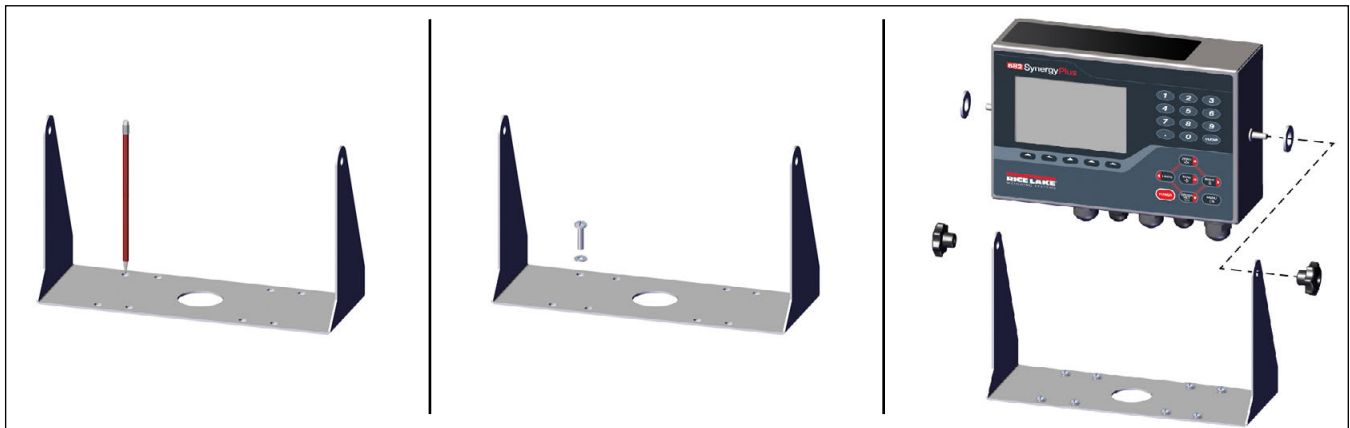


Figure 2-3. Mounting the Indicator



**NOTE:** The parts kit includes rubber grommets to insert into the four screw holes of the universal mount stand for a non-mounted application.

## 2.3 Backplate Removal

Remove the backplate of the 682 to connect cables and gain access to the 682 board and power supply.



**WARNING:** Before opening the unit, ensure the power cord is disconnected from the power outlet.

1. Place the 682 facedown on an anti-static work mat.
2. Remove the screws holding the backplate to the enclosure.
3. Lift the backplate away from the enclosure and disconnect the ground wire from the backplate.

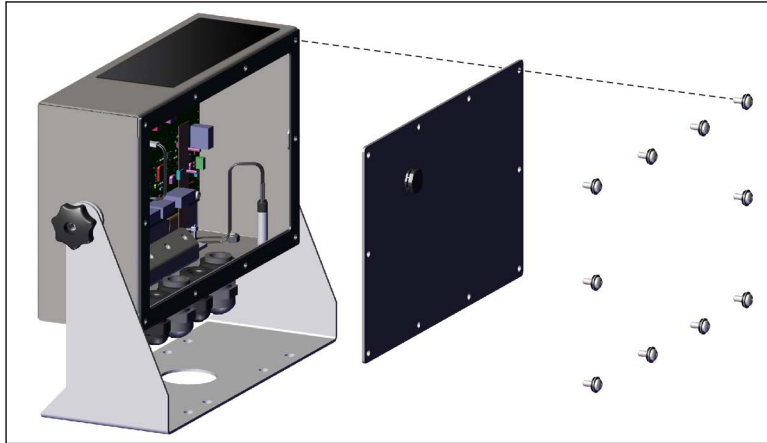


Figure 2-4. Removing the Backplate



**NOTE:** The 682 ships with only four screws securing the backplate. The remaining backplate screws are included in the parts kit. For reassembly, torque backplate screws to 12 in-lb (1.4 N-m).

## 2.4 Torque Ratings

Refer to [Table 2-2](#) throughout installation and use of product to maintain proper torque ratings for 682 components.

Component	Torque Rating
Backplate Screw	12 in-lb (1.4 N-m)
Setup Screw	10 in-lb (1.1 N-m)
Power Supply Bracket	4 in-lb (0.46 N-m)
Cord Grip Nut (to enclosure)	33 in-lb (3.7 N-m)
Cord Grip Dome Nut (around cable)	22 in-lb (2.5 N-m)
Optional RJ45 Panel Nut	20 in-lb (2.3 N-m)

Table 2-2. Component Torque Ratings

## 2.5 Cable Connections

The 682 provides five cord grips at the bottom of the enclosure for cabling into the indicator. One of the cord grips is used for the power supply and the other four are used to accommodate the load cell cable and the serial, digital inputs and outputs, Ethernet, micro USB or the optional analog output communications cables. A version of the 682 with an external RJ45 connector and cap is available. Cable plugs are included in the parts kit and must be installed in open cord grips to prevent moisture from entering the enclosure. Use the attached cap to seal the optional RJ45 connector when not in use. See the following sections to install cables as required for the application. The recommended cable strip length is 0.25 in (7 mm) for all 682 connectors. See [Figure 2-5](#) for the recommended assignments for the 682 cord grips.



**IMPORTANT:** Prohibit open/bare wires outside of enclosure. Ensure stripped portion of cables are entirely inside cord grips. Properly seal cord grips to prevent moisture damage inside of the enclosure. Cable plugs must be installed in unused cord grips. Cord grip dome nuts, around a cable or a plug, must be torqued to 22 in-lb (2.5 N-m). The cord grip nut against the enclosure must be torqued to 33 in-lb (3.7 N-m).



**WARNING:** Only connect unit to equipment certified to IEC 60950, IEC 62368, IEC 61010 or similar.



Figure 2-5. Recommended Cord Grip Assignments



**NOTE:** The recommended cable strip length is 0.25 in (7 mm) for all 682 connectors.

### 2.5.1 Cable Diameter Ranges

Refer to [Table 2-3](#) for minimum and maximum cable diameter sizes for use with the 682 cord grips.

Cord Grip	Diameter Range
PG-9 (PN 15626)	0.138 - 0.315 in (3.5 - 8 mm)
PG-11 (PN 68600)	0.197 - 0.394 in (5 - 10 mm)

Table 2-3. Cord Grip Cable Diameter Ranges

## 2.5.2 Cable Shield Grounding

Except for the power cord, all cables routed through the cord grips must be shield grounded against the enclosure.

- Use hardware provided in parts kit to install shielding clamps on the grounding bracket at the bottom of the enclosure.
- Install only the necessary amount of shielding clamps for the cord grips to be used.
- Remove the insulated jackets and shielding per the following instructions.

### Shielding Procedure

1. Install the shielding clamps on the grounding rail using the clamp screws. Finger tighten the screws at this time.
2. Route the cables through the cord grips and the shielding clamps to determine the cable lengths required to reach the appropriate cable connectors.
3. Mark cables to remove the insulated jacket as described below for Foil Shielded Cables and Braid Shielded Cables.

### Foil Shielded Cables

Use the following procedure to shield ground foil shielded cables.

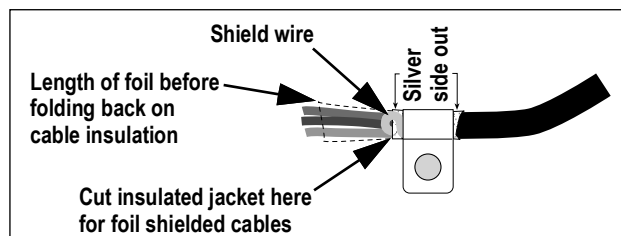


Figure 2-6. Foil Shielded Cable

1. Strip the insulated jacket and foil 1/2 in (15 mm) past the shielding clamp.
2. Strip another 1/2 in (15 mm) of the insulated jacket, leaving the foil shielding exposed.
3. Fold the foil shielding back on the cable where the cable passes through the clamp.
4. Ensure the silver (conductive) side of the foil is turned outward.
5. Wrap the shield wire around the cable, ensuring it contacts the foil where the cable passes through the clamp.
6. Torque shielding clamp screw to 10 in-lb (1.1 N-m), ensuring clamp is around the cable and contacting the shield wire.

### Braid Shielded Cables

Use the following procedure to shield ground braid shielded cables.

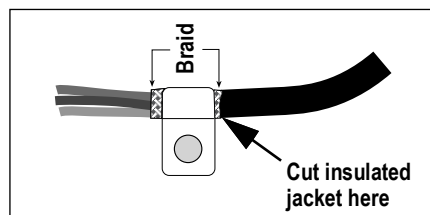


Figure 2-7. Braid Shielded Cable

1. Strip the insulated jacket and braided shielding from a point just past the shielding clamp.
2. Strip another 1/2 in (15 mm) of the insulated jacket, leaving braid exposed where the cable passes through the clamp.
3. Torque shielding clamp screw to 10 in-lb (1.1 N-m), ensuring the clamp is contacting the braided shielding of the cable.



### 2.5.3 AC Power Cable

AC versions of the 682 are shipped with the AC power cable already installed.



Figure 2-8. AC Power Cable



**NOTE:** The AC power cable is grounded to the threaded grounding hole on the back panel of the enclosure between the cord grip and the power supply connections rather than using Pin 3. This is a UL requirement.

Pin	Description	Wire Color	Cable Part No.
1	120 VAC (Line In)	Brown or Black	180842
2	AC Neutral	Blue or White	
3	Ground	N/C or Green/Yellow	–
4	DC Out (-V)	Black	199514
5	DC Out (+V)	Red	

Table 2-4. AC Power Supply Pin Assignments



**NOTE:** Colors may vary depending on manufacturer of AC power cable. Utilize testing procedures to ensure proper installation.

### 2.5.4 DC Power Cable

DC models of the 682 do not include a power supply cable. Use the following steps to ground and connect a DC power cable.

1. Insert a 3-wire power cable (not included) into the enclosure through the power cable cord grip (Section 2.5 on page 15).



**NOTE:** The recommended wire gauge range for the power supply cable is 8-18 AWG. The recommended cable strip length is 0.25 in (7 mm) for all 682 connectors. See Section 2.4 on page 14 for proper torque ratings for the power cable cord grip and Section 2.5.1 on page 15 for the allowed cable diameter range.

2. Connect the three wires of the power cable to the DC power supply board input screw terminal (I/P). See Table 2-5 for the input terminal (I/P) pin assignments.

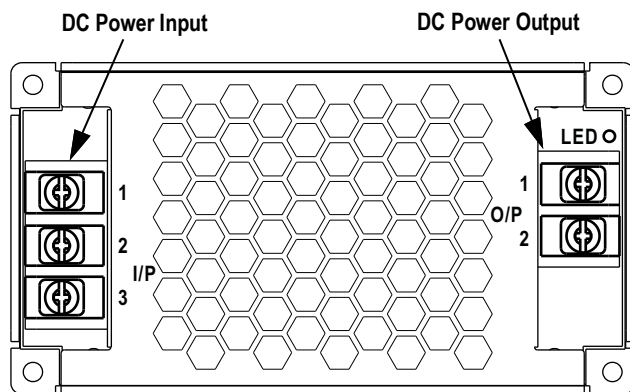


Figure 2-9. DC Power Supply Board (PN 209417)

Connector	Pin	Function
Input Terminal (I/P)	1	DC Input V+
	2	DC Input V-
	3	Ground $\pm$ (FG)

Connector	Pin	Function
Output Terminal (O/P)	1	DC Output V-
	2	DC Output V+

Pre-installed wiring connects power supply board to CPU board.

Table 2-5. DC Power Pin Assignments



**IMPORTANT:** A 3-wire power cable is required and the ground wire must be connected to the specified pin assignment on the DC power supply board.

### 2.5.5 Load Cell Cables

To connect the cable from a load cell or junction box, route cable to the J1 connector ([Section 2.6 on page 22](#)). Connector for the cable is included in the parts kit. See [Table 2-6](#) for pinout information.



**A snap-on ferrite core from the parts kit must be applied to the load cell cable within 1 in (25 mm) of the load cell or within 1 in (25 mm) of the junction box on the homerun cable. The cable must be sent through the ferrite core twice.**

Connector	Pin	Function
J1	1	+SIG
	2	-SIG
	3	+SENSE
	4	-SENSE
	5	+EXC
	6	-EXC

Table 2-6. J1 Pin Assignments (Load Cell)

### Configuring Sense Parameter

The Sense parameter is set to 4-wire by default and must be configured to match the load cell cable to function properly.

Wire Connections	Board Revision	Configuration
4-Wire	A-J1	Leave pins 3 and 4 empty on the connector
	J2	Wire jumper pin 3 to 5 and pin 4 to 6
	K	Leave shunts on jumper pins J28 and J32
6-Wire	A-J2	Set the SENSE parameter to 6-WIRE in the CONFIG menu ( <a href="#">Section 4.4.1 on page 42</a> )
	K	Remove shunts from jumper pins J28 and J32 before installing connector J1

Table 2-7. CPU Board Load Cell Cable Connection Requirements

### 2.5.6 RS-232 Serial Communications

The J3 connector ([Section 2.6 on page 22](#)) provides a connection point for RS-232 serial communications. Two RS-232 ports are available. See [Table 2-8](#) for the pin assignments for the J3 connector.

Connector	Pin	RS-232 Port 1	RS-232 Port 2
J3	1	GND	-
	2	RX1	-
	3	TX1	-
	4	-	GND
	5	-	RX2
	6	-	TX2

Table 2-8. J3 Pin Assignments (RS-232)

## 2.5.7 RS-485/422 Serial Communications

The J4 connector (Section 2.6 on page 22) provides a connection point for RS-485/422 serial communications. Both full duplex (four-wire) and half duplex (two-wire) are supported through the J4 connector. See Table 2-9 for the pin assignments for the J4 connector.

Connector	Pin	4-Wire (Full Duplex)	2-Wire (Half Duplex)
J4	1	GND	GND
	2	A	–
	3	B	–
	4	Y	Y
	5	Z	Z

Table 2-9. J4 Pin Assignments (RS-485/422)



**The Duplex parameter in the Serial menu (Section 4.5.4.1 on page 47) defaults to FULL and must be set to HALF for half duplex applications.**

## 2.5.8 Digital I/O

The Digital I/O port, J5 connector (Section 2.6 on page 22), provides a connection to both digital inputs and outputs.

Digital inputs can be set to provide many functions, including most keypad functions except MENU, numeric keypad and softkeys. Digital inputs are active low (0 VDC) and inactive high (5 VDC). Use the Digital I/O menu to configure the digital inputs.

Digital outputs are used to control relays which drive other equipment. Outputs are designed to sink, rather than source current. Each output is an open collector circuit, capable of sinking 20 mA when active. Digital outputs are active when low or at 0 VDC, with reference to the 5 VDC supply.

Use the Digital I/O menu to set the function of the Digital I/O pins to OUTPUT and then use the Setpoints menu to configure the digital outputs. See Table 2-10 for the pin assignments for the J5 connector.

Connector	Pin	Signal
J5	1	5 VDC, 250 mA max
	2	GND
	3	DIO1
	4	DIO2
	5	DIO3
	6	DIO4

Table 2-10. J5 Pin Assignments (Digital I/O)

## 2.5.9 Memory Card Slot

The memory card slot, J6 connector (Section 2.6 on page 22), accepts microSD cards and provides storage space for configuration settings (Section 12.3 on page 97) and Truck IDs. The 682 comes with an 8 GB microSD card (PN 164939) and the memory card slot supports up to a 2 TB microSD card.



**NOTE: The microSD card only functions with the 682. It is not formatted in FAT32 and will not be recognized by a PC. Ensure indicator firmware versions match before transferring a microSD card from one indicator to another.**

## 2.5.10 Micro USB Device Communications

The Micro USB port, J7 connector (Section 2.6 on page 22), provides a connection point to a PC only. It appears as a Virtual COM Port and is assigned a “COMx” designation. Applications communicate through the port like a standard RS-232 communications port.

The driver must be installed on the PC before the Micro USB device port can be used. With the PC and 682 powered on, connect a USB cable from the PC to the Micro USB connector (J7) on the 682. The PC recognizes if a device has been connected, and attempts to install the driver needed to make it work. The driver can also be downloaded from [www.ricelake.com](http://www.ricelake.com).



**NOTE: With a PC connected to the Internet and running Windows 7 or later, the operating system may install the necessary drivers automatically.**

When the individual drivers are installed, a new COM Port designation is assigned for each physical USB port the 682 is connected to on the PC.

For example, if the PC has two physical RS-232 COM Ports, they most likely are designated COM1 and COM2. When connecting the 682 to a USB port on the PC, it is assigned the next available port designation, or in this case, COM3. When plugging into the same physical USB port on the PC, the port designation is again COM3. If plugging into another physical USB port on the PC, it is assigned the next available designation, in this case COM4.

After the drivers are installed, use Windows® Device Manager to determine the COM Port designation which was assigned to the USB port, or open an application to be used with the 682, such as Revolution, to see which ports are available.

Configuration of the Micro USB port is done in the USB sub-menu under Communications when in *Setup* mode.

The port's input trigger can be configured as either a command port for EDP commands and printing, or as a data streaming port. Other settings include line terminator, end-of-line delay, echo, and response ([Section 4.5.4.2 on page 49](#)).



**NOTE:** *If a computer application has an open communications connection through the Micro USB device port and the physical cable connection is interrupted, a soft reset must be performed on the 682 or the power must be cycled to the 682; the connection in the computer application must be disconnected and then reconnected before it continues to communicate with the 682.*

**NOTE:** *For the Micro USB device port, it does not matter what the settings are for baud, data bits, parity and stop bits in the computer software. The port communicates in the same way regardless of these settings.*

**NOTE:** *This port is not a host port and is not to be connected to other devices such as keyboards, memory sticks or printers.*

## 2.5.11 Ethernet

The 682 features Ethernet TCP/IP 10Base-T/100Base-TX communication using the J8 connector ([Section 2.6 on page 22](#)), and can support two simultaneous connections, one as a server, the other as a client. An external RJ45 option is available.

Through an Ethernet network, software applications can communicate with the 682 using the EDP command set ([Section 12.0 on page 96](#)), the web server ([Section 8.0 on page 74](#)) allows for remote viewing and the use of certain function keys, or data can be streamed continuously from the 682, or printed on demand.

The Ethernet port supports both DHCP and manual configuration of settings such as the IP and netmask. In addition, the TCP Port number and the Default Gateway can be configured using the Ethernet sub-menu under Communications when in *Setup* mode. For more information on configuring the Ethernet port see [Section 4.5.4.3 on page 50](#).

Physical connection to the 682 Ethernet port can be made directly from a PC to the 682 (AdHoc Network), or through a network router or switch. The port supports auto-sensing MDI/MDIX cable configuration, allowing either straight-through or crossover cables to be used. See [Table 2-11](#) for the pin assignments for the J8 connector.

Connector	Pin	Signal
J8	1	TX+
	2	TX-
	3	RX+
	4	RX-

Table 2-11. J8 Pin Assignments (Ethernet)



**NOTE:** When looking into the enclosure from the backside of the indicator, pin 1 of the J8 connector is at the bottom.

See [Table 2-12](#) and [Table 2-13](#) for the pin assignments when connecting an RJ45 Ethernet cable to the J8 connector. There are two Ethernet wire standards (T568A and T568B). If the type of cable is unknown, use the wiring option in [Table 2-12](#). The auto-sensing feature of the Ethernet port allows either of the wiring options to work. Trim the unused wires to get them out of the way.

RJ45 Pin	Wire Color (T568A)	Wire Diagram (T568A)	10Base-T Signal 100Base-TX Signal	J8 Pin
1	White/Green		Transmit+	1
2	Green		Transmit-	2
3	White/Orange		Receive+	3
4	Blue		Unused	NA
5	White/Blue		Unused	NA
6	Orange		Receive-	4
7	White/Brown		Unused	NA
8	Brown		Unused	NA

Table 2-12. Ethernet Cable Pin Assignments for T568A

RJ45 Pin	Wire Color (T568B)	Wire Diagram (T568B)	10Base-T Signal 100Base-TX Signal	J8 Pin
1	White/Orange		Transmit+	1
2	Orange		Transmit-	2
3	White/Green		Receive+	3
4	Blue		Unused	NA
5	White/Blue		Unused	NA
6	Green		Receive-	4
7	White/Brown		Unused	NA
8	Brown		Unused	NA

Table 2-13. Ethernet Cable Pin Assignments for T568B



## 2.6.2 Load Cell Compensation Jumper

The load cell compensation jumper, J29 (Section 2.6 on page 22), must be set ON for load cells with balanced bridges and set to OFF for load cells with unbalanced bridges. When OFF, the compensation jumper has the effect of lowering the excitation voltage. Uncompensated unbalanced load cells can cause instability or calibration errors.

Use the following procedure to determine the correct jumper position if the load cell type is unknown.

1. Disconnect load cell from indicator and use an ohmmeter to measure the following:
  - +EXC to +SIG, +EXC to –SIG
  - –EXC to +SIG, –EXC to –SIG



**NOTE:** Measured values between the excitation line and each of the signal lines should be within 2–3  $\Omega$ .

2. If the +EXC measurements are  $\geq 5\%$  larger than the –EXC measurements, set the compensation jumper in the OFF position to compensate for the unbalanced load cell.  
If the +EXC measurements are  $< 5\%$  greater (or are less) than the –EXC measurements, set the jumper in the ON position for the balanced load cell.

## 2.7 Backplate Attachment

Once work inside of the enclosure is complete, reattach the backplate ground wire to the backplate. Position the backplate over the enclosure and install the ten backplate screws. Use the torque pattern in Figure 2-11 to prevent distorting the backplate gasket. Torque screws to 12 in-lb (1.4 N-m).

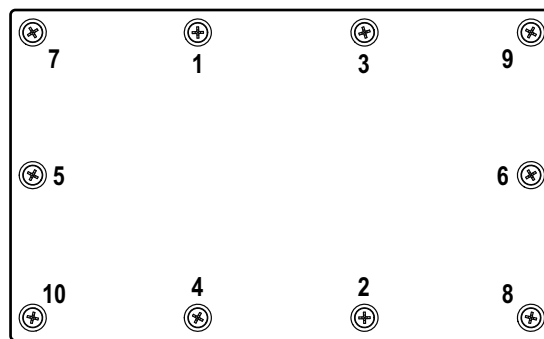


Figure 2-11. Backplate Torque Pattern



**NOTE:** Torqued screws may become less tight as the gasket is compressed during the torque pattern; a second torque is required using the same pattern and torque value.

## 2.8 Sealing the Indicator (Optional)

Insert a lead wire seal through three fillister screws. This restricts access of the setup switch, electronics, electrical contacts and Legal for Trade configuration parameters.



**NOTE:** The audit jumper (J24) must be set to off to require pressing the setup switch for access to configuration parameters. See [Section 2.6 on page 22](#) for the location of the audit jumper on the CPU board.

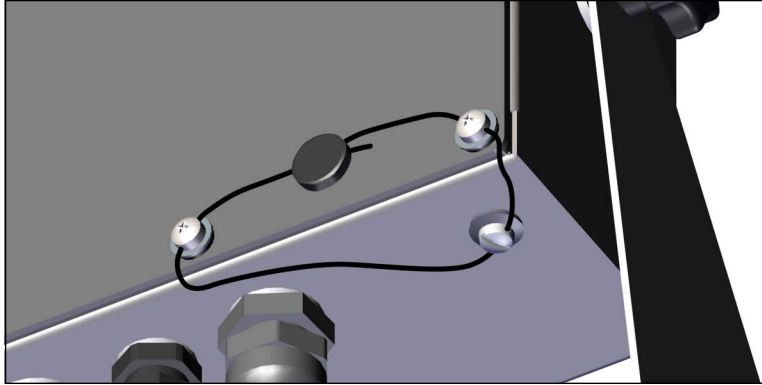


Figure 2-12. Sealing the Indicator – No Access

1. Reposition the two fillister head backplate screws to the lower right and lower right-center screws locations.
2. Torque the two backplate screws and setup screw as specified in [Section 2.4 on page 14](#).
3. Navigate the sealing wire through the fillister head screws on the backplate and the fillister head screw at the bottom of the enclosure, as shown in [Figure 2-12](#).
4. Seal the wire to secure.

## 2.9 Parts Kit Components

Part No.	Description	Qty.
15631	Cable tie, 3 inch nylon	4
15650	Mount, cable tie 3/4 inch	2
193230	Screw, machine M4-0.7 x 10 Phillips pan head SST	4
194219	Screw, machine M4-0.7 x 10 Phillips drilled cheese head SST	2
194446	Ferrite core, snap on Fair-Rite 220 ohm	1
19538	Post plug, slotted black plastic stem, 1/4 x 1, seals inside cord grip	3
195993	Connector, 6 position screw terminal pluggable 3.50 mm black	3
195995	Connector, 4 position screw terminal pluggable 3.50 mm black	1
195998	Connector, 5 position screw terminal pluggable 3.50 mm black	1
214338	Screw, machine M4-0.7 x 10 Phillips pan head, zinc with external tooth washer SEMS	4
42149	Bumper, rubber grommet 0.50 (OD) x 0.281 (ID)	4
53075	Clamp, ground cable shield, radius 0.078 inch	4
67550	Clamp, ground cable shield, radius 0.125 inch	2
75062	Washer, bonded sealing #8 7/16 (0.4375) OD SST	6
94422	Label, capacity 0.40 x 5.00	1

Table 2-14. AC and DC Models Parts Kit (PN 194477)



## 2.10 Replacement Parts

### 2.10.1 682 AC Models

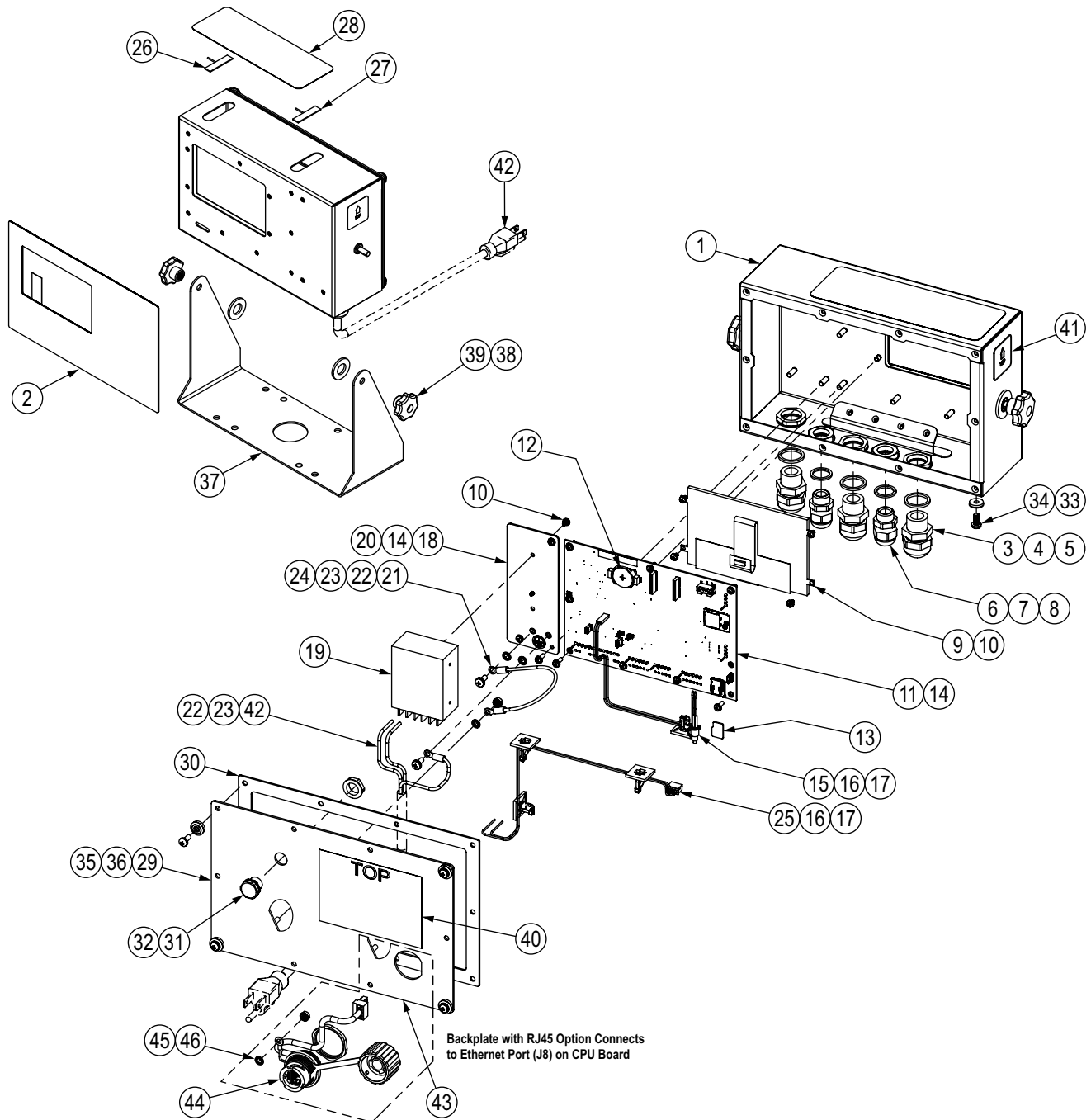


Figure 2-13. 682 AC Models Replacement Parts Diagram

Ref#	Part#	Description
1	190231	Enclosure, 682 Plus indicator LCD display
2	190232	Overlay, 682 Plus membrane switch with numeric keys
3	68600	Cord grip, PG-11
4	68599	Seal ring, PG-11
5	68601	Nut, PG-11, Black nylon
6	15626	Cord grip, PG-9, plastic
7	30375	Seal ring, PG-9 nylon
8	15627	Lock nut, PG-9, plastic
9	202248	Display, 5-inch LCD, 500 NIT, 800 X 480
10	199474	Machine screw M3-0.5 X 5 Phillips head, zinc SEMS with external tooth washer
11	211701	CPU board assembly with battery and memory card installed, ROHS
12	71408	Battery, CR2032 3V lithium
13	164939	Memory, 8G microSDHC Class 4
14	206442	Machine screw, M3-0.5 x 10 Phillips head, zinc SEMS with external tooth washer
15	193108	Setup switch assembly
16	15650	Mount, cable tie, 3/4 inch
17	15631	Cable tie, 3 inch nylon
18	192439	Bracket, power supply
19	193281	Power supply, 12V, 15W
20	16892	Label, ground protective earth IEC
21	15601	Ground wire, 6 inch w/ no. 8 eye connector
22	180856	Washer, M4 internal tooth
23	214338	Machine screw, M4-0.7 x 10 Phillips head, zinc SEMS with external tooth washer
24	180826	Nut, KEP M4 x 0.7 external tooth lock washer
25	193337	Cable assembly, power harness, 2 position, flying lead
26	206509	Antenna, 2.4/5 GHz strip RF, PCB trace 100 mm cable
27	206510	Antenna, 2.4/5 GHz strip RF, PCB trace 200 mm cable
28	207345	Overlay, 682 antenna cover black
29	192562	Backplate with GORE vent hole
30	84388	Gasket, backplate
31	88733	Vent, breather sealed Gortex membrane
32	88734	Nut, breather vent M12 x 1 thread
33	46381	Washer, bonded sealing SST #10 x 0.50 OD
34	180861	Machine screw, M5 x 0.8 x 10 mm slotted drilled cheese head
35	193230	Machine screw, M4 x 0.7 x 10 Phillips pan head
36	75062	Washer, bonded sealing #8, 7/16 OD
37	29635	Tilt stand, SST
38	103988	Washer, nylon 0.515 - 0.52
39	180825	Knob, M6 x 1 threaded, 32-mm diameter
40	53307	Label, 4.0 x 2.875
41	53308	Label, 1.25 x 1.25 8000T
42	180842	Power cord assembly, NEMA 5-15
	180850	Power cord assembly, Europe CEE7/7
	196900	Power cord assembly, UK plug BS1363, pigtail w/ring terminal
	196901	Power cord assembly, Australia/New Zealand 3112 plug, pigtail w/ring terminal
<b>Additional Parts Specific to 682 Indicator with RJ45 Option</b>		
43	198676	Backplate with GORE vent hole, RJ45 option <i>NOTE: Replaces 192562 in RJ45 option</i>
44	200296	RJ45 cable assembly, RJ45 bulkhead to four position 3.50 mm spacing connector
45	180856	Washer, M4 internal tooth
46	180826	Nut, KEP M4 x 0.7 external tooth lock washer

Table 2-15. 682 AC Models Replacement Parts List

2.10.2 682 DC Models

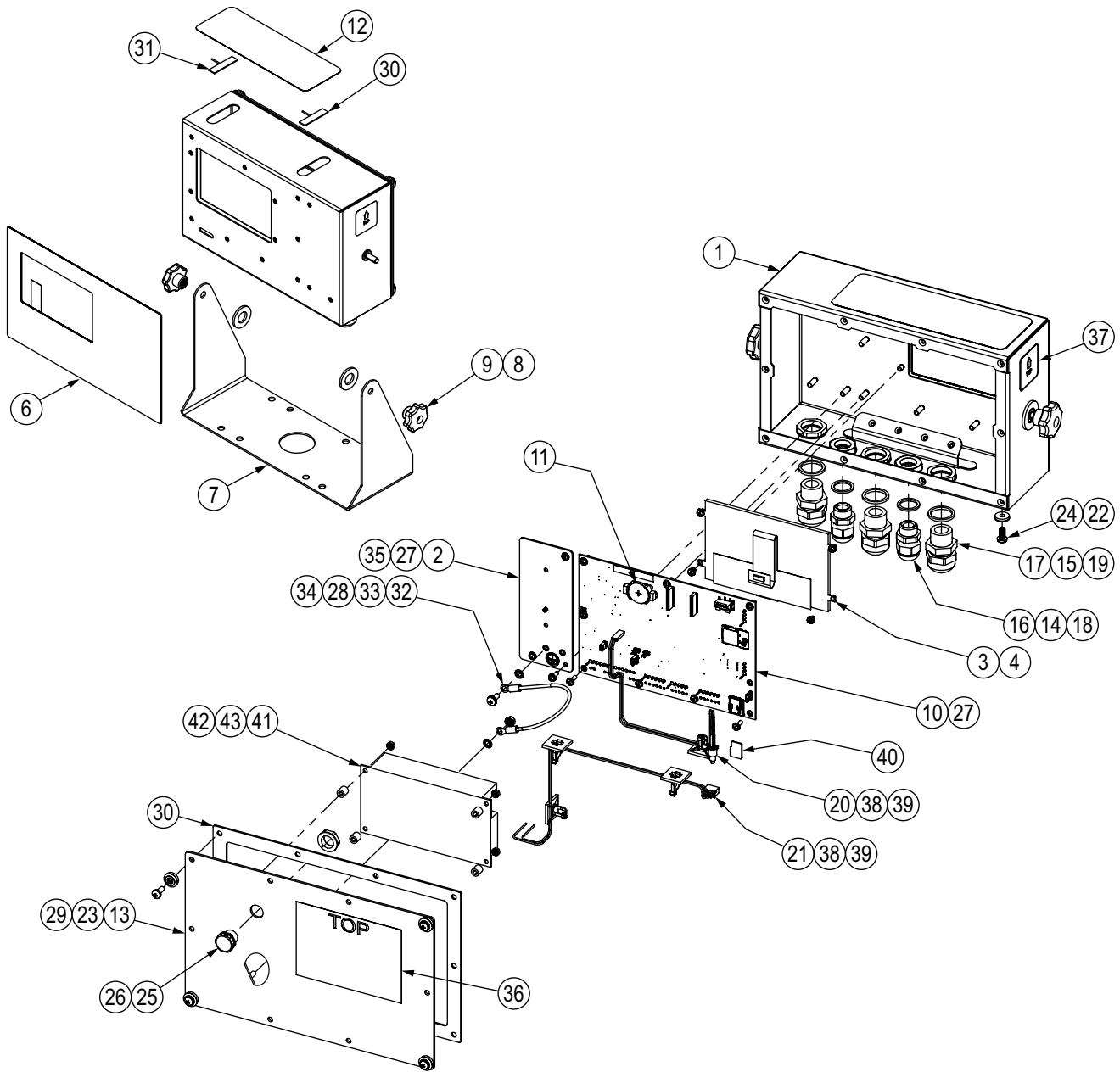


Figure 2-14. 682 DC Models Replacement Parts Diagram

Ref#	Part#	Description
1	190231	Enclosure, 682 Plus indicator LCD display
2	192439	Bracket, power supply
3	199474	Machine screw M3-0.5 X 5 Phillips head, zinc SEMS with external tooth washer
4	202248	Display, 5-inch LCD, 500 NIT, 800 X 480
5	84388	Gasket, backplate
6	190232	Overlay, 682 Plus membrane switch with numeric keys
7	29635	Tilt stand, SST
8	103988	Washer, nylon 0.515 - 0.52
9	180825	Knob, M6 x 1 threaded, 32-mm diameter
10	211701	CPU board assembly with battery and memory card installed, ROHS
11	71408	Battery, CR2032 3V lithium
12	207345	Overlay, 682 antenna cover black
13	211928	Backplate, 682 DC with Gore vent hole
14	30375	Seal ring, PG-9
15	68599	Seal ring, PG-11
16	15626	Cord grip, PG-9
17	68600	Cord grip, PG-11
18	15627	Lock nut, PG-9
19	68601	Lock nut, PG-11
20	193108	Setup switch assembly
21	193337	Cable assembly, power harness, 2 position, flying lead
22	46381	Washer, bonded sealing SST #10 x 0.50 OD
23	75062	Washer, bonded sealing #8, 7/16 OD
24	180861	Machine screw, M5 x 0.8 x 10 mm slotted drilled cheese head
25	88733	Vent, breather sealed Gortex membrane
26	88734	Nut, breather vent M12 x 1 thread
27	206442	Machine screw, M3-0.5 x 10 Phillips head, zinc SEMS with external tooth washer
28	214338	Machine screw, M4-0.7 x 10 Phillips head, zinc SEMS with external tooth washer
29	193230	Machine screw, M4 x 0.7 x 10 Phillips pan head
30	206510	Antenna, 2.4/5 GHz strip RF, PCB trace 200 mm cable
31	206509	Antenna, 2.4/5 GHz strip RF, PCB trace 100 mm cable
32	15601	Ground wire, 6 inch w/ no. 8 eye connector
33	180856	Washer, M4 internal tooth
34	180826	Nut, KEP M4 x 0.7 external tooth lock washer
35	16892	Label, ground protective earth IEC NOTE: Current cases have a ground symbol engraved on the backplate instead of a decal.
36	53307	Label, 4.0 x 2.875
37	53308	Label, 1.25 x 1.25 8000T
38	15650	Mount, cable tie, 3/4 inch
39	15631	Cable tie, 3 inch nylon
40	164939	Memory, 8G microSDHC Class 4
41	209417	Power supply, DC/DC +12V, 9-36VDC input 30 watt
42	202064	Spacer, round nylon M3x0.250 OD x 0.260
43	202061	Nut, M3x0.5 hex KEP SST

Table 2-16. 682 DC Models Replacement Parts List

## 3.0 Operation

The front panel consists of a full color LCD display with 0.5-in (12.7-mm) tall weight digits. The front panel also includes 24 flat membrane panel, tactile feel buttons, which include six primary scale function buttons, a numeric keypad, five configurable softkeys and a power button. The message area of the display can hold up to three lines of text, which can include process, error or system messages.

### 3.1 Front Panel

This section provides an example of the 682 front panel and describes all the buttons and their functions.

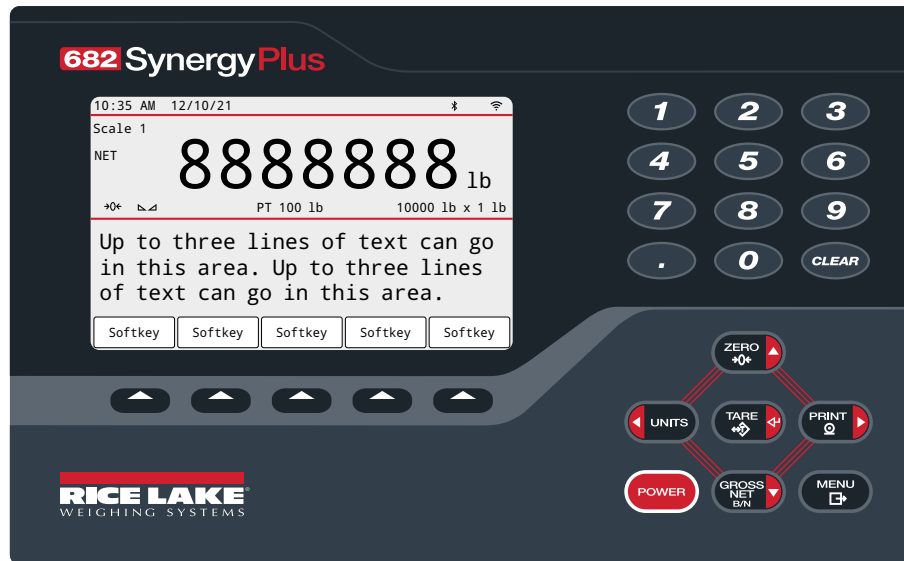


Figure 3-1. Front Panel Example

Button	Function
	Turns the unit ON/OFF: If ON, press and hold for eight seconds to turn unit OFF If OFF, press and hold for two seconds to turn unit ON
	The <b>Menu</b> button is used to access <i>User</i> mode. See <a href="#">Section 4.1.1 on page 40</a> for more information on setting up the <b>Menu</b> button to access <i>Setup</i> mode parameters.
	Sets the current gross weight to zero, provided the amount of weight to be removed or added is within the specified zero range and the scale is not in motion. The zero band is defaulted to 1.9% of full scale, but can be configured for up to 100% of full scale. Also used as the up button to navigate menus.
	Switches the weight display to an alternate unit. The alternate unit is defined in the <b>Configuration</b> menu, and could be kg, g, lb, oz, tn or t. Also used as the left button to navigate menus or to toggle to another digit when editing a value.
	Sends on-demand print format out the configured port, provided the conditions for standstill are met. RS-232 Port 1 (RS232-1) is the default print port. Also used as the right button to navigate menus or to toggle to another digit when editing a value.
	Performs one of several predetermined tare functions dependent on the mode of operation selected in the TARE FN parameter. Also acts as an enter button for numeric or parameter entry.
	Switches the display mode from gross to net, or from net to gross. If a tare value has been entered or acquired, the net value is the gross weight minus the tare. Used as the down button to navigate menus.
	Clears current value in a numeric entry or clears the currently selected digit in an alphanumeric entry.
	Configurable softkeys that can be set to perform a variety of functions. See <a href="#">Section 3.4.19 on page 38</a> to configure softkeys. Also used to select the bottom row of keyboard options located above the softkeys.

Table 3-1. Front Panel Buttons and Descriptions

## 3.2 Status Annunciators

The 682 display uses status annunciators to provide additional information about the value being displayed.











Item	Description
<b>GROSS</b>	Gross displays at the left side of the numeric weight area when indicator is in gross weight display mode.
<b>NET</b>	Net displays at the left side of the numeric weight area when indicator is in net weight display mode.
<b>→0←</b>	The center of zero annunciator indicates the current gross weight reading is within $\pm 0.25$ display divisions of the acquired zero, or is within the center of zero band. A display division is the resolution of the displayed weight value, or the smallest incremental increase or decrease which can be displayed or printed.
<b>▢</b>	The standstill annunciator indicates the scale is at standstill or within the specified motion band. Some operations, including zero, tare and print, can only be done when the standstill annunciator is displayed.
<b>Units</b>	The current unit displays at the right side of the numeric weight area and specifies which unit of measure is being used.
<b>T</b>	Tare (T) annunciator indicates a push-button tare weight has been acquired and stored in memory.
<b>PT</b>	Preset Tare (PT) annunciator indicates a preset tare weight has been keyed in or entered and stored in memory.
	Wi-Fi annunciator displays at the top right of the display when the Enabled parameter in the WiFi & Bluetooth menu ( <a href="#">Section 4.5.4.4 on page 51</a> ) is set to WiFi or Both.
	Bluetooth® annunciator displays at the top right of the display when the Enabled parameter in the WiFi & Bluetooth menu ( <a href="#">Section 4.5.4.4 on page 51</a> ) is set to Bluetooth or Both.

Table 3-2. Display Status Annunciators

## 3.3 General Navigation






The front panel scale function buttons are also used to navigate through the menu structure.



-  and  move left and right (horizontally) in a menu level
-  and  move up and down to different menu levels
-  enters a menu or parameter and selects/saves highlighted parameter settings or values
-  exits a parameter and selects/saves highlighted parameter settings or values
-  to access *User* mode, to leave a parameter without making changes, or to return to *Weigh* mode
- Use the numeric keypad to enter a value and press  to accept the value ([Section 3.3.1](#))

### 3.3.1 Numeric Value Entry

Several parameters in the menu structure require the entry of a numeric value rather than the making of a selection.





















Follow this procedure to enter a numeric value:

1. Press  or  to enter into a parameter. The current parameter value displays.
2. Press  to clear the current value.
3. Use the numeric keypad to enter a new value.
4. If necessary, press  to toggle the value between negative and positive.
5. Press  to save the new value. The next parameter in the menu displays.

 **NOTE:** Pressing  also saves the new value, but the indicator returns up to the current parameter, rather than to the next parameter in the menu.

### 3.3.2 Alphanumeric Entry

Several parameters in the menu structure require the entry of an alphanumeric value rather than the making of a selection. When these parameters are entered a full keyboard appears on the display. The front panel scale function buttons are used to navigate the keyboard and select alphanumeric options. The softkeys are used to interact with keyboard options.

-  UNITS and  PRINT  move left and right (horizontally) on the keyboard
-  ZERO  and  GROSS NET B/N  move up and down (vertically) on the keyboard
-  TARE  selects the keyboard option that is highlighted and adds it to the alphanumeric string at the top of the display
  - 1# – Changes keyboard view to numbers and special characters
  - abc/ABC – Capitalize or lowercase keyboard letters; also switches keyboard view from numbers back to letters
  -  – Deletes individual digit in the alphanumeric string
  -  – Return key is not used for the 682
-  selects the keyboard option located above the softkey
  -  Cancel – Exits back to menu without saving changes
  -  Save – Save changes and exits back to menu
  -  and  – Moves cursor left and right within the alphanumeric string
  -  – Inserts a space into the alphanumeric string
-  CLEAR deletes the entire alphanumeric string
-  MENU  leaves the parameter without saving the changes

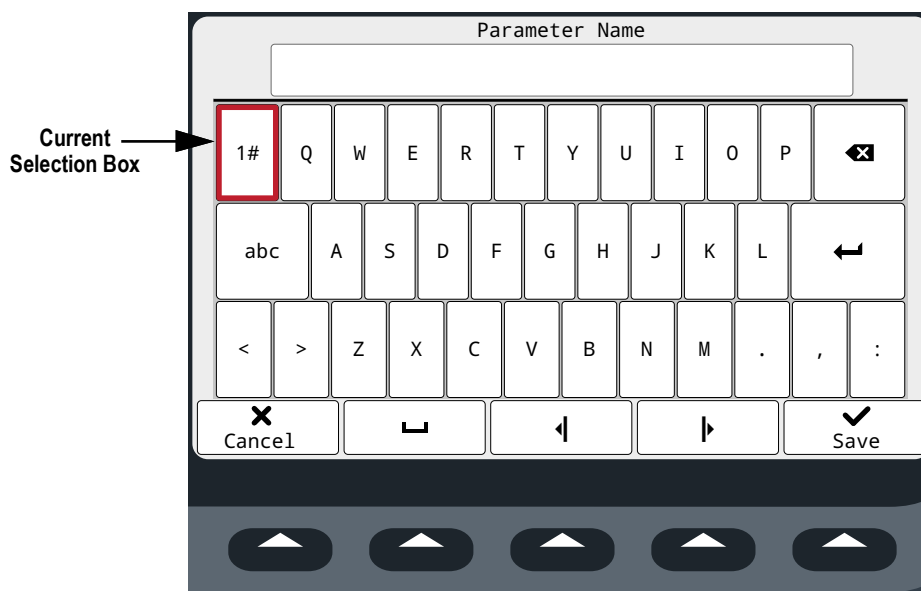





Figure 3-2. Full Keyboard

## 3.4 General Indicator Operation

This section provides procedures for basic 682 operations.



### 3.4.1 Zero Scale




1. In Gross mode, remove all weight from the scale and wait for  to display.
2. Press ,  displays to indicate the scale is zeroed.



**NOTE:** The scale must be stable and within the configured zero range for the scale to be zeroed.

### 3.4.2 Print Ticket


1. Wait for  to display.
2. Press  to send data to the configured port(s). The default print destination is RS-232 Port 1.

If  does not display and  is pressed, the print action only occurs if the scale comes out of motion within three seconds. If the scale stays in motion for over three seconds, the  press is ignored.




**NOTE:** Auxiliary Format 1-4 can be printed using softkeys (Section 3.4.19 on page 38) or by pressing the corresponding format number on the numeric keypad, followed by the PRINT key. For example, to print Auxiliary Format 2, press the 2 key, followed by the PRINT key.

### 3.4.3 Toggle Units



Press  to toggle between primary, secondary and tertiary units, if configured. The current unit displays.

### 3.4.4 Toggle Gross/Net Mode

NET mode is available when a tare value has been entered or acquired (Net = Gross minus Tare). If tare has not been entered or acquired, the display remains in GROSS mode. GROSS or NET is indicated on the left side of the display to indicate the current mode. If a tare has been applied, the current tare weight displays in the lower middle of the weight display area.

Press  to toggle the display mode between GROSS mode and NET mode.



### 3.4.5 Acquire Tare



1. Place a container on the scale and wait for  to display.
2. Press , to acquire the tare weight of the container. The net weight displays and the Net is indicated on the left side of the display. A "T" displays in the lower middle of the weight display area, followed by the current Tare weight.

### 3.4.6 Remove Stored Tare Value

1. Remove all weight from the scale and wait for  to display. The display reads the negative tare value and  displays.




**NOTE:** Press  to zero the scale, if  is not displayed.

2. Press  (or  in OIML mode). Display changes to gross weight and Gross is indicated on the display.



### 3.4.7 Preset Tare (Keyed Tare)





Tare Function (Section 4.5.1 on page 43) must be set to Keyed Tare or Both for the preset tare feature to function.

1. Remove all weight from the scale and wait for  $\nabla \triangle$  and  $\rightarrow 0 \leftarrow$  to display.
2. With the scale displaying zero weight, use the numeric keypad to enter the tare weight value and press .
3. The display changes to net weight and Net is indicated on the display. A “PT” displays in the lower middle of the weight display area, followed by the current Preset Tare weight.



**NOTE:** Press  again while  $\nabla \triangle$  displays, or enter a keyed tare of zero to remove the preset tare value.









### 3.4.8 Display a Stored Tare

1. Press . Audit displays.
2. Press  or  until Tare displays.
3. Press . Display Tare displays.
4. Press . The stored tare value displays.
5. Press  twice to return to Weigh mode.











**NOTE:** If there is not a tare in the system, the value displayed is zero.

### 3.4.9 Clear a Stored Tare





1. Press . Audit displays.
2. Press  or  until Tare displays.
3. Press . Display Tare displays.
4. Press . Clear Tare displays.
5. Press  or  to clear the stored tare value. OK displays.
6. Press  twice to return to Weigh mode.

### 3.4.10 View Audit Trail Counters









The audit trail calibration and configuration counters can be viewed in *User* mode.

1. Press . Audit displays.
2. Press . Legally Relevant Version displays.
3. Press . Calibration Counter displays.
4. Press . The audit trail calibration counter number displays.
5. Press . Calibration Counter displays.
6. Press . Configuration Counter displays.
7. Press . The audit trail configuration counter number displays.
8. Press  twice to return to Weigh mode.











### 3.4.11 View Legally Relevant Version

1. Press . Audit displays.
2. Press . Legally Relevant Version displays.
3. Press . The current version number displays.
4. Press  twice to return to *Weigh* mode.











### 3.4.12 Display Accumulator

1. Press . Audit displays.
2. Press . User displays.
3. Press . Setpoint displays.
4. Press  or  until Accumulator displays.
5. Press . Display Accumulator displays.
6. Press . The accumulator value displays.
7. Press  twice to return to *Weigh* mode.

### 3.4.13 Print Accumulator







1. Press . Audit displays.
2. Press . User displays.
3. Press . Setpoint displays.
4. Press  or  until Accumulator displays.
5. Press . Display Accumulator displays.
6. Press . Print Accumulator displays.
7. Press  or  to print the accumulator value. OK displays.
8. Press  twice to return to *Weigh* mode.

### 3.4.14 Clear Accumulator

1. Press . Audit displays.
2. Press . User displays.
3. Press . Setpoint displays.
4. Press  or  until Accumulator displays.
5. Press . Display Accumulator displays.
6. Press . Clear Accumulator displays.
7. Press  or  to clear the accumulator value. OK displays.
8. Press  twice to return to *Weigh* mode.

### 3.4.15 View and Edit Time Value

To view and edit the current time:

1. Press . Audit displays.
2. Press . User displays.
3. Press . Setpoint displays.
4. Press  or  until Time displays.
5. Press  to view the current set time.

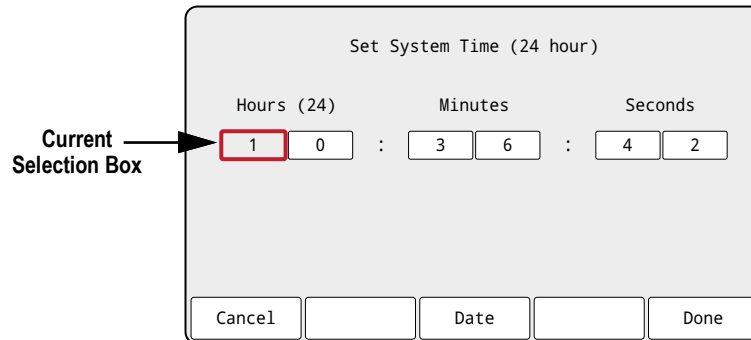







Figure 3-3. Set System Time

6. To edit the time value use the following method:
  -  and  to move left and right through the time settings
  -  and  to edit the currently highlighted time setting number
  - Use available softkeys:
    - Cancel – Exit without saving
    - Date – Switch to view date value
    - Done – Save and exit time value
7. Once back to the menu, press  to return to *Weigh* mode.



**NOTE:** Time is backed up by the internal battery and is not lost if the main power is interrupted. See [Section 4.5.5 on page 53](#) for time formatting options.

### 3.4.16 View and Edit Date Value

To view and edit the current date:

1. Press . Audit displays.
2. Press . User displays.
3. Press . Setpoint displays.
4. Press or until Date displays.
5. Press to view the current set date.

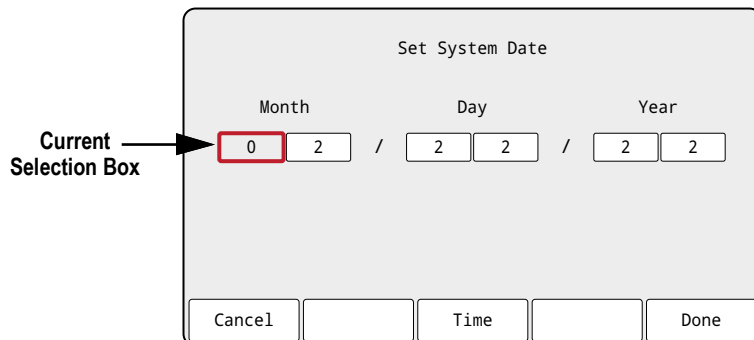


Figure 3-4. Set System Date











6. To edit the date value use the following method:
  - and to move left and right through the date settings
  - and to edit the currently highlighted date setting number
  - Use available softkeys:
    - Cancel – Exit without saving
    - Time – Switch to view time value
    - Done – Save and exit date value
7. Once back to the menu, press to return to *Weigh* mode.



**NOTE:** Date is backed up by the internal battery and is not lost if the main power is interrupted. See [Section 4.5.5 on page 53](#) for date formatting options.







### 3.4.17 Ethernet, Wi-Fi and Bluetooth® MAC IDs

The Ethernet MAC ID, Wi-Fi MAC ID and Bluetooth® MAC ID can be viewed through the top-level menu ([Section 4.2 on page 41](#)). MAC addresses display in the following format: 88:88:88:88:88:88.

1. Press . Audit displays.
2. Press  or  until MAC ID displays.
3. Press . Ethernet MAC ID displays.
4. Press  to view the Ethernet MAC ID.
5. Press . WiFi MAC ID displays.
6. Press  to view the Wi-Fi MAC ID.
7. Press . Bluetooth MAC ID displays.
8. Press  to view the Bluetooth® MAC ID.
9. Press  twice to return to *Weigh* mode.



### 3.4.18 View Configured Setpoint Values

See [Section 14.0 on page 116](#) more information.

1. Press . Audit displays.
2. Press . User displays.
3. Press . Setpoint displays.
4. Press . The lowest configured setpoint number displays (e.g. Setpoint 1).
5. Press  or  to navigate to the desired setpoint number (1-8).






**NOTE:** Only configured setpoint numbers display. See [Section 4.5.8 on page 59](#) for the complete setpoint menu.

6. Press . Value displays.
7. Press  again to view the current configured setpoint value.














**NOTE:** Displayed setpoints are editable by default, since Access defaults to On. Change Access settings if Setpoint value needs to be read only (Access = Off) or hidden (Access = Hidden).


8. To edit the setpoint value use the following method:
  - Press  to clear the current value
  - Use the numeric keypad to enter the new value
  - Press  to accept the new value once correct
9. Press  to return to *Weigh* mode.

### 3.4.19 Configure Softkeys

Up to 15 softkeys can be configured to perform a variety of functions. See [Section 4.5.11 on page 64](#) for softkey configuration and softkey descriptions. Configuring softkeys requires access to *Setup* mode ([Section 4.1 on page 40](#)).

1. Navigate to the Configuration menu within the Setup menu. Configuration displays.
2. Press  or  until Softkey displays.
3. Press . Assigned Softkey displays.
4. Press . Softkey 1 displays.
5. Press  or  to navigate to the desired softkey number (1-15).
6. Press . The current softkey setting is highlighted.
7. Press  or  to navigate to the desired softkey setting, if necessary.
8. Press  to accept the highlighted softkey setting.
9. Repeat steps for all needed softkeys.

 **NOTE:** If 6 or more softkeys are enabled, left and right arrows appear in the outside softkey locations to allow navigation between available softkeys.

10. Press  to return to *Weigh* mode.

### 3.4.20 Alibi Storage

Alibi storage is a database of past print transactions listed by date. It allows previous print transactions to be recalled and reprinted. Alibi storage is enabled in the Program menu ([Section 4.5.5 on page 53](#)) while the indicator is in *Setup* mode. Print transactions can be viewed from the front panel of the 682 by configuring a softkey ([Section 3.4.19](#)) to Alibi. Pressing the Alibi softkey displays the Alibi Storage screen.

Alibi storage is saved in the board's flash memory (no external memory is required) and data is validated with a cyclic redundancy check (CRC). There is space for 128 KB of data or 2000 print transactions. If the space limit is hit, the first 4 KB of print transactions are deleted to free up space.

Alibi Storage				
0	:	02:23 PM 03/24/22	GROSS	1015 lb
1	:	08:37 AM 03/26/22	GROSS	3210 lb
2	:	12:46 PM 03/28/22	GROSS	4535 lb
3	:	10:12 AM 04/01/22	GROSS	980 lb
4	:	03:21 PM 04/01/22	GROSS	2255 lb

Current Selection Box →

Page Up	Page Down	Reprint	Purge Oldest	Cancel
---------	-----------	---------	--------------	--------









Figure 3-5. Alibi Storage Screen

#### Alibi Storage Softkeys

- Page Up – Returns to the previous five print transactions
- Page Down – Advances to the next five print transactions
- Reprint – Prints the selected print transaction
- Purge Oldest – Deletes the oldest 4 KB of print transactions
- Cancel – Exits the Alibi Storage screen and returns to *Weigh* mode

### 3.4.21 Enter New Unit ID













Entering a new Unit ID requires access to *Setup* mode ([Section 4.1 on page 40](#)).

1. Navigate to the Configuration menu within the Setup menu. *Configuration* displays.
2. Press  or  until *Program* displays.
3. Press . *Power Up Mode* displays.
4. Press  or  until *Unit ID* displays.
5. Press . The current unit ID value displays with the on-screen keyboard.
6. Edit the value using the alphanumeric entry procedure ([Section 3.3.2 on page 31](#)).
7. Press  to exit without saving.  
- Or -  
Press  to save and exit when the value is correct.

Once back to the menu, press  to return to *Weigh* mode.







### 3.4.22 Passwords

The User and Setup menus and can be password protected. See [Section 1.4 on page 10](#) for a description of the *User* and *Setup* modes and what menus are included in each. Use the follow procedure to configure passwords:

1. Navigate to the Configuration menu within the Setup menu. *Configuration* displays.
2. Press  or  until *Program* displays.
3. Press . *Power Up Mode* displays.
4. Press  or  until *Password* displays.
5. Press . *User* displays.
6. Press  or  to navigate to the desired password.
7. Press . The current password displays with the on-screen keyboard.
8. Edit the value using the alphanumeric entry procedure ([Section 3.3.2 on page 31](#)).
9. Press  to exit without saving.  
- Or -  
Press  to save and exit when the value is correct.
10. Once back to the menu, press  to return to *Weigh* mode.

### 3.4.23 Reset Configuration

Defaulting the 682 configuration requires access to *Setup* mode ([Section 4.1 on page 40](#)).

1. Navigate to the Configuration menu within the Setup menu. *Configuration* displays.
2. Press . *Default Configuration* displays.
3. Press . *No* displays.
4. Press . *Yes* displays.
5. Press  or  to reset the configuration setting. *OK* displays.
6. Press  twice to return to *Weigh* mode.

## 4.0 Configuration

There are two types of configuration parameters in the 682, *Setup* mode parameters (or Legal for Trade configuration) and *User* mode parameters (or non-legal configuration). *Setup* mode parameters are accessed by pressing the setup switch (Section 4.1). *User* mode parameters are accessed by pressing the menu button and do not require pressing the setup switch. Some *User* mode parameters can be password protected (Section 3.4.22 on page 39).

The following sections provide graphic representations of the 682 menu structures. Most menu diagrams are accompanied by a table which describes all parameters and parameter values associated with the menu. The factory default setting appears at the top of each column in bold type.

The Audit, User, Tare, MAC ID, Fieldbus Version and Version menus can be accessed by pressing the MENU button. The Audit, Tare, MAC ID, Fieldbus Version and Version menus are read only. The Setpoint (limited), Accumulator, Time and Date menus are available in the User menu and can be password protected (Section 3.4.22 on page 39).


 **NOTE:** The *User mode setpoints menu displays the setpoint value of configured setpoints and is accessible with the menu button. Complete configuration of setpoints is available in Setup mode within the Setup menu.*

The Setup menu is accessed by pressing the setup switch (Section 4.1) and can also be password protected.

 **NOTE:** All weight related parameters must be configured prior to calibrating the unit.

### 4.1 Setup Switch

In order to configure the 682, it must be placed in *Setup* mode with the setup switch or with the audit jumper (Section 4.1.1). The setup switch is accessed through a small hole on the bottom of the enclosure. Remove the setup switch screw and insert a non-conductive tool into the access hole to press the setup switch.

 **IMPORTANT:** Use caution when inserting the non-conductive tool into the enclosure. Insert the tool about 3/4 in (19 mm), until the switch is engaged. Do not use excessive force which could damage the switch.

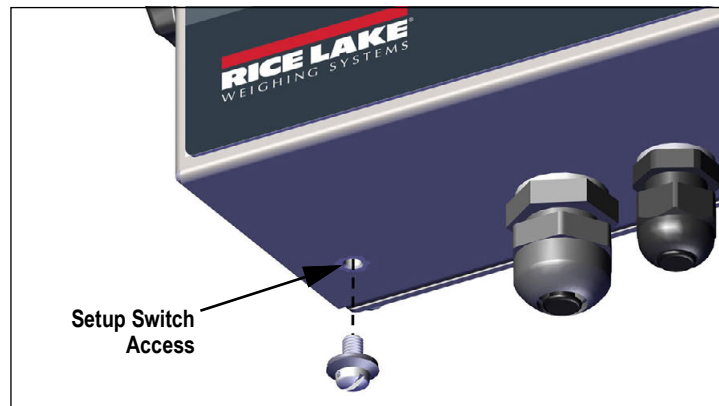



Figure 4-1. Setup Switch Access

When the 682 is placed in *Setup* mode, the Setup menu is accessed and Configuration displays. See Section 4.5 on page 43 for a detailed breakdown of this menu. Torque the setup switch screw to 10 in-lb (1.1 N-m) when reinserting.

#### 4.1.1 Audit Jumper

The audit jumper (J24) turns *Setup* mode access through the menu ON and OFF. Access to *Setup* mode is allowed without pressing the setup switch when the audit jumper is in the ON position. Access to *Setup* mode requires pressing the setup switch when the audit jumper is in the OFF position. See Section 2.6 on page 22 for the location of the audit jumper on the CPU board.

 **NOTE:** In certain Legal for Trade applications it is necessary to seal the indicator to restrict access to the setup switch (Section 2.8 on page 24). Breaking of the seal terminates the Legal for Trade status of the indicator.



## 4.2 Main Menu

This section provides a flow chart and descriptions for the 682 top-level Main menu.

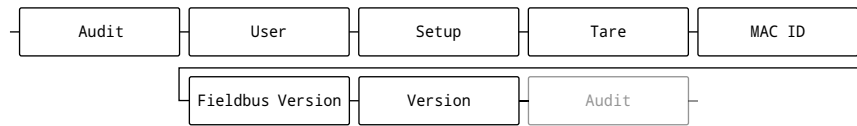


Figure 4-2. Main Menu

Menu	Description
Audit	Displays the legally relevant firmware version and allows access to view/print audit trail information; see <a href="#">Section 4.3</a>
User	See <a href="#">Section 4.4 on page 42</a> for menu structure and parameter descriptions of the User menu
Setup	See <a href="#">Section 4.5 on page 43</a> for menu structure and parameter descriptions of the Setup menu; only accessible by pressing the setup switch, or through the menu if the audit jumper is in the ON position
Tare	Displays and clears stored tare value; see <a href="#">Section on page 65</a>
MAC ID	Displays the MAC addresses for Ethernet, Wi-Fi and Bluetooth® (read only)
Fieldbus Version	Displays the connected Fieldbus module's firmware version (read only); displays V0.00.00 if no Fieldbus module is connected
Version	Displays the installed firmware version number (read only)

Table 4-1. Main Menu Descriptions

## 4.3 Audit Menu

This section provides a flow chart and descriptions for the Audit menu.

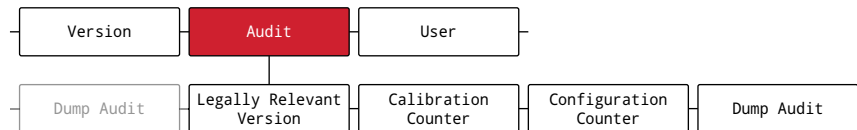


Figure 4-3. Audit Menu

Parameter	Description
Legally Relevant Version	Legally relevant firmware version number (read only)
Calibration Counter	Displays total number of calibration events (read only)
Configuration Counter	Displays total number of configuration events (read only)
Dump Audit	Sends the audit parameters to the configured audit destination ports ( <a href="#">Section 4.5.6 on page 56</a> )

Table 4-2. Audit Menu Descriptions

## 4.4 User Menu

This section provides a flow chart and descriptions for the User menu. The User menu and can be password protected. See [Section 3.4.22 on page 39](#) for the procedure to set a User menu password.

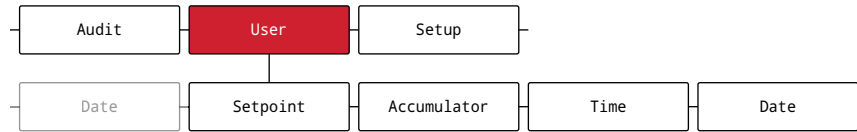


Figure 4-4. User Menu

Parameter	Description
Setpoint	Displays the setpoint value of configured setpoints; read only unless access parameter for the setpoint is set to ON; Setpoint menu is empty if no setpoints are configured; setpoints are fully configurable in the setup menu while the indicator is in <i>Setup</i> mode
Accumulator	Displays, prints and clears accumulated weight value; see <a href="#">Section 4.4.1</a>
Time	Displays the current set time; allows the time to be edited (24-hour) using the navigation keys and softkeys; see <a href="#">Section 3.4.15 on page 35</a> for editing procedure
Date	Displays the current set date; allows the date to be edited using the navigation keys and softkeys; see <a href="#">Section 3.4.16 on page 36</a> for editing procedure

Table 4-3. User Menu Descriptions

### 4.4.1 Accumulator Menu

This section provides a flow chart and descriptions for the Accumulator menu.

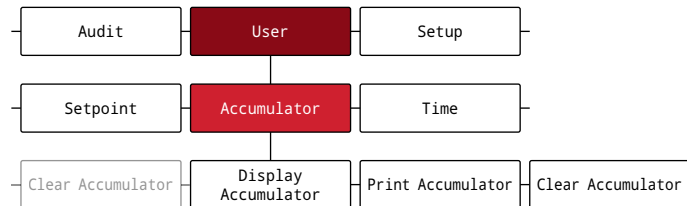


Figure 4-5. Accumulator Menu

Parameter	Description
Display Accumulator	Displays the accumulator value (read only)
Print Accumulator	Prints the accumulator value using the Accumulator Format (ACCFMT) print format to the specified port(s)
Clear Accumulator	Clears the accumulator value

Table 4-4. Accumulator Menu Parameters

## 4.5 Setup Menu

This section provides a flow chart and descriptions for the Setup menu. The Setup menu and can be password protected. See [Section 3.4.22 on page 39](#) for the procedure to set a Setup menu password.

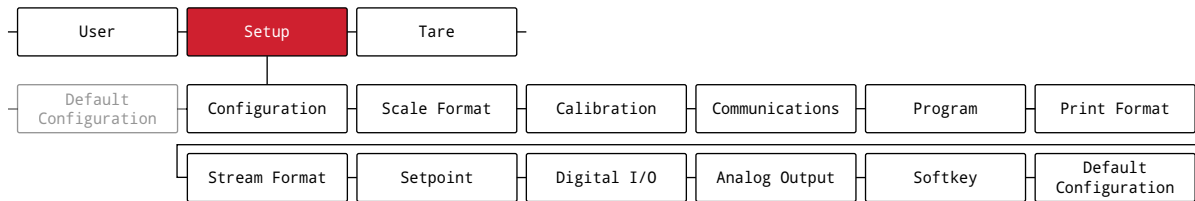


Figure 4-6. Setup Menu

Menu	Description
Configuration	See <a href="#">Section 4.5.1</a> for menu structure and parameter descriptions of the Configuration menu
Scale Format	See <a href="#">Section 4.5.2 on page 45</a> for menu structure and parameter descriptions of the Scale Format menu
Calibration	See <a href="#">Section 4.5.3 on page 46</a> for menu structure and parameter descriptions of the Calibration menu
Communications	See <a href="#">Section 4.5.4 on page 47</a> for menu structure and parameter descriptions of the Communications menu
Program	See <a href="#">Section 4.5.5 on page 53</a> for menu structure and parameter descriptions of the Program menu
Print Format	See <a href="#">Section 4.5.6 on page 56</a> for menu structure and parameter descriptions of the Print Format menu
Stream Format	See <a href="#">Section 4.5.7 on page 58</a> for menu structure and parameter descriptions of the Stream Format menu
Setpoint	See <a href="#">Section 4.5.8 on page 59</a> for menu structure and parameter descriptions of the Setpoint menu
Digital I/O	See <a href="#">Section 4.5.9 on page 63</a> for menu structure and parameter descriptions of the Digital I/O menu
Analog Output	See <a href="#">Section 4.5.10 on page 63</a> for menu structure and parameter descriptions of the Analog Output menu
Softkey	See <a href="#">Section 4.5.11 on page 64</a> for menu structure and parameter descriptions of the Softkey menu
Default Configuration	See <a href="#">Section 3.4.23 on page 39</a> for instructions to reset the configuration settings

Table 4-5. Setup Menu Descriptions

### 4.5.1 Configuration Menu

This section provides a flow chart and descriptions for the Configuration menu.

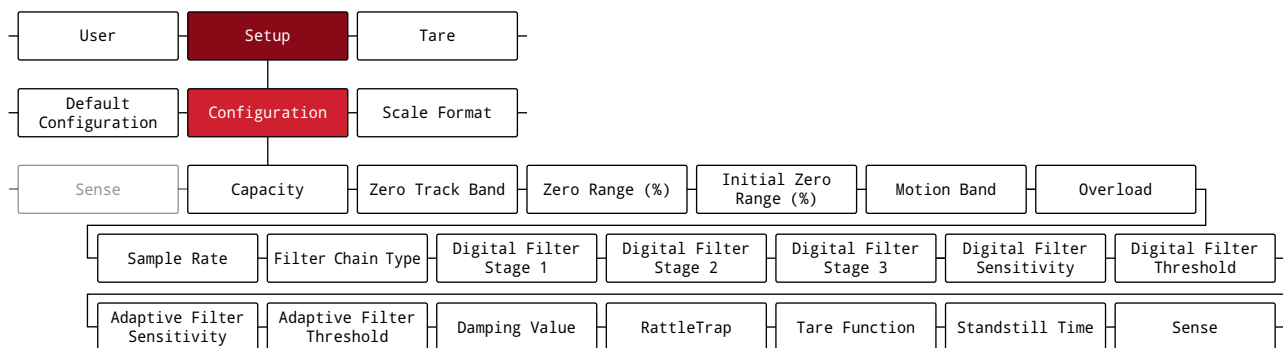


Figure 4-7. Configuration Menu

Menu	Description
Capacity	Maximum rated capacity of the scale; <i>Enter value: 0.0000001–9999999.0, 10000.0 (default)</i>
Zero Track Band	Automatically zeros the scale when within the range specified, as long as the input is within the Zero Range (%) and scale is at standstill; When weight is within the zero band, the center of zero annunciator displays; Max legal value depends on local regulations; Specify the zero tracking band in $\pm$ display divisions; <i>Enter value: 0.0–100.0, 0.0 (default)</i>
Zero Range (%)	The total amount the scale can be zeroed; Zero range represents a percentage of capacity; The default value of 1.9 represents $\pm 1.9\%$ around the calibrated zero point, for a total range of 3.8%; A value of 0.0 prevents zeroing; Maximum legal value depends on local regulations; <i>Enter value: 0.0–100.0, 1.9 (default)</i>

Table 4-6. Configuration Menu Descriptions

Menu	Description
Initial Zero Range (%)	When the indicator is turned on and the weight value is between the $\pm$ percent range specified by Calibrated Zero, the indicator automatically zeros off the weight; <i>Enter value: 0.0–100.0, 0.0 (default)</i>
Motion Band	Sets the level, in display divisions, at which scale motion is detected; If motion is not detected for the time defined by Standstill Time, the standstill symbol lights; Some operations, including print, tare and zero, require the scale to be at standstill; Maximum legal value varies depending on local regulations; If this parameter is set to 0, the standstill annunciator is always lit and operations requiring standstill are performed regardless of scale motion; If 0 is selected, Zero Track Band must also be set to 0; <i>Enter value: 0–100, 1 (default)</i>
Overload	Determines the point at which the display blanks and the overload error message displays (^^^^^^); Maximum legal value varies depending on local regulations; <i>Settings: Full Scale + 2% (default), Full Scale + 1D, Full Scale + 9D, Full Scale</i>
Sample Rate	Selects measurement rate, in samples per second, of the analog-to-digital converter; Lower sample rate values provide greater signal noise immunity; <i>Settings: 6.25HZ, 7.5HZ, 12.5HZ, 15HZ, 25HZ, 30HZ (default), 50HZ, 60HZ, 100HZ, 120HZ</i>
Filter Chain Type	Sets the filter type to be used; <i>Settings:</i> <b>Average Only</b> (default) – Digital Rolling Average Filter ( <a href="#">Section 16.7.1 on page 131</a> ); Uses Digital Filter Stage 1-3, Digital Filter Sensitivity and Digital Filter Threshold <b>Adaptive Only</b> – Adaptive Filter ( <a href="#">Section 16.7.2 on page 132</a> ); Uses Adaptive Filter Sensitivity and Adaptive Filter Threshold <b>Damping Only</b> – Damping Filter ( <a href="#">Section 16.7.3 on page 133</a> ); Uses Damping Value <b>Raw</b> – No filtering
Digital Filter Stage 1-3	Sets the digital filtering rate used to reduce the effects of environmental influences from the immediate area of the scale; Settings indicate the number of A/D conversions per update which are averaged to obtain the displayed reading; a higher number gives a more accurate display by minimizing the effect of a few noisy readings, but slows down the response time of the indicator; <i>Settings: 1, 2, 4 (default), 8, 16, 32, 64, 128, 256</i>
Digital Filter Sensitivity	Specifies the number of consecutive A/D readings which fall outside the Filter Threshold before filtering is suspended; <i>Settings: 20OUT (default), 40OUT, 80OUT, 160OUT, 320OUT, 640OUT, 1280OUT</i>
Digital Filter Threshold	Sets a threshold value, in display divisions; when a number of consecutive A/D readings (Digital Filter Sensitivity) falls outside of this threshold value (when compared to the output of the filter), filtering is suspended and the A/D value is sent straight through the filter; Filtering is not suspended if the threshold is set to NONE; <i>Settings: NONE (default), 2D, 5D, 10D, 20D, 50D, 100D, 200D, 250D</i>
Adaptive Filter Sensitivity	Controls the stability and response time of the scale; <i>Settings:</i> <b>Light</b> (default) – Fastest response to small weight changes, but less stable <b>Medium</b> – Has a quicker response time than heavy, but more stable than light <b>Heavy</b> – Results in an output which is more stable but settles slowly; small changes in weight data (a few grads) on the scale base are not seen quickly
Adaptive Filter Threshold	Sets the adaptive filter weight threshold value (in display divisions); a weight change exceeding the threshold resets the filtered values; must be set above the noise disturbances in the system (if set to zero, the filter is disabled); <i>Enter value: 0–2000, 10 (default)</i>
Damping Value	Sets the damping time constant (in 0.1 sec intervals); <i>Enter value: 1–2560, 10 (default)</i>
RattleTrap	Enables RattleTrap filtering; Effective at eliminating vibration effects, environmental influences and mechanical interference from nearby machinery, may increase response time over standard digital filtering; <i>Settings: Off (default), On</i>
Tare Function	Enables or disables push-button and keyed tare; <i>Settings:</i> <b>Both</b> (default) – Both push button and keyed tares are enabled <b>No Tare</b> – No tare allowed (gross mode only) <b>Push Button Tare</b> – Push button tares enabled <b>Keyed Tare</b> – Keyed tares enabled
Standstill Time	Specifies the length of time the scale must be out of motion, before the scale is considered to be at standstill (in 0.1 sec intervals); <i>Enter value: 0–600, 10 (default)</i>
Sense	Specifies the type of load cell cable connected to the J1 connector ( <a href="#">Section 2.5.5 on page 18</a> ); this parameter must be set correctly to match the actual load cell cable connection to ensure the load cell functions properly with the indicator; <i>Settings: 4-WIRE (default), 6-WIRE</i>

Table 4-6. Configuration Menu Descriptions (Continued)

### 4.5.2 Scale Format Menu

This section provides a flow chart and descriptions for the Scale Format menu.

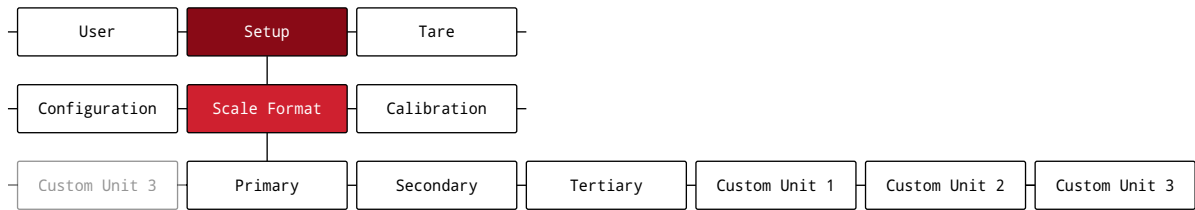


Figure 4-8. Scale Format Menu

Parameter	Description
Primary	<p>Scale format and units settings for the Primary format; Sub-Parameters:</p> <p>Format – Sets the decimal point and the display divisions for the Primary display weight format;  <i>Settings: 8888881 (Primary default), 8888882, 8888885, 8888810, 8888820, 8888850, 8888100, 8888200, 8888500, 88.88881, 88.88882, 88.88885, 888.8881, 888.8882, 888.8885, 8888.881, 8888.882, 8888.885, 8888.881, 8888.882, 8888.885, 88888.81, 88888.82, 88888.85, 88888.1, 88888.2, 88888.5</i></p> <p>For example, select 8888.885 if a count by of 0.005 is needed or select 8888820 if a count by of 20 is needed (the 8s serve as placeholders and show a breakdown of how digits will display);</p> <p>Units – Sets the units type; <i>Settings: LB (Primary default), KG, OZ, TN, T, G, NONE</i></p> <p>Split Mode – See <a href="#">Section 5.0 on page 66</a> for more information; Only displays under Primary;  <i>Settings: Off (default), Multi-Range, Multi-Interval</i></p>
Secondary and Tertiary	<p>Scale format and units settings for the Secondary and Tertiary format; Sub-Parameters:</p> <p>Format – Sets the decimal point and the display divisions for the Secondary and Tertiary display weight format;  <i>Settings: 8888881, 8888882, 8888885, 8888810, 8888820, 8888850, 8888100, 8888200, 8888500, 88.88881, 88.88882, 88.88885, 888.8881, 888.8882, 888.8885, 8888.881, 8888.882, 8888.885, 88888.81, 88888.82, 88888.85, 88888.1, 88888.2, 88888.5 (Secondary and Tertiary default)</i></p> <p>For example, select 8888.885 if a count by of 0.005 is needed or select 8888820 if a count by of 20 is needed (the 8s serve as placeholders and show a breakdown of how digits will display);</p> <p>Units – Sets the units type; <i>Settings: LB, KG (Secondary and Tertiary default), OZ, TN, T, G, NONE</i></p> <p>Enabled – Enables the front panel UNITS button to toggle between the Primary, Secondary and Tertiary formats; Only displays under Secondary and Tertiary; <i>Settings: ON (Secondary default), OFF (Tertiary default)</i></p>
Custom Unit 1-3	<p>Available custom units that can be set as the Secondary and Tertiary units to convert weight of the Primary unit; Sub-Parameters:</p> <p>Label – Available to enter a name for custom units; maximum length is 2 alphanumeric characters; blank by default</p> <p>Multiplier – Conversion factor/multiplier applied to the primary units to convert weight for custom units; <b>1.0</b> (default)  <i>For example, to configure a custom unit to gallons (with primary units set to lb), set the custom unit multiplier to 8</i></p>

Table 4-7. Scale Format Menu Parameters

### 4.5.3 Calibration Menu

This section provides a flow chart and descriptions for the Calibration menu.

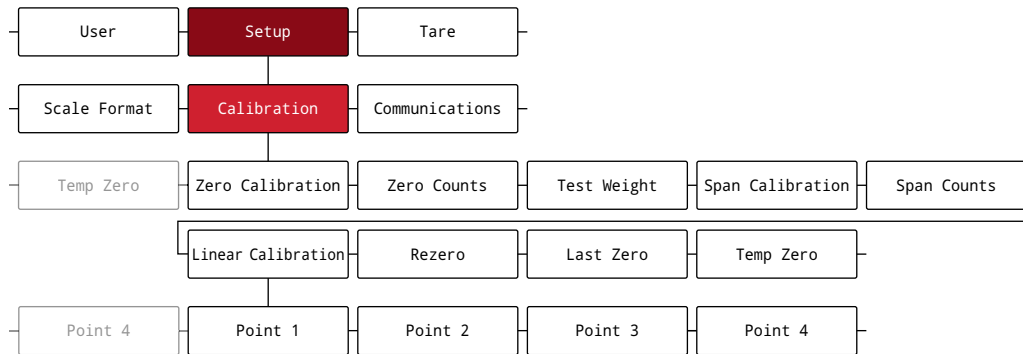


Figure 4-9. Calibration Menu

Parameter	Description
Zero Calibration	Executes the zero calibration process ( <a href="#">Section 6.1 on page 68</a> )
Zero Counts	Displays the raw count value at the zero weight; A zero calibration generates this raw count value; Manually changing this count value changes the zero weight and negates the zero calibration
Test Weight	Sets the test weight value for the span calibration ( <a href="#">Section 6.1 on page 68</a> ); Enter value: 0.000001–9999999.999999, <b>10000.0</b> (default)
Span Calibration	Executes the span calibration process ( <a href="#">Section 6.1.1 on page 68</a> )
Span Counts	Displays the raw count value at the span weight; A span calibration generates this raw count value; Manually changing this count value changes the span weight and negates the span calibration
Linear Calibration	Linear or multi-point calibration is performed by entering up to four additional calibration points ( <a href="#">Section 6.1.2 on page 69</a> ); Points 1-4 have the following sub-parameters: Linear Point # Weight – Sets the test weight value for the linear calibration point Calibrate Linear Point # – Executes the linear calibration process for the point; generates the raw count value for the test weight value for Point # Linear Point # Counts – Displays the raw count value at the linear point weight; A linear calibration generates this raw count value; Manually changing this count value changes the linear point weight and negates the linear calibration for the point
Rezero	Removes an offset value from the zero and span calibrations ( <a href="#">Section 6.2.3 on page 69</a> )
Last Zero	Takes last push button zero in the system (from <i>Weigh</i> mode) and uses it as the new zero reference point, after which a new span calibration must be performed; this calibration cannot be performed when calibrating a scale for the first time ( <a href="#">Section 6.2.1 on page 69</a> )
Temp Zero	Temporarily zeros the displayed weight of a non-empty scale, after a span calibration was performed; The difference between the temporary zero and the previously calibrated zero value is used as an offset ( <a href="#">Section 6.2.2 on page 69</a> )

Table 4-8. Calibration Menu Parameter

### 4.5.4 Communications Menu

This section provides a flow chart and descriptions for the Communications menu.

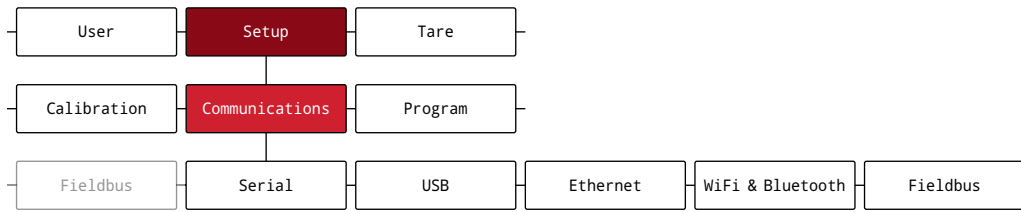


Figure 4-10. Communications Menu

Menu	Description
Serial	Supports RS-232 and RS-485/422 serial communications (Section 4.5.4.1)
USB	Intended to be connected to a PC only; appears as a Virtual COM Port and is assigned a "COMx" designation; Applications communicate through the port like a standard RS-232 communications port (Section 4.5.4.2 on page 49)
Ethernet	Features Ethernet TCP/IP 10Base-T/100Base-TX communication and can support two simultaneous connections, one as a server, the other as a client (Section 4.5.4.3 on page 50)
WiFi & Bluetooth	Supports Wi-Fi and Bluetooth® communications (Section 4.5.4.4 on page 51)
Fieldbus	Supports Fieldbus network protocol communications if Fieldbus module is connected (Section 4.5.4.5 on page 52)

Table 4-9. Communications Menu Descriptions

#### 4.5.4.1 Serial Menu

This section provides a flow chart and descriptions for the Serial menu.

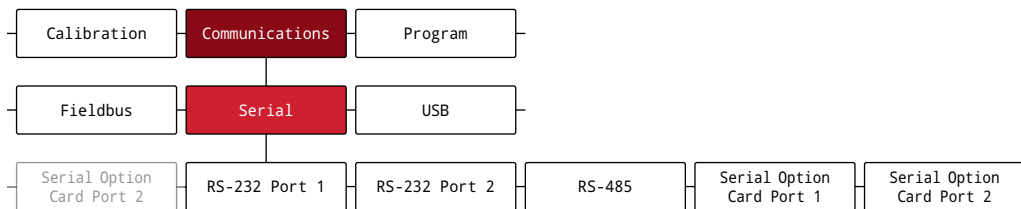


Figure 4-11. Serial Menu

Parameter	Description
RS-232 Port 1-2	<p>Configurable parameters for RS-232 serial communications ports; Sub-Parameters:</p> <ul style="list-style-type: none"> <li>Trigger – Sets the input trigger type; <i>Settings:</i> <ul style="list-style-type: none"> <li><b>Command</b> (default) – Allows operation of EDP commands and printing</li> <li><b>Stream Industrial</b> – Scale data is updated up to configured sample rate; Allows operation of EDP commands and printing</li> <li><b>Stream Legal for Trade</b> – Scale data is updated at configured display update rate; Allows operation of EDP commands and printing</li> <li><b>Remote</b> – Configures the port to operate as a serial scale input</li> </ul> </li> </ul> <p><b>NOTE: When in STRIND, STRLFT or REMOTE, if the COMM port is set to RS485, the port does not stream data.</b></p> <ul style="list-style-type: none"> <li>Baud – Sets the transmission speed for the port; <i>Settings:</i> 1200, 2400, 4800, <b>9600</b> (default), 19200, 28800, 38400, 57600, 115200</li> <li>Bits – Sets number of data bits transmitted or received by the port and specifies the parity bit to odd, even or none; <i>Settings:</i> <b>8NONE</b> (default), 8EVEN, 8ODD, 7EVEN, 7ODD</li> <li>Stop Bits – Sets the number of stop bits transmitted or received by the port; <i>Settings:</i> <b>1</b> (default), 2</li> <li>Line Terminator – Sets the termination character for data sent from the port; <i>Settings:</i> <b>CR/LF</b> (default), CR</li> <li>End of Line Delay – Sets the delay period from when a formatted line is terminated to the beginning of the next formatted serial output (0.1-second intervals); <i>Enter value:</i> 0–255, <b>0</b> (default)</li> <li>Echo – Specifies if characters received by the port are echoed back to the sending unit; <i>Settings:</i> <b>On</b> (default), Off</li> <li>Response – Specifies if the port transmits replies to serial commands; <i>Settings:</i> <b>On</b> (default), Off</li> </ul>

Table 4-10. Serial Menu Parameters

Parameter	Description
RS-485	<p>Configurable parameters for RS-485/422 serial communications port; Sub-Parameters:</p> <p>Trigger – Sets the input trigger type; <i>Settings:</i></p> <p><b>Command</b> (<i>default</i>) – Allows operation of EDP commands and printing</p> <p><i>Stream Industrial</i> – Scale data is updated up to configured sample rate; Allows operation of EDP commands and printing</p> <p><i>Stream Legal for Trade</i> – Scale data is updated at configured display update rate; Allows operation of EDP commands and printing</p> <p><i>Remote</i> – Configures the port to operate as a serial scale input</p> <p><i>Fieldbus</i> – Configures the port to operate for Fieldbus; Automatically configures all port parameters for Fieldbus and hides the port parameters in the menu</p> <p><b>NOTE: When in Stream Industrial (STRIND), Stream Legal for Trade (STRLFT) and REMOTE, the port only streams data if the Address is set to 0 (RS-422 mode).</b></p> <p>Baud – Sets the transmission speed for the port; <i>Settings:</i> 1200, 2400, 4800, <b>9600</b> (<i>default</i>), 19200, 28800, 38400, 57600, 115200</p> <p>Bits – Sets number of data bits transmitted or received by the port and specifies the parity bit to odd, even or none; <i>Settings:</i> <b>8NONE</b> (<i>default</i>), 8EVEN, 8ODD, 7EVEN, 7ODD</p> <p>Stop Bits – Sets the number of stop bits transmitted or received by the port; <i>Settings:</i> <b>1</b> (<i>default</i>), 2</p> <p>Line Terminator – Sets the termination character for data sent from the port; <i>Settings:</i> <b>CR/LF</b> (<i>default</i>), CR</p> <p>End of Line Delay – Sets the delay period from when a formatted line is terminated to the beginning of the next formatted serial output (0.1-second intervals); <i>Enter value:</i> 0–255, <b>0</b> (<i>default</i>)</p> <p>Echo – Specifies if characters received by the port are echoed back to the sending unit; <i>Settings:</i> <b>On</b> (<i>default</i>), Off</p> <p>Response – Specifies if the port transmits replies to serial commands; <i>Settings:</i> <b>On</b> (<i>default</i>), Off</p> <p>Address – Specifies address used to connect to the port; Must be set to 0 for RS-422; <i>Enter value:</i> 0–255, <b>0</b> (<i>default</i>)</p> <p>Duplex – Specifies FULL (4-wire) or HALF (2-wire) duplex used to connect to the port; <i>Settings:</i> <b>FULL</b> (<i>default</i>), HALF</p>
Serial Option Card Port 1-2	<p>Configurable parameters for the serial option card ports; Sub-Parameters:</p> <p>Port Type – Sets the serial port type; <i>Settings:</i> <b>RS-232</b> (<i>default</i>), RS-485</p> <p>Trigger – Sets the input trigger type; <i>Settings:</i></p> <p><b>Command</b> (<i>default</i>) – Allows operation of EDP commands and printing</p> <p><i>Stream Industrial</i> – Scale data is updated up to configured sample rate; Allows operation of EDP commands and printing</p> <p><i>Stream Legal for Trade</i> – Scale data is updated at configured display update rate; Allows operation of EDP commands and printing</p> <p><i>Remote</i> – Configures the port to operate as a serial scale input</p> <p><i>Fieldbus</i> – Configures the port to operate for Fieldbus; Automatically configures all port parameters for Fieldbus and hides the port parameters in the menu</p> <p>Baud – Sets the transmission speed for the port; <i>Settings:</i> 1200, 2400, 4800, <b>9600</b> (<i>default</i>), 19200, 28800, 38400, 57600, 115200</p> <p>Bits – Sets number of data bits transmitted or received by the port and specifies the parity bit to odd, even or none; <i>Settings:</i> <b>8NONE</b> (<i>default</i>), 8EVEN, 8ODD, 7EVEN, 7ODD</p> <p>Stop Bits – Sets the number of stop bits transmitted or received by the port; <i>Settings:</i> <b>1</b> (<i>default</i>), 2</p> <p>Line Terminator – Sets the termination character for data sent from the port; <i>Settings:</i> <b>CR/LF</b> (<i>default</i>), CR</p> <p>End of Line Delay – Sets the delay period from when a formatted line is terminated to the beginning of the next formatted serial output (0.1-second intervals); <i>Enter value:</i> 0–255, <b>0</b> (<i>default</i>)</p> <p>Echo – Specifies if characters received by the port are echoed back to the sending unit; <i>Settings:</i> <b>On</b> (<i>default</i>), Off</p> <p>Response – Specifies if the port transmits replies to serial commands; <i>Settings:</i> <b>On</b> (<i>default</i>), Off</p> <p>Address – Specifies address used to connect to the port (RS-485 only); Must be set to 0 for RS-422; <i>Enter value:</i> 0–255, <b>0</b> (<i>default</i>)</p> <p>Duplex – Specifies FULL (4-wire) or HALF (2-wire) duplex used to connect to the port (RS-485 only); <i>Settings:</i> <b>FULL</b> (<i>default</i>), HALF</p>

Table 4-10. Serial Menu Parameters (Continued)



### 4.5.4.2 USB Menu

This section provides a flow chart and descriptions for the USB menu.

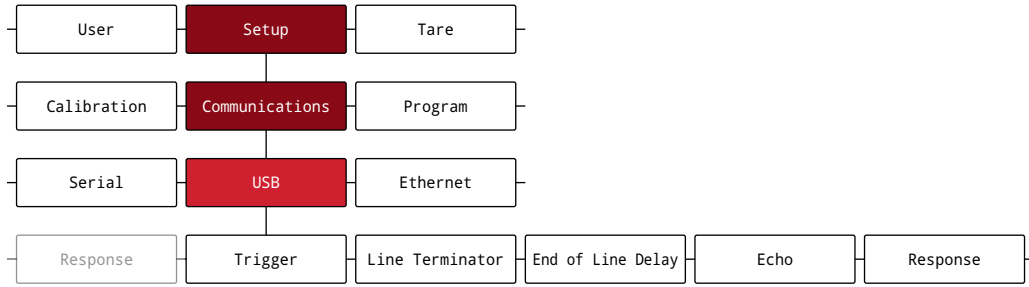


Figure 4-12. USB Menu

Parameter	Description
Trigger	Sets the input trigger type; <i>Settings:</i> <b>Command (default)</b> – Sets input trigger to command; allows operation of EDP commands and can print <i>Stream Industrial</i> – Scale data is updated up to configured sample rate; allows operation of EDP commands and printing <i>Stream Legal For Trade</i> – Scale data is updated at configured display update rate; allows operation of EDP commands and printing <i>Remote</i> – Configures the port to operate as a serial scale input
Line Terminator	Sets the termination character for data sent from the port; <i>Settings: CR/LF (default), CR</i>
End of Line Delay	Sets the delay period from when a formatted line is terminated to the beginning of the next formatted serial output (0.1-second intervals); <i>Enter value: 0–255, 0 (default)</i>
Echo	Specifies if characters received by the port are echoed back to the sending unit; <i>Settings: On (default), Off</i>
Response	Specifies if the port transmits replies to serial commands; <i>Settings: On (default), Off</i>

Table 4-11. USB Menu Parameters

### 4.5.4.3 Ethernet Menu

This section provides a flow chart and descriptions for the Ethernet menu.

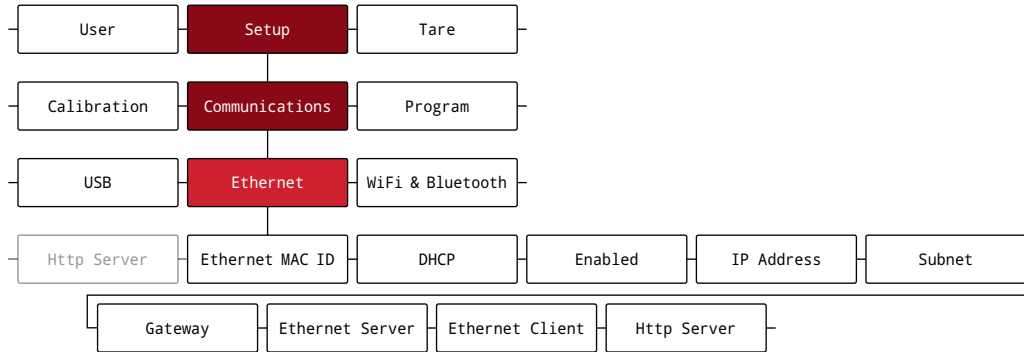


Figure 4-13. Ethernet Menu

Parameter	Description
Ethernet MAC ID	Displays the Ethernet MAC address (read only): 00:00:00:00:00:00
DHCP	Dynamic Host Configuration Protocol (static allocation of IP address when OFF); Settings: <b>On</b> (default), <i>Off</i>
Enabled	Enables Ethernet communications; Settings: <b>Off</b> (default), <i>On</i>
IP Address	IP Address; Enter value: <b>0.0.0.0</b> (default)
Subnet	Subnet Mask; Enter value: <b>255.255.255.0</b> (default)
Gateway	Default Gateway; Enter value: <b>0.0.0.0</b> (default)
Ethernet Server	Allows the 682 to receive external EDP commands; Sub-parameters: Trigger – Sets the input trigger type; Settings: <b>Command</b> (default), <i>Stream Industrial, Stream Legal For Trade, Remote Port</i> Remote Port – Specifies IP Address port to open to establish communications; Enter value: 1025–65535, <b>10001</b> (default) Name – Host name for Ethernet Server; Enter characters: <i>Alphanumeric entry up to 30 characters</i> , <b>0</b> (default) Line Terminator – Sets the termination character for data sent from the port; Settings: <b>CR/LF</b> (default), <i>CR</i> Echo – Specifies if characters received by the port are echoed back to the sending unit; Settings: <b>Off</b> (default), <i>On</i> Response – Specifies if the port transmits replies to serial commands; Settings: <b>On</b> (default), <i>Off</i>
Ethernet Client	Allows the 682 to send EDP commands to external devices; Sub-parameters: Trigger – Sets the input trigger type; Settings: <b>Command</b> (default), <i>Stream Industrial, Stream Legal For Trade, Remote</i> Remote IP Address – Sets the remote IP Address; Enter value: <b>0.0.0.0</b> (default) Remote Port – Specifies IP Address port to look for to establish communications; Enter value: 1025–65535, <b>10001</b> (default) Line Terminator – Sets the termination character for data sent from the port; Settings: <b>CR/LF</b> (default), <i>CR</i> Echo – Specifies if characters received by the port are echoed back to the sending unit; Settings: <b>On</b> (default), <i>Off</i> Response – Specifies if the port transmits replies to serial commands; Settings: <b>On</b> (default), <i>Off</i> End of Line Delay – Sets the delay period from when a formatted line is terminated to the beginning of the next formatted serial output (0.1-second intervals); Enter value: 0–255, <b>0</b> (default) Disconnect Time – Sets the disconnect timeout (in seconds); Enter value: 0–60, <b>0</b> (default)
Http Server	Enables the remote HTTP web server (Section 8.0 on page 74); Settings: <b>Off</b> (default), <i>On</i>

Table 4-12. Ethernet Menu Parameters

#### 4.5.4.4 WiFi & Bluetooth Menu

This section provides a flow chart and descriptions for the Wi-Fi and Bluetooth® menu.

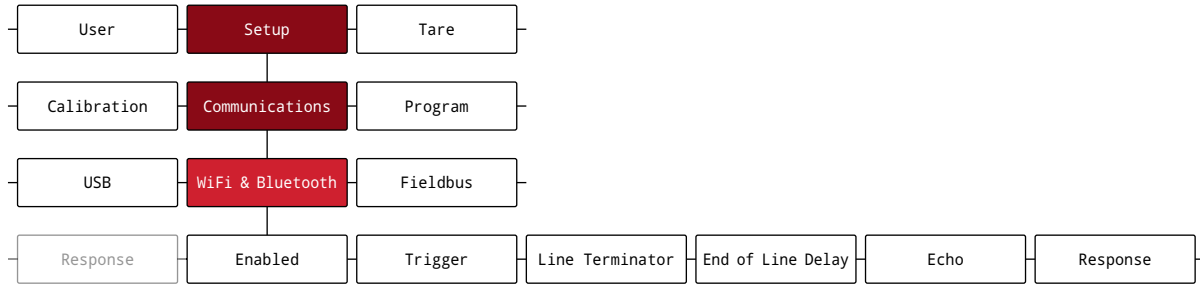


Figure 4-14. WiFi & Bluetooth Menu

Parameter	Description
Enabled	Enables the wireless module and specifies Wi-Fi and/or Bluetooth® communication; <i>Settings: OFF (default), WiFi, Bluetooth, Both</i>
Trigger	Sets the input trigger type; <i>Settings: Settings: Command (default), Stream Industrial, Stream Legal For Trade, Remote Command (default)</i> – Sets the input trigger to command; allows operation of EDP commands and can print <i>Stream Industrial</i> – Scale data is updated up to configured sample rate; allows operation of EDP commands and printing <i>Stream Legal for Trade</i> – Scale data is updated at configured display update rate; allows operation of EDP commands and printing <i>Remote</i> – Configures the port to operate as a serial scale input
Line Terminator	Sets the termination character for data sent from the port; <i>Settings: CR/LF (default), CR</i>
End of Line Delay	Sets the delay period from when a formatted line is terminated to the beginning of the next formatted serial output (0.1-second intervals); <i>Enter value: 0–255, 0 (default)</i>
Echo	Specifies if characters received by the port are echoed back to the sending unit; <i>Settings: On (default), Off</i>
Response	Specifies if the port transmits replies to serial commands; <i>Settings: On (default), Off</i>

Table 4-13. WiFi & Bluetooth Menu Parameters

#### 4.5.4.5 Fieldbus Menu

This section provides a flow chart and descriptions for the Fieldbus menu. The Fieldbus menu specifies the Network Protocol and associated settings. Fieldbus is enabled in the Serial menu ([Section 4.5.4.1 on page 47](#)).

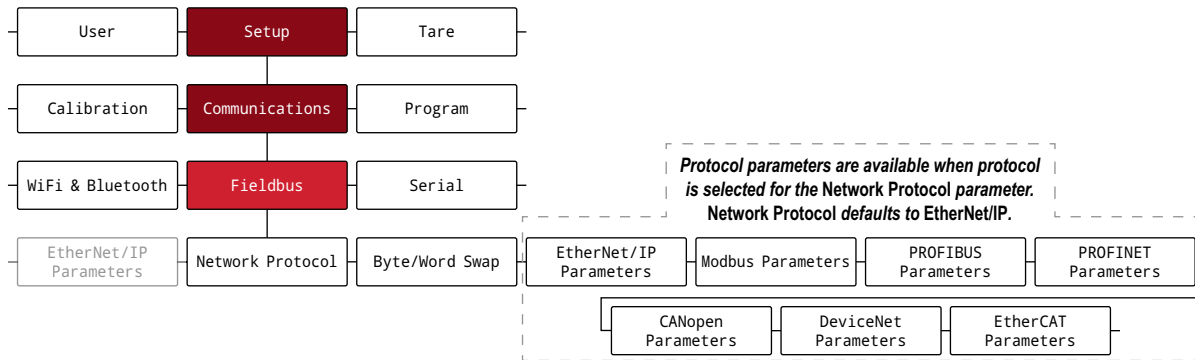


Figure 4-15. Fieldbus Menu

Parameter	Description
Network Protocol	Enables network protocol; <i>Settings: <b>EtherNet/IP</b> (default), Modbus, PROFIBUS, PROFINET, CANopen, DeviceNet, EtherCAT</i>
Byte/Word Swap	Enables Byte or Word swap, Both enables Byte and Word; If values are not being returned this parameter could possibly correct it; <i>Settings: <b>None</b> (default), Byte, Word, Both</i>
EtherNet/IP Parameters	Sub-Parameters: Auto IP – Automatically get network parameters from the network (DHCP); <i>Settings: <b>Off</b> (default), On</i> IP Address – Hidden if Auto IP is set to On; <i>Enter value: <b>0.0.0.0</b> (default)</i> Subnet – Hidden if Auto IP is set to On; <i>Enter value: <b>255.255.255.0</b> (default)</i> Gateway – Hidden if Auto IP is set to On; <i>Enter value: <b>0.0.0.0</b> (default)</i>
Modbus TCP Parameters	Sub-Parameters: Auto IP – Automatically get network parameters from the network (DHCP); <i>Settings: <b>Off</b> (default), On</i> IP Address – Hidden if Auto IP is set to On; <i>Enter value: <b>0.0.0.0</b> (default)</i> Subnet – Hidden if Auto IP is set to On; <i>Enter value: <b>255.255.255.0</b> (default)</i> Gateway – Hidden if Auto IP is set to On; <i>Enter value: <b>0.0.0.0</b> (default)</i>
PROFIBUS Parameters	Sub-Parameters: Node Address – <i>Enter value: 1-126, <b>1</b> (default)</i>
PROFINET Parameters	Sub-Parameters: Auto IP – Automatically get network parameters from the network (DHCP); <i>Settings: <b>Off</b> (default), On</i> IP Address – Hidden if Auto IP is set to On; <i>Enter value: <b>0.0.0.0</b> (default)</i> Subnet – Hidden if Auto IP is set to On; <i>Enter value: <b>255.255.255.0</b> (default)</i> Gateway – Hidden if Auto IP is set to On; <i>Enter value: <b>0.0.0.0</b> (default)</i>
CANopen Parameters	Sub-Parameters: Node Address – <i>Enter value: 1-128, <b>1</b> (default)</i> Node Rate – <i>Settings: <b>1 MB</b> (default), 10 KB, 20 KB, 50 KB, 100 KB, 125 KB, 250 KB, 500 KB, 800 KB</i>
DeviceNet Parameters	Sub-Parameters: Node Address – <i>Enter value: 1-64, <b>1</b> (default)</i> Node Rate – <i>Settings: 125 KB, 250 KB, <b>500 KB</b> (default)</i>
EtherCAT Parameters	Sub-Parameters: None – No sub-parameters are needed for EtherCAT

Table 4-14. Fieldbus Menu Parameters

### 4.5.5 Program Menu

This section provides a flow chart and descriptions for the Program menu.

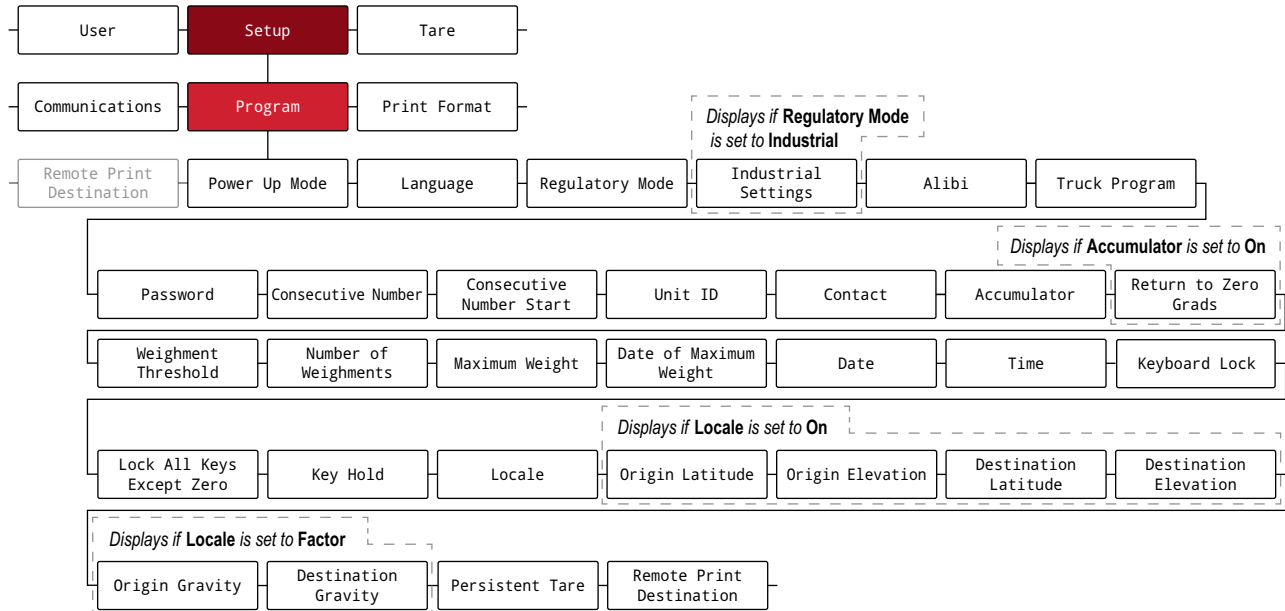


Figure 4-16. Program Menu

Parameter	Description
Power Up Mode	When the indicator is turned on, it performs a display test, then enters a warm up period; <i>Settings:</i> <b>GO (default)</b> – Performs display test, then enters <i>Weigh</i> mode after brief warm up period <b>DELAY</b> – Performs display test, then enters a warm up period of 30 seconds <ul style="list-style-type: none"> <li>• If no motion is detected during warm up period, indicator enters <i>Weigh</i> mode when warm up period ends</li> <li>• If motion is detected, the 30 second timer is reset and the warm up period is repeated</li> </ul>
Language	Specifies the text language for the 682 indicator; Applies to <i>Weigh</i> mode only; <i>Settings:</i> <b>English (default)</b> , <i>Spanish, French, German, Dutch, Portuguese, Italian</i>
Regulatory Mode	Specifies the regulatory agency having jurisdiction over the scale site; the value specified for this parameter affects the function of the front panel tare and zero keys; <i>Settings:</i> <b>NTEP (default)</b> , <i>OIML, Measurement Canada, Australia, Industrial, None</i> OIML, NTEP, Measurement Canada and Australia modes allow a tare to be acquired at a weight greater than zero; None allows tares to be acquired at any weight value OIML, NTEP, Measurement Canada and Australia modes allow a tare to be cleared only if the gross weight is at no load; None allows tares to be cleared at any weight value NTEP, OIML and Australia modes allow a new tare to be acquired even if a tare is already present; In Measurement Canada mode, the previous tare must be cleared before a new tare can be acquired None, NTEP and Measurement Canada modes allow the scale to be zeroed in either gross or net mode as long as the current weight is within the specified Zero Range (%); In OIML and Australia modes, the scale must be in gross mode before it can be zeroed; pressing the ZERO key in net mode clears the tare Australia mode does not display capacity and count-by with the weight value Industrial provides a set of sub-parameters to allow customization of tare, clear and print functions in non-Legal for Trade scale installations
Industrial Settings	Displays when Regulatory Mode parameter is set to Industrial; See <a href="#">Section 4.5.5.1 on page 55</a>
Alibi	Alibi can be toggled On/Off; if On, print transactions are stored in the Alibi Storage database (data validated with CRC) and can be viewed from the front panel of the 682 by configuring a softkey ( <a href="#">Section 3.4.19 on page 38</a> ) to Alibi; if Off, print transactions are not stored; Alibi data is stored in flash memory, no external memory is required; there is space for 128 KB of data or up to approximately 2000 print transactions; if the limit is hit, the first 4 KB of print transactions are deleted to free up space; <i>Settings:</i> <b>Off (default)</b> , <i>On</i>
Truck Program	Configurable parameters for Truck In/Out applications; <i>Sub-Parameters:</i> Mode – Truck modes track Truck IDs and weights with keyed tares and value swapping features in six preset modes; See <a href="#">Section 7.0 on page 71</a> ; <i>Settings:</i> <b>Off (default)</b> , <i>Mode 1, Mode 2, Mode 3, Mode 4, Mode 5, Mode 6</i> ID Overwrite – Allows duplicate Truck IDs to replace stored Truck IDs when enabled; <i>Settings:</i> <b>Disable (default)</b> , <i>Enable</i>

Table 4-15. Program Menu Parameters

Parameter	Description
Password	Configurable passwords to secure the User and Setup menus; ensure the audit jumper (J24) is in the ON position when using the Setup password; 999999 can be entered to overwrite either password if forgotten, overwriting the password clears configuration and calibration settings (use Revolution to backup settings before overwriting); <i>Sub-Parameters:</i> User – User menu password secures the user menu with configured password; <i>Enter characters: Up to 16 alphanumeric characters</i> Setup – Setup menu password secures the setup menu with configured password; <i>Enter characters: Up to 16 alphanumeric characters</i>
Consecutive Number	Allows sequential numbering for print operations; the value is incremented following each print operation that includes <CN> in the ticket format; <i>Enter value: 0–9999999, 0 (default)</i>
Consecutive Number Start	Specifies the initial consecutive number value used when the consecutive number is reset by activating Clear Consecutive Number digital input or sending KCLRCN EDP command; <i>Enter value: 0–9999999, 0 (default)</i>
Unit ID	Specifies the unit identification with an alphanumeric value; <i>Enter characters: Up to 8 alphanumeric characters, 1 (default)</i>
Contact	Contact Information; See <a href="#">Section 4.5.5.2 on page 56</a>
Accumulator	Accumulation can be toggled On/Off; if On, accumulation occurs on print operation; if Off, an accumulation does not occur; <i>Settings: Off (default), On</i>
Return to Zero Grads	Number of graduations from the zero base at which the accumulator re-arms itself; only visible if the Accumulator parameter is set to On; <i>Enter value: 0.0–100.0, 0.4 (default)</i>
Weight Threshold	Weight value that must be exceeded for the weight to be counted as a weighment; <i>Enter value: 0.0–9999999.0, 1000.0 (default)</i>
Number of Weighments	Displays the total number of weighments (read only)
Maximum Weight	Displays the maximum weight/weighment achieved (read only)
Date of Maximum Weight	Displays the date and time the maximum weight/weighment occurred (read only)
Date	Allows setting of the date format and date separator character Date Format – <i>Settings: MMDDYY (default), DDMMYY, YYMMDD, YYDDMM</i> Date Separator – <i>Settings: Slash (default), Dash, Semi, Dot</i>
Time	Allows setting of the time format and the separator character Time Format – <i>Settings: 12HOUR (default), 24HOUR</i> Time Separator – <i>Settings: Colon (default), Comma, Dot</i>
Keyboard Lock	Disables the keyboard except for the menu and power key; <i>Settings: Off (default), On</i>
Lock All Keys Except Zero	Disables the keyboard except for the zero, menu and power keys; <i>Settings: Off (default), On</i>
Key Hold	Allows setting of the key hold time and interval Key Hold Time – How long a key needs to be held before a key hold action is initiated (in tenths of a second); 20 equals 2 seconds; <i>Enter value: 10–50, 20 (default)</i> Key Hold Interval – The amount of time between increments during a key hold (in twentieths of a second); 2 equals a tenth of a second (10 increments per second during a key hold); <i>Enter value: 1–100, 2 (default)</i>
Locale	Enables location gravity compensation; <i>Settings:</i> <b>Off (default)</b> – gravity compensation disabled <b>On</b> – calculates gravity compensation using the origin and destination latitudes and elevations <b>Factor</b> – uses origin and destination gravity factors to find gravity compensation
Origin Latitude	Origin latitude (to nearest degree) for gravity compensation; displays when Locale parameter is set to On; <i>Enter value: 0–90, 45 (default)</i>
Origin Elevation	Origin elevation (in meters) for gravity compensation; displays when Locale parameter is set to On; <i>Enter value: -9999–9999, 345 (default)</i>
Destination Latitude	Destination latitude (to nearest degree) for gravity compensation; displays when Locale parameter is set to On; <i>Enter value: 0–90, 45 (default)</i>
Destination Elevation	Destination elevation (in meters) for gravity compensation; displays when Locale parameter is set to On; <i>Enter value: -9999–9999, 345 (default)</i>
Origin Gravity	Origin gravity factor (in m/s <sup>2</sup> ) for gravity compensation; displays when Locale parameter is set to Factor; <i>Enter value: 9.00000–9.99999, 9.80665 (default)</i>
Destination Gravity	Destination gravity factor (in m/s <sup>2</sup> ) for gravity compensation; displays when Locale parameter is set to Factor; <i>Enter value: 9.00000–9.99999, 9.80665 (default)</i>
Persistent Tare	Tare persists through a power cycle; <i>Settings: Off (default), On</i>
Remote Print Destination	Specifies if the 682 (Local) or another indicator (Remote) handles the print key; <i>Settings: Remote (default), Local</i>

Table 4-15. Program Menu Parameters (Continued)

### 4.5.5.1 Industrial Settings Menu

This section provides a flow chart and descriptions for the Industrial Settings menu. The Industrial Settings menu only displays if the Regulatory Mode parameter is set to Industrial.

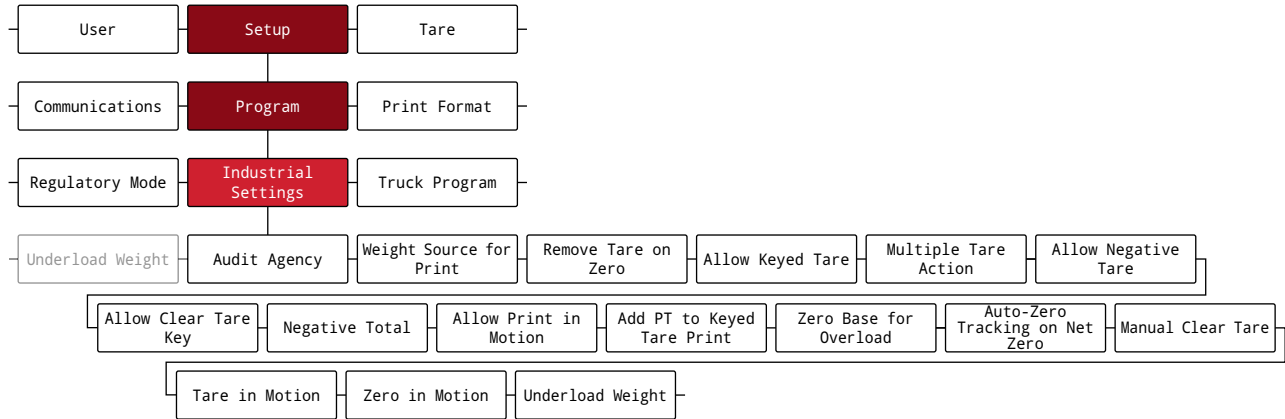


Figure 4-17. Industrial Settings Menu

Parameter	Description
Audit Agency	Audit trail display agency format; Settings: <b>NTEP</b> (default), Measurement Canada, None, OIML
Weight Source for Print	Display or scale weight source for print; Settings: <b>Display</b> (default), Captured Scale Zero
Remove Tare on Zero	Remove tare on zero; Settings: <b>No</b> (default), Yes
Allow Keyed Tare	Always allow keyed tare; Settings: <b>Yes</b> (default), No
Multiple Tare Action	Replaces existing tare when the tare key is pressed; Settings: <b>Replace</b> (default), Remove, Nothing
Allow Negative Tare	Allow negative or zero tare; Settings: <b>No</b> (default), Yes
Allow Clear Tare Key	Allow clear key to clear tare or accumulator when displayed; Settings: <b>Yes</b> (default), No
Negative Total	Allow total scale to display negative value; Settings: <b>No</b> (default), Yes
Allow Print in Motion	Allow print while in motion; Settings: <b>No</b> (default), Yes
Add PT to Keyed Tare Print	Add preset tare (PT) to keyed tare print; Settings: <b>Yes</b> (default), No
Zero Base for Overload	Zero base for overload calculation; Settings: <b>Calibrated Zero</b> (default), Captured Scale Zero
Auto-Zero Tracking on Net Zero	Perform auto zero tracking on net zero; Settings: <b>No</b> (default), Yes
Manual Clear Tare	Allow manual clearing of the tare value; Settings: <b>Yes</b> (default), No
Tare in Motion	Allow tare in motion; Settings: <b>No</b> (default), Yes
Zero in Motion	Allow scale to be zeroed while in motion; Settings: <b>No</b> (default), Yes
Underload Weight	Underload weight value in display divisions; Enter value: 1-999999, <b>20</b> (default)

Table 4-16. Industrial Settings Menu Parameters

### 4.5.5.2 Contact Information Menu

This section provides a flow chart and descriptions for the Contact Information menu.

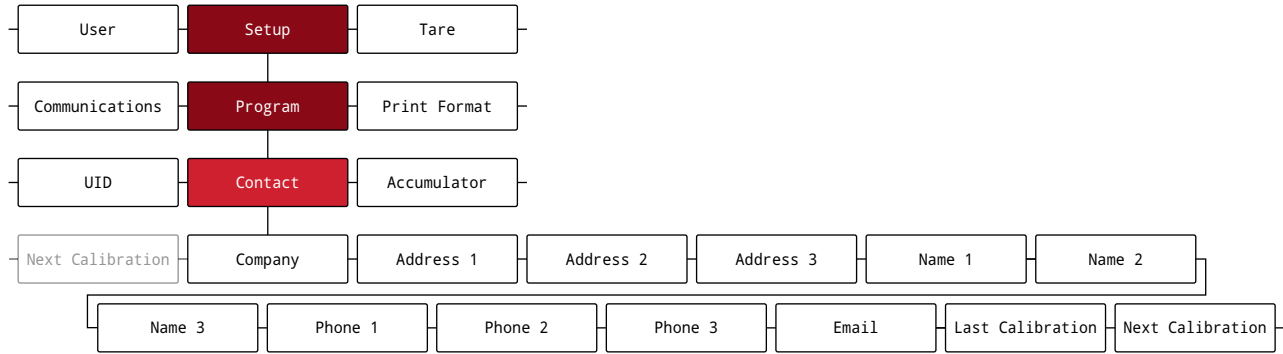


Figure 4-18. Contact Information Menu

Parameter	Description
Company	Contact company name; <i>Enter characters: Alphanumeric entry up to 30 characters</i>
Address 1-3	Contact company address lines; <i>Enter characters: Alphanumeric entry up to 20 characters (for each line)</i>
Name 1-3	Contact names; <i>Enter characters: Alphanumeric entry up to 30 characters (for each line)</i>
Phone 1-3	Contact phone numbers; <i>Enter characters: Alphanumeric entry up to 20 characters (for each line)</i>
Email	Contact email address; <i>Enter characters: Alphanumeric entry up to 40 characters</i>
Last Calibration	Last calibration date; <i>Enter value: 8-digit number (MMDDYYYY)</i>
Next Calibration	Next calibration date; <i>Enter value: 8-digit number (MMDDYYYY)</i>

Table 4-17. Contact Information Menu Parameters

### 4.5.6 Print Format Menu

This section provides a flow chart and descriptions for the Print Format menu.

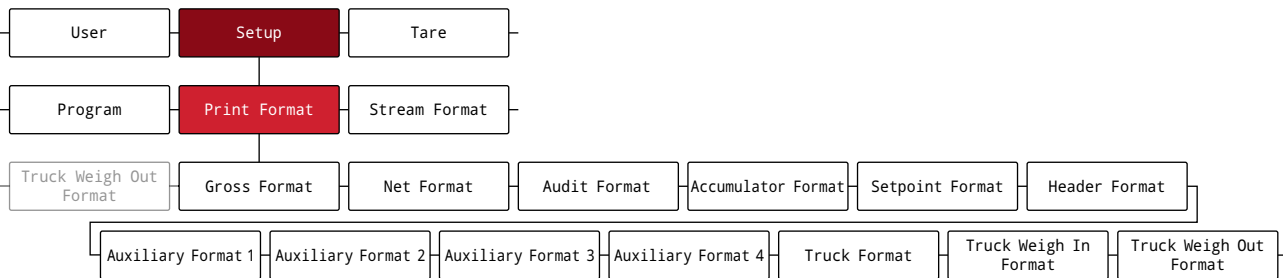


Figure 4-19. Print Format Menu

Parameter	Description
Gross Format	Gross demand print format string Format – <i>Enter characters: Alphanumeric entry up to 1,000 characters, GROSS&lt;G&gt;&lt;NL&gt;&lt;TD&gt;&lt;NL&gt; (default)</i> Destination Port 1-2 – Destination ports; Settings: <b>RS-232 Port 1</b> (Port 1 default), RS-232 Port 2, RS-485, TCP Client 1, TCP Server, USB, Serial Option Card Port 1, Serial Option Card Port 2, WiFi & Bluetooth, None (Port 2 default)
Net Format	Net demand print format string Format – <i>Enter characters: Alphanumeric entry up to 1,000 characters, GROSS&lt;G&gt;&lt;NL&gt;TARE&lt;SP&gt;&lt;T&gt;&lt;NL&gt;NET&lt;SP2&gt;&lt;N&gt;&lt;NL2&gt;&lt;TD&gt;&lt;NL&gt; (default)</i> Destination Port 1-2 – Destination ports; Settings: <b>RS-232 Port 1</b> (Port 1 default), RS-232 Port 2, RS-485, TCP Client 1, TCP Server, USB, Serial Option Card Port 1, Serial Option Card Port 2, WiFi & Bluetooth, None (Port 2 default)

Table 4-18. Print Format Menu Parameters



Parameter	Description
Audit Format	Audit destination print ports where the audit parameters are sent when an Audit Dump is done Destination Port 1-2 – Dump audit destination ports; Settings: <b>RS-232 Port 1</b> (Port 1 default), RS-232 Port 2, RS-485, TCP Client 1, TCP Server, USB, Serial Option Card Port 1, Serial Option Card Port 2, WiFi & Bluetooth, None (Port 2 default)
Accumulator Format	Accumulator print format string Format – Enter characters: Alphanumeric entry up to 1,000 characters, ACCUM <A><NL><DA> <TI><NL> (default) Destination Port 1-2 – Destination ports; Settings: <b>RS-232 Port 1</b> (Port 1 default), RS-232 Port 2, RS-485, TCP Client 1, TCP Server, USB, Serial Option Card Port 1, Serial Option Card Port 2, WiFi & Bluetooth, None (Port 2 default)
Setpoint Format	Setpoint print format string Format – Enter characters: Alphanumeric entry up to 1,000 characters, <SCV><SP><SPM><NL> (default) Destination Port 1-2 – Destination ports; Settings: <b>RS-232 Port 1</b> (Port 1 default), RS-232 Port 2, RS-485, TCP Client 1, TCP Server, USB, Serial Option Card Port 1, Serial Option Card Port 2, WiFi & Bluetooth, None (Port 2 default)
Header Format	Ticket header format strings Header Format 1 – Header 1 Format String; Enter characters: Alphanumeric entry up to 1,000 characters, COMPANY NAME<NL>STREET ADDRESS<NL>CITY, ST ZIP<NL2> (default) Header Format 2 – Header 2 Format String; Enter characters: Alphanumeric entry up to 1,000 characters, COMPANY NAME<NL>STREET ADDRESS<NL>CITY, ST ZIP<NL2> (default)
Auxiliary Format 1-4	Auxiliary print format strings Format 1-4 – Enter characters: Alphanumeric entry up to 1,000 characters, GROSS<G><NL2><TD><NL> (default) Destination Port 1-2 – Destination ports; Settings: <b>RS-232 Port 1</b> (Port 1 default), RS-232 Port 2, RS-485, TCP Client 1, TCP Server, USB, Serial Option Card Port 1, Serial Option Card Port 2, WiFi & Bluetooth, None (Port 2 default) <b>NOTE: Auxiliary Formats can be printed using softkeys (Section 3.4.19 on page 38) or by pressing the corresponding format number on the numeric keypad, followed by the PRINT key. For example, to print Auxiliary Format 2, press the 2 key, followed by the PRINT key.</b>
Truck Format	Truck print format string Format – Enter characters: Alphanumeric entry up to 1,000 characters, REG ID: <TID>: <TR2> <TD><NL> (default) Destination Port 1-2 – Destination ports; Settings: <b>RS-232 Port 1</b> (Port 1 default), RS-232 Port 2, RS-485, TCP Client 1, TCP Server, USB, Serial Option Card Port 1, Serial Option Card Port 2, WiFi & Bluetooth, None (Port 2 default)
Truck Weigh In Format	Truck weigh in print format string Format – Enter characters: Alphanumeric entry up to 1,000 characters, <NL>ID<SP><TID><NL2>GROSS<SP><TR1><NL2><DA><SP><TI><NL> (default) Destination Port 1-2 – Destination ports; Settings: <b>RS-232 Port 1</b> (Port 1 default), RS-232 Port 2, RS-485, TCP Client 1, TCP Server, USB, Serial Option Card Port 1, Serial Option Card Port 2, WiFi & Bluetooth, None (Port 2 default)
Truck Weigh Out Format	Truck weigh out print format string Format – Enter characters: Alphanumeric entry up to 1,000 characters, <NL6>ID<SP><TID><NL2>GROSS<TR1><NL>TARE<SP><TR2><NL>NET<SP2><TR3><NL2><DA><SP><TI><NL> (default) Destination Port 1-2 – Destination ports; Settings: <b>RS-232 Port 1</b> (Port 1 default), RS-232 Port 2, RS-485, TCP Client 1, TCP Server, USB, Serial Option Card Port 1, Serial Option Card Port 2, WiFi & Bluetooth, None (Port 2 default)

Table 4-18. Print Format Menu Parameters (Continued)

## 4.5.7 Stream Format Menu

This section provides a flow chart and descriptions for the Stream Format menu.

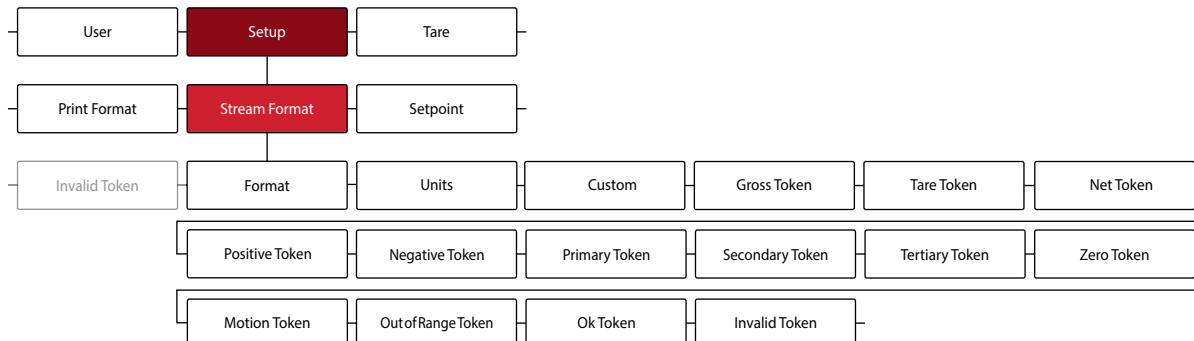


Figure 4-20. Stream Format Menu

Parameter	Description
Format	Specifies the stream format used for streaming output of scale data or specifies the expected input for a serial scale; <i>Settings:</i> <b>RLWS</b> (default) – Rice Lake Weighing Systems stream format (Section 16.5.1 on page 127) <b>Cardinal</b> – Cardinal stream format (Section 16.5.2 on page 127) <b>Weigh-Tronix</b> – Avery Weigh-Tronix stream format (Section 16.5.3 on page 128) <b>Toledo</b> – Mettler Toledo stream format (Section 16.5.4 on page 128) <b>Minebea</b> – Minebea stream format (Section 16.5.5 on page 129) <b>Custom</b> – Custom stream format <b>NOTE: Custom parameter is for input only. When set to remote, the port does not stream data (see Table 4-10 on page 47)</b>
Units	Specifies whether the streaming unit tokens remain static or dynamically updated with the configured units; Static uses set Primary/Secondary unit tokens and Dynamic defaults to configured units of the scale; <i>Settings:</i> <b>STATIC</b> (default), <b>DYNAMIC</b>
Custom	Specifies the custom stream format; only displays if SFORMAT is set to CUSTOM; see Section 16.6 on page 129 for available stream format tokens; <i>Enter characters:</i> Alphanumeric entry up to 1,000 characters
Gross Token	Mode token when streaming the gross weight; <i>Enter characters:</i> Alphanumeric entry up to 8 characters, <b>G</b> (default)
Tare Token	Mode token when streaming the tare weight; <i>Enter characters:</i> Alphanumeric entry up to 8 characters, <b>T</b> (default)
Net Token	Mode token when streaming the net weight; <i>Enter characters:</i> Alphanumeric entry up to 8 characters, <b>N</b> (default)
Positive Token	Polarity token when the weight is positive; <i>Settings:</i> <b>Space</b> (default), <b>None</b> , <b>+</b>
Negative Token	Polarity token when the weight is negative; <i>Settings:</i> <b>Space</b> , <b>None</b> , <b>-</b> (default)
Primary Token	Units token when streaming primary units; <i>Enter characters:</i> Alphanumeric entry up to 8 characters, <b>L</b> (default)
Secondary Token	Units token when streaming secondary units; <i>Enter characters:</i> Alphanumeric entry up to 8 characters, <b>K</b> (default)
Tertiary Token	Units token when streaming tertiary units; <i>Enter characters:</i> Alphanumeric entry up to 8 characters, <b>K</b> (default)
Zero Token	Status token when the weight is at center of zero; <i>Enter characters:</i> Alphanumeric entry up to 2 characters, <b>Z</b> (default)
Motion Token	Status token when the weight is in motion; <i>Enter characters:</i> Alphanumeric entry up to 2 characters, <b>M</b> (default)
Out of Range Token	Status token when the weight is out of range; <i>Enter characters:</i> Alphanumeric entry up to 2 characters, <b>O</b> (default)
Ok Token	Status token when the weight is OK (not invalid, out-of-range, at zero or in-motion); <i>Enter characters:</i> Alphanumeric entry up to 2 characters (default is a space)
Invalid Token	Status token when streaming an invalid weight; <i>Enter characters:</i> Alphanumeric entry up to 2 characters, <b>I</b> (default)

Table 4-19. Stream Format Menu Parameters

### 4.5.8 Setpoint Menu

The following sections provide flow charts and descriptions for the Setpoint menu.

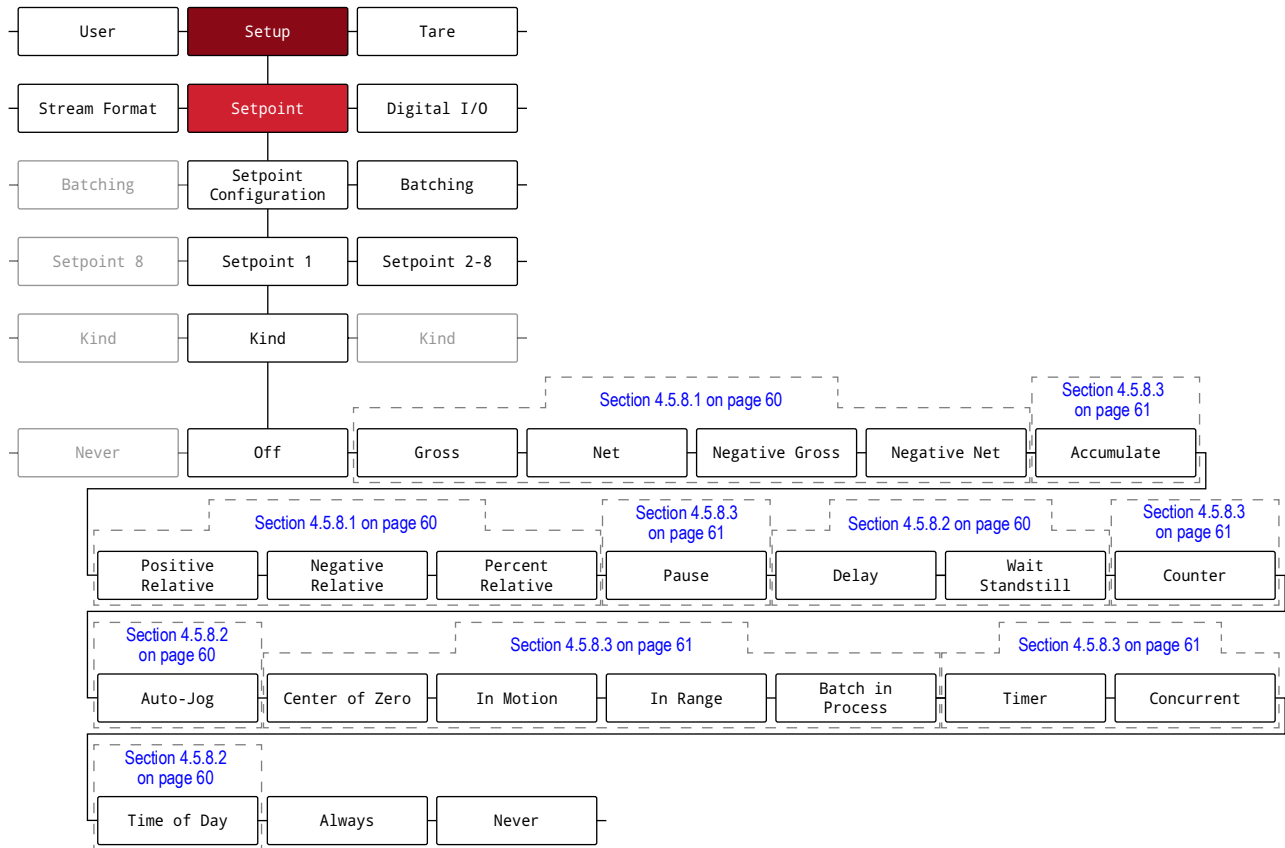


Figure 4-21. Setpoint Menu

Parameter	Description
Setpoint Configuration	Access to configuration parameters and settings for up to eight setpoints; <i>Settings: Setpoint 1-8</i> <i>Kind – Setpoint Kind; Settings: Off (default), Gross, Net, Negative Gross, Negative Net, Accumulate, Positive Relative, Negative Relative, Percent Relative, Pause, Delay, Wait Standstill, Counter, Auto-Jog, Center of Zero, In Motion, In Range, Batch in Process, Timer, Concurrent, Time Of Day, Always, Never</i>
Batching	Batch sequence runs when set to Auto or Manual; <i>Settings:</i> <b>Off (default)</b> <i>Auto – Allows the batch sequence to repeat automatically once it has been started</i> <i>Manual – Requires a Batch Start input/command to run the batch sequence</i>

Table 4-20. Setpoints Menu Parameters

4.5.8.1 If Kind = Gross, Net, Negative Gross, Negative Net, Positive Relative, Negative Relative, Percent Relative

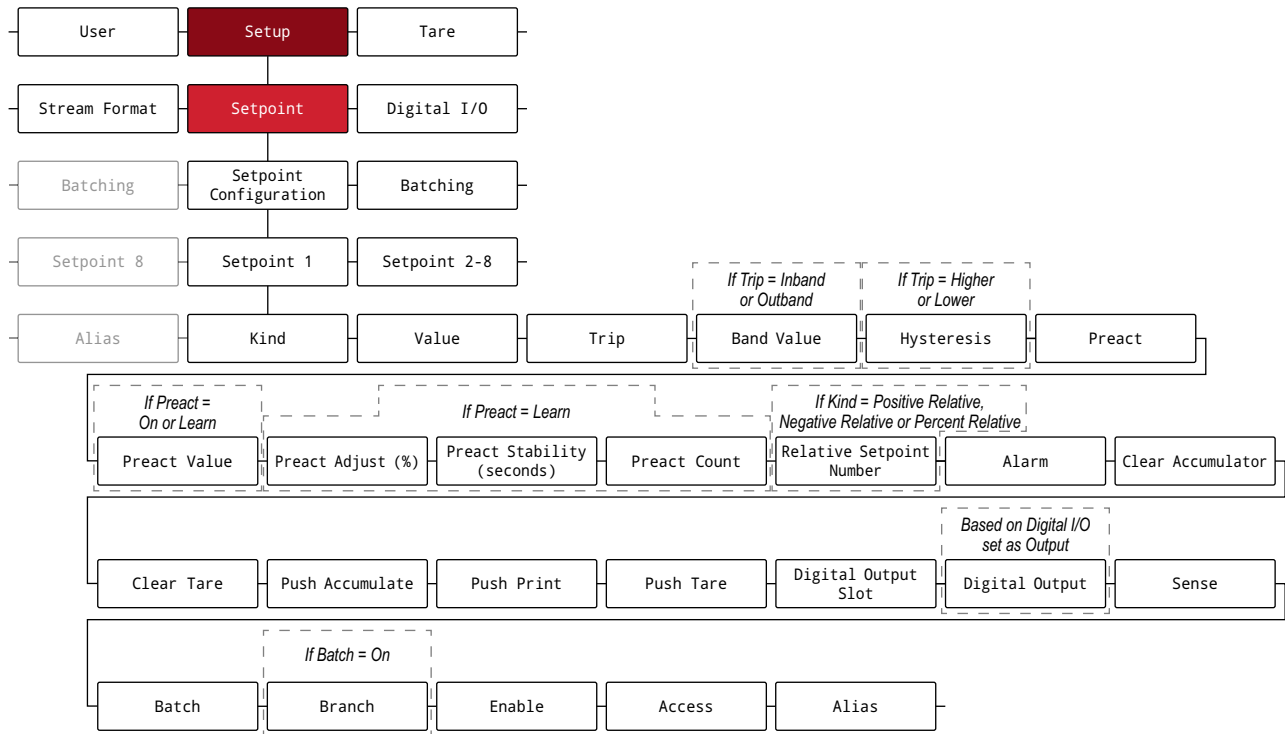


Figure 4-22. Setpoints Parameter Group A

4.5.8.2 If Kind = Accumulate, Delay, Wait Standstill, Auto-Jog, Time Of Day

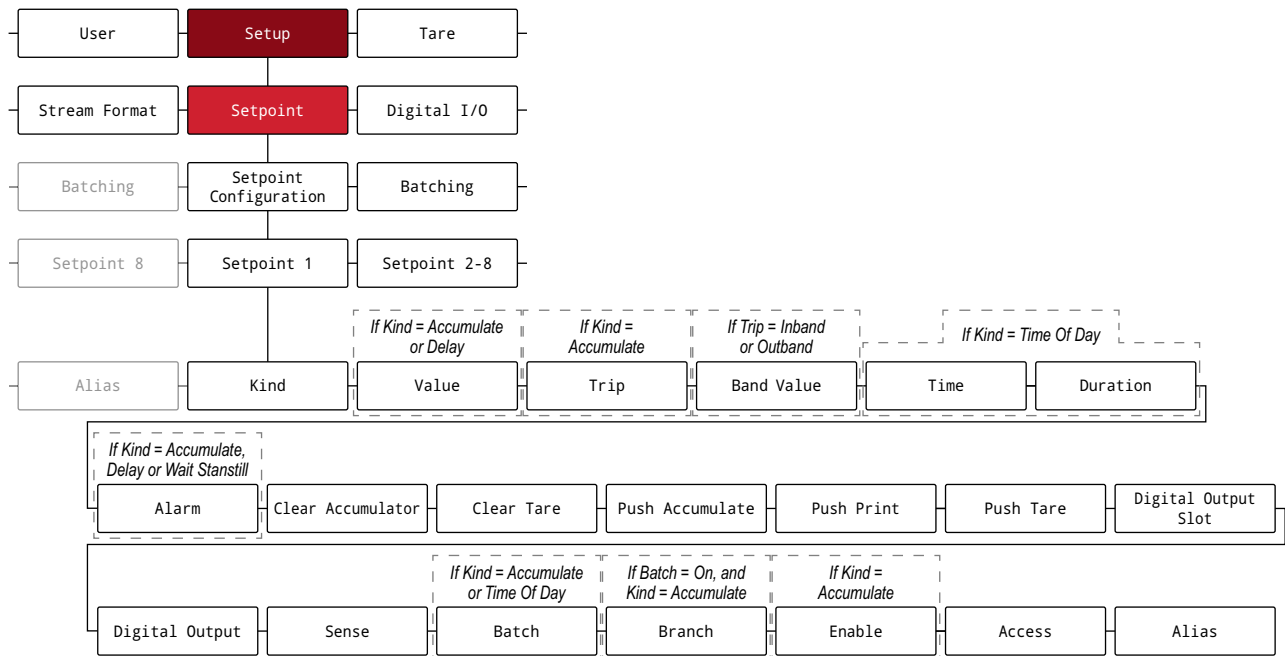


Figure 4-23. Setpoints Parameter Group B

### 4.5.8.3 If Kind = Pause, Counter, Center of Zero, In Motion, In Range, Batch in Process, Timer, Concurrent

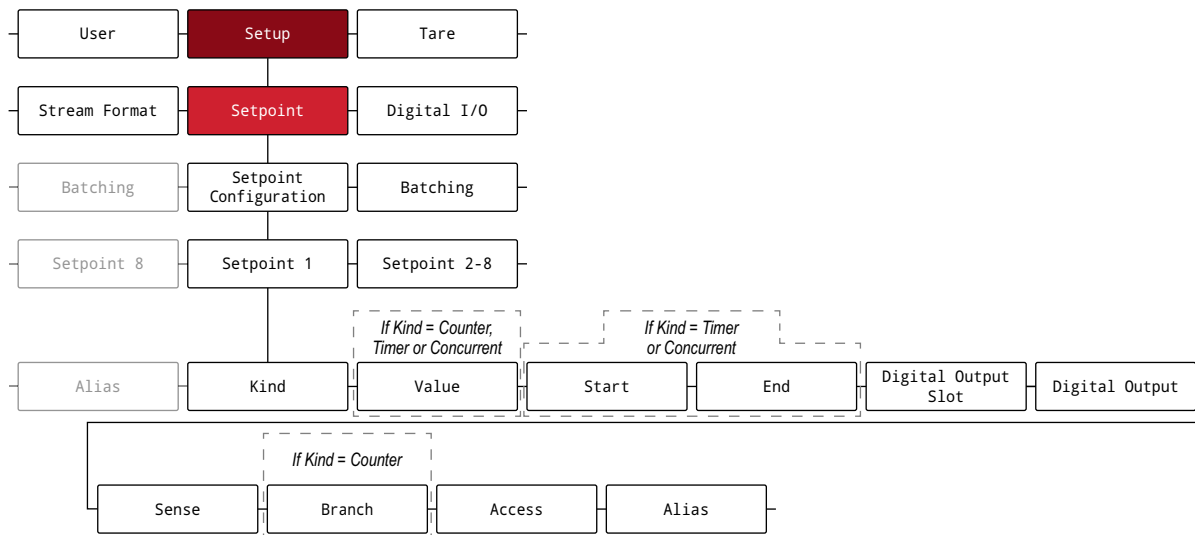


Figure 4-24. Setpoints Parameter Group C

Parameter	Description
Value	For weight-based setpoints: Enter value: 0.0–9999999.0, <b>0.0</b> (default) For time-based setpoints: Enter value: 0.0–65535.0, <b>0.0</b> (default) For Counter setpoints: Enter value: 0.0–65535.0, <b>0.0</b> (default)
Trip	Specifies whether the setpoint is satisfied when the weight is higher or lower than the setpoint value, within a band established around the value, or outside of the band; in a batch sequence with Trip = Higher, the associated digital output is active until the setpoint value is reached or exceeded; with Trip = Lower, the output is active until the weight goes below the setpoint value; Settings: <b>Higher</b> (default), Lower, Inband, Outband
Band Value	For setpoints with Trip = Inband or Outband, specifies a weight equal to half the band width; The band established around the setpoint value is Value ± Band Value; Enter value: 0.0–9999999.0, <b>0.0</b> (default)
Hysteresis	Specifies a band around the setpoint value which must be exceeded before the setpoint, once off, can trip on again; Enter value: 0.0–9999999.0, <b>0.0</b> (default)
Preact	Allows the digital output associated with a setpoint to shut off before the setpoint is satisfied to allow for material in suspension; Settings: <b>Off</b> (default) On – Adjusts setpoint trip value up or down (depending on the Trip parameter setting) from setpoint value using a fixed value specified on the Preact Value parameter Learn – Can be used to automatically adjust the Preact value after each batch; it compares the actual weight at standstill to the target setpoint value and adjusts the Preact Value by the Preact Adjust (%) value times the difference after each batch
Start	Specifies starting setpoint number; do not specify number of the Timer or Concurrent setpoint itself; Timer or Concurrent setpoint begins when starting setpoint begins; Enter value: 1–8, <b>1</b> (default)
End	Specifies ending setpoint number; do not specify number of the Timer or Concurrent setpoint itself; Timer or Concurrent setpoint stops when ending setpoint begins; Enter value: 1–8, <b>1</b> (default)
Time	For Time Of Day setpoints, specifies the time at which the setpoint becomes active; the format used to enter the time (12hour or 24hour) is based on the value specified for the Time Format parameter in the Program menu (HHMM); Enter value: <b>0000</b> (default)
Duration	For Time Of Day setpoints; specifies the length of time the digital output associated with this setpoint changes state; value is entered in hours, minutes and seconds (HHMMSS); Enter value: <b>000000</b> (default)
Preact Value	Specifies the preact value for setpoints with Preact set to On or Learn; depending on the Trip setting specified for the setpoint, the setpoint trip value is adjusted up or down by the Preact Value; Enter value: 0.0–9999999.0, <b>0.0</b> (default)
Preact Adjust (%)	Setpoints with Preact set to Learn, specifies a decimal representation of the percentage of error correction applied (50.0 = 50%, 100.0 = 100%) each time a Preact adjustment is made; Enter value: 0.0–100.0, <b>50.0</b> (default)
Preact Stability (seconds)	Setpoints with Preact set to Learn, specifies the time, in 0.1-sec intervals, to wait for standstill before adjusting the Preact value; setting this parameter to a value greater than zero disables the learn process if standstill is not achieved in the specified interval (in tenths of a second); Enter value: 0–65535, <b>0</b> (default)
Preact Count	Setpoints with Preact set to Learn, specifies the number of batches after which the preact value is recalculated; the default value, 1, recalculates the preact value after every batch cycle; Enter value: 1–65535, <b>1</b> (default)

Table 4-21. Kind Parameter Descriptions

Parameter	Description
Relative Setpoint Number	For relative setpoints, specifies the number of the relative setpoint; <i>Enter value: 1–8, 1 (default)</i> Target weight for this setpoint is determined as follows: Positive Relative setpoints, the value of the relative setpoint plus the value (Value parameter) of the Positive Relative setpoint Negative Relative setpoints, the value of the relative setpoint minus the value of the Negative Relative setpoint Percent Relative setpoints, the percentage (specified on Value parameter of the Percent Relative setpoint) of the target value of the relative setpoint
Alarm	Specify On to display the word Alarm on the primary display while the setpoint is active (batch setpoints) or while the setpoint is not tripped (continuous setpoints); <i>Settings: Off (default), On</i>
Clear Accumulator	Specify On to clear the accumulator when the setpoint is satisfied; <i>Settings: Off (default), On</i>
Clear Tare	Specify On to clear the tare when the setpoint is satisfied; <i>Settings: Off (default), On</i>
Push Accumulator	Specify On to update the accumulator and perform a print operation when the setpoint is satisfied; specify On Quiet to update the accumulator without printing; <i>Settings: Off (default), On, On Quiet</i>
Push Print	Specify On to perform a print operation when the setpoint is satisfied; specify Wait Standstill to wait for standstill after setpoint is satisfied before printing; <i>Settings: Off (default), On, Wait Standstill</i>
Push Tare	Specify On to perform an acquire tare operation when the setpoint is satisfied; <i>Settings: Off (default), On</i> <b>NOTE: Push Tare acquires the tare regardless of the value specified for the Regulatory Mode parameter in the Program menu</b>
Digital Output Slot	Lists all available digital I/O slots; this parameter specifies the slot number of the digital I/O card referenced by the Digital Output setpoint; Slot 0 for on-board DIO, Slot 1 for Optional Relay Board; <i>Settings: None (default), 0, 1</i>
Digital Output	Lists all digital output bit numbers available for the specified Digital Output Slot; this parameter is used to specify the digital output bit associated with this setpoint; use the Digital I/O menu to assign bit function to Output; <i>Enter value: 1–4, 1 (default)</i> <b>NOTE: For continuous setpoints, the digital output becomes active (low) when the condition is met; for batch setpoints, the digital output is active until the setpoint condition is met</b>
Sense	Specifies whether the value of the digital output associated with this setpoint is inverted when the setpoint is satisfied; <i>Settings: Normal (default), Invert</i>
Batch	Specifies whether the setpoint is used as a batch (On) or continuous (Off) setpoint; <i>Settings: Off (default), On</i>
Branch	Specifies the setpoint number to which the batch sequence is to branch, if the current setpoint is not satisfied upon initial evaluation (0 = do not branch); <i>Enter value: 0–8, 0 (default)</i>
Enable	Specifies if setpoint parameters display in User mode; <i>Settings: On (default), Off</i>
Access	Specifies the access allowed to setpoint parameters in User mode; <i>Settings:</i> <b>On (default)</b> – Values can be displayed and changed <b>HIDE</b> – Values cannot be displayed or changed <b>OFF</b> – Values can be displayed but not changed
Alias	Name for the setpoint; <i>Enter characters: Alphanumeric entry up to 8 characters, SETPT# (default)</i>

Table 4-21. Kind Parameter Descriptions (Continued)

### 4.5.9 Digital I/O Menu

This section provides a flow chart and descriptions for the Digital I/O menu.

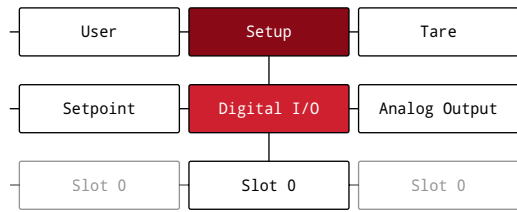


Figure 4-25. Digital I/O Menu

Parameter	Description
Bit 1-4	Digital I/O Bit 1-4 – Specifies the mode and function of the digital I/O pins; <i>Settings: Off (default), Print, Zero, Tare, Units, Primary, Secondary, Clear, Display Accumulator, Display Tare, Clear Accumulator, Clear Tare, Net/Gross, Gross, Net, Clear Consecutive Number, Keyboard Lock, Batch Run, Batch Start, Batch Pause, Batch Reset, Batch Stop, Output, Softkey 1-15</i>

Table 4-22. Digital I/O Menu Parameters

### 4.5.10 Analog Output Menu

This section provides a flow chart and descriptions for the Analog Output menu. The Analog Output menu is only functional if the analog output option card is installed. If the option card is not installed, the menu is visible, but not functional. If the analog output option card is installed, configure all other indicator functions and calibrate the indicator before configuring the analog output. Instructions to install and setup the analog output option card are provided with the option card kit (PN 195084).

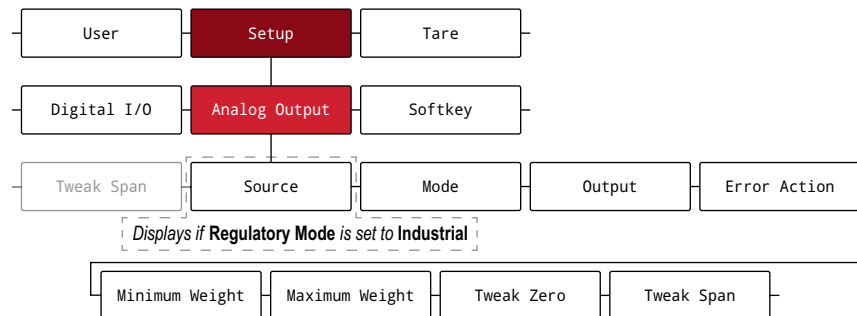


Figure 4-26. Analog Output Menu

Parameter	Description
Source	Specifies the scale tracked by the analog output; Only appears if the Regulatory Mode parameter is set to Industrial; <i>Settings: Scale 1 (default), Remote</i>
Mode	Specifies the weight data, gross or net, tracked by the analog output when the Source parameter is assigned to a scale; <i>Settings: Gross (default), Net</i>
Output	Specifies the type/range of the output; <i>Settings: 0-10V (default), 0-20mA, 4-20mA</i>
Error Action	Specifies how the analog output responds to system error conditions; <i>Settings:</i> <b>Full Scale (default)</b> – Set to full scale (10 V or 20 mA) <i>Hold</i> – Holds current value <b>Zero Scale</b> – Sets to zero value (0 V, 0 mA or 4 mA)
Minimum Weight	Specifies the minimum weight value tracked by the analog output; <i>Enter value: ±9999999.0, 0.0 (default)</i>
Maximum Weight	Specifies the maximum weight value tracked by the analog output; <i>Enter value: ±9999999.0, 10000.0 (default)</i>
Tweak Zero	Adjusts the offset of the analog output zero value; <i>Enter value: 0-65535, 0 (default)</i>
Tweak Span	Adjusts the offset of the analog output span value; <i>Enter value: 0-65535, 59515 (default)</i>

Table 4-23. Analog Output Menu Parameters



### 4.5.11 Softkey Menu

This section provides a flow chart and descriptions for the Softkey menu. Softkeys are configured to provide additional operator functions. Configured softkeys are at the bottom of the display and are activated by the physical key directly below them. If six or more softkeys are enabled, left and right arrows appear in the outside softkeys to allow navigation between available softkeys. See [Section 3.4.19 on page 38](#) for softkey configuration procedure.

#### Softkey Assignment Menu

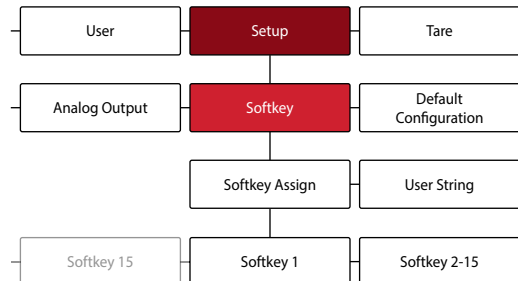


Figure 4-27. Softkey Menu

Parameter	Description
Softkey 1-15	Specifies the operator function assigned to each available softkey; see <a href="#">Section 3.4.19 on page 38</a> to configure softkeys; Settings: <b>Blank</b> (default), Time Date, Display Tare, Display Accumulator, Setpoint, Batch Stop, Batch Start, Batch Pause, Batch Reset, Display UID, Alibi, Weigh In, Weigh Out, Truck Regs, Auxiliary Format 1-4, Stop, Go, User String 1, Count Average, Shrink, Clear Shrink, Clear Accumulator, Print Accumulator, Off

Table 4-24. Softkey Menu Parameters

Softkey	Description
Blank	No softkey configured (default selection for all); a blank softkey can be used to create separation between other softkeys
Time/Date	Displays Set System Time with the ability to view and edit the current time value ( <a href="#">Section 3.4.15 on page 35</a> ); pressing the middle softkey causes the Set System Date ( <a href="#">Section 3.4.16 on page 36</a> ) to display
Display Tare	Displays the tare value in the message area of the front panel display
Display Accumulator	Displays the accumulator value and count; accumulator can be turned On in the Program menu ( <a href="#">Section 4.5.5 on page 53</a> )
Setpoint	Displays the User Setpoint menu ( <a href="#">Section 4.4 on page 42</a> ), which includes the setpoint value of configured setpoints; Read only unless access parameter for the setpoint is set to ON; menu is empty if no setpoints are configured
Batch Stop	Stops an active batch and turns off all associated digital outputs; requires a Batch Start to resume processing
Batch Start	Starts a batch from the current step if a Batch Run digital input is active or not defined; if a Batch Run digital input is defined and inactive, Batch Start resets the batch to the first step
Batch Pause	Pauses an active batch and turns off all digital outputs except those associated with Concurrent and Timer setpoints; processing is suspended until the indicator receives a Batch Start signal; pressing the Batch Start softkey, BATSTRT digital input or BATSTART serial command resumes the batch and re-energizes all digital outputs turned off by the Batch Pause
Batch Reset	Stops an active batch and resets the current step to the first batch step; all digital outputs associated with batch setpoints are deactivated; if a batch is stopped or paused, Batch Reset resets the current step to the first step
Display UID	Displays the Unit ID in the message area of the front panel display
Alibi	Displays Alibi Storage and allows previous print transactions to be reprinted; Alibi parameter must be set to On in the Program menu ( <a href="#">Section 4.5.5 on page 53</a> )
Weigh In	Displays the keyboard truck ID entry screen to log a truck weigh in ( <a href="#">Section 7.3 on page 73</a> )
Weigh Out	Displays the keyboard truck ID entry screen to log a truck weigh out ( <a href="#">Section 7.4 on page 73</a> )
Truck Regs	Displays the Truck Register ( <a href="#">Section 7.2 on page 72</a> )
Auxiliary Format 1-4	Prints using the configured auxiliary print format string to the configured destination port ( <a href="#">Section 4.5.6 on page 56</a> )
Stop	Sends Auxiliary Format 1 out of its configured destination port to activate the red Stop light of a LaserLight Remote Display ( <a href="#">Section 13.4 on page 113</a> )
Go	Sends Auxiliary Format 2 out of its configured destination port to activate the green Go light of a LaserLight Remote Display ( <a href="#">Section 13.4 on page 113</a> )
User String 1	Prompts User String 1 data entry ( <a href="#">Section 12.21 on page 107</a> )

Table 4-25. Softkey Descriptions



Softkey	Description
Count Average	Prompts count value and starts count average print function (Section 12.20 on page 107) <i>If the accumulator is turned on, this softkey triggers an accumulation of both the entered count value and current weight</i>
Shrink	Displays keypad entry screen to enter shrink percentage as whole number <i>Example: To enter a shrink value of 15%, enter 15</i>
Clear Shrink	Defaults the current shrink value to 0
Clear Accumulator	Resets the accumulator
Print Accumulator	Prints data in accumulator format
Off	Sends Auxiliary Format 3 out of its configured destination port to deactivate the Stop and Go lights of a LaserLight Remote Display (Section 13.4 on page 113)

Table 4-25. Softkey Descriptions (Continued)

### User String Menu

This section provides a flow chart and descriptions for the User String menu.

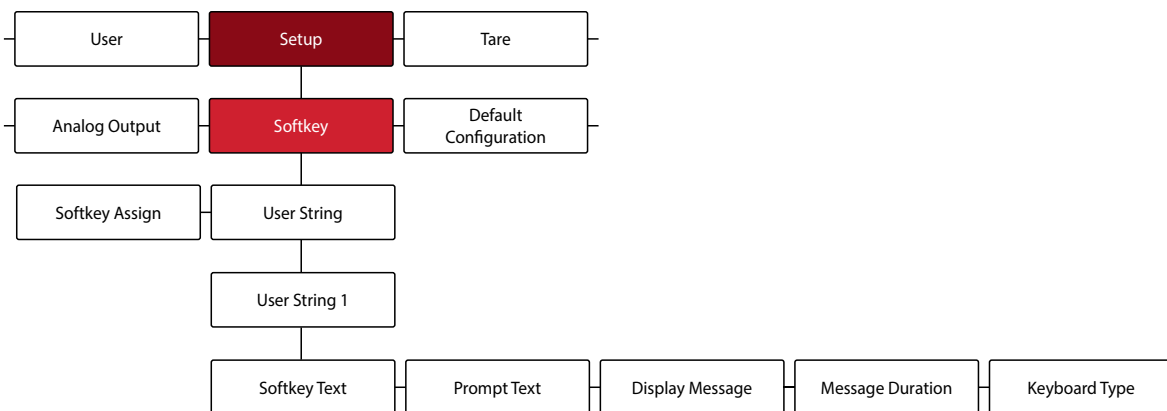


Figure 4-28. User String Menu

Parameter	Description
Softkey Text	Sets the text that displays on the User String softkey
Prompt Text	Sets the text that appears above the on-screen keyboard
Display Message	Sets the text that appears on the display
Message Duration	Determines whether the message is permanent or temporary
Keyboard Type	Determines whether the on screen keyboard that appears is alphanumeric or numeric

Table 4-26. User String Menu Parameters

## 4.6 Tare Menu

This section provides a flow chart and descriptions for the Tare menu.

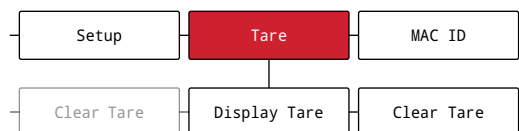


Figure 4-29. Tare Menu

Parameter	Description
Display Tare	Displays the current tare value (read only)
Clear Tare	Clears the current tare value

Table 4-27. Tare Menu Parameters

## 5.0 Split Mode Configuration

The 682 supports multi-range and multi-interval scales of either two or three ranges or intervals. The full scale capacity is the second range/interval when just Range 1 is set or the third range/interval when Range 1 and Range 2 are set.

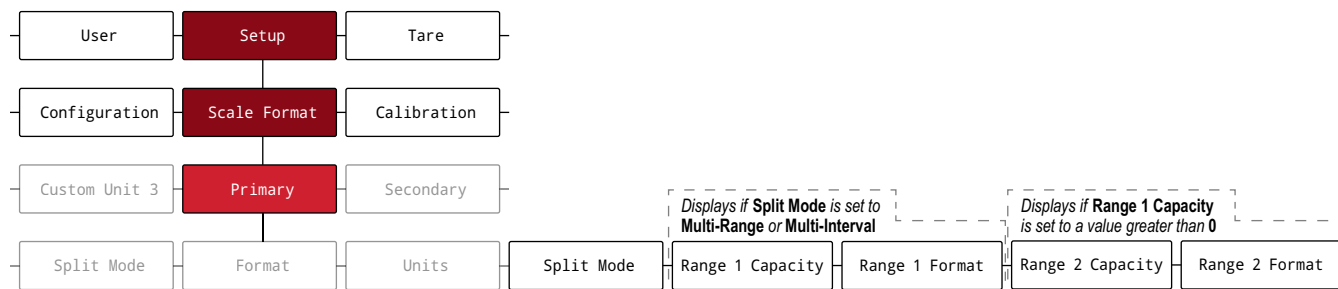


Figure 5-1. Setup – Scale Format Menu – Split Mode

Mode	Description
Multi-Range	Provides two or three ranges, each extending to the maximum capacity specified for each range; the scale display division changes as the applied weight increases, but does not reset to lower display divisions until the scale returns to center of zero
Multi-Interval	Divides the scale capacity into two or three partial weighing intervals, each with different display divisions; the intervals extend to the maximum capacity specified for each interval; the display divisions change with both increasing and decreasing loads
Off	Disables split mode

Table 5-1. Split Mode Options

Parameter	Description
Range 1 Capacity (MRMI)	Sets the capacity of Range 1 for the scale in primary units; this parameter must be set for <b>Range 2 Capacity</b> and <b>Range 2 Format</b> to display; <i>Enter value: 0.0-9999999.0, 0.0 (default)</i>
Range 1 Format	Sets the Range 1 units format (decimal point and display divisions); <i>Settings: 8888881 (default), 8888882, 8888885, 8888810, 8888820, 8888850, 8888100, 8888200, 8888500, 88.88881, 88.88882, 88.88885, 888.8881, 888.8882, 888.8885, 8888.881, 8888.882, 8888.885, 88888.81, 88888.82, 88888.85, 888888.1, 888888.2, 888888.5</i>
Range 2 Capacity (MRMI)	Sets the capacity of Range 2 for the scale in primary units; only displays if <b>Range 1 Capacity</b> is set to a value greater than 0; <i>Enter value: 0.0-9999999.0, 0.0 (default)</i>
Range 2 Format	Sets the Range 2 units format (decimal point and display divisions); only displays if <b>Range 1 Capacity</b> is set to a value greater than 0; <i>Settings: 8888881 (default), 8888882, 8888885, 8888810, 8888820, 8888850, 8888100, 8888200, 8888500, 88.88881, 88.88882, 88.88885, 888.8881, 888.8882, 888.8885, 8888.881, 8888.882, 8888.885, 88888.81, 88888.82, 88888.85, 888888.1, 888888.2, 888888.5</i>

**NOTE: In multi-range or multi-interval mode, the Format, Units and Capacity parameters define max range of the scale. If Range 1 Capacity is set and Range 2 Capacity is disabled (set to 0), range 2 is configured automatically. If Range 2 Capacity is set then range 3 is automatically configured.**

Table 5-2. Split Mode – Sub-Parameters

## 5.1 Configure a Multi-Range or Multi-Interval Scale

Access to *Setup* mode (Section 4.1 on page 40) is required.

1. Navigate to the Configuration menu within the Setup menu. Configuration displays.
2. Press . Scale Format displays.
3. Press . Primary displays.
4. Press . Format displays.
5. Press . Split Mode displays.
6. Press . The setting options for split mode displays.
7. Press and to select Multi-Range or Multi-Interval.
8. Press . Range 1 Capacity displays. See Section 5.0 on page 66 for more information on split mode.
9. Press . The current Range 1 weight value displays.
10. Use the numeric keypad to enter a new value, if necessary.
11. Press to accept value. Range 1 Format displays.
12. Press . The current Range 1 Format setting displays.
13. Use and to move to a new setting, if necessary.
14. Press to accept format setting. Range 2 Capacity displays.



**NOTE:** A Range 1 Capacity must be set for a Range 2 Capacity to appear as an option. The full scale capacity is the second range/interval when just Range 1 is set or the third range/interval when Range 1 and Range 2 are set.

15. Repeat previous steps for Range 2, if necessary.
16. Press to return to *Weigh* mode.

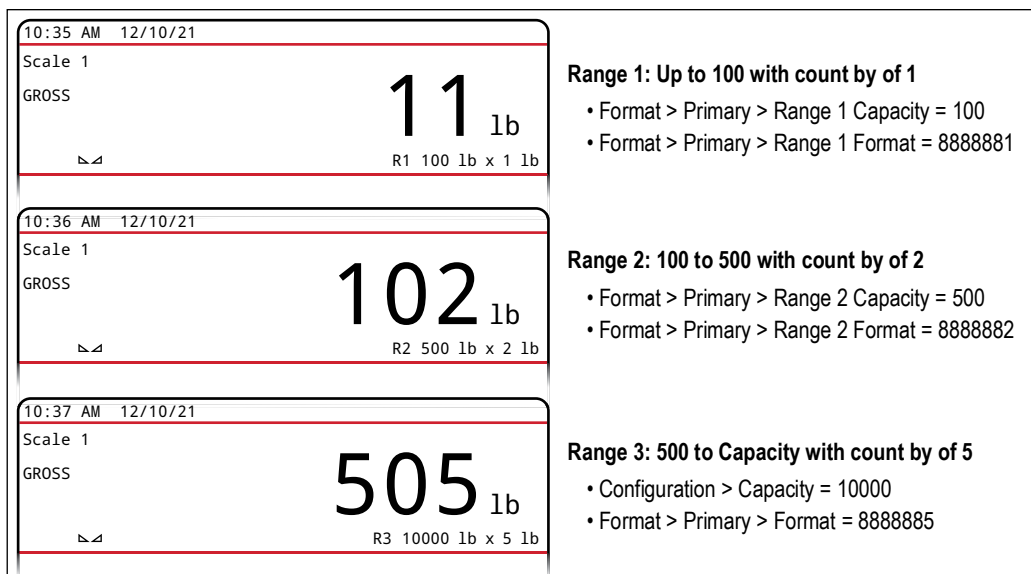


Figure 5-2. Split Mode Multi-Range Example



**NOTE:** When using Multi-Range, the last range/count by reached is held until returning to zero, even when descending through other ranges. When using Multi-Interval, range/count by changes both when ascending and descending.

## 6.0 Calibration

The 682 can be calibrated using the front panel and EDP commands. The following sections describe the procedures required for these calibration methods.

 **NOTE:** The 682 requires a Zero Calibration and Span Calibration to be calibrated. The Linear Calibration points are optional; they must fall between zero and span, but must not duplicate zero or span.

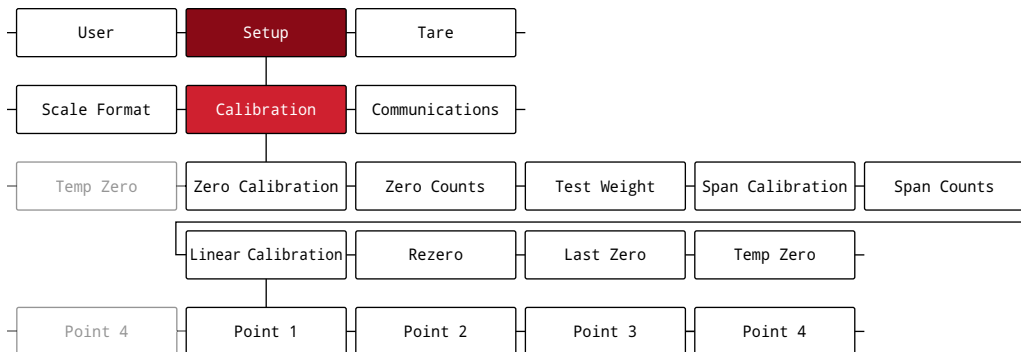




Figure 6-1. Setup – Calibration Menu








### 6.1 Front Panel Calibration


#### 6.1.1 Span Calibration


Use the following procedure to perform a standard span calibration on a connected scale. Access to *Setup* mode (Section 4.1 on page 40) is required.

1. Navigate to the Configuration menu within the Setup menu. Configuration displays.
2. Press  twice. Calibration displays.
3. Press . Zero Calibration displays.

 **NOTE:** See Section 6.2 on page 69 if the application requires a rezero, last zero or temporary zero.










4. Ensure there is no weight on the scale.
5. Press  to perform a zero calibration. Please Wait displays briefly and then Zero Calibration Complete displays.
6. Press . Zero Counts displays. See Section 4.5.3 on page 46 for more information on zero counts.
7. Press . Test Weight displays.
8. Press . The current test weight value displays.
9. Use the numeric keypad to enter a new value, if necessary.
10. Press  to accept value. Span Calibration displays and the indicator is ready for test weight.
11. Place the specified amount of test weight on the scale.
12. Press  to perform a span calibration. Please Wait displays briefly and then Span Calibration Complete displays.
13. Press . Span Counts displays. See Section 4.5.3 on page 46 for more information on span counts.

 **NOTE:** Span calibration is complete. To continue with a linear calibration, see Section 6.1.2 on page 69 before returning to Weigh mode.

14. Press  to return to Weigh mode.


## 6.1.2 Linear Calibration

Linear calibration points provide increased scale accuracy by calibrating the indicator at up to four additional points between the zero and span calibrations. Access to *Setup* mode (Section 4.1 on page 40) is required.

1. Complete steps 1–13 in Section 6.1.1 on page 68.
2. Press . Linear Calibration displays.
3. Press . Point 1 displays.
4. Press . Linear Point 1 Weight displays.
5. Press . The current test weight value for point 1 displays.
6. Use the numeric keypad to enter a new value, if necessary.
7. Press  to accept value. Calibrate Linear Point 1 displays and the indicator is ready for test weight.
8. Place the specified amount of test weight on the scale.
9. Press  to perform a linear point calibration. Please Wait displays briefly and then Point Calibration Complete displays.
10. Press . Linear Point 1 Counts displays. See Section 4.5.3 on page 46 for more information on linear point counts.
11. Press . Point 1 displays.
12. Press . Point 2 displays.
13. Repeat previous steps for points 2-4, if necessary.



**NOTE:** The linear calibration for a point is saved once point is calibrated.

14. Press  to return to *Weigh* mode.

## 6.2 Alternative Zero Calibrations

During a calibration, the zero value can be replaced with a temporary zero or last zero.

A rezero can be done after calibration. See below for information on alternative zeros.

### 6.2.1 Last Zero

This takes the last push-button zero in the system (from *Weigh* mode) and uses it as the new zero reference point, after which a new span calibration must be performed. This calibration cannot be performed when calibrating a scale for the first time.

A last zero calibration is typically used on truck scales to allow a scale verification to become a calibration without having to remove the test weights.

### 6.2.2 Temporary Zero

A temporary zero calibration temporarily zeros the displayed weight of a non-empty scale. After span calibration, the difference between the temporary zero and the previously calibrated zero value is used as an offset.

A temporary zero calibration is typically used on hopper scales to calibrate the span without losing the original zero calibration.

### 6.2.3 Rezero

A rezero calibration is needed to remove a calibration offset when hooks or chains are required to suspend the test weights.

Once a span calibration is complete, remove the hooks or chains and the test weights from the scale. With all the weight removed, a rezero calibration is used to adjust the zero and span calibration values.

### 6.3 EDP Command Calibration

Use the following instructions to calibrate the 682 using EDP commands. For information on the EDP commands of the 682, see [Section 12.0 on page 96](#). Access to *Setup* mode ([Section 4.1 on page 40](#)) is required.



**NOTE:** *The indicator must respond with OK after each step or the calibration procedure must be done again.*

*For commands ending with #s, s is the scale number (1).*

1. Put the indicator in *Setup* mode ([Section 4.1 on page 40](#)).
2. For a standard calibration, remove all weight from scale (except hooks or chains which are needed to attach weights).
3. Send the command **SC.WZERO#s** to perform a standard calibration of the zero point.
  - Send **SC.TEMPZERO#s** to perform a temporary zero calibration
  - Send **SC.LASTZERO#s** to perform a last zero calibration
4. Apply the span calibration weight to the scale.
5. Send the command **SC.WVAL#s=xxxxx**, where **xxxxx** is the value of the span calibration weight applied to the scale.
6. Send the command **SC.WSPAN#s** to calibrate the span point. Continue on to [step 7](#) to calibrate additional linear points, or proceed to [step 11](#).
7. Apply weight equal to the first linear point to the scale.
8. Send the command **SC.WLIN.Vn#s=xxxxx**, where **n** is the linear point number (1-4) and **xxxxx** is the exact value of the weight applied.
9. Send the command **SC.WLIN.Cn#s** to calibrate the linear point, where **n** is the linear point number (1-4).
10. Repeat [steps 7–9](#) for up to four total linear points.
11. If hooks or chains were used to attach the weights, remove all weight, including the hooks and chains, and send the command **SC.REZERO#s** to remove the zero offset.
12. Send the command **KSAVEEXIT** to return to *Weigh* mode.

## 7.0 Truck Modes

The truck in/out modes are used to handle multiple truck IDs and weights. Truck IDs can be up to 16 alphanumeric characters in length. Six available truck modes combine stored truck IDs, keyed tares and value swapping features in various ways.



**NOTE:** A microSD card must be installed in the memory card slot (J6) in order for the indicator to store truck IDs in a truck mode. The 682 indicator comes with an 8 GB microSD card installed.

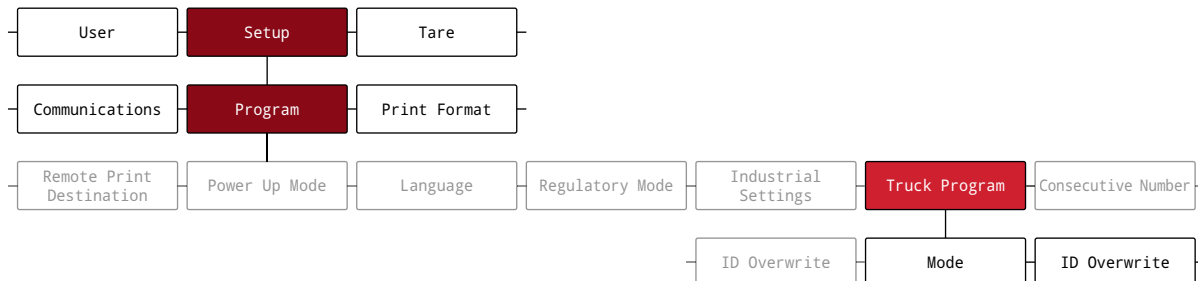


Figure 7-1. Program Menu – Truck Program

Mode	Stored IDs	Keyed Tares	Value Swapping
Mode 1	No	Yes	Yes
Mode 2	No	No	Yes
Mode 3	Yes	Yes	Yes
Mode 4	Yes	No	Yes
Mode 5	Yes	Yes	No
Mode 6	Yes	No	No
Off			

Table 7-1. Available Truck Modes

**Stored IDs** – Keeps a database of truck IDs and weigh-in weights in the indicator's memory. The indicator can automatically store up to 1,000 truck IDs and tares or it can clear the information after printing a weigh-out ticket. For example, if the same truck seldom crosses the scale, it may not be practical to save its truck ID and weigh-in weight. However, if that same truck crosses the scale many times each day, it's more convenient to store the information in the indicator memory and recall it when needed. Stored truck IDs and weights are available in modes 3, 4, 5 and 6.



**NOTE:** By default, Stored IDs can not be entered a second time for duplicate weigh-ins. The ID Overwrite parameter can be Enabled to allow duplicate Truck IDs to replace Stored IDs.

**Keyed Tares** – Allows manual entering of the tare weight using the numeric keypad and the **Tare** key. Keyed tares are available in modes 1, 3 and 5. To use keyed tares, an incoming truck must be empty at weigh-in, full at weigh-out.



**NOTE:** Some local regulations require the tare weight to be read from the scale. If so, don't use the keyed tares feature.

**Value Swapping** – Ensures that the lowest of the two associated weight values of a truck ID is used as the tare weight. For example, if a truck crosses the scale fully loaded at weigh-in, then unloads and crosses the scale empty at weigh-out, the indicator automatically assigns the lesser (empty truck) weight as the tare. Value swapping is available in modes 1, 2, 3 and 4.

### 7.1 Using the Truck Modes

Configuring a truck in/out mode requires access to *Setup* mode ([Section 4.1 on page 40](#)).

1. Navigate to the Configuration menu within the Setup menu. Configuration displays.
2. Press or until Program displays.
3. Press . Power Up Mode displays.
4. Press or until Truck Program displays.

5. Press . Mode displays.
6. Press . The current truck mode setting is highlighted.
7. Press or to navigate to the desired truck mode, if necessary.
8. Press to accept the highlighted truck mode.
9. Press twice to navigate back up to the Setup menu level. Program displays.
10. Press or until Softkey displays.
11. Press and configure softkeys to **Weigh In**, **Weigh Out** and **Truck Regs**. See [Section 3.4.19 on page 38](#) for procedure on configuring softkeys. These three softkeys are required when using the truck modes.



**NOTE:** Softkey 2 and Softkey 4 must be set to Blank in order to achieve the softkey arrangement in [Figure 7-2](#).

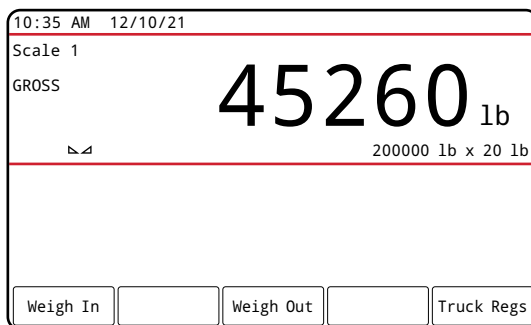


Figure 7-2. Truck Mode Softkeys

12. Once softkeys are configured, press to return to *Weigh* mode.

## 7.2 Using the Truck Register Display

The **Truck Regs** display is shown by pressing the **Truck Regs** softkey in *Weigh* mode. The display contains an alphabetical list of stored truck IDs, weigh-in weights (in primary units), and the time and date of the weigh-in transaction.

		Truck IDs	
ACME 155	:	45120 lb	10:50 AM 11/11/21
ACME 160	:	32240 lb	02:32 PM 12/09/21
Green 11	:	32320 lb	08:55 AM 10/14/21
RLWS 123	:	41420 lb	12:24 PM 10/28/21
Truck 01	:	34560 lb	09:08 AM 12/02/21

At the bottom of the display are five softkey buttons: Page Up, Page Down, Cancel, Delete, and Delete All.

Figure 7-3. Truck Register Display

Softkeys shown at the bottom of the **Truck Regs** display are described below.

- **Page Up** – Displays previous page of the truck register.
- **Page Down** – Displays next page of the truck register.
- **Cancel** – Exits to *Weigh* mode.
- **Delete** – Deletes the highlighted truck ID from the truck register.
- **Delete All** – Deletes all truck IDs from the truck register.

The truck register, for the highlighted entry, can be printed to an attached printer by pressing the **Print** key while the Truck Regs display is shown. The printed register uses the **Truck Format** print format ([Section 4.5.6 on page 56](#)).



## 7.3 Weigh-In Procedure

In modes 1 and 2, the indicator erases truck ID numbers and tare weights from memory after the transaction. In modes 3–6, the truck ID and weigh-in weight values are saved after the weigh-out ticket has been processed.

The general weigh-in procedure is as follows:

1. The empty truck moves onto the scale for weigh-in.
2. Press the **Weigh In** softkey. The keyboard truck ID entry screen displays.
3. Enter the truck ID (up to 16 characters) using the alphanumeric entry procedure ([Section 3.3.2 on page 31](#)).



**NOTE:** The numeric keypad can be used to enter numbers for truck IDs.

4. Press **✕ Cancel** softkey to exit without saving.  
- Or -  
Press **✓ Save** softkey to save and exit when the truck ID is correct.
5. Display returns to *Weigh* mode and the indicator prints a weigh-in ticket.  
ID 304812  
GROSS 15000 LB INBOUND  
01/14/2022 10:24 AM
6. Truck leaves the scale.

## 7.4 Weigh-Out Procedure

The general weigh-out procedure is as follows:

1. The loaded truck moves onto the scale for weigh-out.
2. If truck ID is known, press the **Weigh Out** softkey, enter the truck ID, and press **✓ Save** softkey.  
If truck ID is not known, press the **Truck Regs** softkey to view list of stored truck IDs ([Figure 7-3 on page 72](#)). Scroll to the correct truck ID, note the truck ID, then press the **Cancel** softkey to return to the *Weigh* mode. From *Weigh* mode, press **Weigh Out** softkey, key in the truck ID, then press **✓ Save** softkey.
3. Display returns to *Weigh* mode and the indicator prints a weigh-out ticket. In modes 1 and 2, the truck ID is deleted once the weigh-out ticket is processed.

## 7.5 Single-Transaction Tare Weights and IDs

One-time transactions are supported in all modes that can be configured to use stored Truck IDs (modes 3–6). This function allows one-time weighing of trucks without adding the truck ID and weigh-in weight to the permanent truck register.

To use this function, press the **Weigh In** or **Weigh Out** softkey, then enter a truck ID containing a decimal point. Truck IDs entered with a decimal point as part of the truck ID are erased from the truck register when the transaction is complete.

## 8.0 HTTP Web Server

The 682 web server allows for remote viewing of the current 682 *Weigh* mode values through a web browser. The web server also allows for the use of certain 682 function keys and the ability to view and update active setpoint values.

### 8.1 Access Procedure

Configuring the HTTP Web Server requires access to *Setup* mode ([Section 4.1 on page 40](#)).

1. Connect the 682 Ethernet port (J8) directly to a PC or through a network router or switch.



**NOTE: The web server is not available through Wi-Fi.**

2. Navigate to the Configuration menu within the Setup menu. Configuration displays.
3. Press . Serial displays.
4. Press or until Ethernet displays.
5. Press . Ethernet MAC ID displays.
6. Press . Http Server displays.
7. Press . The current setting for Http Server is highlighted. Make sure **On** is selected and press .
8. Press or until Enabled displays.
9. Press . The current setting for Enabled is highlighted. Make sure **On** is selected and press .
10. Press to return to *Weigh* mode to allow the indicator to initialize the updated settings.
11. Reenter the Setup menu in *Setup* mode and navigate to the Communications menu. Communications displays.
12. Press . Serial displays.
13. Press or until Ethernet displays.
14. Press . Ethernet MAC ID displays.
15. Press or until IP Address displays.
16. Press . The current IP Address displays.
17. Type the current IP Address into a web browser to access the 682 web server.
18. Press twice to return to *Weigh* mode.

## 8.2 Browser Display

This section provides an example of the 682 web server browser display and describes all the features and their functions.

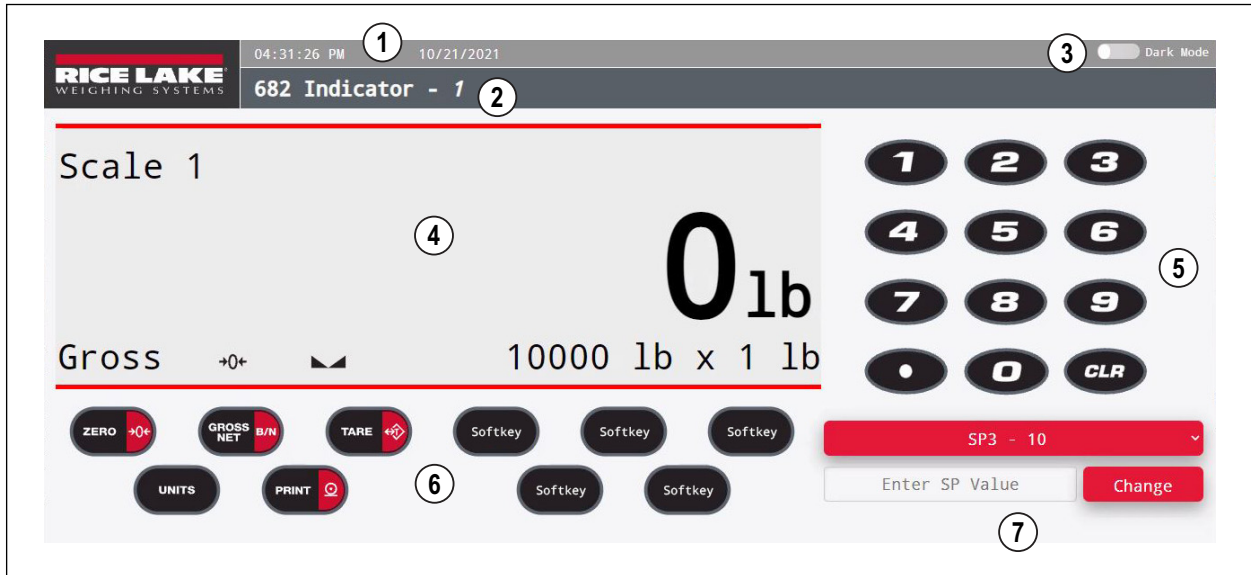


Figure 8-1. Web Server Browser Display

Item No.	Description
1	Current time and date
2	Unit ID location
3	Dark mode display option toggle; adjusts display for lowlight or nighttime viewing
4	Current 682 weight display area
5	Remote numeric keypad
6	Remote function keys and softkeys
7	Ability to view and update setpoint values if Access is set to On for the selected setpoint, otherwise selecting the Change button has no effect

Table 8-1. Web Server Display Descriptions



**NOTE:** Text that appears in the message display area of the 682 is not shown via the web server.

## 9.0 Wi-Fi & Bluetooth® Communications

The 682 is a Wi-Fi and/or Bluetooth® device. The following sections provide details on Wi-Fi and Bluetooth® communications and describe the procedures required to configure these features.

The 682 features a Lantronix® xPico 200 Series wireless module. Visit [www.lantronix.com](http://www.lantronix.com) to view the xPico 200 Series User Guide for detailed instructions on the module.



**NOTE:** The use of a web browser on a computer or handheld device is needed to access the wireless module's built-in Web Manager. See [Section 3.4.17 on page 37](#) to view the Wi-Fi and Bluetooth® MAC Addresses from the 682 display.

### Soft AP (Access Point) Details

- Name: **RLWS\_XXXXXX**
- Password: **PASSWORD**
- Configuration Page: **http://192.168.0.1**



**NOTE:** The Soft AP only shows up as a 5-GHz network. The connecting device must be capable of using the 5 GHz band to connect to the Soft AP. Setup → Communications → WiFi & Bluetooth → Enabled defaults to Off and must be set to WiFi, Bluetooth or Both to enable Wi-Fi & Bluetooth communications and allow the Soft AP to be available.

### 9.1 Bluetooth® Communications

To enable Bluetooth® for the 682 indicator, navigate to Setup → Communications → WiFi & Bluetooth → Enabled, and select Bluetooth or Both. This parameter is only accessible in Setup mode ([Section 4.1 on page 40](#)).

Once enabled, scan for available Bluetooth® devices on the device that is intended to be paired with the 682 and pair the intended Bluetooth® device with the 682 wireless module's Bluetooth® connection. The 682 wireless module's Bluetooth® device name is **RLWS\_XXXXXXXXXXXX**.



**NOTE:** The X's in the name represent the entire Bluetooth® MAC address.

### 9.2 Wi-Fi Communications

The 682 creates a Wi-Fi network that can be connected to with a computer or the location's network. Configuration of the wireless settings is done through the built-in Web Manager. The Web Manager can be accessed through the built-in Soft AP (Access Point). The Soft AP can be used to connect to a location's network using the Web Manager. In applications that don't have a local network to connect to or if the network is not in range, the Soft AP connection can also be used to talk to a 682 by connecting to IP 192.168.0.1, port 10001.

#### 9.2.1 Wi-Fi Setup

The following procedure is for setting up the Wi-Fi network using the wireless module's built-in Web Manager.

1. Power on the 682 indicator.
2. To enable the wireless module and specify wireless communications in the 682 menu:
  - In Setup mode ([Section 4.1 on page 40](#)), navigate to Setup → Communications → WiFi & Bluetooth → Enabled, and set to WiFi or Both.
  - Return to *Weigh* mode to allow the change to initialize.

- Scan for available Wi-Fi networks using a computer or handheld device and connect to the Soft AP. It might take a few attempts before the Soft AP appears on the computer or device. The Soft AP only shows up as a 5-GHz network.
  - Soft AP Name: **RLWS\_XXXXXX**
  - Soft AP Password: **PASSWORD**

**!** **IMPORTANT:** It is recommended to change default passwords to limit access and for security.

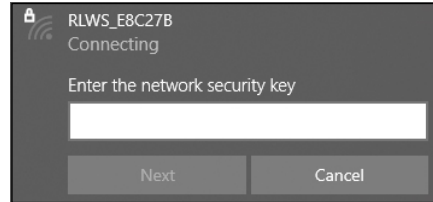


Figure 9-1.

**NOTE:** The X's in the name represent the last 6 digits of the Wi-Fi MAC address. The serial number on the wireless module's label is almost the same, other than the last digit being one number/character less than the Wi-Fi MAC address.

**FOR EXAMPLE:** If the module's serial number is "0080A3E8C27A", then the SSID would be "RLWS\_E8C27B". The MAC address is a Hexadecimal value, so the letter A follows the number 9, and this continues to F before incrementing the next most significant digit and returning to 0.

**NOTE:** The wireless module's serial number is the same as the Bluetooth® MAC address.

- Once connected to the Soft AP, use a web browser and enter **192.168.0.1** as the URL address and press **Enter**.

**NOTE:** Once connected to a network, a web browser on that network can connect to the Web Manager by simply navigating to the wireless module's IP Address (available on the Status page of the Web Manager).

- Enter the default login credentials for the Web Manager.
  - Username: **admin**
  - Password: **PASSWORD**

**!** **IMPORTANT:** It is recommended to change default passwords to limit access and for security.

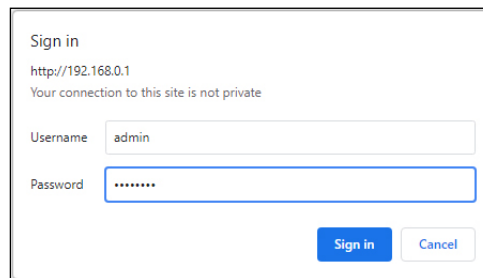


Figure 9-2.

- Press **Sign in**. The Web Manager loads in the browser and the **Status** page appears.
- Click **QuickConnect** at the top of the left navigation panel.



Figure 9-3.

8. A list of wireless networks appear. Click the network name intended to connect the wireless module's Wi-Fi network to.



**NOTE:** If the necessary network does not display, click the **Scan** button again. It may take a few tries to show the network. If the network is hidden, enter the network name in the box provided.

Network Name	BSSID	Ch	RSSI	Security Suite
ABC_Wifi_5G	3C:7C:3F:63:F2:84	36	-34	WPA2-CCMP
ABC_Wifi	3C:7C:3F:63:F2:81	4	-36	WPA2-CCMP
ABC_Wifi_5G	3C:7C:3F:63:EC:34	36	-64	WPA2-CCMP

Figure 9-4.



**NOTE:** The Web Manager provides notes and information related to the current page in the far right column. Descriptions for options and settings are also provided when hovering over the item in question.

9. The wireless network information page appears. Enter the network password (if applicable).



**NOTE:** Contact location's IT administrator to obtain network credentials as needed based on the security in place.

Figure 9-5.

10. Click **Submit** to apply and save the settings. A message displays at the top of the page to indicate if the new network's Profile saved successfully. It does not necessarily mean it is connected to the network.



**NOTE:** The **Apply** button only applies the settings for the current session, but does NOT save them.

11. To verify wireless module is connected to the location's network, click **Status** near the top of the left navigation panel.

Figure 9-6.



12. The **Status** page displays the network connections on the device under **Network Settings**.

Line	Network Settings	
Network	Interface ap0	
Radio	MAC Address:	02:80:A3:E8:C2:7B
Tunnel	State:	Up
User	SSID:	xPico250_E8C27A
WLAN Profiles	Security Suite:	WPA2
	IP Address:	192.168.0.1/24
	Interface eth0	
	MAC Address:	00:80:A3:E8:C2:7A
	State:	Down
	Interface wlan0	
	MAC Address:	00:80:A3:E8:C2:7B
	Connection State:	Connected
	Active WLAN Profile:	ABC_Wifi
	Hostname:	
	IP Address:	192.168.50.24/24
	Default Gateway:	192.168.50.1

Figure 9-7.

- **If Connected:** **Interface wlan0** is listed with **Connection State** showing **Connected** and the **IP Address** populated.



**NOTE:** The “/24” at the end of the IP Address indicates the number of bits set for the network subnet mask and is not part of the IP Address itself. There are 32 bits in a subnet mask and “/24” indicates the subnet mask is 255.255.255.0.

- **If Not Connected:** First try refreshing the browser to see if the information populates, then click **WLAN Profiles** at the bottom of the left navigation panel to change the network settings and try again.

13. Connecting to the wireless module’s server with a remote client is now possible.

14. Using a Terminal Emulation program, such as PuTTY, as a remote client connection to the wireless module’s server over Telnet is possible using the IP Address that was noted in [Step 12](#) and the Local Port number, which by default is 10001.

Basic options for your PuTTY session

Specify the destination you want to connect to

Host Name (or IP address)	Port
<input style="width: 95%;" type="text" value="192.168.1.24"/>	<input style="width: 95%;" type="text" value="10001"/>

Connection type:

Raw  
  Telnet  
  Rlogin  
  SSH  
  Serial

Figure 9-8. PuTTY Example



**NOTE:** If the card’s IP address changed and there is no longer access to the card through the location’s wireless network, connect to the Soft AP and use the Web Manager to learn the new IP Address.

For more information on features of this card, visit [www.lantronix.com](http://www.lantronix.com) to view the xPico 200 Series User Guide.

## 9.2.2 Server Configuration

The wireless module is configured to be a server by default, with the ability to accept the connection of a client to it.

- A **Server** is waiting to **Accept** a connection from a Client.
- A **Client** is looking to **Connect** to a remote Server (host).



**NOTE:** Even though a device can be set up for both, typically it is only set up as one or the other.

The following procedure shows where the wireless module's server settings are found using the Web Manager.



**NOTE:** Making changes to the Tunnel 1 Accept Configuration settings may impact the wireless module's connection to the location's network, established in Wi-Fi Setup (Section 9.2.1 on page 76).

1. Refer to Steps 1-6 in Section 9.2.1 on page 76 to sign in to the Web Manager.
2. Click **Tunnel** in the left navigation panel.

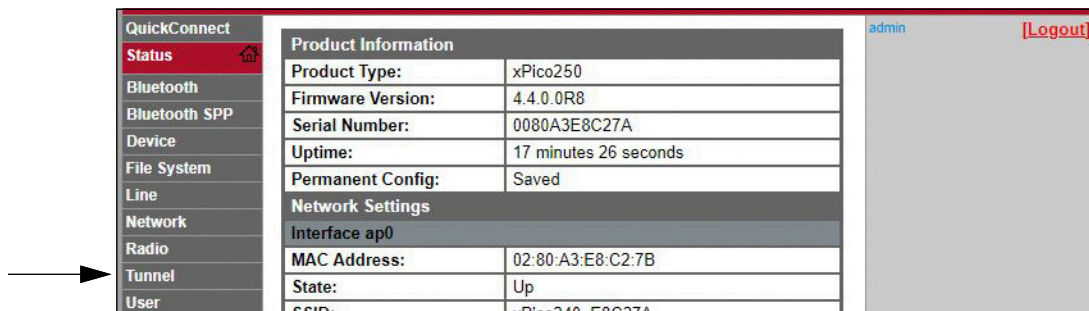


Figure 9-9.

3. Click **Accept** towards the top of the **Tunnel 1 Status** page.

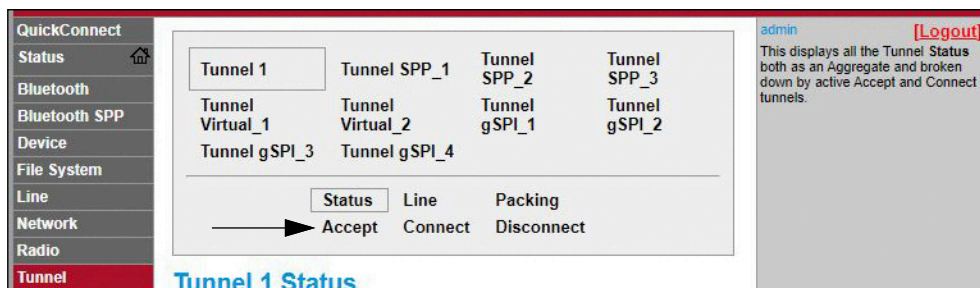


Figure 9-10.

4. Change the **Mode** and **Local Port** settings if needed.

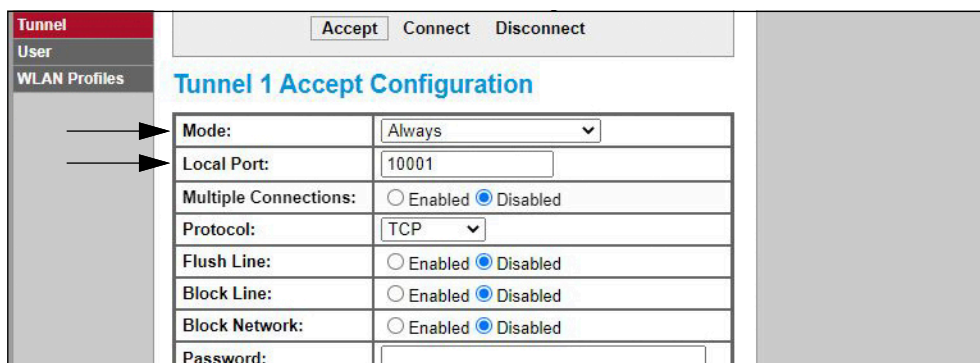


Figure 9-11.

5. Click **Submit** at the bottom of the page to apply and save the settings. A message displays at the top of the page to confirm the changes have been saved permanently.



### 9.2.3 Client Configuration

The wireless module is configured to be a server by default, with the ability to accept the connection of a client to it.

- A **Server** is waiting to **Accept** a connection from a Client.
- A **Client** is looking to **Connect** to a remote Server (host).

The following procedure is for configuring the wireless module as a client, using the Web Manager, to be able to connect the wireless module to an available server connection.

1. Refer to [Steps 1-6 in Section 9.2.1 on page 76](#) to sign in to the Web Manager.
2. Click **Tunnel** in the left navigation panel.

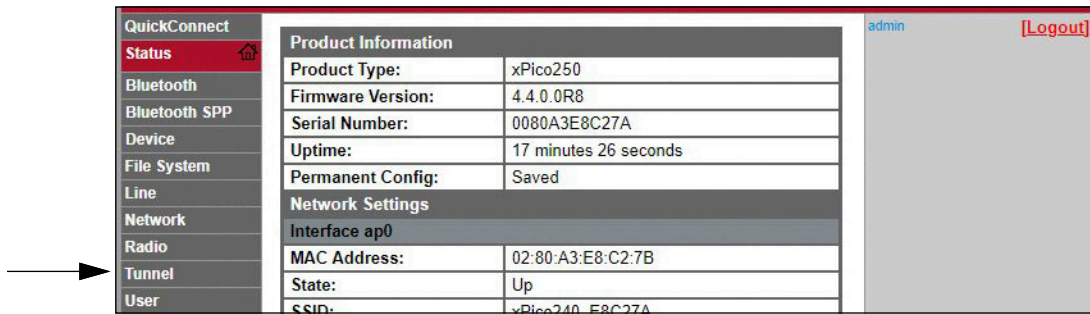


Figure 9-12.

3. Click **Connect** towards the top of the **Tunnel 1 Status** page.

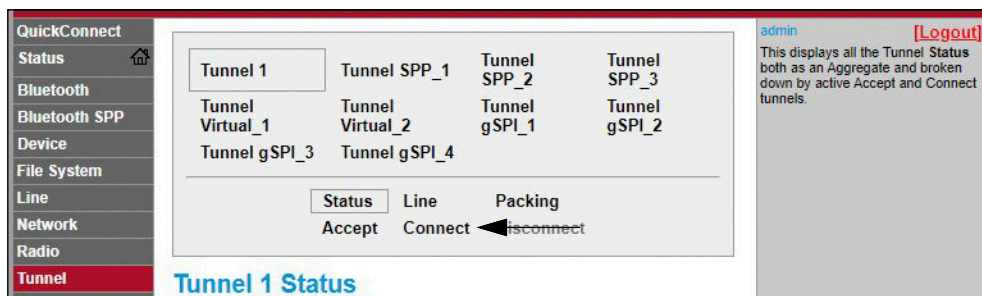


Figure 9-13.

4. Use the drop-down to change the **Mode** setting, and then click **[Edit]** to display available **Host 1** settings.



**NOTE:** The Web Manager provides notes and information related to the current page in the far right column. Descriptions for options and settings are also provided when hovering over the item in question.

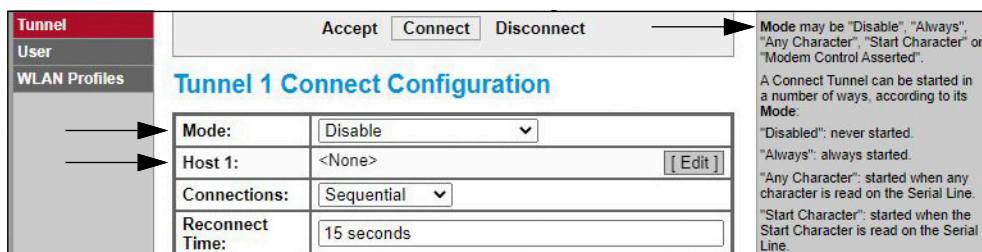


Figure 9-14.

- Set the **Address** and **Port** as needed to connect to the intended available server connection.

Figure 9-15.

- Click **Submit** at the bottom of the page to apply and save the settings. A message displays at the top of the page to confirm the changes have been saved permanently.



**NOTE:** While the wireless module's server is still available, it is necessary to adjust the server and client mode settings to allow both to function in unison. Even though a device can be set up for both, typically it is only set up as one or the other. Refer to the xPico 200 Series User Guide at [www.lantronix.com](http://www.lantronix.com) for more information.

## 9.2.4 Timeout Configuration

The wireless module has an optional Disconnect feature that can be configured to break a connection after a set amount of time. This feature applies to both server and client connections.

The following procedure shows where the wireless module's timeout setting is found using the Web Manager.

- Refer to [Steps 1-6 in Section 9.2.1 on page 76](#) to sign in to the Web Manager.
- Click **Tunnel** in the left navigation panel.

Figure 9-16.

- Click **Disconnect** towards the top of the **Tunnel 1 Status** page.

Figure 9-17.

4. Enter the desired value in milliseconds for the **Timeout** setting. A value entry of 0 disables the Disconnect feature.

Tunnel 1 Disconnect Configuration	
Stop Character:	<None>
Modem Control:	<input type="radio"/> Enabled <input checked="" type="radio"/> Disabled
Timeout:	<Disabled> milliseconds
Flush Line:	<input type="radio"/> Enabled <input checked="" type="radio"/> Disabled

Figure 9-18.

5. Click **Submit** at the bottom of the page to apply and save the settings. A message displays at the top of the page to confirm the changes have been saved permanently.

## 9.3 Wireless Module Specifications

The 682 features a Lantronix® xPico 200 Series wireless module. Visit [www.lantronix.com](http://www.lantronix.com) to view the latest list of technical specifications on the wireless module.

### Wireless Specifications

- IEEE 802.11 a/b/g up to 54 Mbps; 802.11 n (1×1) up to 150 Mbps
- 20 and 40 MHz channel width with optional SGI
- Dual Band 2.4 GHz and 5 GHz, Channels 1-13, UNII-1, 2a, 2e and 3
- Supports IEEE 802.11 d/h/i
- Bluetooth®/WLAN Coexistence
- 802.11r fast roaming

### Bluetooth® Specifications

- Compliant to Bluetooth® Core Specification version 4.2 (BR/EDR/Bluetooth® LE)
- Bluetooth® LE Central and Peripheral Roles
- Support for Generic Access Profile (GAP), Generic Attribute Profile (GATT), Device ID Profile
- Serial Port Profile (SPP)

### Data Communication

- TruPort® Serial Technology – TCP and UDP Server Mode, TCP and UDP Client Mode, Multi-host Connect; TLS Client and Server
- TruPort® Socket – Multi-host Client and Server Modes, HTTP(S), Sockets, TLS
- Authenticated SMTP Support – Send email directly from device

### Security and Authentication

- TruPort® Security Software
  - Secure Boot, Secure Firmware-Over-the-Air (FOTA) Updates
  - Secure Key Storage, Encrypted Configuration
  - Secure Connections with SSL/TLS, HTTPS
  - Software Controlled Network Service Ports Enable/Disable
  - Role Based Access Control
- AES/CCMP and TKIP encryption, WPA/WPA2 Personal
- WPA2 Enterprise (EAP-TLS, EAP-TTLS, EAP-PEAP, EAP-FAST)
- SSLv3/TLS 1.2 with PKI and X.509 Certificates (up to 4096-bit Keys)
- AES Algorithm, 256-bit, 192-bit, 128-bit

## Wireless Module Specifications Continued

### Management Interfaces

- Lantronix ConsoleFlow™ Cloud Software Platform, REST, MQTT
- Lantronix Discovery Protocol (77FE)
- Serial Port, Internal Web Server (HTTP/HTTPS)
- XML Configuration and XML Status (CLI, API)
- Secure Firmware Upgrade via HTTPS, ConsoleFlow™

### Protocol Support

- DHCP Client, Server (Soft AP), HTTP Server/Client
- IPv4, TCP/IP, UDP/IP, ARP, ICMP, Auto-IP, DNS
- SNMP v1/v2
- IPv6

### Wireless Features

- Concurrent Soft AP + STA (Client), Client, Soft AP
- Up to 5 simultaneous client connections to Soft AP interface
- Up to 4 in Concurrent Mode
- Connect to multiple WLAN networks, WLAN QuickConnect

### Certifications & Compliance

- Type Approvals: USA (FCC Part 15), Canada (IC RSS), EU (RED), Japan (MIC), China (SRRC), AU/NZS
- Safety: IEC 62368 EN 62368, EN 62311, UL 60950
- RoHS, REACH
- FCC ID: R68XPICO200
- Canada IC: 3867A-XPICO200
- CMIIT ID: 2017AJ6663(M)

## 10.0 Fieldbus Options Configuration

The 682 can be connected to SCT-2200 Fieldbus options to allow the 682 to communicate with a PLC with the necessary network protocol. The following sections provide details on Fieldbus communications and describe the procedures required to configure the available network protocols.

 **NOTE:** The SCT-2200 Fieldbus options must be running firmware version 1.25 or higher to communicate with the 682.

Part No.	Description
182591	Fieldbus, SCT-2200 EtherNet/IP Module
182592	Fieldbus, SCT-2200 PROFINET Module
212772	Fieldbus, SCT-2200 PROFIBUS DP Module
182596	Fieldbus, SCT-2200 DeviceNet Module
182597	Fieldbus, SCT-2200 CANopen Module
182598	Fieldbus, SCT-2200 EtherCAT Module
196694	Fieldbus, SCT-2200 Modbus TCP Module

Table 10-1. Available SCT-2200 Fieldbus Options for the 682 Indicator

### 10.1 Fieldbus Option Installation

1. Remove the backplate of the 682 ([Section 2.3 on page 14](#)).
2. Wire an RJ45 to blunt-end cable (not provided) to the J4 connector on the 682 CPU board ([Section 2.6 on page 22](#)).

 **NOTE:** Maximum RJ45 cable length is 4,000 ft.

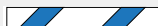
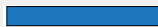
682 J4 Pins	SCT-2200 Fieldbus Module RJ45 Pins	Wire Color	Wire Diagram
1-3 (Not Used)	6-8 (Not Used)	–	–
4 (Y)	5 (B-)	White/Blue	
5 (Z)	4 (A+)	Blue	
–	1-3 (Not Used)	–	–

Table 10-2. Pin Assignments

3. Connect the other end of the cable to one of the RS-485 RJ45 ports on the SCT-2200 Fieldbus module.

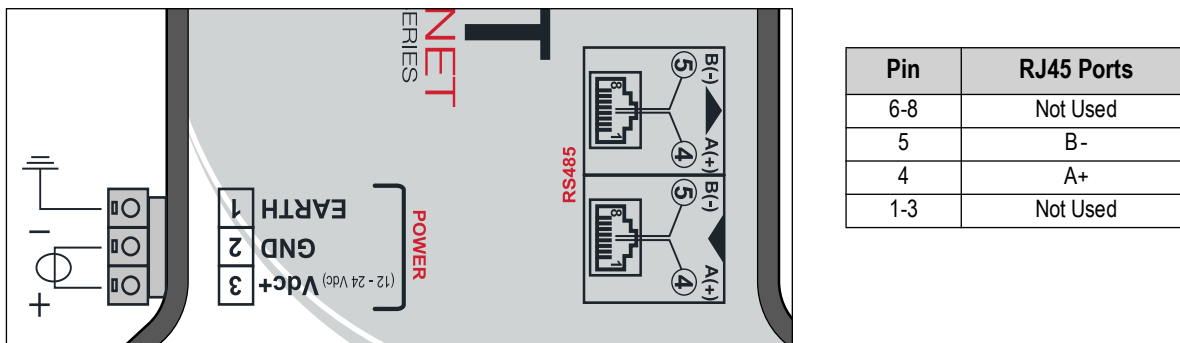









Figure 10-1. SCT-2200 Fieldbus Module Wiring








## 10.2 682 Fieldbus Configuration

The following procedure details how to configure the 682 for Fieldbus. Once the necessary 682 parameters are configured and installation complete, communication with the SCT-2200 Fieldbus option (firmware version 1.25 or higher) is ready.

1. Navigate to the Communications menu in *Setup* mode ([Section 4.1 on page 40](#)). *Communications* displays.
2. Press . *Serial* displays.
3. Press . *RS-232 Port 1* displays.
4. Press  or  until *RS-485* displays.
5. Press . *Trigger* displays.
6. Press . The current setting for the RS-485 Trigger is highlighted.
7. Ensure **Fieldbus** is selected and press .



**NOTE:** The *Trigger* parameter for the Serial Option Card Port would be set to *Fieldbus* when using a serial option card.

8. Press  twice. *Serial* displays.
9. Press . *Fieldbus* displays.
10. Press . *Network Protocol* displays.
11. Press . The current set Network Protocol is highlighted. Select needed protocol and press .
12. Press . *Protocol Parameters* displays. Edit the protocol specific parameters if necessary.
13. Press  to return to *Weigh* mode.



**IMPORTANT:** If the *Fieldbus* option is not communicating the correct data, adjust the *Byte/Word Swap* parameter in the indicator. See [Section 4.5.4.5 on page 52](#) for the *Fieldbus* menu structure and parameter descriptions.

### 682 Fieldbus Troubleshooting

After configuring the 682 parameters, cycle power to the module if it is wired to the 682.

**The EtherNet/IP, Modbus TCP, PROFINET, DevicNet, and CANopen modules have three status LEDs:**

- Green LED = Power — Green Power LED is on when there is power to the module
- Yellow LED = Status — Yellow Status LED is the RS-485 communication to the 682  
*If the module is not communicating, the yellow LED blinks rapidly for ~15 seconds then turns off for 1 second.*  
*If the module is communicating with the 682, the yellow LED blinks rapidly and does not turn off after ~15 seconds.*
- Red LED = Error — Red Error LED blinks until PLC is connected and communicating with the module, then turns off

**The PROFIBUS module has four status LEDs that function differently than the above modules:**

- Red LED = Power — Red Power LED stays on when there is power to the module
- Yellow LED = PROFIBUS — Yellow PROFIBUS LED stays on once module is connected to the PLC  
*If the module is not connected to the 682, the Yellow PROFIBUS LED blinks rapidly for ~15 seconds, then the Green RX LED blinks 3 times, followed by the Yellow TX LED blinking 3 times. This cycle repeats until module connects.*
- Green LED = RX — Green RX LED and Yellow TX LED blink alternately when module is communicating with the 682
- Yellow LED = TX — Yellow TX LED and Green RX LED blink alternately when module is communicating with the 682



## 10.3 EtherNet/IP Configuration



**NOTE:** The 682 must be configured for Fieldbus and EtherNet/IP:

- Setup → Communications → Serial → RS-485 or Serial Option Card Port set to Fieldbus
- Setup → Communications → Fieldbus → Network Protocol set to EtherNet/IP

### 10.3.1 EDS File Setup

This procedure walks through setting up the EtherNet/IP with an EDS file, preferred method. Use RXLogix to import EDS files.

1. Select the **Module Type Vendor Filter**.
2. Select **Hilsher GmbH**.
3. Select the catalog number **NIC 52-RE/EIS** and click Change.
4. Select **Exclusive Owner** from the drop down list and click **OK**.

### 10.3.2 Generic Module Setup

Use the following settings to setup a generic module.

- **Comm Format:** Data - DINT
- **Input:** Assembly Instance: 101 | Size: 33
- **Output:** Assembly Instance: 100 | Size: 32
- **Configuration:** Assembly Instance: 8 | Size: 0

## 10.4 PROFINET Configuration



**NOTE:** The 682 must be configured for Fieldbus and PROFINET:

- Setup → Communications → Serial → RS-485 or Serial Option Card Port set to Fieldbus
- Setup → Communications → Fieldbus → Network Protocol set to PROFINET

Download GSDML files from the Rice Lake Weighing Systems website and configure PROFINET based on [Figure 10-2](#).

Device overview						
Module	...	Rack	Slot	I address	Q address	...
▼ dini_1		0	0			...
▶ PN-IO		0	0 X1			...
64 Bytes Output_1		0	1		64...127	...
64 Bytes Output_2		0	2		128...191	...
		0	3			
		0	4			
64 Bytes Input_1		0	5	68...131		...
64 Bytes Input_2		0	6	132...195		...
		0	7			
		0	8			

Figure 10-2. PROFINET Device Overview



**NOTE:** The following sections apply for both EtherNet/IP and PROFINET.

## 10.5 Data From the PLC to the Indicator

Register No.	Data Registers	Byte Order	Byte No
0	Command Register	3	0
		2	1
1		1	2
		0	3
2	Parameter 1	3	4
		2	5
3		1	6
		0	7
4	Parameter 2	3	8
		2	9
5		1	10
		0	11
6	Parameter 3	3	12
		2	13
7		1	14
		0	15
8	Capacity	3	16
		2	17
9		1	18
		0	19
10	Units	3	20
		2	21
11		1	22
		0	23
12	Format	3	24
		2	25
13		1	26
		0	27
14	Calibration Point	3	28
		2	29
15		1	30
		0	31
16	Calibration Weight	3	32
		2	33
17		1	34
		0	35

Table 10-3. PLC to Indicator Data



## 10.5.1 Commands

Command	Decimal	Description
No Command	0	No action
Zero Scale	1	Zero the scale
Tare Scale	2	Tare the current weight if parameter 1=0, otherwise tare the value that is in parameter 1
Clear Tare	3	Clear a tare if one exists
Display Net Mode	4	Switch the scale from gross mode to net mode
Display Gross Mode	5	Switch the scale from net mode to gross mode
Write Setpoint	10	Parameter 1 = setpoint # parameter 2 = value
Read Setpoint	11	Parameter 1 = setpoint #
Read IO Points	12	Parameter 1 = IO slot number
Set Output On	24	Parameter 1 = slot parameter 2 = bit
Set Output Off	25	Parameter 1 = slot parameter 2 = bit
Write Setup	27	Write calibration settings and enter calibration mode
Restart Instrument	34	Restarts the indicator
Perform Zero Calibration	35	Performs a zero calibration
Perform Span Calibration	36	Performs a span calibration
Point Calibration	37	Point value found in parameter 1 (1-3)
Save Calibration	38	Save the calibration and exit calibration mode
Abort Calibration	39	Aborts a calibration and clears any errors
Keyboard Enable/Disable	40	Disable keys (parameter 1 = 0) Enable keys (parameter 1 = 1)
Read Accumulator	41	Multivalue 1 = returned accumulator value

Table 10-4. Command Values

## 10.6 Data From the Indicator to the PLC



**NOTE:** For EtherNet/IP options ONLY, if a generic module is setup, Header information occupies the first four bytes of data and pushes other data registers down.

Register No.	Data Registers	Byte Order	Byte No
0	Gross Weight	3	0
		2	1
1		1	2
		0	3
2	Net Weight	3	4
		2	5
3		1	6
		0	7
4	Scale Status	3	8
		2	9
5		1	10
		0	11
6	Onboard Digital I/O Status	3	12
		2	13
7		1	14
		0	15
8	Last Command Processed	3	16
		2	17
9		1	18
		0	19
10	Command Status	3	20
		2	21
11		1	22
		0	23
12	Calibration Status	3	24
		2	25
13		1	26
		0	27
14	Multi-use Value 1	3	28
		2	29
15		1	30
		0	31
16	Multi-use Value 2	3	32
		2	33
17		1	34
		0	35

Table 10-5. Indicator to PLC Data

### 10.6.1 Onboard Digital I/O Status

Bit	Description	Bit Status	
0	Digital I/O Bit	0 = Off	1 = On
1			
2			
3			
4-31	Future Use		

Table 10-6. Onboard Digital I/O Status

### 10.6.2 Calibration Status

Value	Description
0	Calibration not started
1	Calibration Acquisition in process
2	Calibration Acquisition OK
3	Calibration error

Table 10-7. Calibration Status

### 10.6.3 Command Status

Bytes	Description
0-3	Current command status result

Table 10-8. Command Status

The following values named **Result of last command received**, needs updating after the **last command processed** value is updated.

Value	Description
0	Command successfully performed
1	Not a valid command
2	General error; Trying to tare or zero while scale is in motion
3	Setpoint number does not exist; When trying to read or write to a setpoint but the setpoint value does not exist
4	Setpoint Kind set to OFF; When trying to read or write to a setpoint, but that setpoint is not configured
5	Setpoint not enabled; When trying to read or write to a setpoint but the setpoint is not enabled
6	Invalid IO; When trying to set any output on or off and that output is not configured
7	Not in <i>Setup</i> mode; When trying to use write setup, zero calibration, span calibration, point calibration, save calibration or abort calibration commands
8	Wrong command; Non-calibration command used during calibration
9	Invalid unit selection
10	Invalid decimal selection
11	Invalid display division selection
12	Calibration point out of range (1–4)
13	Invalid grads value
14	Calibration not allowed for MRMI or serial scale
15	Calibration weight out of range
16	Accumulator is not enabled
17	Audit trail is not enabled; Check the jumper to see that it is in the correct position

Table 10-9. Command Descriptions

## Unit Values

Value	Unit
0	Use configured unit
1	Lb
2	Kg
3	Oz
4	Tn
5	T
6	G
7	None

Table 10-10. Unit Values

## Decimal Point Values

Value	Decimal Point
0	Use configured decimal point
1	88.88881
2	88.88882
3	88.88885
4	888.8881
5	888.8882
6	888.8885
7	8888.881
8	8888.882
9	8888.885
10	88888.81
11	88888.82
12	88888.85
13	888888.1
14	888888.2
15	888888.5
16	8888881
17	8888882
18	8888885
19	8888810
20	8888820
21	8888850
22	8888100
23	8888200
24	8888500

Table 10-11. Decimal Point Values

## 10.6.4 Scale Status

Bit	Description	Bit Status	
0	Net Weight Polarity	0 = Positive	1 = Negative
1	Gross Weight Polarity		
2	Weight Stability	0 = Stable	1 = Motion
3	Underload Condition	0 = OK	1 = Under
4	Overload Condition	0 = OK	1 = Under
5	Push Button Tare Condition	0 = No	1 = Yes
6	Keyed Tare Condition	0 = No	1 = Yes
7	Gross Center of Zero	0 = COZ**	1 = COZ**
8	Display Mode	0 = Net	1 = Gross
9	Current Units	0 = Primary	1 = Other
10	Heartbeat - delay of 500 ms between on and off	0 = Off	1 = On
11	Scale Error	0 = Error	1 = OK
12	Accumulator Weight Polarity	0 = Positive	1 = Negative
12-31	Future Use		

\*\* Center of Zero

Table 10-12. Status Descriptions

## 10.6.5 Scale Error



**NOTE:** The scale error bit is always set to 1 unless one of the following errors occurs. At that time, the error bit is set to 0 until the error is cleared.

Error Condition
Configuration signature error
General configuration checksum error
Load cell data checksum error
Backup battery voltage low
Battery backed memory corrupt
Load cell A/D error
Tare data checksum error
Accumulator overflow error
Unable to write to non-volatile memory

Table 10-13. Error Conditions

## 10.7 Standard Calibration Process

Refer to [Table 10-3 on page 88](#) for parameter data information and [Table 10-4 on page 89](#) for descriptions of calibration commands. See [Section 10.6.2 on page 91](#) and [Section 10.6.3 on page 91](#) for possible command responses during the calibration process.

The standard calibration process requires access to *Setup* mode ([Section 4.1 on page 40](#)).

1. Set Capacity, Units and Format parameter data values ([Table 10-3 on page 88](#)).
2. Send command 27 to write Capacity, Units and Format parameter data values.



**NOTE:** No external button presses are needed to put the indicator into calibration mode with command 27 as long as the Audit Jumper is in the ON position ([Section 4.1.1 on page 40](#)).

3. Remove all weight from the scale.
4. Send command 35 to perform a zero calibration.
5. Set the Calibration Weight parameter data value to the needed span weight.
6. Set the Calibration Point parameter data value to 1.
7. Place the specified calibration weight on the scale.
8. Send command 36 to perform a span calibration.
9. Send command 38 to save and exit calibration mode.

## 11.0 Revolution

The Revolution utility provides a suite of functions used to support configuration, calibration, customization and backup of the 682 software.

Calibration values and scale configuration can both be saved and restored to the 682 using Revolution.



**NOTE:** For system requirements visit the Revolution product page on [Rice Lake Weighing Systems website](#).

### 11.1 Connecting to the Indicator

Connect the PC serial port to a 682 comm port, then click **Connect** in the toolbar. Revolution attempts to establish communications to the indicator. If communication settings need to be adjusted, select **Options...** from the Tools menu.

#### Downloading to the Indicator

The **Send Configuration to Device** function in the Revolution Communications menu allows a Revolution configuration file (with or without scale calibration data) or ticket formats to be sent/downloaded to a connected indicator in *Setup* mode.

The **Send Section to Device** function in the Communications menu allows the download of only the currently displayed object, such as a scale configuration.

Because less data is transferred using the **Send Section to Device**, it is typically faster than a full configuration download, but there is an increased possibility the download fails due to dependencies on other objects. If the download fails, try performing a complete download using the **Send Configuration to Device** function.

#### Uploading Configuration to Revolution

The **Get Configuration from Device** function in the Revolution Communications menu allows the existing configuration of a connected indicator to be saved to a file on the PC. Once saved, the configuration file provides a backup which can be quickly restored to the indicator if needed. Alternatively, the file can be edited within Revolution and sent back to the indicator.

### 11.2 Saving and Transferring Data



**NOTE:** Revolution has a module to save and transfer data. It is the preferred method over using ProComm or Hyper Terminal.

#### 11.2.1 Saving Indicator Data to a PC

Configuration data can be saved to a computer connected to the selected port. The PC must be running a communications program such as *PROCOMMPLUS*®.

When configuring the indicator, ensure the values set for the baud and bits parameters on the serial menu match the baud rate, bits and parity settings configured for the serial port on the PC.

To save all configuration data, first put the communications program into data capture mode, then place the indicator in *Setup* mode and send the DUMPALL command to the indicator. The 682 responds by sending all configuration parameters to the PC as ASCII-formatted text.

#### 11.2.2 Downloading Configuration Data from PC to Indicator

Configuration data saved on a PC or disc can be downloaded from the PC to an indicator. This procedure is useful when a number of indicators with similar configurations are set up or when an indicator is replaced.

To download configuration data, connect the PC to the selected port as described in [Section 11.2.1](#). Place the indicator in *Setup* mode and use the PC communications software to send the saved configuration data to the indicator. When transfer is complete, calibrate the indicator as described in [Section 6.0 on page 68](#).

### 11.3 Updating Firmware

Revolution is used to update the firmware of the 682 indicator. The link to begin this process is available on the Revolution home screen. Updating the firmware defaults the configuration settings.

## 12.0 EDP Commands

The 682 indicator can be controlled by a personal computer connected to one of the indicator communication ports. Control is provided by a set of commands which can simulate front panel key press functions, return and change setup parameters, and perform reporting functions. The commands provide the capability to print configuration data or to save data to an attached personal computer. This section describes the EDP command set and procedures for saving and transferring data using the communication ports. The EDP command set is divided into several groups.

When the indicator processes a command, it either responds with a value (for reporting commands, or when querying parameter settings), or with the message **OK**. The **OK** response verifies the command was received and has been executed. If the command is unrecognized, the indicator responds with **?? invalid command**. If the command cannot be executed in the current mode, the indicator responds with **?? invalid mode**. If the command is recognized, but the value is out of range or an invalid type, the indicator responds with **??** followed by the type and the range.

### 12.1 Key Press Commands

Key press serial commands simulate pressing keys on the front panel of the indicator. These commands can be used in both setup and *Weigh* mode. Several of the commands serve as pseudo keys, providing functions which are not represented by a key on the front panel.

For example, to enter a 15 lb tare weight using serial commands:

1. Type **K1** and press **Enter** (or **Return**).
2. Type **K5** and press **Enter**.
3. Type **KTARE** and press **Enter**.

Command	Function
KZERO	In <i>Weigh</i> mode, this command acts like pressing the <b>Zero</b> key
KGROSSNET	In <i>Weigh</i> mode, this command acts like pressing the <b>Gross/Net</b> key
KGROSS	Displays Gross mode (pseudo key)
KNET	Displays Net mode (pseudo key)
KTARE	In <i>Weigh</i> mode, this command acts like pressing the <b>Tare</b> key
KUNITS	In <i>Weigh</i> mode, this command acts like pressing the <b>Units</b> key
KPRIM	Displays primary units (pseudo key)
KSEC	Displays secondary units (pseudo key)
KTER	Displays tertiary units (pseudo key)
KPRINT	In <i>Weigh</i> mode, this command acts like pressing the <b>Print</b> key
KSOFT1-5	In <i>Weigh</i> mode, this command acts like pressing the associated softkey
KPRINTACCUM	Prints the accumulator value
KDISPACCUM	Displays the accumulator value
KDISPTARE	Displays the tare value
KCLR	In <i>Weigh</i> mode, this command acts like pressing the <b>Clear</b> key
KCLRNCN	Clears consecutive number
KCLRRTAR	Clears the tare from the system (pseudo key)
KLEFT	In <i>Setup</i> mode, this command moves <b>Left</b> in the menu
KRIGHT	In <i>Setup</i> mode, this command moves <b>Right</b> in the menu
KUP	In <i>Setup</i> mode, this command moves <b>Up</b> in the menu
KDOWN	In <i>Setup</i> mode, this command moves <b>Down</b> in the menu
KEXIT	In <i>Setup</i> mode, this command exits to <i>Weigh</i> mode
KSAVE	In <i>Setup</i> mode, this command saves the current configuration
KSAVEEXIT	In <i>Setup</i> mode, this command saves the current configuration and exits to <i>Weigh</i> mode
KTIME	Displays the Set System Time screen
KDATE	Displays the Set System Date screen
KTIMEDATE	Displays the Set System Time screen
KCLRACCUM	Clears the accumulator

Table 12-1. Key Press Commands



Command	Function
Kn	This command acts like pressing numbers 0 (zero) through 9
KDOT	This command acts like pressing the decimal point (.)
KENTER	This command acts like pressing the <b>Enter</b> key
KLOCK=x	In <i>Weigh</i> mode, this command locks specified front panel key; x = KPRINT, KUNITS, KTARE, KGROSSNET, KZERO, K0-K9, KDOT, KCLEAR (example: to lock the <b>Z</b> ero key, enter KLOCK=KZERO)
KUNLOCK=x	In <i>Weigh</i> mode, this command unlocks specified front panel key; x = KPRINT, KUNITS, KTARE, KGROSSNET, KZERO, K0-K9, KDOT, KCLEAR (example: to unlock the <b>P</b> rint key, enter KUNLOCK=KPRINT)

Table 12-1. Key Press Commands (Continued)

## 12.2 Reporting Commands

Reporting commands send specific information to the communications port. The commands listed in Table 12-2 can be used in either *Setup* mode or *Weigh* mode.

Command	Function
DUMPALL	Returns a list of all parameter values
DUMPAUDIT	Returns the Audit Trail information
KDUMPAUDIT	Returns the Audit Trail information on the same port which the EDP command was sent
AUDIT.LRVERSION	Returns the legally relevant firmware version
AUDIT.CONFIG	Returns the number of times configuration has changed
AUDIT.CALIBRATE	Returns the number of calibrations
AUDITJUMPER	Returns the position of the audit jumper: OK (if the audit jumper is ON) or ?? (if the audit jumper is OFF)
SPDUMP	Returns a list of the setpoint parameter values
VERSION	Returns the installed firmware version
FIELDBUS.VERSION	Returns the connected Fieldbus module's firmware version; returns V0.00.00 if no Fieldbus module is connected
BUILD	Returns the firmware version and build number
HARDWARE	Returns the option card installed
HWSUPPORT	Returns the CPU board part number
RTCBATTERYSTATUS	Returns the status of the real time clock battery: GOOD or BAD

Table 12-2. Reporting Commands

## 12.3 SD Card Commands

The following commands can be used to store or restore a backup copy of the indicator configuration to a microSD card. Indicator must be in *Setup* mode.



**NOTE:** A microSD card must be installed when using SD Card commands to back up or restore indicator configuration.

Command	Function
SDCARD.STORE	Store (back up) the current configuration to the installed microSD card; Answers OK if successful
SDCARD.LOAD	Loads a stored backup configuration from the installed microSD card; Answers OK if successful

Table 12-3. Reset Configuration Command



**NOTE:** The microSD card only functions with the 682. It is not formatted in FAT32 and will not be recognized by a PC. Ensure indicator firmware versions match before transferring a microSD card from one indicator to another.

## 12.4 Reset Configuration Command

The following command can be used to reset the configuration parameters of the 682.

Command	Function
RESETCONFIGURATION	Restores all configuration parameters to default values ( <i>Setup</i> mode only)

Table 12-4. Reset Configuration Command



**NOTE:** All scale calibration settings are lost when the **RESETCONFIGURATION** command is run.

## 12.5 Scale Parameter Setting Commands

Parameter setting commands allow the current value for a configuration parameter to be displayed or changed.

Current configuration parameter settings can be displayed in *Setup* mode or *Weigh* mode using the following syntax:

command<ENTER>

Most parameter values can be changed in *Setup* mode only; setpoint parameters listed in [Table 12-15 on page 104](#) can be changed when in normal *Weigh* mode.



**NOTE:** The user must stop the current batch for new values to take effect.

Use the following command syntax when changing parameter values: command=value<ENTER>, where **value** is either a number or a parameter value. Use no spaces before or after the equal (=) sign. If an incorrect command is typed or an invalid value is specified, the indicator returns ?? followed by the error message.

*Example: to set the motion band parameter on Scale #1 to 5 divisions, type the following:*

SC.MOTBAND#1=5<ENTER>

To return a list of the available values for parameters with specific values, enter the command and equal sign, followed by a question mark (command=?<ENTER>). The indicator must be in *Setup* mode to use this function.

After changes are made to configuration parameters using EDP commands, use the **KSAVE** or **KSAVEEXIT** commands to commit the changes to memory.

Command	Description	Values
SC.CAPACITY#n	Scale capacity	0.0000001–9999999.0, <b>10000.0</b> (default)
SC.ZTRKBND#n	Zero track band (in display divisions)	0.0–100.0, <b>0.0</b> (default)
SC.ZRANGE#n	Zero range (%)	0.0–100.0, <b>1.9</b> (default)
SC.SPLIT#n	Enables Multi-Range or Multi-Interval modes	<b>OFF</b> (default), MULTIRANGE, MULTIINTERVAL
SC.RANGE1#n SC.RANGE2#n	Sets the capacity of Range 1-2 for the scale in primary units	0.0–9999999.0, <b>0.0</b> (default)
SC.RANGE1.FMT#n SC.RANGE2.FMT#n	Sets the Range 1-2 units format (decimal point and display divisions)	8888100, 8888200, 8888500, 8888810, 8888820, 8888850, <b>8888881</b> (default), 8888882, 8888885, 888888.1, 888888.2, 888888.5, 88888.81, 88888.82, 88888.85, 8888.881, 8888.882, 8888.885, 888.8881, 888.8882, 888.8885, 88.88881, 88.88882, 88.88885
SC.MOTBAND#n	Motion band (in display divisions)	0–100, <b>1</b> (default)
SC.SSTIME#n	Standstill time (in 0.1 second intervals; 10 = 1 second)	0–600, <b>10</b> (default)
SC.SENSE#n	Sets the type of load cell cable connected	<b>4-WIRE</b> (default), 6-WIRE
SC.OVERLOAD#n	Overload	<b>FS+2%</b> (default), FS+1D, FS+9D, FS
SC.WMTTHR#n	Weighment threshold	0.0–9999999.0, <b>1000.0</b> (default)
SC.NUMWEIGH#n	Number of weighments (read only)	0–4294967295
SC.MAX_WEIGHT#n	Maximum weighment (read only)	–9999999–9999999
SC.MAX_DATE#n	Date of maximum weighment (read only)	Up to 25 alphanumeric characters
For commands ending with #n, n is the scale number (1)		

Table 12-5. Scale Parameter Setting Commands

Command	Description	Values
SC.DIGFLTR1# <i>n</i> SC.DIGFLTR2# <i>n</i> SC.DIGFLTR3# <i>n</i>	Number of A/D samples averaged for the individual stages (1-3) of the three stage digital filter	1, 2, 4 (default), 8, 16, 32, 64, 128, 256
SC.DFSENS# <i>n</i>	Digital filter cutout sensitivity	<b>2OUT</b> (default), 4OUT, 8OUT, 16OUT, 32OUT, 64OUT, 128OUT
SC.DFTHR# <i>n</i>	Digital filter cutout threshold	<b>NONE</b> (default), 2D, 5D, 10D, 20D, 50D, 100D, 200D, 250D
SC.RATLTRAP# <i>n</i>	Rattletrap filtering	<b>OFF</b> (default), ON
SC.SMPRAT# <i>n</i>	Scale A/D sample rate	6.25HZ, 7.5HZ, 12.5HZ, 15HZ, 25HZ, <b>30HZ</b> (default), 50HZ, 60HZ, 100HZ, 120HZ
SC.PWRUPMD# <i>n</i>	Power up mode	<b>GO</b> (default), DELAY
SC.TAREFN# <i>n</i>	Tare function	<b>BOTH</b> (default), KEYED, NOTARE, PBTARE
SC.PRI.FMT# <i>n</i>	Primary units format (decimal point and display divisions)	8888100, 8888200, 8888500, 8888810, 8888820, 8888850, <b>8888881</b> (default), 8888882, 8888885, 888888.1, 888888.2, 888888.5, 88888.81, 88888.82, 88888.85, 8888.881, 8888.882, 8888.885, 888.8881, 888.8882, 888.8885, 88.88881, 88.88882, 88.88885
SC.PRI.UNITS# <i>n</i>	Primary units	<b>LB</b> (default), KG, OZ, TN, T, G, NONE
SC.SEC.FMT# <i>n</i>	Secondary units format (decimal point and display divisions)	8888100, 8888200, 8888500, 8888810, 8888820, 8888850, 8888881, 8888882, 8888885, 888888.1, 888888.2, <b>888888.5</b> (default), 88888.81, 88888.82, 88888.85, 8888.881, 8888.882, 8888.885, 888.8881, 888.8882, 888.8885, 88.88881, 88.88882, 88.88885
SC.SEC.UNITS# <i>n</i>	Secondary units	LB, <b>KG</b> (default), OZ, TN, T, G, CUSTOM1, CUSTOM2, CUSTOM3, NONE
SC.SEC.ENABLED# <i>n</i>	Enable the Secondary Units	<b>ON</b> (default), OFF
SC.TER.FMT# <i>n</i>	Tertiary units format (decimal point and display divisions)	8888100, 8888200, 8888500, 8888810, 8888820, 8888850, 8888881, 8888882, 8888885, 888888.1, 888888.2, <b>888888.5</b> (default), 88888.81, 88888.82, 88888.85, 8888.881, 8888.882, 8888.885, 888.8881, 888.8882, 888.8885, 88.88881, 88.88882, 88.88885
SC.TER.UNITS# <i>n</i>	Tertiary units	LB, <b>KG</b> (default), OZ, TN, T, G, CUSTOM1, CUSTOM2, CUSTOM3, NONE
SC.TER.ENABLED# <i>n</i>	Enable the Tertiary Units	<b>OFF</b> (default), ON
SC.CUNITS1# <i>n</i> SC.CUNITS2# <i>n</i> SC.CUNITS3# <i>n</i>	Sets label for available custom units; maximum length is 2 alphanumeric characters	<b>"blank"</b> (default)
SC.CUNITSMULT1# <i>n</i> SC.CUNITSMULT2# <i>n</i> SC.CUNITSMULT3# <i>n</i>	Sets conversion factor/multiplier applied to the primary units to convert weight for custom units	0.000001 to 9999999.0, <b>1.0</b> (default)
SC.FILTERCHAIN# <i>n</i>	Defines what filter to use	<b>AVGONLY</b> (default), ADPONLY, DMPONLY, RAW
SC.DAMPINGVALUE# <i>n</i>	Sets the damping time constant	1–2560 (in 0.1 second intervals), <b>10</b> (default)
SC.ADTHRESHOLD# <i>n</i>	Adaptive filter weight threshold value	0–2000 (in display divisions), <b>10</b> (default)
SC.ADSENSITIVITY# <i>n</i>	Adaptive filter sensitivity	<b>LIGHT</b> (default), MEDIUM, HEAVY
SC.ACCUM# <i>n</i>	Accumulator enable	<b>OFF</b> (default), ON
SC.WZERO# <i>n</i>	Perform zero calibration	—
SC.TEMPZERO# <i>n</i>	Perform temporary zero calibration	—
SC.LASTZERO# <i>n</i>	Perform last zero calibration	—
SC.WVAL# <i>n</i>	Test weight value	0.000001–9999999.999999, <b>10000.0</b> (default)
SC.WSPAN# <i>n</i>	Perform span calibration	—
SC.WLIN.F1# <i>n</i> – SC.WLIN.F4# <i>n</i>	Actual raw count value for linear points 1–4	0–16777215, <b>0</b> (default)
For commands ending with # <i>n</i> , <i>n</i> is the scale number (1)		

Table 12-5. Scale Parameter Setting Commands (Continued)

Command	Description	Values
SC.WLIN.V1#n– SC.WLIN.V4#n	Test weight value for linear points 1–4 (A setting of 0 indicates the linear point is not used)	0.000001–9999999.999999, <b>0.0</b> (default)
SC.WLIN.C1#n– SC.WLIN.C4#n	Perform linear calibration on points 1–4	—
SC.LC.CD#n	Deadload coefficient raw count value	0–16777215, <b>8386509</b> (default)
SC.LC.CW#n	Span coefficient raw count value	0–16777215, <b>2186044</b> (default)
SC.LC.CZ#n	Temporary zero raw count value	0–16777215, <b>2186044</b> (default)
SC.REZERO#n	Perform the Rezero calibration function	—
SC.INITIALZERO#n	Initial Zero range in % of full scale	0.0–100.0, <b>0.0</b> (default)
SC.RTZGRAD#n	Number of graduations from the zero base at which the accumulator re-arms itself	0.0–100.0, <b>0.4</b> (default)

For commands ending with #n, n is the scale number (1)

Table 12-5. Scale Parameter Setting Commands (Continued)

## 12.6 Serial Port Setting Commands

The following commands can be used to configure serial port parameters.

Command	Description	Values
EDP.TRIGGER#p	Port serial input trigger function	<b>CMD</b> (default), STRIND, STRLFT, REMOTE
EDP.BAUD#p	Port baud rate	1200, 2400, 4800, <b>9600</b> (default), 19200, 28800, 38400, 57600, 115200
EDP.BITS#p	Port data bits/parity	<b>8NONE</b> (default), 8EVEN, 8ODD, 7EVEN, 7ODD
EDP.TERMIN#p	Port line termination character	<b>CR/LF</b> (default), CR
EDP.STOPBITS#p	Port stop bits	<b>1</b> (default), 2
EDP.ECHO#p	Port echo	<b>ON</b> (default), OFF
EDP.RESPONSE#p	Port response	<b>ON</b> (default), OFF
EDP.EOLDLY#p	Port end-of-line delay	0–255 (0.1-second intervals), <b>0</b> (default)
EDP.ADDRESS#p	Port RS-485 address (ports 3-5 only)	0–255, <b>0</b> (default)
EDP.DUPLEX#p	Port duplex setting for RS-485 ports (ports 3-5 only)	<b>FULL</b> (default), HALF
EDP.TYPE#p	Serial option card port type (ports 4-5 only)	<b>RS232</b> (default), RS485

For commands ending with #p, p is the port number (1-5)

Table 12-6. Serial Port Commands

### 12.6.1 Serial Ports

- Ports 1 and 2 are the two RS-232 ports
- Port 3 is the RS-485/422 port
- Port 4 and 5 are the two RS-232 or RS-485/422 ports on the optional Dual Serial Option Card

## 12.7 Ethernet and USB Setting Commands

The following commands can be used to configure Ethernet and USB parameters.

Command	Description	Values
WIRED.MACID	Ethernet hardware MAC ID (read only)	xx:xx:xx:xx:xx:xx
WIRED.DHCP	Enable Ethernet DHCP	<b>ON</b> (default), OFF
WIRED.ENABLED	Enable wired Ethernet adapter	ON, <b>OFF</b> (default)
WIRED.IPADDR	Ethernet IP address	Valid IP xxx.xxx.xxx.xxx*, <b>0.0.0.0</b> (default)
WIRED.SUBNET	Ethernet subnet mask	Valid IP xxx.xxx.xxx.xxx*, <b>255.255.255.0</b> (default)
WIRED.GATEWAY	Ethernet gateway	Valid IP xxx.xxx.xxx.xxx*, <b>0.0.0.0</b> (default)
TCPC1.ECHO	TCP Client 1 echo	<b>ON</b> (default), OFF
TCPC1.EOLDLY	TCP Client 1 end-of-line delay	0–255 (in 0.1 sec intervals), <b>0</b> (default)
TCPC1.IPADDR	TCP Client 1 remote server IP	Valid IP xxx.xxx.xxx.xxx*, <b>0.0.0.0</b> (default)
TCPC1.LINETERM	TCP Client 1 line termination	<b>CR/LF</b> (default), CR
TCPC1.PORT	TCP Client 1 remote server port	1025–65535, <b>10001</b> (default)
TCPC1.RESPONSE	TCP Client 1 response	<b>ON</b> (default), OFF
TCPC1.TRIGGER	TCP Client 1 input trigger type	<b>CMD</b> (default), STRIND, STRLFT, REMOTE
TCPC1.DISCTIME	TCP Client 1 disconnect time (in seconds)	0–60 (0 = do not disconnect), <b>0</b> (default)
TCPS.PORT	TCP Server port number	1025–65535, <b>10001</b> (default)
TCPS.HOSTNAME	TCP Server host name	Up to 30 alphanumeric characters, <b>0</b> (default)
TCPS.TRIGGER	TCP Server input trigger type	<b>CMD</b> (default), STRIND, STRLFT, REMOTE
TCPS.ECHO	TCP Server echo	<b>ON</b> (default), OFF
TCPS.LINETERM	TCP Server line termination	<b>CR/LF</b> (default), CR
TCPS.RESPONSE	TCP Server response	<b>ON</b> (default), OFF
USB.TRIGGER	USB input trigger type	<b>CMD</b> (default), STRIND, STRLFT, REMOTE
USB.LINETERM	USB line terminator	<b>CR/LF</b> (default), CR
USB.ECHO	USB echo	<b>ON</b> (default), OFF
USB.RESPONSE	USB response	<b>ON</b> (default), OFF
USB.EOLDLY	USB end of line delay (in 0.1 second intervals)	0–255, <b>0</b> (default)

\* A valid IP consists of four numbers, in the range of 0 to 255, separated by a decimal point (127.0.0.1 and 192.165.0.230 are valid IP addresses)

Table 12-7. Ethernet TCP/IP and USB Commands

## 12.8 Wi-Fi and Bluetooth® Setting Commands

The following commands can be used to configure Wi-Fi and Bluetooth® parameters.

Command	Description	Values
WIFIBT.ENABLED	Enables the wireless module and sets Wi-Fi and/or Bluetooth®	<b>OFF</b> (default), WIFI, BLUETOOTH, BOTH
WIFIBT.TRIGGER	Wi-Fi/Bluetooth® input trigger type	<b>CMD</b> (default), STRIND, STRLFT, REMOTE
WIFIBT.TERMIN	Wi-Fi/Bluetooth® line terminator	<b>CR/LF</b> (default), CR
WIFIBT.ECHO	Wi-Fi/Bluetooth® echo	<b>ON</b> (default), OFF
WIFIBT.RESPONSE	Wi-Fi/Bluetooth® response	<b>ON</b> (default), OFF
WIFIBT.EOLDLY	Wi-Fi/Bluetooth® end of line delay	0–255 (in 0.1 second intervals), <b>0</b> (default)
BLUETOOTH.MACID	Returns MAC address of the Bluetooth® radio (read only)	xx:xx:xx:xx:xx:xx
WIFI.MACID	Returns MAC address of the Wi-Fi radio (read only)	xx:xx:xx:xx:xx:xx

Table 12-8. Wi-Fi and Bluetooth® Commands

## 12.9 Fieldbus Setting Commands

The following commands can be used to configure Fieldbus parameters.

Command	Description	Values
FIELDBUS.NETWORK	Fieldbus network protocol	ETHERNET_IP (default), MODBUS, PROFIBUS, PROFINET, CANOPEN, DEVICENET, ETHERCAT
FIELDBUS.SWAP	Byte or Word swap, Both enables Byte and Word	NONE (default), BYTE, WORD, BOTH
FIELDBUS.AUTOIP	Automatically get network parameters from the network (DHCP)	OFF (default), ON
FIELDBUS.CANOPEN.NETWORKRATE	CANopen network node rate	1MB (default), 10 KB, 20KB, 50KB, 100KB, 125KB, 250KB, 500KB, 800KB
FIELDBUS.CANOPEN.NODE	CANopen node address	1-128, 1 (default)
FIELDBUS.DEVICENET.NETWORKRATE	DeviceNet network node rate	500KB (default), 125KB, 250KB
FIELDBUS.DEVICENET.NODE	DeviceNet node address	1-64, 1 (default)
FIELDBUS.ETHERNET_IP.GATEWAY	EtherNet/IP gateway; disabled if Auto IP is ON	0.0.0.0 (default)
FIELDBUS.ETHERNET_IP.IPADDR	EtherNet/IP IP address; disabled if Auto IP is ON	0.0.0.0 (default)
FIELDBUS.ETHERNET_IP.SUBNET	EtherNet/IP subnet; disabled if Auto IP is ON	255.255.255.0 (default)
FIELDBUS.MODBUS.GATEWAY	Modbus TCP gateway; disabled if Auto IP is ON	0.0.0.0 (default)
FIELDBUS.MODBUS.IPADDR	Modbus TCP IP address; disabled if Auto IP is ON	0.0.0.0 (default)
FIELDBUS.MODBUS.SUBNET	Modbus TCP subnet; disabled if Auto IP is ON	255.255.255.0 (default)
FIELDBUS.PROFIBUS.NODE	PROFIBUS node address	1-126, 1 (default)
FIELDBUS.PROFINET.GATEWAY	PROFINET gateway; disabled if Auto IP is ON	0.0.0.0 (default)
FIELDBUS.PROFINET.IPADDR	PROFINET IP address; disabled if Auto IP is ON	0.0.0.0 (default)
FIELDBUS.PROFINET.SUBNET	PROFINET subnet; disabled if Auto IP is ON	255.255.255.0 (default)

Table 12-9. Fieldbus Commands

## 12.10 Alibi Setting Commands

The following command can be used to configure Alibi parameters.

Command	Description	Values
ALIBI.ENABLED	Enables the storage of print transactions in the Alibi database	OFF (default), ON
ALIBI.COUNT	Returns number of records present	–
ALIBI.PRINT	Prints the alibi record at the specified record number; returns ?? <i>Invalid Index</i> if record doesn't exist and <i>OK</i> if successful For Example: ALIBI.PRINT=5 or ALIBI.PRINT=287	–
ALIBI.PURGE	Deletes the oldest 4 KB of records; returns how many records were deleted	–

Table 12-10. Alibi Commands

## 12.11 Truck Mode Setting Commands

The following commands can be used to configure truck mode parameters.

Command	Description	Values
TRUCK.MODE	Six available preset truck modes, see <a href="#">Section 7.0 on page 71</a>	OFF (default), MODE1, MODE2, MODE3, MODE4, MODE5, MODE6
TRUCK.IDOVRWRT	Allows duplicate Truck IDs to overwrite stored Truck IDs	DISABLE (default), ENABLE

Table 12-11. Truck Mode Commands



## 12.12 Stream Setting Commands

The following commands can be used to configure stream format parameters.

Command	Description	Values
STRM.FORMAT#n	Stream format	<b>RLWS</b> (default), <b>CARDNAL</b> , <b>WTRONIX</b> , <b>TOLEDO</b> , <b>CUSTOM</b>
STRM.CUSTOM#n	Custom stream definition	Up to 1,000 alphanumeric characters
STRM.GROSS#n	Mode token when streaming the Gross weight	Up to 8 alphanumeric characters, <b>G</b> (default)
STRM.NET#n	Mode token when streaming the Net weight	Up to 8 alphanumeric characters, <b>N</b> (default)
STRM.PRI#n	Units token when streaming Primary units	Up to 8 alphanumeric characters, <b>L</b> (default)
STRM.SEC#n	Units token when streaming Secondary units	Up to 8 alphanumeric characters, <b>K</b> (default)
STRM.TER#n	Units token when streaming Tertiary units	Up to 8 alphanumeric characters, <b>K</b> (default)
STRM.INVALID#n	Status token when streaming an Invalid weight	Up to 2 alphanumeric characters, <b>I</b> (default)
STRM.MOTION#n	Status token when the weight is in motion	Up to 2 alphanumeric characters, <b>M</b> (default)
STRM.POS#n	Polarity token when the weight is positive	<b>SPACE</b> (default), <b>NONE</b> , <b>+</b>
STRM.NEG#n	Polarity token when the weight is negative	<b>SPACE</b> , <b>NONE</b> , <b>-</b> (default)
STRM.OK#n	Status token when the weight is OK (not invalid, out of range, at zero or in-motion)	Up to 2 alphanumeric characters (default is a space)
STRM.TARE#n	Mode token when streaming the tare weight	Up to 8 alphanumeric characters, <b>T</b> (default)
STRM.RANGE#n	Status token when the weight is Out of Range	Up to 2 alphanumeric characters, <b>O</b> (default)
STRM.ZERO#n	Status token when the weight is at Center of Zero	Up to 2 alphanumeric characters, <b>Z</b> (default)
STRM.UNITS#n	Static uses EDP set Primary/Secondary units token; Dynamic defaults to configured units of the scale	<b>STATIC</b> (default), <b>DYNAMIC</b>

For commands ending with #n, n is the stream format number (1)

Table 12-12. Stream Formatting Commands

## 12.13 Program Commands

The following commands can be used to configure program parameters.

Command	Description	Values
PWD.USER	Sets user menu password; cannot query the current password	Up to 16 alphanumeric characters
PWD.SETUP	Sets setup menu password, cannot query the current password	Up to 16 alphanumeric characters
DATEFMT	Date format	<b>MMDDYY</b> (default), <b>DDMMYY</b> , <b>YYMMDD</b> , <b>YYDDMM</b>
DATESEP	Date separator	<b>SLASH</b> (default), <b>DASH</b> , <b>SEMI</b> , <b>DOT</b>
TIMEFMT	Time format	<b>12HOUR</b> (default), <b>24HOUR</b>
TIMESEP	Time separator	<b>COLON</b> (default), <b>COMMA</b> , <b>DOT</b>
CONSNUM	Consecutive numbering	0-9999999, <b>0</b> (default)
CONSTUP	Consecutive number start-up value	0-9999999, <b>0</b> (default)
UID	ID of the indicator	Up to 8 alphanumeric characters, <b>1</b> (default)
KYBDLK	Keyboard lock, disables keyboard except for the menu and power key	<b>OFF</b> (default), <b>ON</b>
ZERONLY	Disables keyboard except for the zero, menu and power keys	<b>OFF</b> (default), <b>ON</b>
CONTACT.COMPANY	Contact company name	Up to 30 alphanumeric characters
CONTACT.ADDR1-3	Contact company address	Up to 20 alphanumeric characters (for each line)
CONTACT.NAME1-3	Contact names	Up to 30 alphanumeric characters (for each line)
CONTACT.PHONE1-3	Contact phone numbers	Up to 20 alphanumeric characters (for each line)
CONTACT.EMAIL	Contact email address	Up to 40 alphanumeric characters
CONTACT.LASTCAL	Last calibration date	Date MMDDYYYY as an 8-digit number
CONTACT.NEXTCAL	Next calibration date	Date MMDDYYYY as an 8-digit number
KHOLDTIME	Key hold time (in tenths of a second); 20 equals 2 seconds	10-50, <b>20</b> (default)
KHOLDINTERVAL	Key hold time interval; the amount of time between increments during a key hold (in twentieths of a second); 2 equals a tenth of a second (10 increments per second during a key hold)	1-100, <b>2</b> (default)
LOCALE	Enable gravity compensation	<b>OFF</b> (default), <b>ON</b> , <b>FACTOR</b>
LAT.LOC	Origin latitude (to nearest degree) for gravity compensation	0-90, <b>45</b> (default)

Table 12-13. Feature Commands

Command	Description	Values
ELEV.LOC	Origin elevation (in meters) for gravity compensation	-9999–9999, <b>345</b> (default)
DEST.LAT.LOC	Destination latitude (in degrees) for gravity compensation	0–90, <b>45</b> (default)
DEST.ELEV.LOC	Destination elevation (in meters) for gravity compensation	-9999–9999, <b>345</b> (default)
GRAV.LOC	Origin gravity factor (in m/s <sup>2</sup> ) for gravity compensation	9.00000–9.99999, <b>9.80665</b> (default)
DEST.GRAV.LOC	Destination gravity factor (in m/s <sup>2</sup> ) for gravity compensation	9.00000–9.99999, <b>9.80665</b> (default)
PERSISTENTTARE	Determines if a tare remains through a power cycle	<b>OFF</b> (default), ON
REMOTE.PRINTDESTINATION	Determines whether the remote (another indicator) or local (682) indicator prints when the print key is pressed on the remote	<b>REMOTE</b> (default), LOCAL
LANGUAGE	Sets the text language; applies to <i>Weigh</i> mode only	<b>ENGLISH</b> (default), SPANISH, FRENCH, GERMAN, DUTCH, PORTUGUESE, ITALIAN

Table 12-13. Feature Commands (Continued)

## 12.14 Regulatory Commands

The following commands can be used to configure regulatory parameters.

Command	Description	Values
REGULAT	Regulatory mode	<b>NTEP</b> (default), CANADA, INDUST, NONE, OIML, AUSTRALIA
AUDAGNCY	Audit Agency (Industrial Mode)	<b>NTEP</b> (default), CANADA, NONE, OIML
REG.SNPSHOT	Display or Scale weight source	<b>DISPLAY</b> (default), SCALE
REG.ZTARE	Remove tare on ZERO	<b>NO</b> (default), YES
REG.KTARE	Always allow keyed tare	NO, <b>YES</b> (default)
REG.MTARE	Multiple tare action	<b>REPLACE</b> (default), REMOVE, NOTHING
REG.NTARE	Allow negative tare	<b>NO</b> (default), YES
REG.CTARE	Allow Clear key to clear tare/accumulator	NO, <b>YES</b> (default)
REG.NEGTOTAL	Allow total scale to display negative value	<b>NO</b> (default), YES
REG.PRTMOT	Allow print while in motion	<b>NO</b> (default), YES
REG.PRINTPT	Add PT to keyed tare print	NO, <b>YES</b> (default)
REG.OVRBASE	Zero base for overload calculation	<b>CALIB</b> (default), SCALE
REG.AZTNET	Perform AZT on Net value	<b>NO</b> (default), YES
REG.MANUALCLEARARE	Allows manual clearing of the tare value	NO, <b>YES</b> (default)
REG.TAREINMOTION	Allows Tare in Motion	<b>NO</b> (default), YES
REG.ZEROINMOTION	Allows scale to be zeroed while in motion	<b>NO</b> (default), YES
REG.UNDERLOAD	Underload weight value in display divisions	1–9999999, <b>20</b> (default)
REG.DISPLAYCAPACITY	Displays configured capacity	NO, <b>YES</b> (default)*
REG.DISPLAYCOUNTBY	Displays configured count-by	NO, <b>YES</b> (default)*
REG.RTARE	Round the Pushbutton Tare	NO, <b>YES</b> (default)
REG.RKTARE	Round the Keyed Tare	NO, <b>YES</b> (default)

NTEP defaults shown for regulatory command values  
 \*If REGULAT is set to AUSTRALIA, default is set to NO. If set to INDUST, default is set as desired.

Table 12-14. Regulatory Commands

## 12.15 Setpoint Commands

The following commands can be used to configure setpoint parameters.

Command	Description	Values
BATCHNG	Batching mode	<b>OFF</b> (default), AUTO, MANUAL
SP.KIND#n	Setpoint kind	<b>OFF</b> (default), GROSS, NET, -GROSS, -NET, ACCUM, POSREL, NEGREL, PCTREL, PAUSE, DELAY, WAITSS, COUNTER, AUTOJOG, COZ, INMOTON, INRANGE, BATCHPR, TIMER, CONCUR, TOD, ALWAYS, NEVER
SP.VALUE#n	Setpoint value	0.0–9999999.0, <b>0.0</b> (default)
SP.TRIP#n	Trip	<b>HIGHER</b> (default), LOWER, INBAND, OUTBAND

Table 12-15. Setpoints Commands



Command	Description	Values
SP.BANDVAL# <i>n</i>	Band value	0.0–9999999.0, <b>0.0</b> (default)
SP.HYSTER# <i>n</i>	Hysteresis	0.0–9999999.0, <b>0.0</b> (default)
SP.PREACT# <i>n</i>	Preact type	<b>OFF</b> (default), ON, LEARN
SP.PREVAL# <i>n</i>	Preact value	0.0–9999999.0, <b>0.0</b> (default)
SP.PREADJ# <i>n</i>	Preact adjustment percentage	0.0–100.0, <b>50.0</b> (default)
SP.PRESTAB# <i>n</i>	Preact learn stability (in tenths of a second)	0–65535, <b>0</b> (default)
SP.PCOUNT# <i>n</i>	Preact learn interval	1–65535, <b>1</b> (default)
SP.BATCH# <i>n</i>	Batch step enable	<b>OFF</b> (default), ON
SP.CLRACCM# <i>n</i>	Clear accumulator enable	<b>OFF</b> (default), ON
SP.CLRTARE# <i>n</i>	Clear tare enable	<b>OFF</b> (default), ON
SP.PSHACCM# <i>n</i>	Push accumulate	<b>OFF</b> (default), ON, ONQUIET
SP.PSHPRINT# <i>n</i>	Push print	<b>OFF</b> (default), ON, WAITSS
SP.PSHTARE# <i>n</i>	Push tare	<b>OFF</b> (default), ON
SP.ALARM# <i>n</i>	Alarm enable	<b>OFF</b> (default), ON
SP.ALIAS# <i>n</i>	Setpoint name	Up to 8 alphanumeric characters, <b>SETPT</b> (default)
SP.ACCESS# <i>n</i>	Setpoint access	OFF, <b>ON</b> (default), HIDE
SP.DSLOT# <i>n</i>	Digital output slot (0 for on-board DIO, 1 for the optional relay card)	<b>NONE</b> (default), 0, 1
SP.DIGOUT# <i>n</i>	Digital output	1–4, <b>1</b> (default)
SP.SENSE# <i>n</i>	Digital output sense	<b>NORMAL</b> (default), INVERT
SP.BRANCH# <i>n</i>	Branch destination (0 = do not branch)	0–8, <b>0</b> (default)
SP.RELNUM# <i>n</i>	Relative setpoint number	1–8, <b>1</b> (default)
SP.START# <i>n</i>	Starting setpoint	1–8, <b>1</b> (default)
SP.END# <i>n</i>	Ending setpoint	1–8, <b>1</b> (default)
SP.TIME# <i>n</i>	Trip time	hhmm, <b>0000</b> (default)
SP.DURATION# <i>n</i>	Trip duration	hhmmss, <b>000000</b> (default)
SP.ENABLE# <i>n</i>	Setpoint enable	OFF, <b>ON</b> (default)

For setpoint commands ending with #*n*, *n* is the setpoint number (1-8)

Table 12-15. Setpoints Commands (Continued)

## 12.16 Batching Control Commands

The commands listed in [Table 12-16](#) provide batching control through a communications port.

Command	Description	Values
BATSTART	Batch Start	If the BATRUN digital input is active or not assigned, the BATSTART command can be used to start the batch program
BATSTOP	Batch Stop	Stops an active batch and turns off all associated digital outputs; Requires a Batch Start to resume processing
BATPAUSE	Batch Pause	Pauses an active batch and turns off all digital outputs except those associated with Concurrent and Timer setpoints; processing is suspended until the indicator receives a Batch Start signal; pressing the Batch Start digital input, BATSTART serial command, Batch Start softkey or the StartBatch function (in iRite) resumes the batch and re-energizes all digital outputs turned off by the Batch Pause
BATRESET	Batch Reset	Stops the program and resets the batch program to the first batch step; use the BATRESET command after making changes to the batch configuration
BATSTATUS	Batch Status	Returns XYYY where X is S (if the batch is stopped), P (if the batch is paused), R (if the batch is running); and YYY is the setpoint number the batch is currently on (1-8)

Table 12-16. Batching Control Commands

## 12.17 Print Format Commands

The following commands can be used to configure print format parameters.

Command	Description	Values
GFMT GFMT.PORT GFMT.PORT2	Gross demand print format string	<p>Each format can be sent out one or two ports; for the .PORT and .PORT2 commands, specify the port name as one of the following: RS232-1 (PORT default), RS232-2, RS485, TCPC, TCPS, USB, SRLCRD1, SRLCRD2, WIFIBT, NONE (PORT2 default)</p> <p><i>Example: To send the Gross format out both the RS-232 Port 2 and the Wi-Fi and Bluetooth® Port at the same time, send:</i></p> <p style="padding-left: 40px;"><i>GFMT.PORT=RS232-2</i></p> <p style="padding-left: 40px;"><i>GFMT.PORT2=WIFIBT</i></p> <p>See <a href="#">Section 13.0 on page 109</a> for information about demand print format strings</p>
NFMT NFMT.PORT NFMT.PORT2	Net demand print format string	
ACCFMT ACC.PORT ACC.PORT2	Accumulator print format string	
SPFMT SPFMT.PORT SPFMT.PORT2	Setpoint print format string	
HDRFMT1 HDRFMT2	Ticket header format strings	
AUXFMT#1-4 AUX.PORT#1-4 AUX.PORT2#1-4	Auxiliary print format strings	
TRFMT TRFMT.PORT TRFMT.PORT2	Truck print format string	
TRWINFMT TRWINFMT.PORT TRWINFMT.PORT2	Truck weigh-in print format string	
TRWOUTFMT TRWOUTFMT.PORT TRWOUTFMT.PORT2	Truck weigh-out print format string	
AUD.DEST1 AUD.DEST2	Audit destination print ports	
CAVGFMT CAVGFMT.PORT CAVGFMT.PORT2	Count average format string	

Table 12-17. Print Format Commands

## 12.18 Digital I/O Commands

The following commands can be used to configure digital I/O parameters.

Command	Description	Values
DIO. <i>b#s</i>	Sets DIO type	<b>OFF</b> (default), OUTPUT, PRIM, PRINT, SEC, TARE, UNITS, ZERO, BATRUN, BATSTART, BATPAUSE, BATRESET, BATSTOP, CLEAR, CLRACC, CLRCN, CLRTAR, DSPACC, DSPTAR, GROSS, KBDLOC, NET, NT/GRS
DOFF. <i>b#s</i>	Sets digital output to OFF	–
DON. <i>b#s</i>	Set digital output to ON	–
DIN. <i>b#s</i>	Returns a bit-weighted integer number based on the state of the DIO pins; the command looks at the raw state of the pins (input or output); if all are inactive, it returns 0; if all are active, it returns 15	–
Valid bit values ( <i>b</i> ) are 1-4; For commands ending with <i>#s</i> , <i>s</i> is the slot assigned to the digital I/O (0); Slot 0 is onboard		

Table 12-18. Digital I/O Commands

## 12.19 Analog Output Commands

The following commands can be used to configure analog output parameters.

Command	Description	Values
ALG.SOURCE#s	Analog output source	<b>SCALE1</b> (default), REMOTE
ALG.MODE#s	Mode	<b>GROSS</b> (default), NET
ALG.OUTPUT#s	Type of output	<b>0-10V</b> (default), 0-20MA, 4-20MA
ALG.ERRACT#s	Error action	<b>FULLSC</b> (default), HOLD, ZEROSC
ALG.MIN#s	Minimum value tracked	±9999999.0, <b>0.0</b> (default)
ALG.MAX#s	Maximum value tracked	±9999999.0, <b>10000.0</b> (default)
ALG.TWZERO#s	Adjusts the offset of the analog output zero value	0-65535, <b>0</b> (default)
ALG.TWSPAN#s	Adjusts the offset of the analog output span value	0-65535, <b>59515</b> (default)

For commands ending with #s, s is the slot number assigned to the analog output (1)

Table 12-19. Analog Output Commands

## 12.20 Softkey Setting Commands

The following command can be used to configure the function of the five softkeys.

Command	Description	Values
SOFTKEY.FUNCTION#s	Function assigned to each available softkey	<b>NONE</b> (default), BLANK, TIMEDATE, DSPTAR, DSPACC, SETPOINT, BATSTOP, BATSTRT, BATPAUS, BATRESET, DSPUID, ALIBI, TRUCKWEIGHIN, TRUCKWEIGHOUT, ENTERTRUCKREGS, PRINTAUXFMT1, PRINTAUXFMT2, PRINTAUXFMT3, PRINTAUXFMT4, STOP, GO, USERSTRING1, COUNTAVERAGE, OFF
COUNT	Displays most recent count entered with the Count Average softkey	–

For commands ending with #s, s is the softkey number (1-15)

Table 12-20. Softkey Commands



**NOTE:** See [Section 4.5.11 on page 64](#) for softkey menu location and softkey descriptions.

## 12.21 User String Commands

The following command can be used to configure the function of user strings.

Command	Description	Values
USERSTRING1.DISPLAYMESSAGE	Inserts a display message on the main screen. The {} will be replaced with the user string entered by the user	0-60 alphanumeric characters
USERSTRING1.KEYBOARDTYPE	Displays the on-screen keyboard	<b>ALPHANUMERIC</b> (default), NUMERIC
USERSTRING1.MESSAGESURATION	If temporary, message displays until new message inserted; If permanent, new message displays then returns to the original user message	<b>PERMANENT</b> (default), TEMPORARY
USERSTRING1.PROMPTTEXT	Inserts text at the top of the User entry prompt	0-32 alphanumeric characters
USERSTRING1.SOFTKEYTEXT	Inserts text on the User String softkey	0-16 alphanumeric characters
USERSTRING1	Returns current value	–
	Updates value used in the <US1> token and display	0-128 alphanumeric characters

Table 12-21. Softkey Commands

## 12.22 Weigh Mode Commands

These commands function in *Weigh* mode. Non-weight-related commands work in *Setup* mode.

Command	Description	Values
P	Returns what the indicator is currently displaying	--
P#n	Prints auxiliary format #n	n = 1-4
ZZ	Returns currently displayed annunciators	See <a href="#">Section 16.4 on page 126</a>
CONSNUM	Returns current consecutive number value	0–9999999, 0 (default)
UID	Sets or returns the unit ID	Up to 8 alphanumeric characters, 1 (default)
SD	Sets or returns the current system date	MMDDYY, DDMMYY, YYMMDD, or YYDDMM. Enter six-digit date using the year-month-day order specified for the DATEFMT parameter, using only the last two digits of the year; The current system date is returned by only sending SD
ST	Sets or returns the current system time	HHMM (enter using 24-hour format) The current system time is returned by only sending ST
STS	Sets or returns the current system time with seconds	HHMMSS (enter using 24-hour format) The current system time is returned by only sending STS
RS	Resets system	Soft reset; Used to reset the indicator without resetting the configuration to the factory defaults
SX	Starts all serial data streams	--
EX	Stops all serial data streams	--
SX#p	Starts serial data stream for port p	OK or ??
EX#p	Stops serial data stream for port p	An EX command sent while in <i>Setup</i> mode does not take effect until the indicator is returned to <i>Weigh</i> mode
S	Returns a single stream frame from the displayed scale using the currently configured stream format	--
SF#n	Returns a single stream frame from scale n using the standard Rice Lake format.	--
XA#n	Returns the accumulator value in displayed units	nnnnnnnn UU
XAP#n	Returns the accumulator value in primary units	
XAS#n	Returns the accumulator value in secondary units	
XAT#n	Returns the accumulator value in tertiary units	
XG#n	Returns the gross weight in displayed units	nnnnnnnn UU
XGP#n	Returns the gross weight in primary units	
XGS#n	Returns the gross weight in secondary units	
XGT#n	Returns the gross weight in tertiary units	
XN#n	Returns the net weight in displayed units	nnnnnnnn UU
XNP#n	Returns the net weight in primary units	
XNS#n	Returns the net weight in secondary units	
XNT#n	Returns the net weight in tertiary units	
XT#n	Returns the tare weight in displayed units	nnnnnnnn UU
XTP#n	Returns the tare weight in primary units	
XTS#n	Returns the tare weight in secondary units	
XTT#n	Returns the tare weight in tertiary units	

For commands ending with #n, n is the scale number (1); For commands ending with #p, p is the port number (1-6), see [Section 12.6.1 on page 100](#)

Table 12-22. Weigh Mode Commands

## 13.0 Print Formatting

---

The 682 provides multiple print formats, Gross, Net, Accumulator, Setpoint, Header, Auxiliary 1-4, Truck, Truck Weigh-In, and Truck Weigh-Out, which determine the format of the printed output when the **Print** key is pressed. If a tare has been entered or acquired, Net is used; otherwise, Gross is used.

Each print format can be customized to include up to 1,000 characters of information, such as company name and address, on printed tickets. Use the print format menu through the indicator front panel, or EDP commands, to customize the print formats.

List of print formats and the associated EDP commands:

- Gross Format (GFMT)
- Net Format (NFMT)
- Accumulator Format (ACCFMT)
- Setpoint Format (SPFMT)
- Header Format (HDRFMT1-2)
- Auxiliary Format 1-4 (AUXFMT#1-4)
- Truck Format (TRFMT)
- Truck Weigh-In Format (TRWINFMT)
- Truck Weigh-Out Format (TRWOUTFMT)
- Audit Trail Port (AUD.DEST1-2)
- Count Average Format (CAVGFMT)

## 13.1 Print Formatting Tokens

Table 13-1 lists tokens which can be used to configure the print formats. Tokens included in the format strings must be enclosed between < and > delimiters. Characters outside of the delimiters are printed as text on the ticket. Text characters can include ASCII characters, which can be printed by the output device.

Token	Description	Supported Ticket Formats
<i>General Weight Data Tokens</i>		
<Gx>	Gross weight, current scale	GFMT, NFMT, ACCFMT, SPFMT, AUXFMT, TRFMT, TRWINFMT, TRWOUTFMT, CAVGFMT
<Gx#n>	Gross weight, scale <i>n</i>	
<Nx>	Net weight, current scale	
<Nx#n>	Net weight, scale <i>n</i>	
<Tx>	Tare weight, current scale	
<Tx#n>	Tare weight, scale <i>n</i>	
<S>	Current scale number	
<CAW>	Count average weight	
<CNT>	Count value	
<SHK>	Current shrink value	
<SW>	Weight value with shrink	
<SWG>	Gross weight with shrink	
<SWN>	Net weight with shrink	
<SWC>	Average count weight with shrink	
<p><b>NOTE:</b> For tokens with #<i>n</i>, <i>n</i> is the scale number (1). For tokens with an <i>x</i>, <i>x</i> is the character width of the weight field with padded spaces on the left. If <i>x</i> is not specified, 10 is the assumed default for the weight field. <i>x</i> can be set using one or two digits and sets the minimum number of characters in the weight field, but expands to show all characters for a value that has more characters than the minimum value set with <i>x</i>.  Example: To format a ticket to provide gross weight for Scale 1 with a minimum of 6 print characters, use the following token: &lt;G6#1&gt;</p> <p><b>NOTE:</b> Gross, net and tare weights can be printed in any configured weight unit by adding modifiers to the gross, net, and tare weight tokens: /P (primary units), /D (displayed units), /S (secondary units) or /T (tertiary units). If not specified, the currently displayed unit (/D) is assumed.  Example: To format a ticket to provide net weight in secondary units, use the following token: &lt;N/S&gt;</p> <p><b>NOTE:</b> Formatted weight strings default to contain a 10-digit weight field (including sign and decimal point), followed by a space and a 2-digit unit identifier. Total field length with unit identifier is 13 characters. For tokens with an <i>x</i>, total field length with unit identifier is <i>x</i> + 3.</p>		
<i>Accumulator Tokens</i>		
<A>	Accumulated weight, current scale; Prints to 15 digits	GFMT, NFMT, ACCFMT, AUXFMT
<A#n>	Accumulated weight, scale <i>n</i>	
<AA>	Average accumulation, current scale	
<AA#n>	Average accumulation, scale <i>n</i>	
<AC>	Number of accumulations, current scale	
<AC#n>	Number of accumulations, scale <i>n</i>	
<ACNT>	Accumulated count	
<ACAW>	Accumulated count average weight	
<SWA>	Accumulated weight with shrink	
<SWAC>	Average accumulated weight with shrink	
<AT>	Time of last accumulation, current scale	
<AT#n>	Time of last accumulation, scale <i>n</i>	
<AD>	Date of last accumulation, current scale	
<AD#n>	Date of last accumulation, scale <i>n</i>	

Table 13-1. Print Format Tokens

Token	Description	Supported Ticket Formats	
<b>NOTE: For tokens with #n, n is the scale number (1).</b>			
<b>Setpoint Tokens</b>			
<SCV>	Setpoint captured value	SPFMT	
<SN>	Setpoint number		
<SNA>	Setpoint name		
<SPM>	Setpoint mode (gross or net label)		
<SPV>	Setpoint preact value		
<STV>	Setpoint target value		
<b>Auditing Tokens</b>			
<CD>	Last calibration date	All	
<NOC>	Number of calibrations		
<NOW>	Number of weighments since last calibration		
<b>NOTE: Last calibration date (&lt;CD&gt;) and number of calibrations (&lt;NOC&gt;) are updated anytime a calibration is performed on any of the scales. Number of weighments (&lt;NOW&gt;) is incremented whenever the scale weight exceeds 10% of scale capacity. Scale must return to gross or net zero before the value can be incremented again.</b>			
<b>Formatting and General-Purpose Tokens</b>			
<nnn>	ASCII character ( <i>nnn</i> = decimal value of ASCII character); used for inserting control characters (STX, for example) in the print stream	All	
<TI>	Time		
<DA>	Date		
<TD>	Time and date		
<UID>	Unit ID number (up to 8 alphanumeric characters)		
<CN>	Consecutive number (up to 7 digits)		
<H1>	Insert header format 1 (HDRFMT1), see <a href="#">Table 13-2 on page 112</a>		
<H2>	Insert header format 2 (HDRFMT2), see <a href="#">Table 13-2 on page 112</a>		
<CR>	Carriage return character		
<LF>	Line feed character		
<NL <i>nn</i> >	New line ( <i>nn</i> = number of termination (<CR/LF> or <CR>) characters)*		
<SP <i>nn</i> >	Space ( <i>nn</i> = number of spaces)*		
<SU>	Toggle weight data format (formatted/unformatted)		
<b>NOTE: If <i>nn</i> is not specified, 1 is assumed. Value must be in the range 1–99.</b>			
<b>Header Format Tokens</b>			
<COMP>	Company name (up to 30 characters)	All	
<COAR1> <COAR2> <COAR3>	Company address, lines 1–3 (up to 30 characters)		
<CONM1> <CONM2> <CONM3>	Company contact names (up to 20 characters)		
<COPH1> <COPH2> <COPH3>	Company contact phone numbers (up to 20 characters)		
<COML>	Company contact e-mail address (up to 30 characters)		
<b>Truck Format Tokens</b>			
<TID>	Truck ID (up to 16 characters)		TRFMT, TRWINFMT, TRWOUTFMT
<TR1>	Gross weight for current ticket in displayed units		
<TR2>	Tare weight (inbound) for current ticket in displayed units		
<TR3>	Net weight (outbound) for current ticket in displayed units		

Table 13-1. Print Format Tokens (Continued)

Token	Description	Supported Ticket Formats
<p><b>NOTE: TR1, TR2 and TR3 truck ticket weight data includes keywords INBOUND, KEYED and RECALLED, as needed.</b>  <b>NOTE: TR1, TR2 and TR3 allow for printing secondary and tertiary units. (&lt;TR1/S&gt;&lt;TR1/T&gt;&lt;TR2/S&gt;&lt;TR2/T&gt;&lt;TR3/S&gt;&lt;TR3/T&gt;)</b></p>		

Table 13-1. Print Format Tokens (Continued)

Format	Default Format String	When Used
GFMT	GROSS<G><NL2><TD><NL>	Weigh mode – no tare in system
NFMT	GROSS<G><NL>TARE<SP><T><NL>NET<SP2><N><NL2><TD><NL>	Weigh mode – tare in system
ACCFMT	ACCUM <A><NL><DA> <TI><NL>	Accumulator demand print format string
SPFMT	<SCV><SP><SPM><NL>	Setpoint print operation with Push Print = ON
HDRFMT <sub>n</sub>	COMPANY NAME<NL>STREET ADDRESS<NL>CITY ST ZIP<NL2>	Header format strings ( <i>n</i> =1-2)
AUXFMT#1	<G><T><N><CR><CN><CR>	Auxiliary print format string 1
AUXFMT# <i>n</i>	GROSS<G><NL2><TD><NL>	Auxiliary print format strings ( <i>n</i> =2-4)
TRFMT	REG ID: <TID>: <TR2> <TD><NL>	Weigh mode – truck in/out applications
TRWINFMT	<NL>ID<SP><TID><NL2>GROSS<SP><TR1><NL2><DA><SP><TI><NL>	Weigh mode – truck in/out applications
TRWOUTFMT	<NL6>ID<SP><TID><NL2>GROSS<TR1><NL>TARE<SP><TR2><NL>NET<SP2><TR3><NL2><DA><SP><TI><NL>	Weigh mode – truck in/out applications
CAVGFMT	GROSS<G><NL2><TD><NL2><Count: <CNT><NL>Average Count Weight: <CAW><NL>	Count entered on the COUNTAVERAGE print token

Table 13-2. Default Print Formats



**NOTE: The 1,000 character limit of each print format string includes the output field length of the print formatting tokens, not the token length. For example, if the indicator is configured to display a decimal point, the <G> token generates an output field of 13 characters: the 10 character weight value (including decimal point), one space, and a two-digit units identifier. For tokens with an *x* (e.g. <Gx> or <Gx#n>), total field length with unit identifier is  $x + 3$ .**

**PT (preset tare) is added to the tare weight if tare was keyed in.**



## 13.2 Customizing Print Formats

The Gross (GFMT), Net (NFMT), Accumulator (ACCFMT), Setpoint (SPFMT), Header (HDRFMT1-2), Auxiliary 1-4 (AUXFMT#1-4), Truck (TRFMT), Truck Weigh-In (TRWINFMT), Truck Weigh-Out (TRWOUTFMT) and Count Average (CAVGFMT) formats can be customized using the print format menu via the front panel. See [Section 4.5.6 on page 56](#) for the print format menu structure. To access the print format menu the indicator must be in *Setup* mode ([Section 4.1 on page 40](#)).

The print format menu via the front panel can be used to customize the print formats and to edit the print format strings with the full keyboard that appears on the display when entering a format string. See [Section 3.3.2 on page 31](#) for the alphanumeric entry procedure to edit the print format strings.

## 13.3 Non-Human Readable Characters

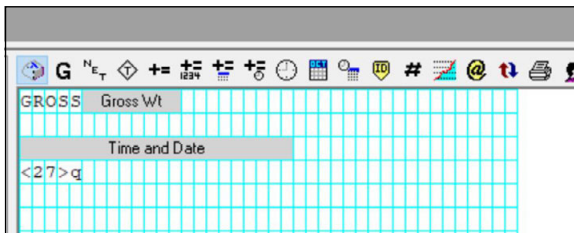
ASCII characters 0 through 31 are non-human readable characters. To include a special character in a print format, the decimal equivalent needs to be used. For example, the special character *Esc* would be <27> or 60, 50, 55, 62 (less the commas).

Examples of a print release command for a TMU295 in the GROSS format:

**Print Format:**

GROSS<G><NL2><TD><NL><27>q

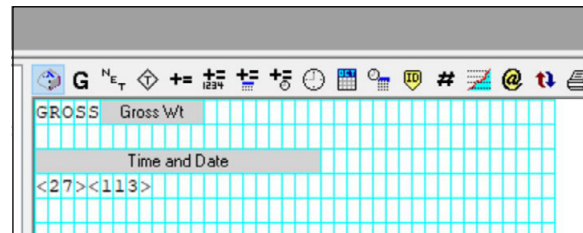
**In Revolution:**



**Print Format:**

GROSS<G><NL2><TD><NL><27><113>

**In Revolution:**



## 13.4 Configuring Auxiliary Print Formats for LaserLight Control

Auxiliary print formats 1-3 must be configured using Revolution to allow softkey control of LaserLight Stop/Go/Off light features.

LaserLight State	Auxiliary Format	Format String
Stop	1	00D03!
Go	2	00D02!
Off	3	00D00!

Table 13-3. Auxiliary Print Format Strings

Follow the procedure below to configure auxiliary print formats with Revolution:

1. Launch Revolution.
2. Select **Ticket Formatting**.
3. Select **Ticket Information**.
4. Select **Auxiliary Formats#1**.

- Under Printer Model, highlight **LaserLight**.

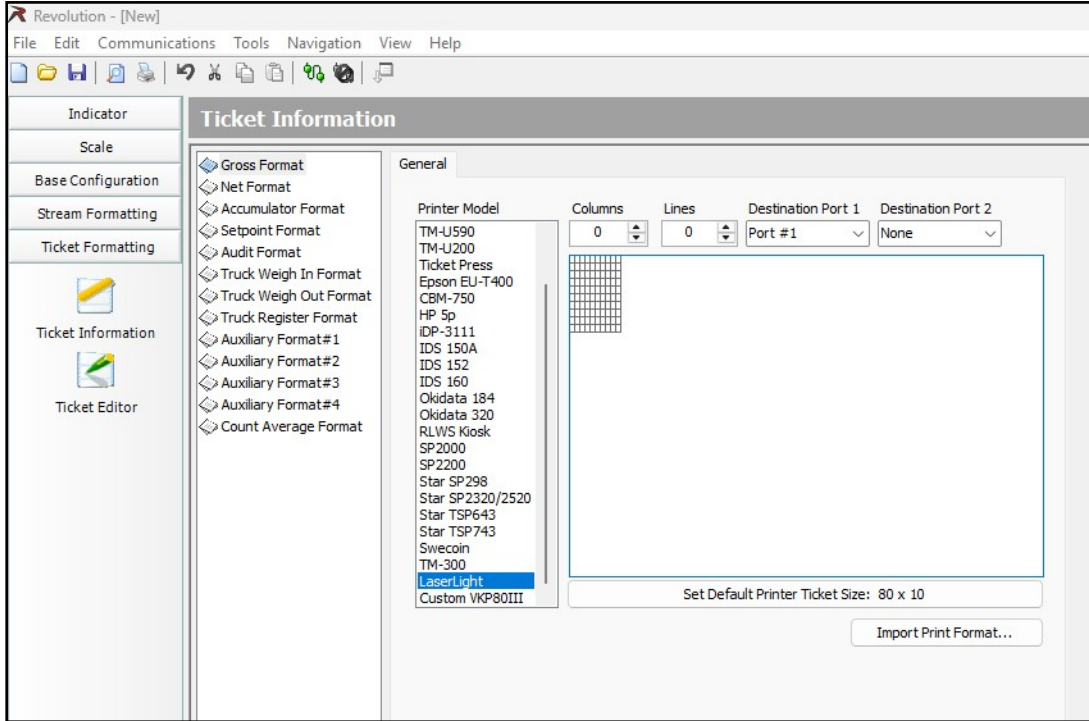


Figure 13-1. Ticket Information

- Repeat [Step 4](#) and [Step 5](#) for Auxiliary Formats#2 and Auxiliary Formats#3.
- Select **Ticket Editor**.
- Select **Auxiliary Format#1**.
- Clear the grid field if necessary.

10. Insert the format string for Auxiliary Format#1 (see [Table 13-3](#)).

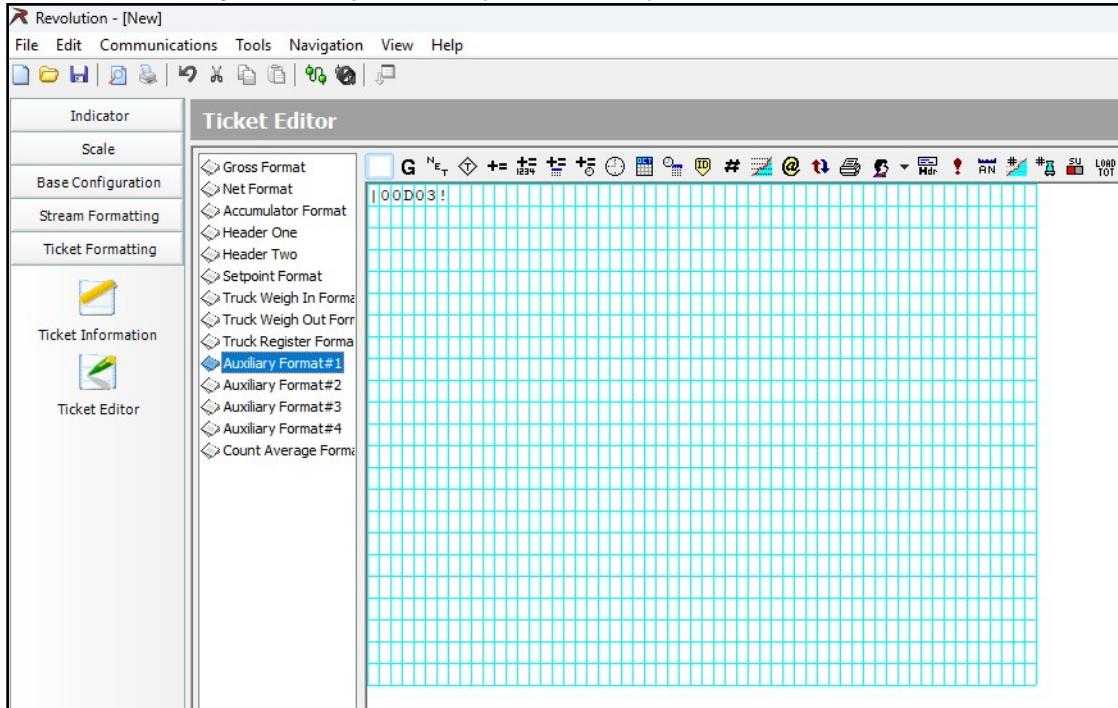


Figure 13-2. Ticket Editor

11. Repeat [Step 8](#) through [Step 10](#) for Auxiliary Format#2 and Auxiliary Format#3.
12. Download the edited print formats to the indicator (see [Section 11.2.2 on page 95](#)).
13. Stop/Go/Off Softkeys display.

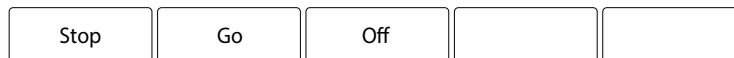


Figure 13-3. Stop Go and Off Softkeys

## 14.0 Setpoints

The 682 indicator provides eight configurable setpoints for control of both indicator and external equipment functions. Setpoints can be configured to perform actions or functions based on specified parameter conditions. Parameters associated with various setpoint kinds can, for example, be configured to perform functions (print, tare, accumulate), to change the state of a digital output controlling indicator or external equipment functions, or to make conditional decisions.



**NOTE:** *Weight-based setpoints are tripped by values specified in primary units only.*

### 14.1 Continuous and Batch Setpoints

682 setpoints can be either continuous or batch.

**Continuous setpoints** are free-running; the indicator constantly monitors the condition of free-running setpoints at each A/D update. The specified setpoint action or function is performed when the designated setpoint parameter conditions are met. A digital output or function assigned to a free-running setpoint continuously changes state, becoming active or inactive, as defined by the setpoint parameters.

**Batch setpoints (Batch = On)** which have digital outputs associated to them remain active until the setpoint condition is met. The setpoint is then latched for the remainder of the batch sequence.

To use batch setpoints, set the Batching parameter in the Setpoint menu. This parameter defines whether a batch sequence is automatic or manual. Auto sequences repeat continuously after receiving a single batch start signal, while Manual sequences only run through once for each batch start signal. The batch start signal can be initiated by a digital input (set to Batch Start), or an EDP command (BATSTART).

For a setpoint to be used as part of a batch sequence, its batch sequence (Batch) parameter must be set to On. If a setpoint is defined and enabled, but its batch sequence parameter is set to Off, the setpoint operates as a continuous setpoint even during batch sequences.



**NOTE:** *In applications which contain both batch setpoint routines and continuous setpoints, it is good practice to keep continuous setpoints separate from the batch sequence.*

**NOTE:** *Do not assign them the same digital output.*

**NOTE:** *Set the Access parameter On when creating and testing batch routines. Once the batching routine is complete and ready for production, Access can be set to Off to prevent changes to the configured setpoint value, or to Hide to prevent changing or viewing the value.*

Parameter	Description	Batch	Continuous
Off	Setpoint turned off/ignored		
Gross	Performs functions based on the gross weight; the target weight entered is considered a positive gross weight	X	X
Net	Performs functions based on the net weight; the target weight entered is considered a positive net weight value	X	X
Negative Gross	Performs functions based on the gross weight; the target weight entered is considered a negative gross weight	X	X
Negative Net	Performs functions based on the net weight; the target weight entered is considered a negative net weight value	X	X
Accumulate	Compares the value of the setpoint to the source scale accumulator; the accumulator setpoint is satisfied when the value of the source scale accumulator meets the value and conditions of the accumulator setpoint	X	X
Positive Relative	Performs functions based on a specified value above a referenced setpoint, using the same weight mode as the referenced setpoint	X	X
Negative Relative	Performs functions based on a specified value below a referenced setpoint, using the same weight mode as the referenced setpoint	X	X

Table 14-1. Setpoint Kinds

Parameter	Description	Batch	Continuous
Percent Relative	Performs functions based on a specified percentage of the target value of a referenced setpoint, using the same weight mode as the referenced setpoint; the actual target value of the Percent Relative setpoint is calculated as a percentage of the target value of the referenced setpoint	X	X
Pause	Pauses the batch sequence indefinitely; a Batch Start signal must be initiated to continue the batch process	X	
Delay	Delays the batch sequence for a specified time; the length of the delay (in tenths of a second) is specified on the Value parameter	X	
Wait Standstill	Suspends the batch sequence until the scale is at standstill	X	
Counter	Specifies the number of consecutive batch sequences to perform; place counter setpoints at the beginning of a batch routine	X	
Auto-Jog	Automatically checks the previous weight-based setpoint to verify the setpoint weight value is satisfied in a standstill condition <ul style="list-style-type: none"> <li>If the previous setpoint is not satisfied when at standstill, the <b>Auto-Jog</b> setpoint activates the digital output of the previous weight-based setpoint for a period of time, specified on the Value parameter (in tenths of a second)</li> <li>The Auto-Jog process repeats until the previous weight-based setpoint is satisfied when the scale is at standstill</li> </ul> <p><b>NOTE: The Auto-Jog digital output is typically used to signify an Auto-Jog operation is being performed.</b></p> <p><b>NOTE: Auto-Jog uses the digital output of the previous weight-based setpoint, and should not be assigned to the same digital output as the related weight-based setpoint.</b></p>	X	
Center of Zero	Monitors for a gross center of zero condition <ul style="list-style-type: none"> <li>The digital output associated with this setpoint kind is activated when the referenced scale is at center of zero</li> <li>No value is required for this setpoint</li> </ul>		X
In Motion	Monitors for an in-motion condition <ul style="list-style-type: none"> <li>The digital output associated with this setpoint is activated when scale is not at standstill</li> <li>No value is required for this setpoint</li> </ul>		X
In Range	Monitors for an in-range condition <ul style="list-style-type: none"> <li>The digital output associated with this setpoint is activated when the scale is within capacity range</li> <li>No value is required for this setpoint</li> </ul>		X
Batch in Process	Batch processing signal: <ul style="list-style-type: none"> <li>The digital output associated with this setpoint is activated whenever a batch sequence is in progress</li> <li>No value is required for this setpoint</li> </ul>		X
Timer	Tracks the progress of a batch sequence based on a timer <ul style="list-style-type: none"> <li>The timer value, in tenths of a second, determines the length of time allowed between start and end setpoints</li> <li>Start and End parameters are used to specify the start and end setpoints</li> <li>If the End setpoint is not reached before the timer expires, the digital output associated with this setpoint is activated</li> </ul>		X
Concurrent	Allows a digital output to remain active over a specified portion of the batch sequence <ul style="list-style-type: none"> <li><b>Type 1 (Value = 0):</b> The digital output associated with this setpoint becomes active when the Start setpoint becomes the current batch step and remains active until the End setpoint becomes the current batch step</li> <li><b>Type 2 (Value &gt; 0):</b> If a non-zero value is specified for the Value parameter, the value represents the timer, in tenths of a second, for this setpoint; The digital output associated with this setpoint becomes active when the Start setpoint becomes the current batch step and remains active until the timer expires</li> </ul>		X
Time of Day	Performs functions when the internal clock time of the indicator matches the specified setpoint time	X	X
Always	This setpoint is always satisfied; It is typically used to provide an endpoint for true/false branching batch routines	X	
Never	This setpoint is never satisfied; Used to branch to a designated setpoint in true/false branching batch routines in which the batch does not continue through the normal sequence of batch setpoints	X	

Table 14-1. Setpoint Kinds (Continued)

## 14.2 Batch Operations

Batches are controlled by digital inputs or EDP commands.

### Batch Run (or BATRUN EDP command)

If a Batch Run digital input is configured, it must be active (low) for a batch to be started, and for it to continue to run. If a batch is running and the input becomes inactive (high), it will stop the batch at the current batch setpoint and turn off all associated digital outputs.

### Batch Start (or BATSTART EDP command)

If the Batch Run digital input is active (low), or is not assigned, Batch Start will start a batch, resume a paused batch or resume a stopped batch. If the Batch Run digital input is inactive (high), Batch Start will reset the current batch.

### Batch Pause (or BATPAUSE EDP command)

The Batch Pause digital input will pause an active batch, turning off all associated digital outputs EXCEPT those associated with Concurrent and Timer setpoints, while the input is active (low). As soon as the Batch Pause digital input is made inactive (high), the batch will resume. BATPAUSE EDP command works the same, except the batch will not resume until a Batch Start signal is received.

### Batch Stop (or BATSTOP EDP command)

Stops an active batch at the current setpoint and turns off all associated digital outputs.

### Batch Reset (or BATRESET EDP command)

Stops and resets an active batch to the beginning of the process.



**WARNING:** To prevent personal injury and equipment damage, software-based interruptions must always be supplemented by emergency stop switches and other safety devices necessary for the application.

### 14.2.1 Batching Switch

The batching switch option (PN 19369) comes as a complete unit in an FRP enclosure, with legend plate, emergency stop, and a run/start/abort three-way switch.

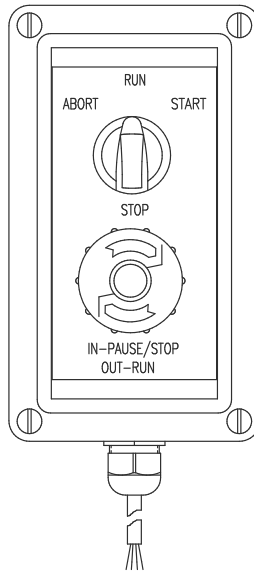


Figure 14-1. Batching Switch

Both switches are wired into the indicator's digital I/O terminal as shown in [Figure 14-2 on page 119](#). Each switch uses a separate digital input. Digital I/O Bit 1 must be set to Batch Start and Bit 2 must be set to Batch Run.

Once cables and switches have been connected to the indicator, use the setup switch to place the indicator in *Setup* mode. Use the Digital I/O menu ([Section 4.5.9 on page 63](#)) to configure digital input and output functions.

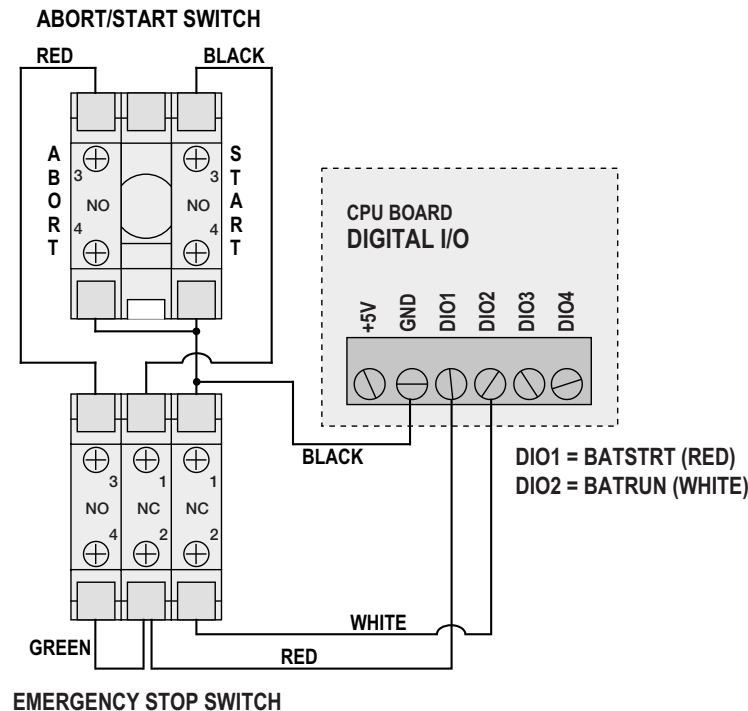


Figure 14-2. Batching Switch and Wiring Diagram Example

When configuration is complete, exit *Setup* mode. Initialize the batch by turning the three-way switch to ABORT, then unlock the STOP button (the STOP button must be in the OUT–RUN position to allow the batch process to run). The batching switch is now ready to use.



**WARNING:** If no digital input is assigned to Batch Run, batching proceeds as if Batch Run were always on (the batch starts when the three-way switch is turned to RUN, but the STOP button does not function).

To begin a batch process, turn the three-way switch to START momentarily. If the STOP button is pushed during the batch process, the process halts and the button locks in the IN–PAUSE/STOP position.

The START switch is ignored while the STOP button is locked in the IN–PAUSE/STOP position. The STOP button must be turned counterclockwise to unlock it, then released into the OUT–RUN position to enable the three-way switch.

To restart an interrupted batch from the step where it left off:

1. Unlock STOP button (OUT–RUN position).
2. Turn three-way switch to START.

To restart an interrupted batch from the first batch step:

1. Turn three-way switch to ABORT.
2. Unlock STOP button (OUT–RUN position).
3. Turn three-way switch to START.

To abort an interrupted batch:

1. Push the STOP button.
2. Turn three-way switch to ABORT.
3. Unlock STOP button (OUT–RUN position). A new batch can now be started.



**NOTE:** Use this procedure (or Batch Reset) to initialize the new batch routine following any change to the setpoint configuration.



## 14.3 Batching Examples

### 14.3.1 Example 1

The following example uses six setpoints to dispense material from a hopper in 100-lb batches and to automatically refill the hopper when its weight drops below 300 lb.

Bits 1 and 2 in the Digital I/O menu ([Section 4.5.9 on page 63](#)) are assigned to batch start and batch run functions: Batch Run must be on (low) before the Batch Start input starts the batch.

Slot 0, Bit 1 = Batch Start

Slot 0, Bit 2 = Batch Run

Batching = Manual

Setpoint 1 ensures the hopper has enough material to start the batch. If the hopper weight is 300 lb or higher, setpoint 1 is tripped.

Setpoint 1	Trip = Higher
Kind = Gross	Alarm = On
Value = 300	Batch = On

Setpoint 2 waits for standstill, then performs a tare to put the indicator into net mode.

Setpoint 2
Kind = Wait Standstill
Push Tare = On

Setpoint 3 is used as a reference (relative setpoint) for setpoint 4.

Setpoint 3	Trip = Higher
Kind = Net	Batch = Off
Value = 0	

Setpoint 4 is used to dispense material from the hopper. When the hopper weight falls to 100 lb less than its weight at the relative setpoint (setpoint 3), digital output 1 is set off.

Setpoint 4	Digital Output = 1
Kind = Negative Relative	Batch = On
Value = 100	Relative Setpoint Number = 3
Trip = Lower	

Setpoint 5 is used to evaluate the gross amount of material in the hopper after dispensing, and to maintain a minimum material level in the hopper. When the hopper weight falls below 300 lb, digital output 2 becomes active and the hopper is refilled to 1,000 lb.

Setpoint 5	Hysteresis = 700
Kind = Gross	Digital Output = 2
Value = 300	Batch = On
Trip = Higher	

Setpoint 6 is used to ensure the operation performed in setpoint 4 is completed within 10 seconds. The Start and End parameters identify the setpoints monitored by the Timer. If the Timer expires before Setpoint 5 starts, Digital Output 4 is turned on as an alarm to signal a process fault.

Setpoint 6	Start = 4
Kind = Timer	End = 5
Value = 100	Digital Output = 4



### 14.3.2 Example 2

The following example uses six setpoints to control a two-speed fill operation where both fast and slow feeds are on simultaneously.

Bits 1 and 2 in the Digital I/O menu ([Section 4.5.9 on page 63](#)) are assigned to Batch Start and Batch Run functions. Batch Run must be on (low) before the Batch Start input starts the batch.

Slot 0, Bit 1 = Batch Start

Slot 0, Bit 2 = Batch Run

Batching = Manual

Setpoint 1 ensures the scale is empty ( $0 \pm 2$  lb).

Setpoint 1                      Trip = Inband

Kind = Gross                      Band Value = 2

Value = 0                      Batch = On

Setpoint 2 checks for the weight of a container (>5 lb) placed on the scale.

Setpoint 2                      Trip = Higher

Kind = Gross                      Batch = On

Value = 5

Setpoint 3 waits for standstill, then tares the container weight, placing the indicator in net mode.

Setpoint 3

Kind = Wait Standstill

Push Tare = On

Setpoint 4 starts the fast fill operation. When the net weight reaches 175 lb, the setpoint trips and digital output 1 is set off.

Setpoint 4                      Trip = Higher

Kind = Net                      Digital Output = 1

Value = 175                      Batch = On

Setpoint 5 controls the slow fill operation. When the net weight reaches 200 lb, the slow fill is stopped, the indicator waits for standstill and performs a push print operation using the Setpoint Format ticket format.

Setpoint 5                      Push Print = Wait Standstill

Kind = Net                      Digital Output = 2

Value = 200                      Batch = On

Trip = Higher

Setpoint 6 is a continuous setpoint, used to allow the slow feed output to be on at the same time as the fast fill. The slow fill output (Digital Output 2) is turned on when Setpoint 4 (fast fill) starts and remains on until Setpoint 5 begins.

Setpoint 6                      Start = 4

Kind = Concurrent                      End = 5

Value = 0                      Digital Output = 2

## 15.0 Maintenance

The maintenance information in this manual is designed to cover aspects of maintaining and troubleshooting the 682 indicator. Contact the local Rice Lake Weighing Systems dealer if a problem requires technical assistance.



**NOTE:** Have the scale model number and serial number available when calling for assistance.

### 15.1 Maintenance Checkpoints

The scale must be checked frequently to determine when a calibration is required. It is recommended a zero calibration be checked every other day and a calibration checked every week for several months after installation. Observe the results and change the period between calibration checks, depending upon the accuracy desired.



**NOTE:** Establish a routine inspection procedure. Report changes in the scale function to the individual or department responsible for the scales' performance.

### 15.2 Field Wiring

If a problem with the wiring is suspected, check the electrical portion of the scale.

- Check for proper interconnections between the components of the system
- Check wiring meets all specifications in the installation drawings
- Check all wiring and connections for continuity, shorts and grounds using an ohmmeter with the scale off
- Check for loose connections, poor solder joints, shorted or broken wires and unspecified grounds in wiring; these issues cause erratic readings and shifts in weight readings
- Check all cable shields to ensure grounding is made at only the locations specified in the installation drawings

### 15.3 Troubleshooting Tips

Table 15-1 lists general troubleshooting tips for hardware and firmware error conditions.

Symptom	Possible Cause	Remedy
682 does not power up	Bad power supply	Check power supply; Check presence of AC or DC power – breaker tripped or unit unplugged; Power supply outputs around 12 VDC – replace if bad
Battery-backed corrupt error message at startup	Dead battery	Perform configuration reset then check for low battery warning on display; If battery is low, replace battery, perform another configuration reset, then reload files/configuration
ΛΛΛΛΛΛΛ or VVVVVVV	Over or under range scale condition	Check scale
Cannot enter <i>Setup</i> mode	Bad switch	Test switch
Serial port not responding	Wiring or Configuration error	Verify proper wiring and ensure port input trigger is set to command
A/D scale out of range	Scale operation Load cell connection Bad load cell	Check source scale for proper mechanical operation Check load cell and cable connection Check 682 operation with load cell simulator Check status of sense settings
Option card failure	Possible defective card or slot	Disconnect power, remove and reinstall card in slot, then apply power again

Table 15-1. Basic Troubleshooting

## 15.4 Battery Replacement

The battery life varies depending on use. It is recommended to replace the battery every three years, or sooner, if left powered off for extended periods of time to prevent data loss in the event of a power failure.

Use the Revolution configuration utility ([Section 11.0 on page 95](#)) or EDP commands ([Section 12.0 on page 96](#)) to store a copy of the 682 configuration on a PC before attempting battery replacement. The 682 configuration can be restored from the PC if data is lost.



**WARNING:** Risk of explosion if battery is replaced with an incorrect type. Dispose of batteries at appropriate waste collection centers at the end of their life cycle in accordance with local laws and regulations. Batteries and rechargeable batteries may contain harmful substances that should not be disposed of in household waste. Batteries may contain harmful substances including but not limited to: cadmium (Cd), lithium (Li), mercury (Hg) or lead (Pb). Users who dispose of batteries illegally shall face administrative sanctions as provided by law.



**IMPORTANT:** Use anti-static protection for grounding and to protect components from electrostatic discharge (ESD) when working inside the 682 enclosure. Procedures requiring work inside the 682 must be performed by qualified service personnel only.

A Phillips head screwdriver is required for battery removal.

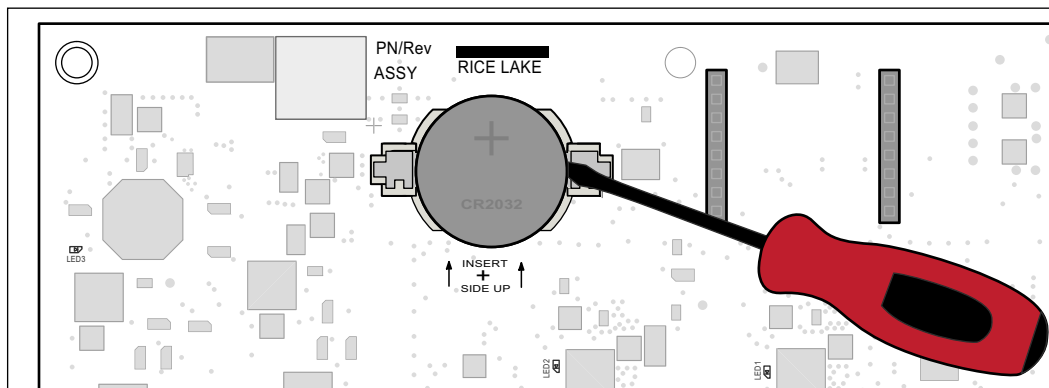


Figure 15-1. Non-Conductive Screw Driver Placement

To replace the battery, use the following procedure:

1. Disconnect power to the indicator.
2. Remove the backplate with the Phillips screwdriver as described in [Section 2.3 on page 14](#).
3. Locate the battery inserted in the CPU board. See [Section 2.6 on page 22](#).
4. Slide the battery out of position and remove with fingertips.
5. Slide the new replacement battery into the battery holder with the positive side up. See [Section 2.10 on page 25](#) for replacement battery details.
6. Replace the backplate.
7. Power the indicator.
8. Reset the time and date settings of the indicator. See [Section 3.4.15 on page 35](#) to set the time and [Section 3.4.16 on page 36](#) to set the date.

## 15.5 Board Replacement

Board replacement should only be done by a service technician.

**IMPORTANT:** Use anti-static protection for grounding and to protect components from electrostatic discharge (ESD) when working inside the 682 enclosure. Procedures requiring work inside the 682 must be performed by qualified service personnel only.

To replace a 682 board, use the following procedure:

1. Disconnect power to the indicator.
2. Remove backplate as described in [Section 2.3 on page 14](#).
3. Label connections for re-installation to board.
4. Disconnect all connections from the board.
5. Remove all screws securing the board.
6. Disconnect the overlay ribbon cable from the J26 connector and the display ribbon cable from the J27 connector on the reverse side of the board as it is lifted from the enclosure.
7. Use the J1-J5 connectors of the new replacement board to rest the board on the bottom edge of the enclosure opening.

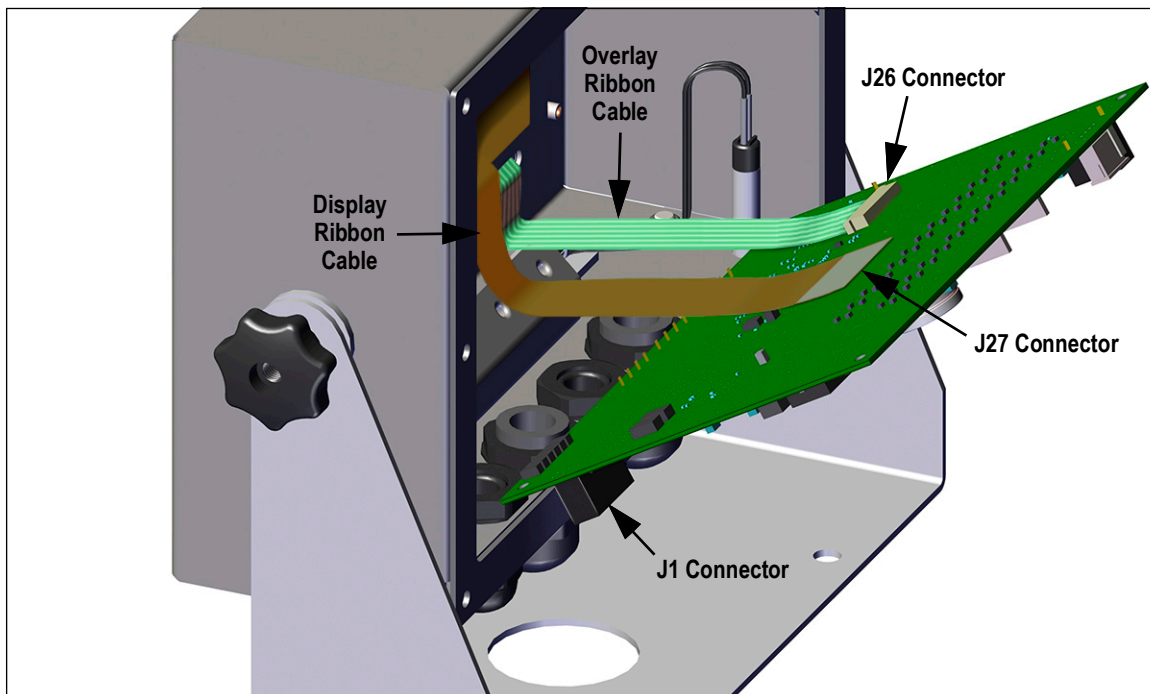


Figure 15-2. Replacement Board Installation

8. Press the end of the overlay ribbon cable up against the J26 connector while it is still closed. Open the J26 connector and then close it once the end of the overlay ribbon cable has seated itself inside of the connector.
9. Line up the display ribbon cable connector with the J27 connector and press the backside of the display ribbon cable end piece, so the connectors click together.
10. Place the new replacement board into the enclosure and secure with previously removed screws.
11. Reconnect all connections to the board. See [Section 2.6 on page 22](#) for details on the board connectors.

**IMPORTANT:** Always verify indicator has been returned back to a safe state with the proper installation of all connections and a complete functions test before reinstalling the backplate and returning the indicator back into service.

## 16.0 Appendix

### 16.1 Error Messages

The 682 indicator provides a number of error messages. When an error occurs, the message displays on the indicator.

#### 16.1.1 Displayed Error Messages

The 682 provides a number of front panel error messages to assist in problem diagnosis. [Table 16-1](#) lists these messages and their meanings.

Error Message	Description
-----	Overflow error – Weight value too large to be displayed
AAAAAAAA	Gross > overload limit – Gross value exceeds overload limit; Check configuration or signal input level; Overload can be caused by input signal > 45 mV or common mode voltage > 950 mV
VVVVVVV	Gross < underload limit – Gross value exceeds underload limit
Battery low	Displays every 30-seconds when battery is low
Waiting for 30 seconds of standstill	Displays when power up delay is active
Not allowed in motion	Displays when attempting to perform a function while weight is in motion, if in motion is not allowed for that function
Tare in motion not allowed	Displays when attempting to perform a tare while weight is in motion, if in-motion tares are not allowed
Tare not allowed	Displays when attempting to perform a tare, if a tare is not allowed
Negative tare not allowed	Displays when attempting to perform a negative tare, if a negative tare is not allowed
Keyed tare not allowed	Displays when attempting to perform a keyed tare, if a keyed tare is not allowed
Tare exceeding capacity not allowed	Displays when attempting to perform a tare larger than capacity, if it is not allowed
Multiple tares not allowed	Displays when attempting to perform a tare if a tare is already in the system, if tare is not configured to replace or remove
Must be in first interval to tare	Interval is currently within the second or third interval; Perform tare while in the first interval only
Keyed tare value must be in first interval	Keyed tare value is within the second or third interval; Keyed tare value must be within the first interval only
Duplicate ID not allowed	Displays when attempting to enter a Truck ID that already exists, if ID Overwrite is set to Disable
Invalid ID	Displays when attempting to enter an invalid Truck ID; Truck IDs can be up to 16 alphanumeric characters in length
Truck ID not found	Displays when attempting to enter a Truck ID at Weigh Out that has not been previously entered
Truck program disabled	Displays when attempting a Truck Mode function, when Truck Mode is set to Off
Truck program error	Generic error for the truck program
Invalid Index	Displays when attempting to delete a truck ID record with an invalid index
Invalid Weight	Displays when weigh-in/-out procedure weight is invalid
Record read error	Displays when an error occurs while reading from the microSD card or the CRC wasn't valid on the record
Record write error	Displays when an error occurs while writing to the microSD card
Initial zero failed	Displays when an attempt to perform an initial zero fails, only possible at startup
Please wait	Displays when calibrating
Alarm	Displays when a configured setpoint's ALARM action occurs

Table 16-1. 682 Error Messages

## 16.2 Audit Trail Support

Audit trail support provides tracking information for configuration and calibration events. To prevent potential misuse, all configuration and calibration changes are counted as change events.

Audit trail information can be printed from Revolution or by sending the DUMPAUDIT serial command. Revolution can be used to display audit trail information. The audit trail display includes the legally relevant (LR) version number (firmware version for the code which provides audit trail information), a calibration count and a configuration count.

See [Section 3.4.10 on page 33](#) for steps to view the Audit Trail counters.

## 16.3 Unit Conversion Factors

The 682 has the capability to mathematically convert a weight into many different types of units and instantly display those results with a press of the **Units** key. Secondary and Tertiary units, along with Custom Units can be configured in the Scale Format menu ([Section 4.5.2 on page 45](#)).



**NOTE: Multipliers are preconfigured within the indicator, unless a Custom Unit is applied.**

**Ensure the unit format is set appropriately for the scale capacity in the secondary and tertiary units.**

## 16.4 ZZ EDP Command

The ZZ EDP command can be used to remotely query which annunciators are currently displayed on the indicator front panel. The ZZ command returns a decimal number representing the LED annunciators currently lit ([Table 16-2](#)).

*Example: If the annunciator status value returned on the ZZ command is 145, the gross, standstill and lb annunciators are lit. The number 145 represents the sum of the values for the gross mode annunciator (16), the standstill annunciator (128) and the lb annunciator (1).*

Decimal Value	Annunciator
1	lb/primary units
2	kg/secondary units
4	Tare entered
8	Keyed tare entered
16	Gross
32	Net
64	Center of zero
128	Standstill

Table 16-2. Status Codes Returned on the ZZ Command

## 16.5 Continuous Data (Stream) Output Formats

When the trigger setting for a port is set to Stream Industrial (STRIND) or Stream Legal for Trade (STRLFT), data is continuously streamed from the appropriate port in one of the four fixed format options or a custom format option.

### Fixed Format Options:

- Rice Lake Weighing Systems ([Section 16.5.1](#))
- Cardinal ([Section 16.5.2](#))
- Avery Weigh-Tronix ([Section 16.5.3 on page 128](#))
- Mettler Toledo ([Section 16.5.4 on page 128](#))

### 16.5.1 Rice Lake Weighing Systems Stream Format (RLWS)

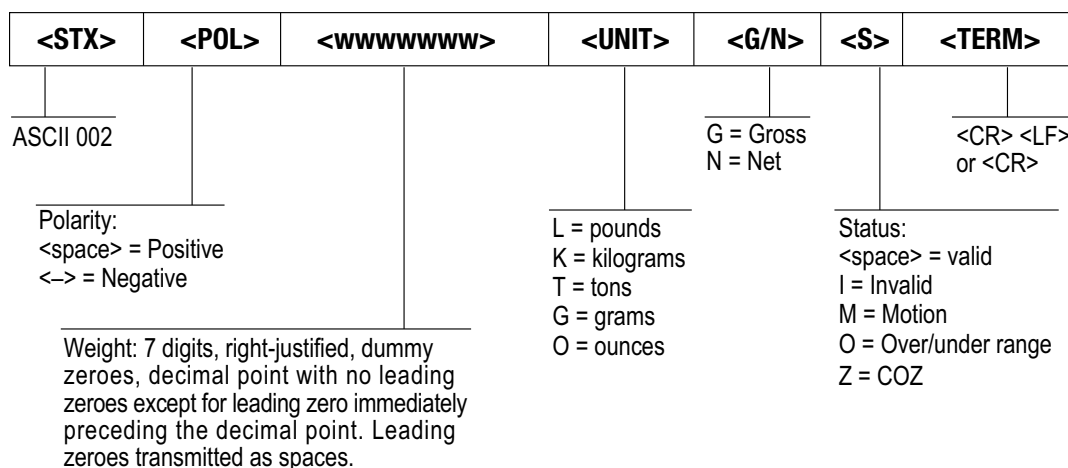


Figure 16-1. RLWS Stream Data Format

### 16.5.2 Cardinal Stream Format (Cardinal)

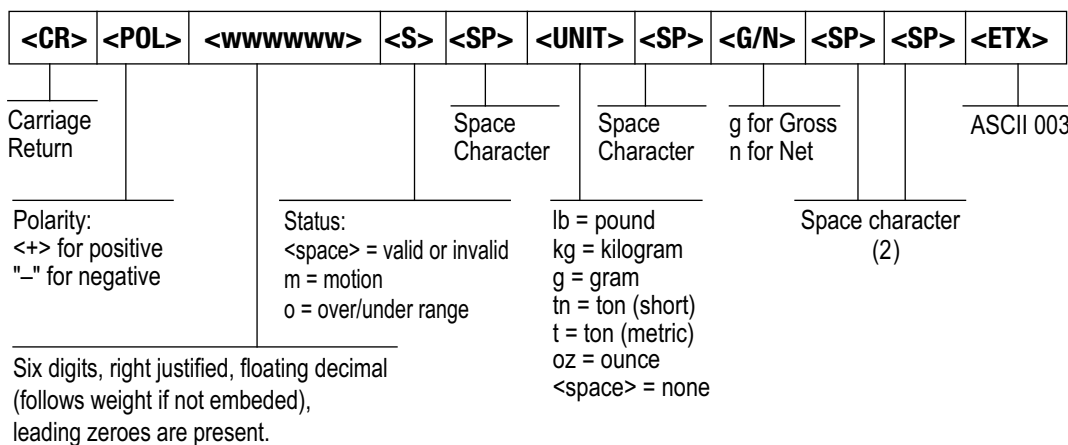


Figure 16-2. Cardinal Stream Data Format

### 16.5.3 Avery Weigh-Tronix Stream Format (Weigh-Tronix)

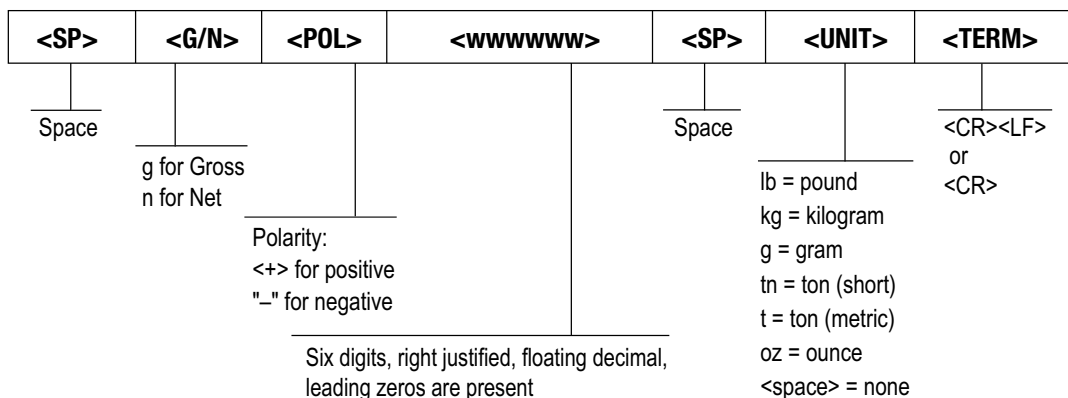
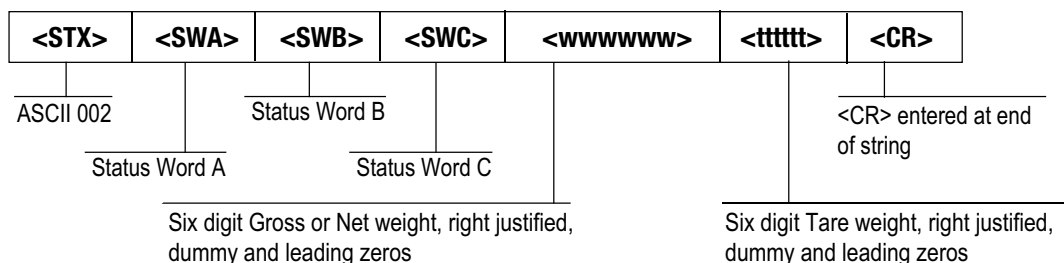


Figure 16-3. Weigh-Tronix Stream Data Format

### 16.5.4 Mettler Toledo Stream Format (Toledo)



**Status Word A:**

<b>7</b>	<b>6</b>	<b>5</b>	<b>4</b>	<b>3</b>	<b>2</b>	<b>1</b>	<b>0</b>
Parity	0	1	MUL1	MUL0	DP2	DP1	DP0

Even parity bit.  
Requires EDP Port setup.

Disp. Div.  
MUL1 MUL0 Multiplier  
0 1 x 1  
1 0 x 2  
1 1 x 5

**DP2 DP1 DP0 Fixed Zero/Dec. Pt. Location**

0 0 0	x 100	(2 fixed zeroes)
0 0 1	x 10	(1 fixed zero)
0 1 0	x 1	(No decimal point)
0 1 1	x 0.1	(1 decimal place)
1 0 0	x 0.01	(2 decimal places)
1 0 1	x 0.001	(3 decimal places)
1 1 0	x 0.0001	(4 decimal places)
1 1 1	x 0.00001	(5 decimal places)

**Status Word C: ASCII 20h (space)**

<b>7</b>	<b>6</b>	<b>5</b>	<b>4</b>	<b>3</b>	<b>2</b>	<b>1</b>	<b>0</b>
Parity	0	1	0	0	0	0	0

Even parity bit.  
Requires EDP Port setup.

**Status Word B:**

<b>7</b>	<b>6</b>	<b>5</b>	<b>4</b>	<b>3</b>	<b>2</b>	<b>1</b>	<b>0</b>
Parity	0	1					

Even parity bit.  
Requires EDP Port setup.

0 = lb  
1 = kg

0 = Stable  
1 = Motion

0 = In range  
1 = Out of range

0 = Positive indicated weight value  
1 = Negative indicated weight value

0 = Gross Display Mode  
1 = Net Display Mode

Figure 16-4. Toledo Stream Data Format



## 16.5.5 Minebea Stream Format (Minebea)

Data Output Format with 16 Characters (without Data Header) - Normal Operation																
Position	1	2	3	4	5	6	7	8	9	10	11	12	13	14	15	16
	+	*	D	D	D	D	D	D	D	D	*	U	U	U	CR	LF
or	-	*	D	D	D	D	D	D	D	D	*	U	U	U	CR	LF
or	*	*	*	*	*	*	*	*	*	*	*	*	*	*	CR	LR
+/-	Plus or minus sign															
*	Space															
D	Digit or Letter (max. 7 characters plus decimal point)															
U	Unit symbol (1 to 3 letters followed by 2-0 spaces)															
CR	Carriage return															
LF	Line feed															

Table 16-3. Minebea Stream Data Format

## 16.6 Custom Stream Formatting

The Custom stream format parameter can be configured in the Stream Format menu via the front panel. See [Section 4.5.7 on page 58](#) for the Stream Format menu structure. The indicator must be in setup mode ([Section 4.1 on page 40](#)) to access the Stream Format menu.

### Using the Front Panel

Use the Stream Format menu to customize the Custom parameter by changing the ASCII characters in the format string.

Setup ▼ to Configuration ► to Stream Format ▼ to Format (set to Custom) ► to Custom ▼ to format string entry

See [Section 3.3.2 on page 31](#) for the alphanumeric entry procedure to edit the format string.



**NOTE:** The 682 can send or receive ASCII characters; the character printed depends on the particular ASCII character set implemented for the receiving device. Some characters cannot be displayed on the 682 front panel, see the ASCII character chart in [Section 16.9 on page 135](#) for available characters and see [Section 13.3 on page 113](#) for a description of Non-Human Readable Characters.

For example, enter the following string of format tokens to recreate the standard RLWS stream format as a custom stream format: <2><P><W7.><U><M><S><CR><LF>

- <2> Sends ASCII character 2, or STX.
- <P> Sends the Polarity character.
- <W7.> Sends 7 weight digits, no leading zeros, with a floating decimal point as needed.
- <U> Sends the Units.
- <M> Sends the Mode.
- <S> Sends the Status.
- <CR> Sends a Carriage Return.
- <LF> Sends a Line Feed.

## Custom Stream Format Tokens

Format Identifier	Defined By	Description
<P[G   N   T]>	STRM.POS#n STRM.NEG#n	Polarity – Specifies positive or negative polarity for the current or specified (Gross/Net/Tare) weight on the source scale; Possible values are SPACE, NONE, + (for STR.POS#n) or – (for STR.NEG#n)
<U[P   S   T]>	STRM.PRI#n STRM.SEC#n STRM.TER#n	Units – Specifies primary, secondary or tertiary units for the current or specified weight on the source scale
<M[G   N   T]>	STRM.GROSS#n STRM.NET#n STRM.TARE#n	Mode – Specifies gross, net or tare weight for the current or specified weight on the source scale
<S>	STRM.MOTION#n STRM.RANGE#n STRM.OK#n STRM.INVALID#n STRM.ZERO#n	Status for the source scale – Default values and meanings for each status: <ul style="list-style-type: none"> <li>• STR.MOTION#n M In motion</li> <li>• STR.RANGE#n O Out of range</li> <li>• STR.OK#n &lt;space&gt; OK</li> <li>• STR.INVALID#n I Invalid</li> <li>• STR.ZERO#n Z COZ</li> </ul>
<UID>	UID	Unit ID number – Specifies the unit identification number as an alphanumeric value up to 6 characters long
<###>	--	To send an ASCII character; ### is a number 0 to 255; for example: <2> sends the ASCII character 2, Start of Text (STX) and the token <13> sends a Carriage Return
XXXX	--	To send literal characters; XXXX represents literal characters to include in the string by not including <>; for example: SCALE<W7.><U><CR><LF> will stream "SCALE 1234 L" with a weight of 1234 pounds
<B [-]n,...>	See descriptions below	Bit fields. Comma-separated sequence of bit field specifiers; Must be exactly 8-bits; minus sign (-) inverts the bit
B0	--	Always 0
B1	--	Always 1
B2	Configuration	=1 if even parity
B3	Dynamic	=1 if MODE=NET
B4	Dynamic	=1 if COZ
B5	Dynamic	=1 if standstill
B6	Dynamic	=1 if gross negative
B7	Dynamic	=1 if out of range
B8	Dynamic	=1 if secondary/tertiary
B9	Dynamic	=1 if tare in system
B10	Dynamic	=1 if tare is keyed
B11	Dynamic	=00 if MODE=GROSS =01 if MODE=NET =10 if MODE=TARE =11 (not used)
B12	Dynamic	=00 if UNITS=PRIMARY =01 if UNITS=SECONDARY =10 if UNITS=TERTIARY =11 (not used)
B13	Configuration	=00 (not used) =01 if current DSPDIV=1 =10 if current DSPDIV=2 =11 if current DSPDIV=5
B14	Configuration	=00 (not used) =01 if primary DSPDIV=1 =10 if primary DSPDIV=2 =11 if primary DSPDIV=5
B15	Configuration	=00 (not used) =01 if secondary DSPDIV=1 =10 if secondary DSPDIV=2 =11 if secondary DSPDIV=5

Table 16-4. Custom Stream Format Tokens

Format Identifier	Defined By	Description
B16	Configuration	=00 (not used) =01 if tertiary DSPDIV=1 =10 if tertiary DSPDIV=2 =11 if tertiary DSPDIV=5
B17	Configuration	=000 if current DECPNT=8888800      =100 if current DECPNT=88888.88 =001 if current DECPNT=8888880      =101 if current DECPNT=8888.888 =010 if current DECPNT=8888888      =110 if current DECPNT=888.8888 =011 if current DECPNT=888888.8      =111 if current DECPNT=88.88888
B18	Configuration	=000 if primary DECPNT=8888800      =100 if primary DECPNT=88888.88 =001 if primary DECPNT=8888880      =101 if primary DECPNT=8888.888 =010 if primary DECPNT=8888888      =110 if primary DECPNT=888.8888 =011 if primary DECPNT=888888.8      =111 if primary DECPNT=88.88888
B19	Configuration	=000 if secondary DECPNT=8888800      =100 if secondary DECPNT=88888.88 =001 if secondary DECPNT=8888880      =101 if secondary DECPNT=8888.888 =010 if secondary DECPNT=8888888      =110 if secondary DECPNT=888.8888 =011 if secondary DECPNT=888888.8      =111 if secondary DECPNT=88.88888
B20	Configuration	=000 if tertiary DECPNT=8888800      =100 if tertiary DECPNT=88888.88 =001 if tertiary DECPNT=8888880      =101 if tertiary DECPNT=8888.888 =010 if tertiary DECPNT=8888888      =110 if tertiary DECPNT=888.8888 =011 if tertiary DECPNT=888888.8      =111 if tertiary DECPNT=88.88888
<wspec [-] [0] digit [.] [digit]>	Scale weight	Weight for the source scale. <b>wspec</b> is defined as follows: <b>wspec</b> indicates whether the weight is the current displayed weight (W, w), gross (G, g), net (N, n) or tare (T, t) weight; Upper-case letters specify right-justified weights, lower-case are left-justified Optional /P, /S or /T suffixes can be added before the ending delimiter (>) to specify weight display in primary (/P), secondary (/S) or tertiary (/T) units [-] Enter a minus sign (-) to include sign for negative values [0] Enter a zero (0) to display leading zeros digit[.] [digit]  The first digit indicates the field width in characters; The decimal point only indicates a floating decimal; A decimal point with a following digit indicates fixed decimal with n digits to the right of the decimal; Two consecutive decimals send the decimal point even if it falls at the end of the transmitted weight field
<CR>	--	Carriage return
<LF>	--	Line feed

Table 16-4. Custom Stream Format Tokens (Continued)

## 16.7 Digital Filtering

Digital filtering is used to create a stable scale reading in challenging environments. The 682 allows selection of **Digital Rolling Average Filtering** (Section 16.7.1), **Adaptive Filtering** (Section 16.7.2 on page 132), **Damping** (Section 16.7.3 on page 133) or **Raw** for no filtering. See Section 4.5.1 on page 43 for configuration menu layout and the location of the Filter Chain Type parameter.

The scale's sample rate effects all types of filtering. The A/D sample rate is selected by the Sample Rate parameter. The A/D sample rate is the number of weight readings the indicator takes per second. This can be 6.25, 7.5, 12.5, 15, 25, 30, 50, 60 or 120 hertz (readings per second). Set the A/D sample rate to the lowest setting required for the application. Lower settings result in better stability.

### 16.7.1 Digital Rolling Average Filter (Average Only)

The digital rolling average filter uses mathematical averaging with three stages. These configurable stages control the effect of a single A/D reading on the displayed weight. When an A/D reading outside of a predetermined band is encountered, the digital rolling average filter is overridden and the display jumps directly to the new value.

#### Digital Filter Stages 1-3

The filter stages can each be set to a value of 1–256. The value assigned to each stage sets the number of readings received from the preceding filter stage before averaging. Setting the filter stages to 1 effectively disables the rolling filter.

A rolling average is passed to successive filtering stages for an overall filtering effect which is effectively a weighted average of the product of the values assigned to the filter stages (*Digital Filter Stage 1 x Digital Filter Stage 2 x Digital Filter Stage 3*) within a time frame corresponding to the sum of the values (*Digital Filter Stage 1 + Digital Filter Stage 2 + Digital Filter Stage 3*).

### Digital Filter Sensitivity and Digital Filter Threshold

The rolling averaging filter can be used by itself to eliminate vibration effects, but heavy filtering also increases settling time. The *Digital Filter Sensitivity* and *Digital Filter Threshold* parameters can be used to temporarily override filter averaging and improve settling time.

- *Digital Filter Sensitivity* specifies the number of consecutive A/D readings which must fall outside the *Digital Filter Threshold* before filtering is suspended
- *Digital Filter Threshold* sets a threshold value, in display divisions; When the specified number of consecutive A/D readings (*Digital Filter Sensitivity*) fall outside of this threshold, filtering is suspended; Set *Digital Filter Threshold* to *NONE* to turn off the filter override

### Digital Rolling Average Filter Procedure

1. In *Setup* mode, set the rolling filter stage parameters (*Digital Filter Stage 1-3*) to 1.
2. Set *Digital Filter Threshold* to *NONE*.
3. Return to *Weigh* mode.
4. Remove all weight from scale, then watch the indicator to determine the magnitude of vibration effects on the scale.
5. Record weight below which all but a few readings fall. This value is used to calculate the *Digital Filter Threshold* parameter in [step 8](#).  
*Example – if a heavy-capacity scale (10,000 x 5 lb) produces vibration-related readings of up to 50 lb, with occasional spikes up to 75 lb, record 50 as the threshold weight value.*
6. Place the indicator in *Setup* mode and set the filter stage parameters (*Digital Filter Stage 1-3*) to eliminate the vibration effects on the scale (leave *Digital Filter Threshold* set to *NONE*).
7. Find the lowest effect value for the *Digital Filter Stage 1-3* parameters.



**NOTE:** If needed, the digital filter cutout sensitivity (*Digital Filter Sensitivity*) and the digital filter cutout threshold (*Digital Filter Threshold*) can be used to reset the digital rolling average filter so the response to a rate change is faster.

8. Calculate the *Digital Filter Threshold* parameter value by converting the weight value recorded in [step 5](#) to display divisions (*Threshold\_Weight\_Value / Display\_Divisions*).  
*In the example in [step 5](#), with a threshold value of 50, and a display-division value of 5, set the Digital Filter Threshold parameter to 10 display divisions.*
9. Set the *Digital Filter Sensitivity* parameter high enough to ignore transient peaks. Longer transients (typically caused by lower vibration frequencies) cause more consecutive out-of-band readings; set the *Digital Filter Sensitivity* parameter higher to counter low frequency transients.

### 16.7.2 Adaptive Filter (Adaptive Only)

The adaptive filter has two settings, *Adaptive Filter Sensitivity* and *Adaptive Filter Threshold*. It maintains a running average of the A/D readings when the weight change remains less than the defined threshold value. The filter automatically applies less value to each successive A/D reading the longer the weight change is less than the threshold value. The amount of value given to the most recent A/D reading is determined by the sensitivity setting.

#### Adaptive Filter Sensitivity

*Adaptive Filter Sensitivity* can be set to *Heavy*, *Medium* or *Light*. A *Heavy* setting results in an output which is more stable to weight changes than the *Light* setting. A *Heavy* setting also results in small changes in weight data (a few grads) on the scale base to not be seen as quickly as with the *Light* setting.

If the difference in typical subsequent weight values on the scale are only a few display divisions, use a *Light* setting. On a truck scale where the changes in subsequent weight values are 100s of display divisions, a *Heavy* setting is more appropriate.

### Adaptive Filter Threshold

Set the *Adaptive Filtering Threshold* for the amount of observed instability in the system. This parameter can be set in the range of 0–2000 and is entered as a weight value. When a new sampled weight value is acquired, the adaptive filter compares the new value to the previous (filtered) output value.

If the difference between the new value and the previous output value is greater than the *Adaptive Filtering Threshold* parameter the adaptive filter is reset to the new weight value.

If the difference between the new value and the previous output value is less than the *Adaptive Filtering Threshold* parameter, the two values are averaged together using a weighted average. The weighted average is based on the amount of time the system has been stable, and selected *Adaptive Filter Sensitivity* sensitivity.

With the *Adaptive Filtering Threshold* set at zero, determine the amount of instability present. Enter this amount of weight instability to set the threshold of the adaptive filter. The adaptive filter is set to *OFF*, the *Adaptive Filtering Threshold* parameter is set to zero.

### 16.7.3 Damping Filter (Damping Only)

The damping filter is a simple filter which adjusts the amount of time it takes for a change in weight to be processed through the scale. The *Damping Value* parameter is a time interval specified in tenths of a second (10 = 1 second). This *Damping Value* is used to determine the amount of time it takes for the scale to reach its final weight output. When *Damping Value* is set to ten, a transition from 0 lb to 500 lb on the scale takes one second. The closer the weight gets to its final amount, the slower the weight changes on the display.

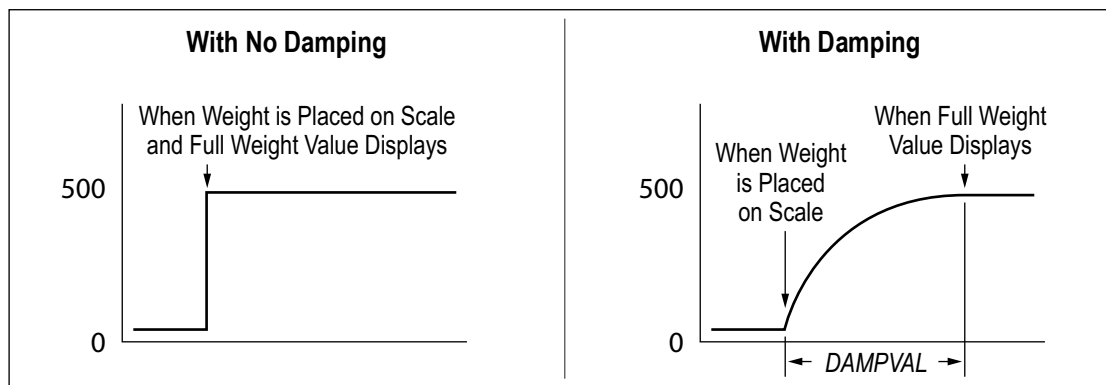


Figure 16-5. 500 lb Displayed Weight Progression

## 16.8 Regulatory Mode Functions

Regulatory Parameter	Weight On Scale	Tare In System	Front Panel Key Tare	Front Panel Key Zero
NTEP	Zero	No	"0000000"	Zero
		Yes	Clear tare	Zero
	Negative	No	No action	Zero
		Yes	Clear tare	Zero
	Positive	No	Tare	Zero
		Yes	Tare	Zero
Canada	Zero	No	"0000000"	Zero
		Yes	Clear tare	Clear tare
	Negative	No	No action	Zero
		Yes	Clear tare	Clear tare
	Positive	No	Tare	Zero
		Yes	No action	Clear tare
OIML	Zero	No	"0000000"	Zero
		Yes	Clear tare	Zero and Clear tare
	Negative	No	No action	Zero
		Yes	Clear tare	Zero and Clear tare
	Positive	No	"0000000"	Zero
		Yes	Tare	Zero and Clear Tare
Australia	Zero	No	"0000000"	Zero
		Yes	Clear tare	Zero and Clear tare
	Negative	No	No action	Zero
		Yes	Clear tare	Zero and Clear tare
	Positive	No	"0000000"	Zero
		Yes	Tare	Zero and Clear Tare
NOTE: Australia mode does not display capacity and count-by with the weight value.				
None	Zero	No	"0000000"	Zero
		Yes	Clear tare	Clear tare
	Negative	No	No action	Zero
		Yes	Clear tare	Clear tare
	Positive	No	Tare	Zero
		Yes	Clear tare	Clear tare

Table 16-5. Tare and Zero Key Functions for Regulatory Mode Parameter Settings

## 16.9 ASCII Character Chart

Table 16-6 is provided for reference when specifying print format strings. The actual character printed depends on the character mapping used by the output device.

Control	ASCII	Dec	Hex	ASCII	Dec	Hex	ASCII	Dec	Hex	ASCII	Dec	Hex
Ctrl-@	NUL	00	00	space	32	20	@	64	40	`	96	60
Ctrl-A	SOH	01	01	!	33	21	A	65	41	a	97	61
Ctrl-B	STX	02	02	"	34	22	B	66	42	b	98	62
Ctrl-C	ETX	03	03	#	35	23	C	67	43	c	99	63
Ctrl-D	EOT	04	04	\$	36	24	D	68	44	d	100	64
Ctrl-E	ENQ	05	05	%	37	25	E	69	45	e	101	65
Ctrl-F	ACK	06	06	&	38	26	F	70	46	f	102	66
Ctrl-G	BEL	07	07	'	39	27	G	71	47	g	103	67
Ctrl-H	BS	08	08	(	40	28	H	72	48	h	104	68
Ctrl-I	HT	09	09	)	41	29	I	73	49	i	105	69
Ctrl-J	LF	10	0A	*	42	2A	J	74	4A	j	106	6A
Ctrl-K	VT	11	0B	+	43	2B	K	75	4B	k	107	6B
Ctrl-L	FF	12	0C	,	44	2C	L	76	4C	l	108	6C
Ctrl-M	CR	13	0D	-	45	2D	M	77	4D	m	109	6D
Ctrl-N	SO	14	0E	.	46	2E	N	78	4E	n	110	6E
Ctrl-O	SI	15	0F	/	47	2F	O	79	4F	o	111	6F
Ctrl-P	DLE	16	10	0	48	30	P	80	50	p	112	70
Ctrl-Q	DC1	17	11	1	49	31	Q	81	51	q	113	71
Ctrl-R	DC2	18	12	2	50	32	R	82	52	r	114	72
Ctrl-S	DC3	19	13	3	51	33	S	83	53	s	115	73
Ctrl-T	DC4	20	14	4	52	34	T	84	54	t	116	74
Ctrl-U	NAK	21	15	5	53	35	U	85	55	u	117	75
Ctrl-V	SYN	22	16	6	54	36	V	86	56	v	118	76
Ctrl-W	ETB	23	17	7	55	37	W	87	57	w	119	77
Ctrl-X	CAN	24	18	8	56	38	X	88	58	x	120	78
Ctrl-Y	EM	25	19	9	57	39	Y	89	59	y	121	79
Ctrl-Z	SUB	26	1A	:	58	3A	Z	90	5A	z	122	7A
Ctrl-[	ESC	27	1B	;	59	3B	[	91	5B	{	123	7B
Ctrl-\	FS	28	1C	<	60	3C	\	92	5C		124	7C
Ctrl-]	GS	29	1D	=	61	3D	]	93	5D	}	125	7D
Ctrl-^	RS	30	1E	>	62	3E	^	94	5E	~	126	7E
Ctrl-_	US	31	1F	?	63	3F	_	95	5F	DEL	127	7F

Table 16-6. ASCII Character Chart

## 17.0 Compliance



### EU DECLARATION OF CONFORMITY

EU-KONFORMITÄTSERKLÄRUNG  
DÉCLARATION UE DE CONFORMITÉ

Rice Lake Weighing Systems  
230 West Coleman Street  
Rice Lake, Wisconsin 54868  
United States of America

**RICE LAKE**  
WEIGHING SYSTEMS

**Type/Typ/Type:** 680, 680HE and 682 indicator series

English We declare under our sole responsibility that the products to which this declaration refers to, is in conformity with the following standard(s) or other regulations document(s).

Deutsch Wir erklären unter unserer alleinigen Verantwortung, dass die Produkte auf die sich diese Erklärung bezieht, den folgenden Normen und Regulierungsbestimmungen entsprechen.

Francais Nous déclarons sous notre responsabilité que les produits auxquels se rapporte la présente déclaration, sont conformes à la/aux norme/s suivante ou au/aux document/s normatif/s suivant/s.

EU Directive	Certificates	Standards Used / Notified Body Involvement
22014/35/EU LVD	-	680: IEC 61010-1:2010+A1:2016 682, 680HE: EN 62368-1:2014 + A11:2017
2014/30/EU EMC	-	EN 61326-1:2013, EN 61000-3-3:2013, EN 61000-6-2, EN 61000-6-4, EN55011:2009/A1:2010
2014/53/EU RED	-	EN 301 489-17 V3.2.4, EN 300 328 V2.2.2, EN 301 893 V2.1.1
2011/65/EU RoHS	-	EN 50581:2012

Signature: Brandi Harder

Place: Rice Lake, WI USA

Name: Brandi Harder

Date: March 30, 2022

Title: Quality Manager





## UK DECLARATION OF CONFORMITY

Rice Lake Weighing Systems  
230 West Coleman Street  
Rice Lake, Wisconsin 54868  
United States of America



**Type:** 680, 680HE and 682 indicator series

English We declare under our sole responsibility that the products to which this declaration refers to, is in conformity with the following standard(s) or other regulations document(s).

UK Regulations	Certificates	Standards Used / Approved Body Involvement
2016/1101 Low Voltage	-	680: IEC 61010-1:2010+A1:2016 682, 680HE: EN 62368-1:2014 + A11:2017
2016/1091 EMC	-	EN 61326-1:2013, EN 61000-3-3:2013, EN 61000-6-2, EN 61000-6-4, EN55011:2009/A1:2010
2017/1206 Radio	-	EN 301 489-17 V3.2.4, EN 300 328 V2.2.2, EN 301 893 V2.1.1
2012/3032 RoHS	-	EN 50581:2012

Signature: Brandi Harder

Place: Rice Lake, WI USA

Name: Brandi Harder

Date: March 30, 2022

Title: Quality manager

## 18.0 Specifications

### Power

AC line voltage:	100–240 VAC
Frequency:	50–60 Hz
DC line voltage:	9–36 VDC

### Power Consumption

~3.2 W (AC) with one 350  $\Omega$  load cell, 15 W max  
 ~4 W (AC) with four 350  $\Omega$  load cells or eight 700  $\Omega$  load cells

### Excitation Voltage

10 VDC bi-polar ( $\pm 5$  VDC), 8 x 350  $\Omega$  or 16 x 700  $\Omega$  load cells

### Analog Signal Input Range

-5 mV to +70 mV

### Analog Signal Sensitivity

Minimum:	0.3 $\mu$ V/graduation
Recommended:	1 $\mu$ V/graduation

### A/D Sample Rate

6.25–120 Hz, software selectable

### Resolution

Internal:	8,000,000 counts
Display:	1,000,000

### System Linearity

Within 0.01% full scale

### Digital I/O

Four configurable I/O (5 V logic)

### Communication Ports

Two RS-232 (three-wire)  
 RS-485/422 (two-wire or four-wire)  
 Micro USB (device)  
 Ethernet TCP/IP (10/100)  
 Wi-Fi  
 Bluetooth®

### Status Annunciators

Zero, Stable, Gross/Net, Tare, Wi-Fi, Bluetooth®

### Display

Five-inch LCD, 800 x 480 pixels, 500 NIT

### Keys/Buttons

Flat membrane panel, tactile feel  
 18 buttons plus 5 softkeys and power

### Temperature Range

Legal:	14° F to 104° F (-10° C to 40° C)
Industrial:	14° F to 122° F (-10° C to 50° C)

### Rating / Material

Rating:	IP69 (IP66 with RJ45 option)
Material:	AISI 304 Stainless Steel

### Dimensions (W x H x D)

Indicator and stand:	11.6 in x 8.6 in x 4.0 in (29.47 cm x 21.85 cm x 10.16 cm)
Indicator and stand: (with RJ45 option)	11.6 in x 8.6 in x 4.5 in (29.47 cm x 21.85 cm x 11.43 cm)

### Weight

6.25 lb (2.84 kg)

### Warranty

Two-year limited warranty

### Certifications and Approvals



#### NTEP

CoC Number 19-021  
 Accuracy Class: III / IIIL;  $n_{max}$ : 10000



#### Measurement Canada

Approval AM-6121C  
 Accuracy Class: III / IIIHD;  $n_{max}$ : 10000



#### OIML

File Number: R76/2006-A-NL1-19.56  
 Accuracy Class: IIII / IIII;  $n_{max}$ : 10000



#### UL Listed

File Number: E151461







© Rice Lake Weighing Systems Content subject to change without notice.

230 W. Coleman St. • Rice Lake, WI 54868 • USA USA: 800-472-6703 • International: +1-715-234-9171