

TPW

Pallet truck with integrated scale

USER, INSTALLATION, MAINTENANCE INSTRUCTIONS - v4

ENGLISH

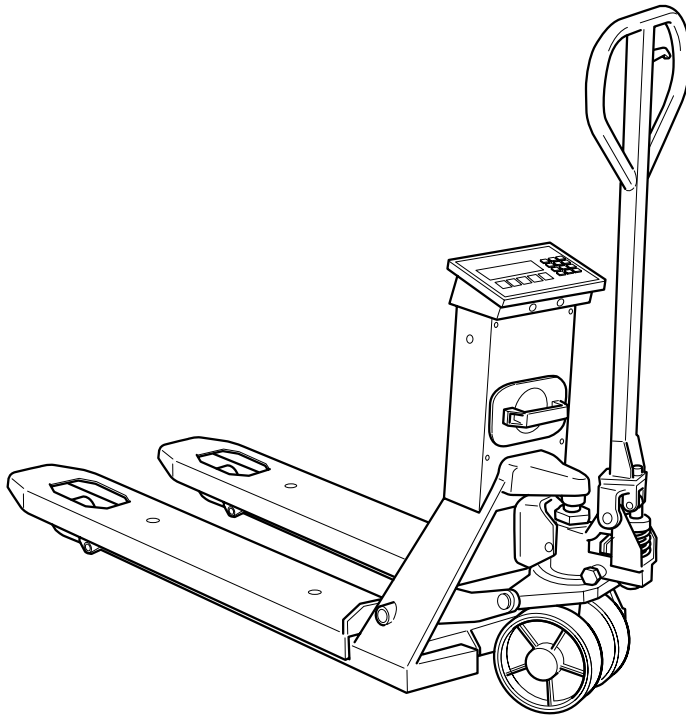

Index

IDENTIFICATION	8
Identification of the Manufacturer	8
Machine identification	8
Identification plate	8
EC Declaration of Conformity	9
Reference directives	10
PRELIMINARY INFORMATION	11
Recipients	11
Supply and storage	11
Updates	11
Language	12
Operators	12
Symbols used inside the manual	12
Personal protective equipment	13
Warranty	14
SAFETY DEVICES	15
Noise	15
Vibrations	15
Residual risks	15
Safety pictograms applied to the machine	16
DESCRIPTION	17
Intended use (correct)	17
Reasonably foreseeable misuse	17
Obligations and prohibitions	18
Operator obligations	18
Operator prohibitions	18
Technical data	19
Environmental conditions permitted	22
Main components	23

Rechargeable battery	24
Optional components	25
PACKAGING AND HANDLING	27
Packaging and handling warnings	27
Packaging	28
Packaging handling	28
Packaging removal	29
Packaging disposal	29
ASSEMBLY	30
Assembly warnings	30
Assembly procedure	31
Descent adjustment	35
COMMANDS	36
Tiller commands	36
Display	37
Keyboard types	38
USE	40
General warnings for correct use	40
Pallet truck conditions	42
Checks before use	43
Display switch-on	43
Pallet truck positioning	44
Load lifting and weight reading	44
How to replace the roll	45
Customisable printouts	45
BASIC SCALE FUNCTIONS	46
Start-up - On	46
Shutdown - Off	46
Zero	46

Display brightness adjustment	47
Automatic tare	47
Tare deletion	48
Set a known tare value (PT)	48
Print	49
Metrics	50

ADDITIONAL FUNCTIONS FOR MODELS WITH NUMBER KEYPAD 51

30-tare log	51
Automatic tare deletion	52
Number IDs	53
Date and time	54
Print (and reprint of last receipt)	55
Metrics	56

ADVANCED SCALE FUNCTIONS 57

How to access the function menu	57
Horizontal accumulator	58
Mixing several components	60
Piece count	62
Weight check	65
Exchange between net weight and gross weight	69
Percentage weighing	70
Unit of measurement conversion	73

METROLOGICAL SCALE INFORMATION 75

MAINTENANCE 76

Maintenance warnings	76
Scheduled maintenance	77
Scheduled maintenance table	77
Oil level top-up	78
Tank top-up for models with pump with plug	78

Tank top-up by means of syringe for models with mono-block pump	79
Unscheduled maintenance	80
TROUBLESHOOTING CASES	81
<hr/>	
Error messages	83

Dear Customer, Thank you for choosing a **DINI ARGEO** product.

The manual weighing pallet truck that you have purchased is ideal for handling and weighing pallets or standardised containers directly where they are located, saving you time and money.

It is equipped with high performance weighing electronics, precise and durable, and features a multifunctional program that can help you perform your daily tasks. Before using the instrument, please read this instruction manual carefully in order to be able to use it in complete safety and to learn about all of the functions it offers.

Safety information - Warnings

The safety precautions described in this manual, marked with the  symbol, must be followed during all installation, use, maintenance or repair stages of the weighing system.

Any use other than that reported in this manual, as well as not following the safety precautions, relieves the manufacturer from any responsibility and will void the product warranty.

- Read this manual carefully before carrying out any handling operations or lifting any loads.
- This pallet truck is designed to weigh exclusively on standardised pallets.
- With approved scale, you can perform weighing on EUR-EPAL pallet 800x1200mm (ref. Standards UIC 435-2 and UIC 435-4).
- NEVER load the scale beyond the maximum capacity stated on the plate of the weight readout instrument.
- IT IS forbidden to use the scale in environments where there is the danger of fire or explosion.
- Do not load the forks when they are raised, not even partially.
- Before using the pallet truck ensure it is in perfect working order.
- To achieve a correct weighing result, the forks need to be raised by at least 5-10 cm (Paragraph “**Load lifting and weight reading**” ref.).
- Do not expose the pallet truck to atmospheric agents (sun, rain, etc.).
- Use the pallet truck in non-condensing environments with moderate temperature and humidity levels
- Use the pallet truck where there are no vibrations.
- Carefully read and apply the aforementioned description of the weight indicator.
- To clean the pallet truck, avoid the use of solvents or aggressive substances.
- It is forbidden to make any modifications to the truck if not authorised by the manufacturer.
- It is forbidden to use the pallet truck when it no longer fulfils the safety criteria.
- It is forbidden to use flammable products to clean the truck.
- Except with specific models, it is forbidden to wash the pallet truck with direct jets of water.
- Do not pour liquids on the indicator.
- Anything not specifically described in this manual is to be considered improper use of the equipment.

i



- The crossed out wheelee bin symbol on the product shows that it must be brought to appropriate separate waste collection centres at the end of its life cycle or returned to the dealer when purchasing a new equivalent product.
- Proper separate collection to then send the product to recycling contributes to preventing possible negative effects on the environment and to health and promotes recycling. Users who dispose of the product illegally shall face administrative sanctions as provided for by law.

IDENTIFICATION

Identification of the Manufacturer

Manufacturer **DINI ARGEO s.r.l.**
Address **Via della Fisica, 20**
41042 Spezzano di Fiorano Mod.se (MO) - Italy
Tel. **+39 0536 843418** Fax **+39 0536 843521**
info@diniargeo.com

Machine identification

Machine **PALLET TRUCK WITH INTEGRATED SCALE**
Model **TPWXX**

Identification plate

The machine is equipped with an identification plate positioned in the upper part of the column.

The identification details of the machine, to be cited to the Support Centre if required, are provided on the plate.

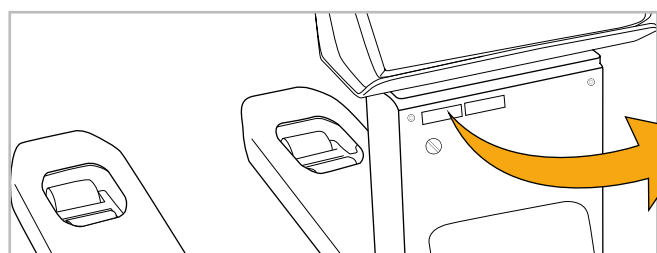

Mod. TPWLKP-5
Sn 0100574294

UK 2945
6V DC

CE
III

Dini Argeo - v. Fisica, 20 - 41042 Fiorano (MO) Italy

	B1W1	B1W2	B1W3
Max	500 kg	1000 kg	2000 kg
Min	4 kg	10 kg	20 kg
e =	0.2 kg	0.5 kg	1 kg



WARNING!

It is strictly forbidden to remove the CE identification plate and/or replace it with other plates.
If, for accidental reasons, the plate is damaged or removed, the customer must inform the Manufacturer.

EC Declaration of Conformity

The EC Declaration of Conformity is available on: www.diniargeo.com



DICHIARAZIONE DI CONFORMITA'
DECLARATION OF CONFORMITY
ERKLÄRUNG DER KONFORMITÄT
DECLARACION DE CONFORMIDAD
DECLARACION DE CONFORMIDAD



Fabbricante: Manufacturer: Hersteller: Fabricant: Fabricante:	DINI AR GEO srl Via della Fisica,20 Fiorano Modenese (MO) Italy
Modello: Model: Modell: Modèle: Modelo:	TPW20APM-2
Anno di costruzione: Manufacturing year: Herstellungsjahr: Année de fabrication: Año de construcción:	2018
Numero di serie: Serial number: Seriennummer: Numéro de série: Número de serie:	0100611649

E' conforme alle direttive:
-Conforms to the directives / Konform mit folgenden Richtlinien ist: / Est conforme aux directives: / Es conforme a las directivas:

2014/30/EU - Compatibilità Elettromagnetica

-Electromagnetic Compatibility / Elektromagnetische Kompatibilität / La compatibilità Electromagnétique / Compatibilidad Electromagnética

-Con riferimento alle norme armonizzate:

-With reference to these harmonized norms: / Mit Bezug auf die Normen: / En référence aux normes harmonisées: / Con referencia a las normas armonizadas:

EN 61000-6-2 / 2005; EN 61000-6-4 / 2007 / A1:2011; EN 61326-1 / 2013; EN 55011 / 2009)

2006/42/CE - Macchine

-Machines / Maschinen / Machines / Máquinas

UNI EN 13155 / 2009 ; UNI EN 13889

-Only for / Nur für / Seulement pour / Solo per MCW/TPW

Dichiara inoltre che:

Declares also that: / Der Hersteller erklärt außerdem, dass: / Déclare également que: / Declara también que:

-La persona autorizzata a costituire il fascicolo tecnico presso la sede del fabbricante è la Direzione Tecnica.

The person authorised to compose the technical file at the premises of the manufacturer is the Technical Management. / Die autorisierte Person, die die technischen Dokumente im Firmensitz des Herstellers verwaltet, ist das technische Management. / La personne autorisée à constituer le dossier technique chez la siège du fabricant est le directeur technique. / La persona autorizada a constituir el expediente técnico en la sede del fabricante es la Dirección Técnica.

Fiorano Mod.se (MO) Italy,14/03/2018	Firma/Signature/Unterschrift President
--------------------------------------	---

Rev. 2



Reference directives

The machine supplied by **DINI ARGEO** does not fall within one of the categories of machines listed in Annex IV of the Directive; therefore, for the purposes of certifying conformity of the machinery with the provisions of this Directive, **DINI ARGEO** shall apply the conformity assessment procedure with internal check on the manufacture of the machinery, as set out in Annex VIII.

To certify the conformity of the machine with the provisions of the Directive, **DINI ARGEO** before placing it on the market, has carried out the risk assessment in order to verify compliance with the essential health and safety requirements of the Directive as well as the tests and the checks required by the reference standards applied.

The technical construction file has been compiled in compliance with the provisions of Annex VII of **Directive 2006/42/EC** and is available for inspection by supervisory authorities upon a reasoned request, as required by the laws in force on the matter.

DINI ARGEO s.r.l. then places the machine on the market, constituting it with:

- CE Marking
- EC Declaration of Conformity
- Instruction manual for use, installation and maintenance (Documentation drawn up according to section 1.7.4 of the Machinery Directive 2006/42/EC)

please note that the machine has been designed according to the following Directives:

- **2006/42/EC Machinery Directive**
- **2014/30/EU Electromagnetic Compatibility Directive**

And that the following harmonised standards have been applied:

- **EN 61000-6-2 / 2005**
- **EN 61000-6-4 / 2007 / A1:2011**
- **EN 61326-1 / 2013**
- **EN 55011 / 2009**
- **UNI EN 13155 / 2009**
- **UNI EN 13889**

PRELIMINARY INFORMATION

Recipients

The manual is intended for operators responsible for using and managing the machine throughout all its technical lifespan stages. It contains the topics referring to the correct use of the machine, in order to maintain its functional and qualitative characteristics unchanged over time. All information and warnings for correct use in complete safety are also provided.

The manual, similarly to the EC compliance certificate, is an integral part of the machine and must always accompany it if moved or resold. It is the responsibility of the user to keep this documentation intact, to allow consultation, throughout the lifespan of the machine itself.

Supply and storage

The manual is available in electronic **format** on: www.diniargeo.com

Store this manual supplied with the machine, in order for it to be easily consulted by the operator.

The manual is an integral part for safety purposes, therefore:

- **it must be kept intact** (in all its parts). Should it be lost or damaged, it is required to request a copy immediately.
- **it must follow the machine until demolition** (even in case of movements, sale, lease, rental, etc....);

DINI ARGEO declines any liability for improper use of the machine and/or damage caused as a result of operations not covered by the technical documentation.

Updates

Should the machine require functional modifications or replacements, the revision or update of the manual is the responsibility of the Manufacturer. The Manufacturer is responsible for the delivery of the update of the manual.

The user is also responsible for ensuring that, if the present document is modified by the Manufacturer, only the updated versions of the manual are actually present in the points of use.

Language

The original manual has been drawn up in **Italian**.

Any translations into additional languages must be carried out starting from the original instructions.



The Manufacturer considers himself responsible for the information contained in the original instructions; translations in different languages cannot be fully verified, therefore if an incongruity is detected, it is required to follow the original text or contact the Support Centre.

Operators

In order to establish with certainty what are the skills and qualifications of the operators involved in the various tasks (commissioning, cleaning, scheduled maintenance), refer to the following table:

Qualification	Description
OPERATOR	<p>Personnel of the user trained and qualified to use and run the machine for production purposes for the activities for which it was built and supplied.</p> <p>They must be able to perform all the operations required for proper functioning of the machine and for the safety of themselves or of any collaborators. They must have proven experience in the correct use of these types of machines and be trained, informed and instructed in this regard. In case of doubt, they must report any anomaly to their superior.</p> <p>Note: they are not authorised to carry out any maintenance operation.</p>
MECHANICAL MAINTENANCE TECHNICIAN	<p>Qualified technician able to perform preventive/corrective maintenance on all mechanical parts of the machine subject to maintenance or repair.</p> <p>Qualified technician able to access all machine parts for visual analysis, checking the equipment status, adjustments and calibrations.</p> <p>Note: they are not authorised to operate on live electrical systems (if any).</p>
MANUFACTURER'S TECHNICIAN	<p>Technician qualified by the Manufacturer and/or their distributor for complex operations, as they are aware of the production cycle of the machine.</p> <p>This person operates according to the user's requests.</p>





Symbols used inside the manual

Symbol	Description
	Symbol used to identify important warnings for the safety of the operator and/or machine.
	Symbol used to identify information of particular importance within the manual. The information also concerns the safety of personnel involved in using the machine.

Personal protective equipment

When working near the machine, both for assembly operations and for maintenance and/or adjustment, it is strictly required to comply with the general accident-prevention regulations, therefore it will be important to use the **personal protective equipment (PPE)** required for each individual operation.

The complete list of **personal protective equipment (PPE)** that may be required for the different procedures is provided below:

Symbol	Description
	Obligation to use safety or insulating gloves. Indicates a requirement for the personnel to use safety or insulating gloves.
	Obligation to use safety goggles. Indicates a requirement for the personnel to use safety goggles.
	Obligation to use safety footwear. Indicates a requirement for the personnel to use safety footwear.
	Obligation to use noise protection devices. Indicates a requirement for the personnel to use earplugs or earmuffs for hearing protection.
	Obligation to use safety clothing. Indicates a requirement for the personnel to wear the specific safety clothing.

The clothing of those operating or maintaining the line must comply with the essential safety requirements defined by the **EU Reg.2016/425** and with the laws in force in the country where the line is installed.

Warranty



IMPORTANT!

The complete warranty terms are set out in the sales contract.

The conditions foreseen in the commercial contract (if different) have priority over what is provided in this section.

The warranty is **subject** to the following general conditions:

- the machine must be used within the limits stated in the contract and provided in the technical documentation.
- maintenance must be carried out in the times and in the ways required by the manual, using original **DINI ARGEO** spare parts and entrusting the operations to qualified personnel.

The warranty is **void** in case of:

- failure to comply with the safety regulations;
- removal or tampering with control and safety devices;
- improper use of the machine;
- use of the machine by untrained and/or unauthorised personnel or failure to comply with the skills of the various operators, as indicated in the manual;
- modifications or repairs made by the user without the Manufacturer's written authorisation;
- partial or total failure to comply with the instructions;
- lack of maintenance;
- use of non-original spare parts;
- exceptional events such as flooding, fires (if not caused by the machines).

SAFETY DEVICES

Noise

Noise measurements have been carried out in accordance with the provisions of standards **UNI EN 11200** and **UNI EN ISO 3746**.

During the operating cycles, under conditions of perfect functioning and maintenance and on a smooth industrial surface, **noise exposure of the personnel is less than 70 dB**.

It is the user's responsibility to apply the resulting preventive and protective measures, in compliance with the legislation of the country where the machine is installed and used.

Vibrations

The vibrations produced by the machine, according to its mode of operation, **are not dangerous** to the health of the operators.



WARNING!

Excessive vibration can only be caused by a mechanical fault that must be immediately reported and eliminated, in order not to compromise the safety of the line and of the operators.

Residual risks

The machine has been designed to assure the essential safety requirements for the operator.



Safety has been integrated into the design and construction of the machine as far as possible; however, risks from which operators must be protected remain.

For each residual risk, a description of the risk and of the zone or part of the machine subject to the residual risk is provided (unless it is a risk valid for the entire machine). Procedural information on how to avoid the risk and on the correct use of the personal protection devices provided and required by the Manufacturer is also provided.

Risk	Description and procedural information
Risk of crushing	The risk of crushing lower limbs under the load during its descent remains.
Risk of load falling	The risk of load falling and crushing during handling operations remains.

Safety pictograms applied to the machine

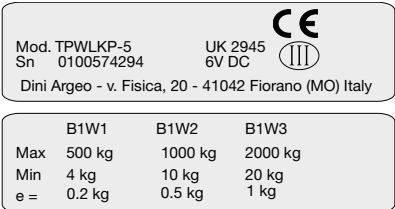
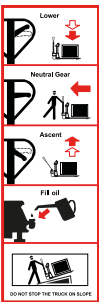
Stickers and safety plates are applied to the machine, as shown in the following table. Refer to the image for positioning.

Pos.	Pictogram	Description																
1	 <p>Mod. TPWLKP-5 UK 2945 Sn 0100574294 6V DC</p> <p>Dini Argeo - v. Fisica, 20 - 41042 Fiorano (MO) Italy</p> <table border="1"> <tr> <td></td> <td>B1W1</td> <td>B1W2</td> <td>B1W3</td> </tr> <tr> <td>Max</td> <td>500 kg</td> <td>1000 kg</td> <td>2000 kg</td> </tr> <tr> <td>Min</td> <td>4 kg</td> <td>10 kg</td> <td>20 kg</td> </tr> <tr> <td>e =</td> <td>0.2 kg</td> <td>0.5 kg</td> <td>1 kg</td> </tr> </table>		B1W1	B1W2	B1W3	Max	500 kg	1000 kg	2000 kg	Min	4 kg	10 kg	20 kg	e =	0.2 kg	0.5 kg	1 kg	CE IDENTIFICATION PLATES
	B1W1	B1W2	B1W3															
Max	500 kg	1000 kg	2000 kg															
Min	4 kg	10 kg	20 kg															
e =	0.2 kg	0.5 kg	1 kg															
2		<p>WARNING PLATE:</p> <ul style="list-style-type: none"> • load lowering; • load transport; • load lifting; • oil filling; • do not use on slopes. 																
3		MANUFACTURER DATA STICKER																
4		BATTERY INDICATIONS STICKER																

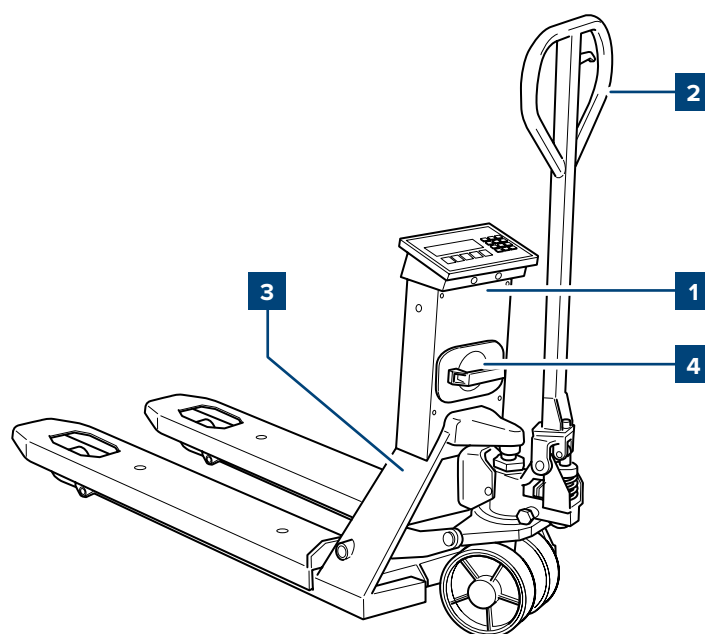

DESCRIPTION

Intended use (correct)

The machine in question is intended for **industrial use** for:

- the **weighing and handling of objects placed on Europallet**.

Max Europallet capacity permitted:

MODEL	CAPACITY
TPWN	2000 kg
TPWP	2500 kg
TPWLK	2000 kg
TPWA	2000 kg
TPWI	2000 kg
TPWLKI	2000 kg

The machine has been designed to:

- meet the specific needs mentioned in the sales contract;
- be used according to the instructions and limits of use provided in this manual.

The machine has been designed and built to operate safely if:

- it is used within the limits stated on the contract and in this manual;
- the user manual procedures are followed;
- scheduled maintenance is carried out in the times and in the ways indicated;
- unscheduled maintenance is promptly carried out if required.

Reasonably foreseeable misuse

The **reasonably foreseeable misuses**, which are to be intended as strictly forbidden, are listed below:

- transporting people;
- transporting unstable or incorrectly stacked loads or fluids;
- using the machine as a support point;
- using the machine on a slope;
- using the machine in poorly lit areas;
- using the machine in order to obtain production values above the required limits;
- using the machine differently than described in paragraph “**Intended use (correct)**”.

Any other use of the machine with respect to that required must be previously authorised in writing by the Manufacturer. In the absence of said written authorisation, the use is to be considered “**improper use**”; therefore the Manufacturer declines any responsibility in regards to damage caused to property or people and deems any type of warranty on the machine expired.



IMPORTANT!

An improper use of the machine relieves the Manufacturer from any responsibility.

Obligations and prohibitions

Operator obligations

The operator **must**:

- Perform maintenance operations always with the machine switched off. Not lubricate moving parts.
- When the machine is running, not operate nearby while wearing chains, bracelets, ties or other clothing that may get caught in the mechanisms.
- Operators with long hair must tie them up in order to prevent them from getting entangled.
- During operation, pay the utmost attention that no person is able to directly access moving parts.
- Use the protective devices made available by the employer in an appropriate manner.
- Immediately report any deficiencies of the safety devices to the employer, the manager or the person in charge.

Operator prohibitions

Specifically, operators **must not**:

- use the machine improperly, i.e. for uses other than those indicated in the paragraph “**Intended use (correct)**”;
- remove or modify safety or warning devices without authorisation;
- carry out operations or manoeuvres that are not within their competence or that may compromise their own safety or that of other workers on their own initiative;
- wear bracelets, rings or chains that can dangle and be dragged by moving parts, creating a hazard for the operator;
- replace or modify the speed of the components of the machine without being authorised by a manager;
- use the machine if it has not been installed according to the regulations in force;
- use the machine as a support point even if it is not running (under risk of falling and/or the risk of damaging the machine itself);
- use the machine outside the environmental conditions permitted (consult the paragraph “**Environmental conditions permitted**”).



WARNING!

DINI ARGEO is not liable for damage to things or people if it is ascertained that the machine has been used in a non permitted environment.

Technical data

TPWNAA

Material	PAINTED STEEL
Fork dimensions	1150 x 550 x 87 mm *
Weight	110 kg
Wheels	GUIDE WHEELS AND DOUBLE LOADING WHEELS IN POLYURETHANE *
Max capacity	2000 kg
IP Degree	-
Power supply	BATTERY, 4 "AA" TYPE
Printer	-
Keyboard	5 KEYS
Operating life	40 hrs

* Different sizes and materials are available at the specific request of the purchaser.

TPWNBT

Material	PAINTED STEEL
Fork dimensions	1150 x 550 x 87 mm *
Weight	110 kg
Wheels	GUIDE WHEELS AND DOUBLE LOADING WHEELS IN POLYURETHANE *
Max capacity	2000 kg
IP Degree	-
Power supply	BATTERY
Printer	-
Keyboard	5 KEYS
Operating life	80 hrs

* Different sizes and materials are available at the specific request of the purchaser.

TPWLK

Material	PAINTED STEEL
Fork dimensions	1150 x 550 x 85 mm *
Weight	125 kg
Wheels	GUIDE WHEELS AND DOUBLE LOADING WHEELS IN POLYURETHANE *
Max capacity	2000 kg
IP Degree	65 (ONLY VERSIONS WITHOUT PRINTER)
Power supply	WITH REMOVABLE BATTERY
Printer	OPTIONAL
Keyboard	17 KEYS
Operating life	80 hrs

* Different sizes and materials are available at the specific request of the purchaser.

TPWA

Material	PAINTED STEEL
Fork dimensions	1150 x 550 x 85 mm *
Weight	125 kg
Wheels	GUIDE WHEELS AND DOUBLE LOADING WHEELS IN POLYURETHANE *
Max capacity	2000 kg
IP Degree	-
Power supply	WITH REMOVABLE BATTERY
Printer	AS PER STANDARD
Keyboard	17 KEYS
Operating life	80 hrs

* Different sizes and materials are available at the specific request of the purchaser.

TPWET

Material	PAINTED STEEL
Fork dimensions	1150 x 550 x 85 mm *
Weight	125 kg
Wheels	GUIDE WHEELS AND DOUBLE LOADING WHEELS IN POLYURETHANE *
Max capacity	2000 kg
IP Degree	65 (ONLY VERSIONS WITHOUT PRINTER)
Power supply	WITH REMOVABLE BATTERY
Printer	OPTIONAL
Keyboard	TOUCHSCREEN
Operating life	10 hrs

* Different sizes and materials are available at the specific request of the purchaser.



WARNING!

For the functions of the models with touchscreen keypad, refer to the specific manual of the weight indicator software.

TPWP

Material	PAINTED STEEL
Fork dimensions	1150 x 550 x 85 mm *
Weight	125 kg
Wheels	GUIDE WHEELS AND DOUBLE LOADING WHEELS IN POLYURETHANE *
Max capacity	2500 kg
IP Degree	65 (ONLY VERSIONS WITHOUT PRINTER)
Power supply	WITH REMOVABLE BATTERY
Printer	OPTIONAL
Keyboard	17 KEYS
Operating life	80 hrs

* Different sizes and materials are available at the specific request of the purchaser.

TPWLKW

Material	PAINTED STEEL
Fork dimensions	1240 x 680 x 85 mm *
Weight	134 kg
Wheels	GUIDE WHEELS AND DOUBLE LOADING WHEELS IN POLYURETHANE *
Max capacity	2000 kg
IP Degree	65 (ONLY VERSIONS WITHOUT PRINTER)
Power supply	WITH REMOVABLE BATTERY
Printer	OPTIONAL
Keyboard	17 KEYS
Operating life	80 hrs

* Different sizes and materials are available at the specific request of the purchaser.

TPWLKI

Material	STAINLESS STEEL
Fork dimensions	1180 x 550 x 80 mm *
Weight	135 kg
Wheels	GUIDE WHEELS AND DOUBLE LOADING WHEELS IN NYLON *
Max capacity	2000 kg
IP Degree	68 (ONLY VERSIONS WITHOUT PRINTER)
Power supply	WITH NON REMOVABLE INTERNAL BATTERY
Printer	OPTIONAL (IP65)
Keyboard	17 KEYS
Operating life	80 hrs

* Different sizes and materials are available at the specific request of the purchaser.

TPWI

Material	STAINLESS STEEL
Fork dimensions	1180 x 550 x 80 mm *
Weight	135 kg
Wheels	GUIDE WHEELS AND DOUBLE LOADING WHEELS IN NYLON * [VULKOLAN FOR THE TPWID VERSION]
Max capacity	2000 kg
IP Degree	68 (ONLY VERSIONS WITHOUT PRINTER)
Power supply	WITH NON REMOVABLE INTERNAL BATTERY
Printer	OPTIONAL (IP65)
Keyboard	17 KEYS
Operating life	80 hrs

* Different sizes and materials are available at the specific request of the purchaser.

Environmental conditions permitted

The environment in which the machine must be used is an internal environment protected from weathering such as rain (except IP versions), hail, snow, fog, suspended dust, combustible dust and must not be classified and protected from saline solutions, aggressive agents such as acids or corrosive vapours and excessive heat sources. The ground must have an adequate maximum permitted load (cement, asphalt) and an even surface.

The machine has been designed and built to operate safely in the following environmental conditions:

Room temperature	-10°C ~ + 40°C
Maximum relative humidity	85 % non-condensing
Room lighting	min. 50 lux - non-glare light
Support surface	perfectly flat concrete industrial floor



WARNING!

Environmental conditions other than those specified may cause serious damage to the machine and void the warranty.



IMPORTANT!

The work surface must be sufficiently illuminated.

In the event of dark areas in the workplace, it will be the user's responsibility to provide suitable lighting devices.

Main components

The machine is made up of the following main components:

Pos.	Component
1	LOADING FORKS
2	LOAD CELLS
3	STEERING WHEELS
4	DOUBLE LOADING WHEELS
5	TILLER WITH MULTIFUNCTION LEVER
6	FIXED OR ADJUSTABLE MULTIFUNCTION WEIGHT INDICATOR
7	RECHARGEABLE BATTERY
8	BUILT-IN PRINTER

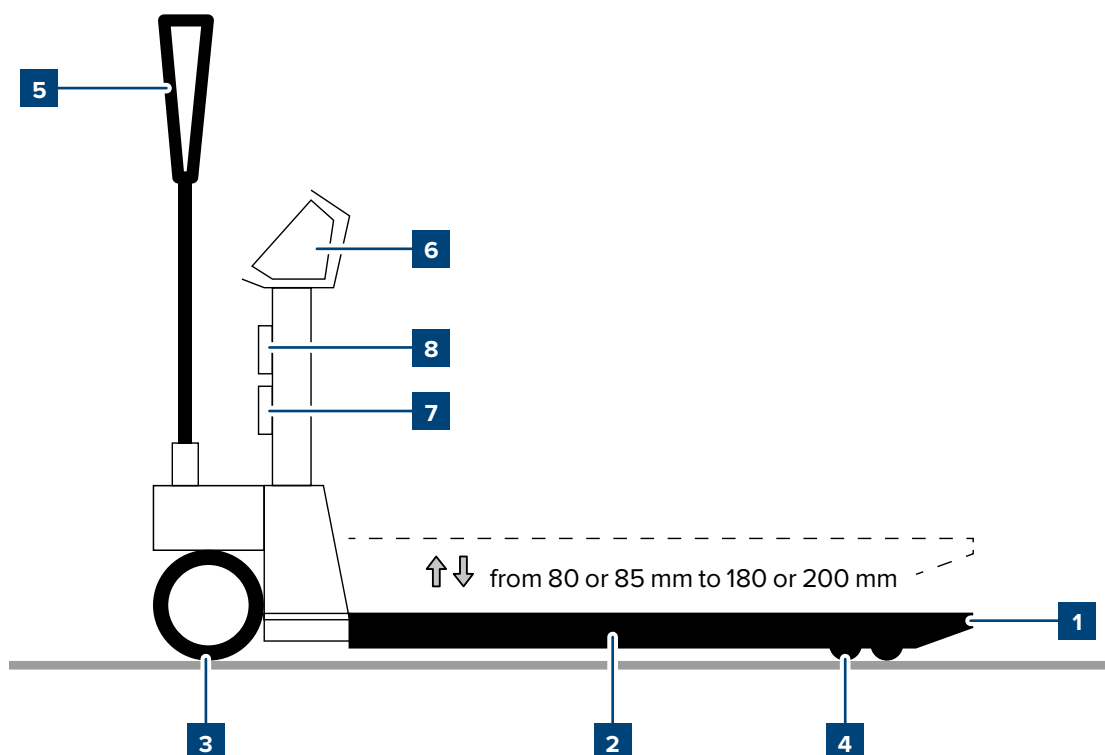

Rechargeable battery

Depending on the model purchased, the Pallet truck can be equipped with:

- battery drawer (AA type) (A),
- internal rechargeable battery (B),
- removable rechargeable battery (C).

The battery life depends on the model, if from 10 to 80 hrs.

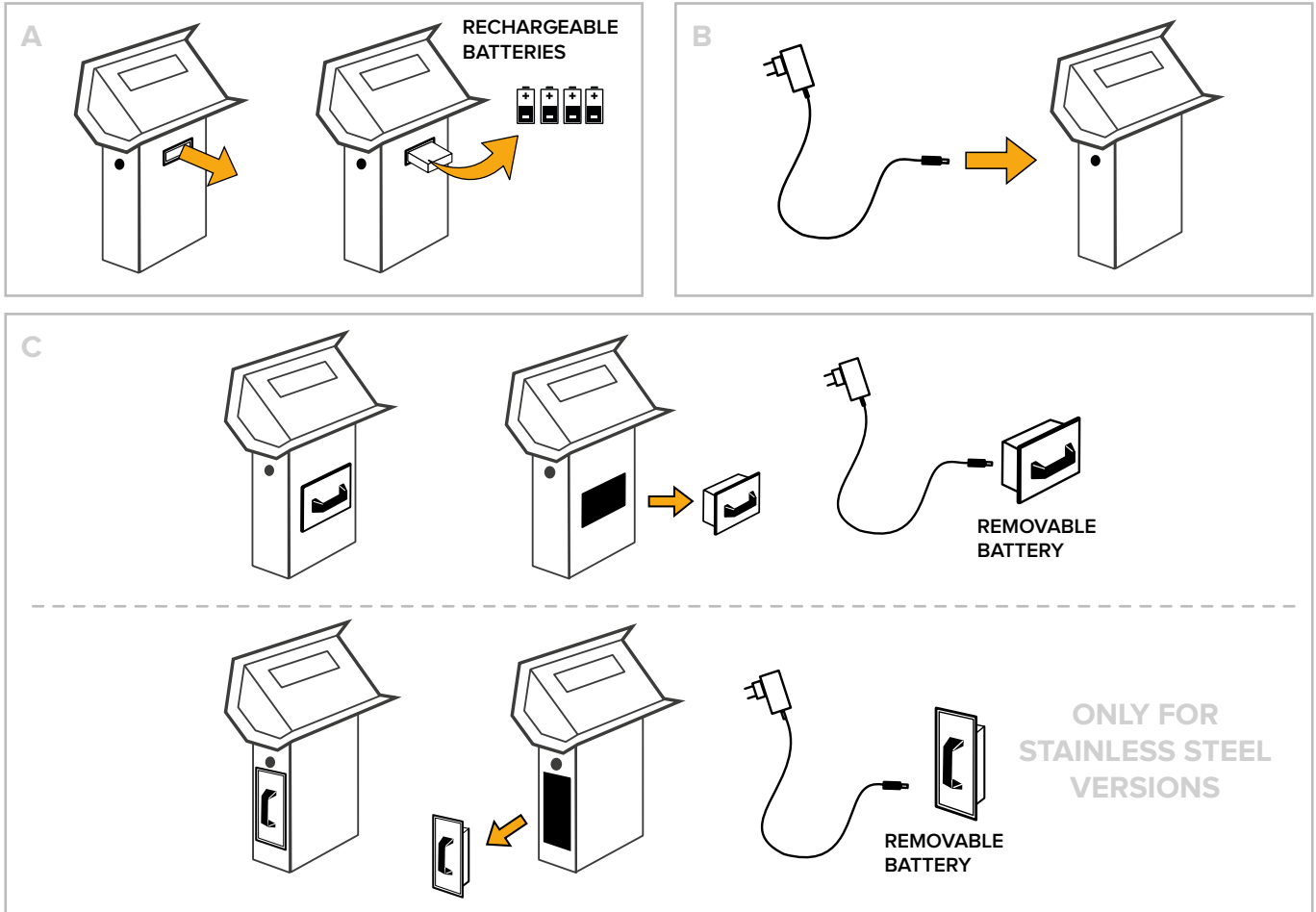

IMPORTANT!

Before turning the pallet truck on for the first time, fully charge the battery for 12 hours.



IMPORTANT!

Only use original batteries and battery chargers supplied.



IMPORTANT!

During normal use, never leave the battery partially or fully discharged. Fully recharge it at least once a week.



IMPORTANT!

In case of prolonged periods of disuse, we recommend removing the batteries (in pertaining models) and storing it in a dry place, away from changes in temperature.

Optional components

The machine can be equipped with the following optional components:

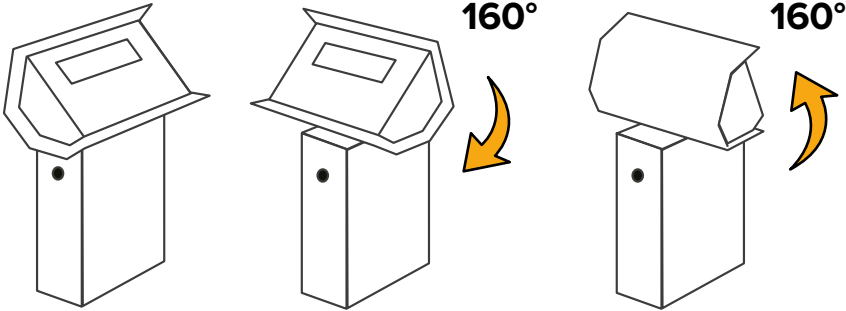
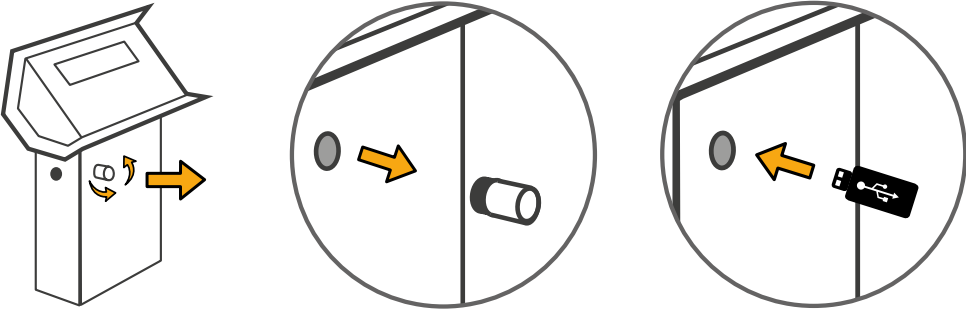
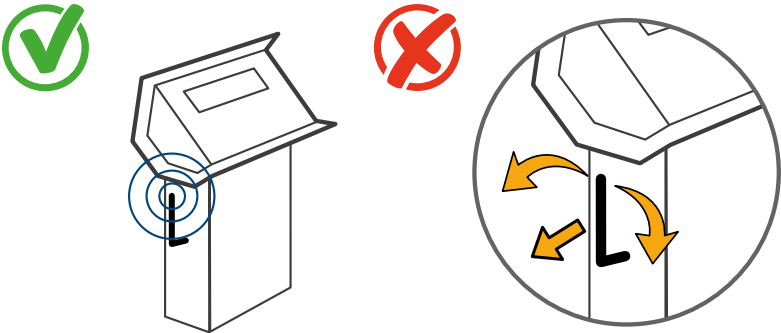
Component	Description and Image
<p>SWIVEL COLUMN (standard depending on model)</p>	<p>Ensures maximum display reading comfort.</p> 
<p>USB PORT (depending on model)</p>	<p>Enables to store all completed weighing operations on memory stick.</p> 
<p>ANTENNA (depending on model)</p>	<p>Fixed antenna for wireless data transmission.</p> 

BRAKE

Pedal parking brake unit installed on steering wheels.

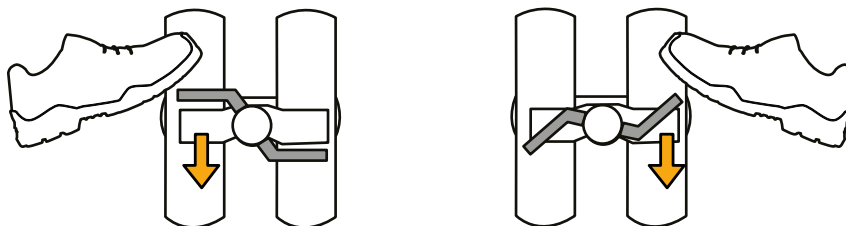

INTEGRATED THERMAL PRINTER

It allows to print the receipt or the label, which in turn can be customised.

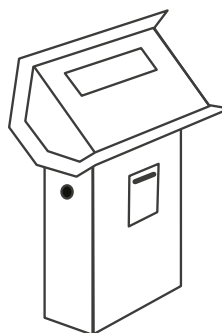

PACKAGING AND HANDLING

Packaging and handling warnings



WARNING!

DINI ARGEO is not liable for damage, to things or people, caused by accidents due to failure to follow the instructions provided in this manual.



WARNING!

Use lifting equipment with a capacity suitable for the weight to be lifted.



IMPORTANT!

Lifting and handling operations must only be carried out by specialised and trained personnel, who are qualified to carry out these activities.

Packaging

The pallet truck is transported disassembled and packaged inside a cardboard box with a strapped pallet. The TPWLKI and TPWLKW models on the other hand, are transported fully assembled on a pallet and strapped to it.

Upon receiving the packaged machine, the customer must verify that there is no damage caused by the mode of transport or by the personnel in charge of the specific operations.

If damage is detected, leave the packaging in question in the state found and immediately request the assessment of the damage by the competent shipping company, then communicate the damage found to the competent transport insurance and sales outlet by means of a damage certificate.

Packaging handling

The packaging must be moved by means of a forklift with a capacity suitable for the weight to be lifted (refer to the table below to check the weight of your model).

Weights with transport crate:

MODEL	WEIGHT
TPWN	124 kg
TPWLK	138 kg
TPWA	138 kg
TPWP	138 kg
TPWLKW	148 kg
TPWLKI	135 kg
TPWI	135 kg

For handling, proceed as follows:

1. Position the forklift forks under the packaging containing the machine, as shown in the figure.
2. Make sure the forks come out from the rear of the load, for a length sufficient to eliminate any risk of tipping.
3. Lift slowly, making sure that the centre of gravity of the section is positioned at the centre of the lifting forks.

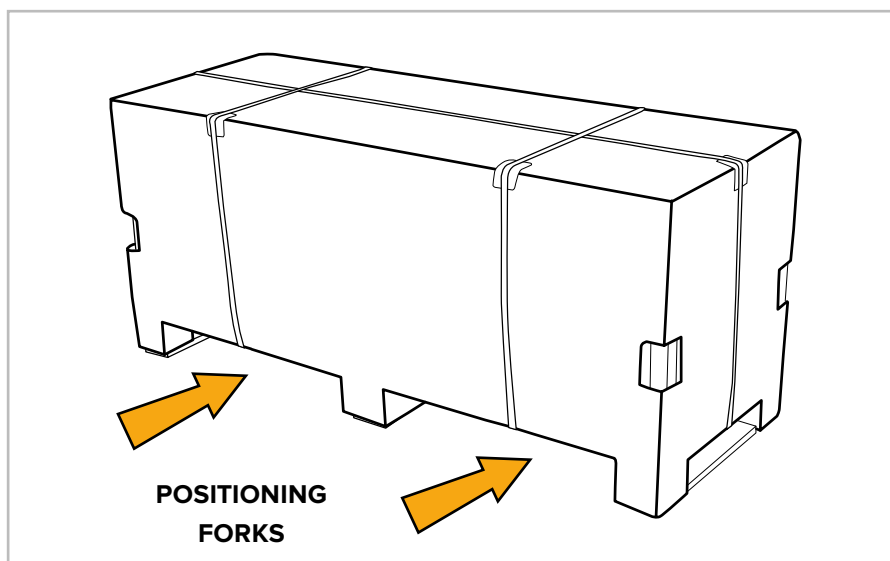

Packaging removal

To remove the packaging, proceed as follows:

1. Place the packaging containing the machine in the place of destination.
2. Remove the machine parts from the packaging and place them on a flat surface.
3. Proceed with assembly operations (refer to chapter “ASSEMBLY”).

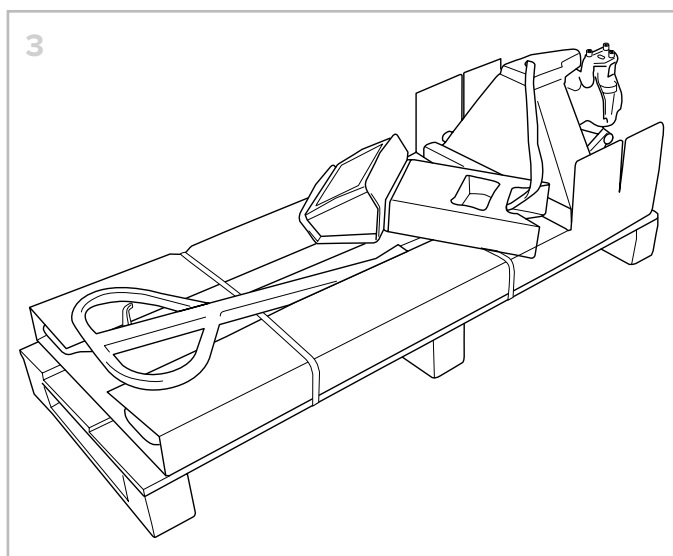
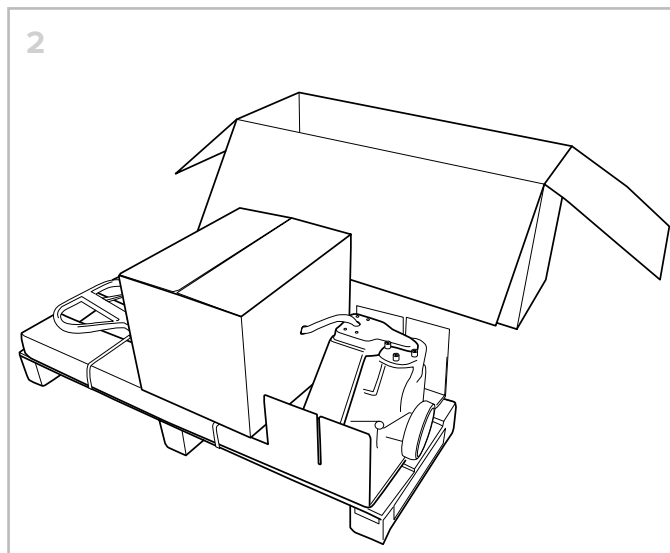
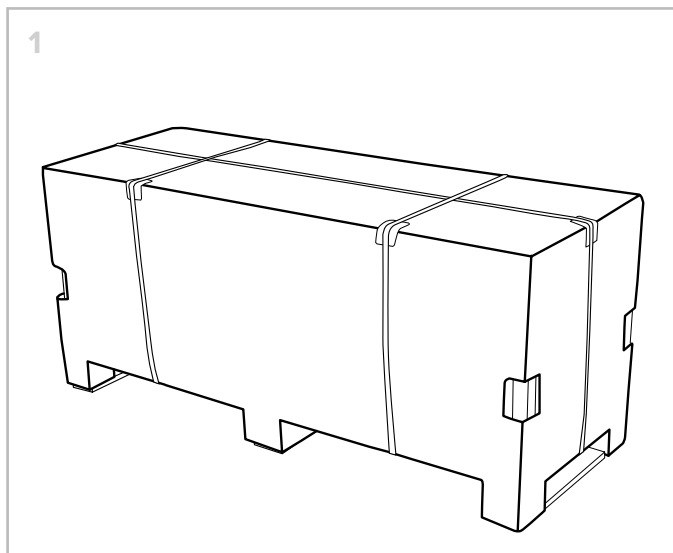

WARNING!

The TPWLKI and TPWLKW models on the other hand, are transported fully assembled on a pallet and strapped to it.

Packaging disposal

The packaging is an integral part of the supply and is not collected, therefore the purchaser is in charge of disposing of it.



IMPORTANT!

Dispose of the packaging in compliance with the regulations in force in the country of the user.

ASSEMBLY

Assembly warnings



WARNING!

DINI ARGEO is not liable for damage, to things or people, caused by accidents due to failure to follow the instructions provided in this manual.



IMPORTANT!

Assembly operations must only be carried out by specialised and trained personnel, who are qualified to carry out these activities.

Assembly procedure

The machine is delivered divided into 3 parts:

- tiller,
- column,
- carriage.

To **assemble the parts**, proceed as follows:

A. Place the column on the base of the carriage and fix it by using the 4 bolts supplied.

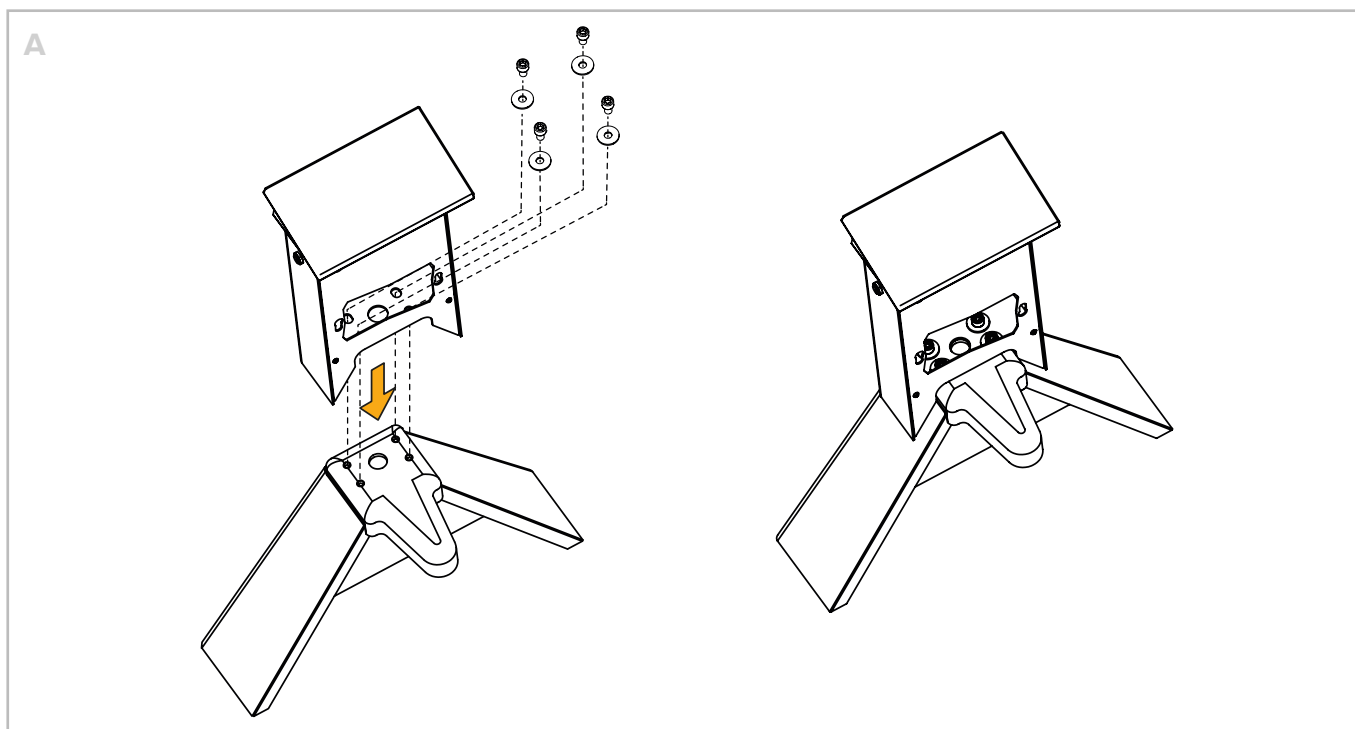

B. Assemble the tiller “version 1” or “version 2”, depending on the pallet truck model purchased.

VERSION 1

- B.1. Make sure the lifting lever is in “lowered” position.
- B.2. Position the tiller vertically above the carriage, making sure that the chain falls at the hole.
- B.3. Fix the tiller to the carriage by using the 3 bolts supplied.
- B.4. Hook the chain pin to the specific lever.

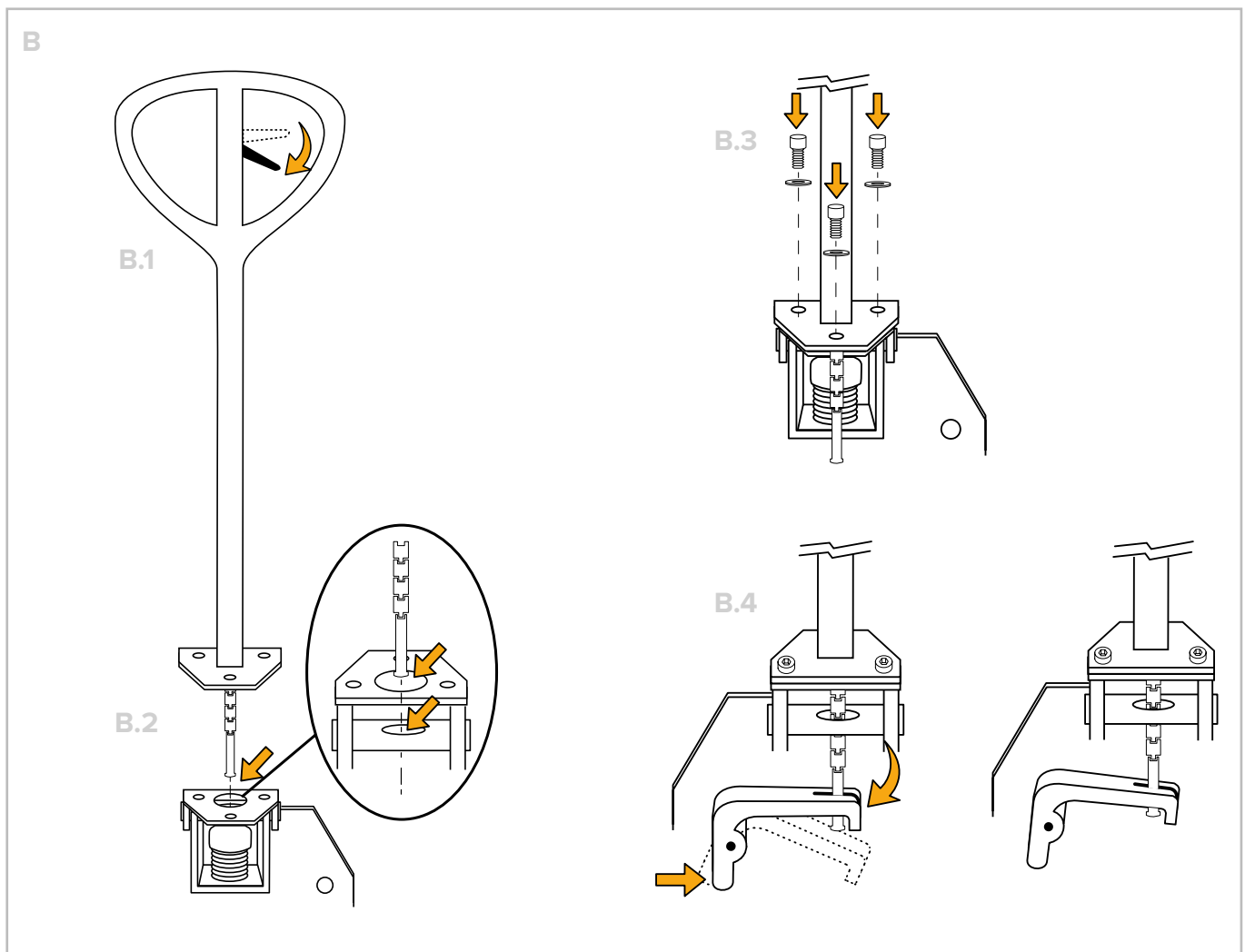

VERSION 2

- B.5. Position the tiller vertically above the carriage, making sure that the chain falls at the hole. Then insert the pin into the side hole.
- B.6. Insert the split pins to lock the pin.
- B.7. Hook the chain to the specific locking lever.
- B.8. Fully lower the tiller to compress the spring as much as possible, so as to leave enough space to remove the pin. Bring the tiller back to normal position.

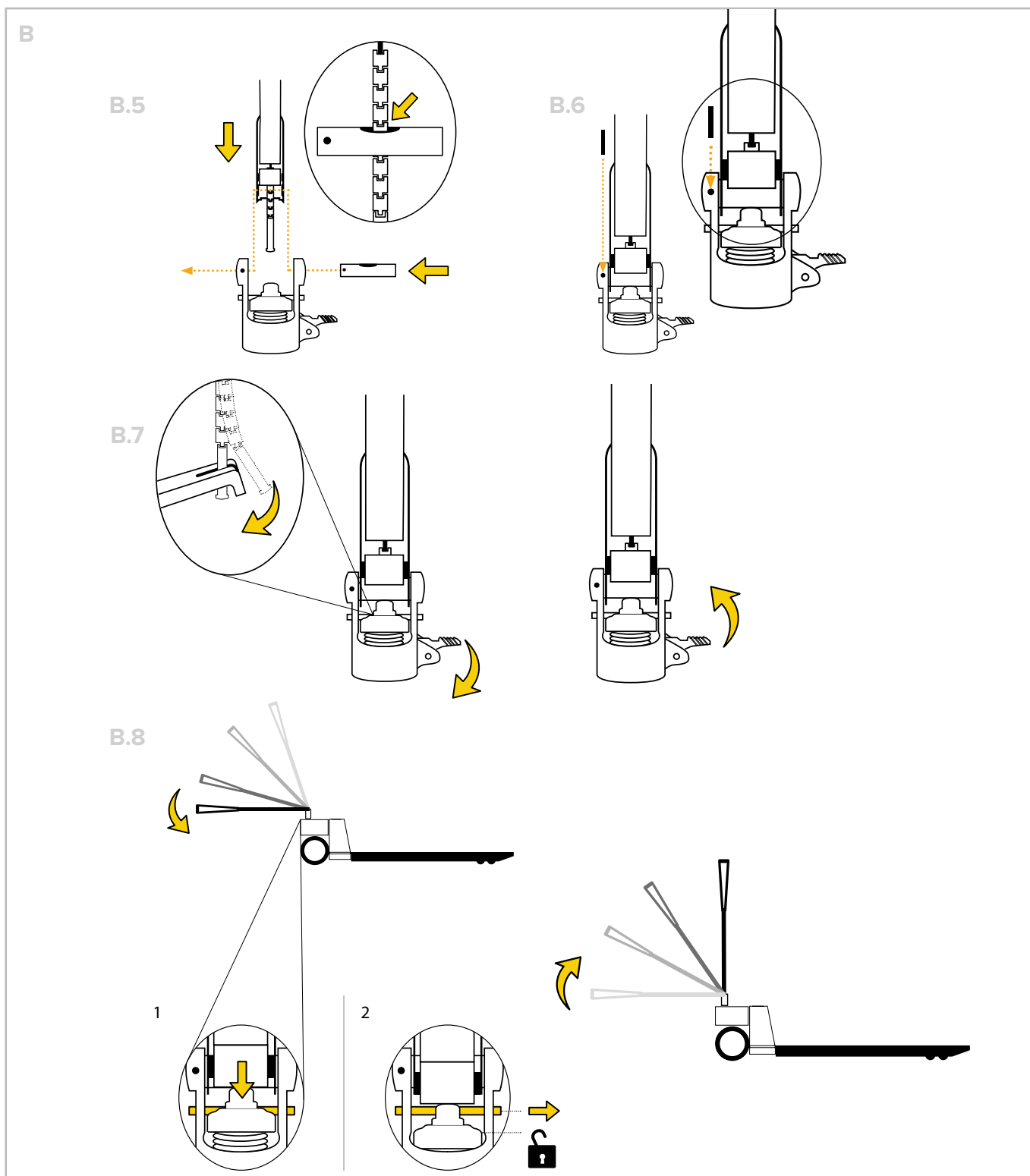

C. Install the battery in the specific compartment.

The battery can be connected to the machine by means of:

- with connection cable (C.1),
- snapping on (C.2).

When connecting the battery by using a connecting cable, after connecting the cable, place the battery in the specific compartment.

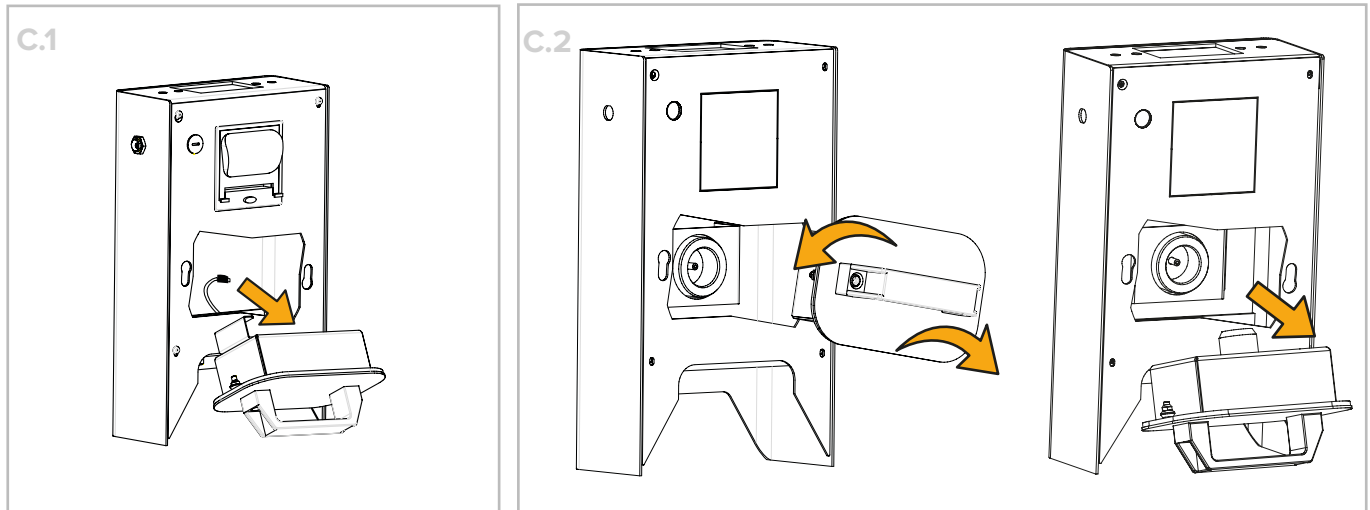

After carrying out the assembly operations described, it is possible to proceed with regular use of the machine.

Descent adjustment

The machine is already adjusted for correct operation. However, should it be required to perform **descent adjustment**, refer to the procedure described below:

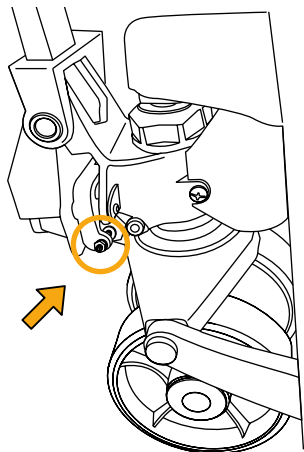

- A. Place the forks at the maximum height.
- B. Place the tiller control lever in POS. 1 (centre).
- C. Make sure the tiller is in the upright position.
- D. Unscrew the locknut, to unlock the adjustment screw.
- E. Slowly turn the adjustment screw clockwise until the forks start moving downwards.
- F. As soon as the forks start lowering, turn the adjustment screw one and a half turns anti-clockwise.
- G. Tighten the locknut, to lock the adjustment screw.
- H. Using the control lever, the downwards movement can be carried out from any tiller position.

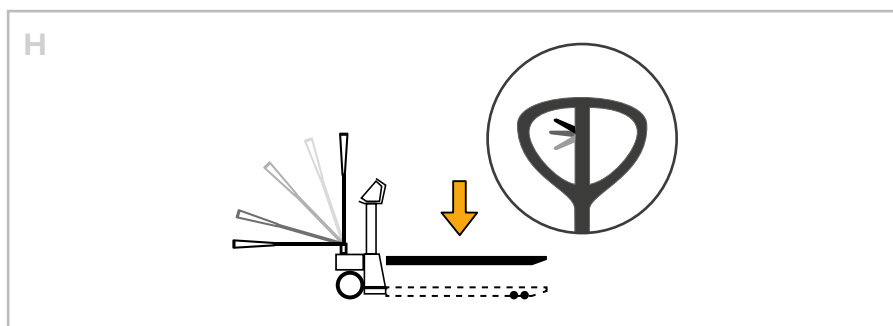
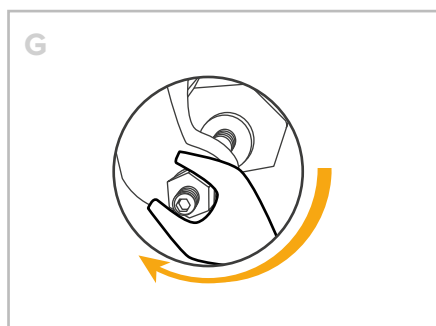
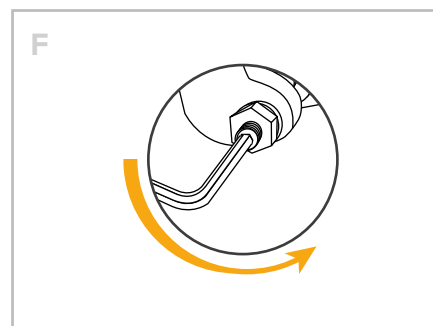
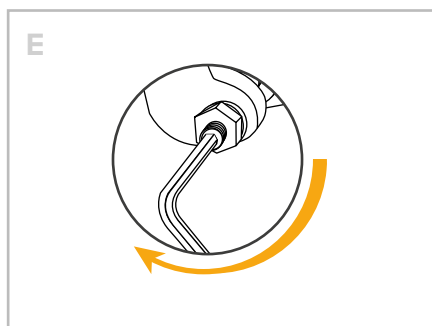
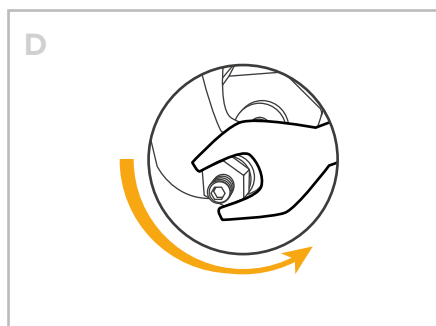
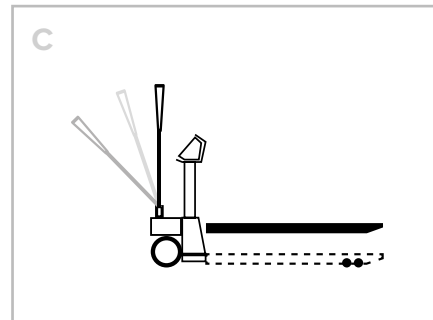
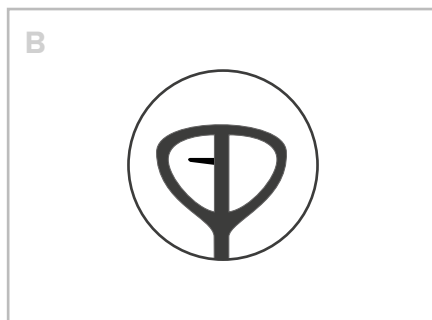
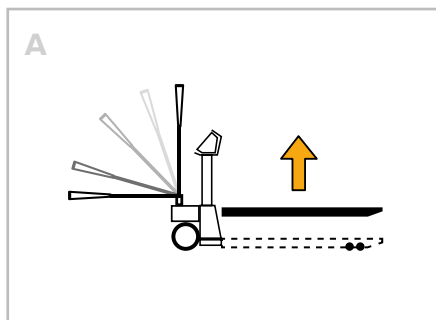

WARNING!

Make sure that with the tiller in its transport position, it is not possible to raise the forks. Otherwise:

- release the locknut,
- turn it half a turn clockwise,
- tighten the locknut back up again.

COMMANDS

Tiller commands

The raised load is moved forwards or backwards by the tiller, which controls the steering wheels. The tiller can be used in the following conditions:

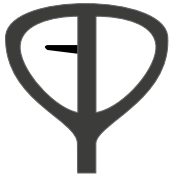
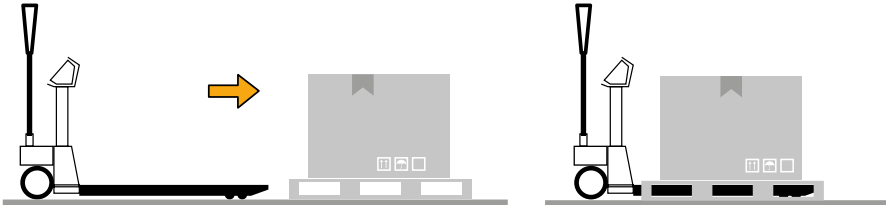
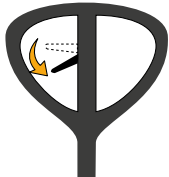
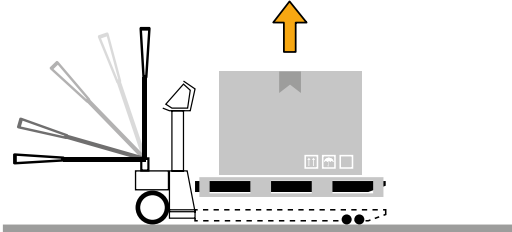
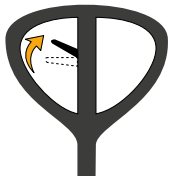
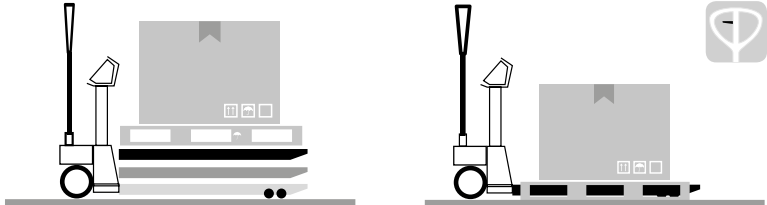
Condition	Image	Mode
AT THE CENTRE		<p>TRANSPORT</p> <p>The tiller is completely free for transport manoeuvres.</p> 
DOWN		<p>LIFTING</p> <p>Pull the tiller downwards to start up the lifting pump. A return spring places the tiller back in its upright position.</p> 
UP		<p>DESCENT</p> <p>Pull the lever upwards to lower the load. The descent speed is controlled by a special valve that starts up when the lever is firmly pulled to the end of its stroke.</p> 

 **IMPORTANT!**
 The pallet truck is equipped with a dual-function tiller: traction or manoeuvre and hydraulic lift. Raise or lower the truck only when stationary.

Display



Pos.	Icon	Description
1	→0←	Indicates that the scale is unloaded and at zero (gross).
2	~	Indicates that the weight is unstable.
3	🕒	Displays the time.
4	NET	The net weight is displayed. Note: there is a saved tare.
5 / 6	G B	The gross weight is displayed.
7	🔋	Indicates the battery level: 
8	Max= Min= e=	Metrics are displayed.
9	LT	A locked tare is active.
10	PT	A manual tare is active.
11	W1 W2 W3	Indicate the range of active weighing.
12	lb ... Pcs	Indicates the units of measurement: pounds (lb), tonnes (t), kilograms (kg), grams (g), number of pieces (pcs).
13	📏	The weight is displayed in high resolution.
14	*	This means a key is pressed. In some operating modes, it means that a specific function is active.
15	SP1... SP4	These indicate the active relay outputs (only with the optional board).

Keyboard types

KEYBOARD FOR DFWK06 INDICATOR



KEYBOARD FOR DFWLKI INDICATOR













KEYBOARD FOR 3590EGTXP INDICATOR



KEYBOARD FOR DFWL-1 INDICATOR



Button	Description
	<ul style="list-style-type: none"> Resets the weight on the scale. If pressed for a long time (2 sec), it is possible to set the brightness of the display.
	<ul style="list-style-type: none"> Performs tare on the scale. If pressed for a long time (2 sec), a preset tare can be entered.
	<ul style="list-style-type: none"> Recalls the specific function of the operating mode. If pressed for a long time (5 sec), it allows to change the operating mode.
 	<ul style="list-style-type: none"> Confirm key. Prints the receipt. If pressed for a long time (5 sec), the configuration menu can be accessed.
	<ul style="list-style-type: none"> If pressed for 2 sec it switches off the instrument. If pressed for 5 sec it displays the metrological information.
	<p>If pressed for a long time (2 sec) it displays the metrological information.</p>

	Performs the function (followed by pressing a number).
	If on, it indicates that the instrument is charging (for battery powered instruments).
	It allows to quickly set a numerical value.



WARNING!

For a clearer view and advanced functions related to the keys and operating modes, see the chapter “BASIC SCALE FUNCTIONS” and “ADVANCED SCALE FUNCTIONS”.





WARNING!

For the functions of the models with touchscreen keypad, refer to the specific manual of the weight indicator software.

USE

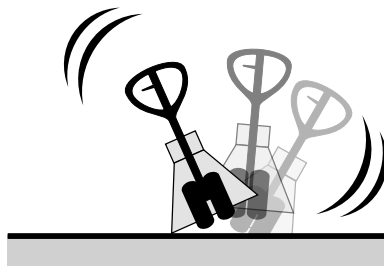
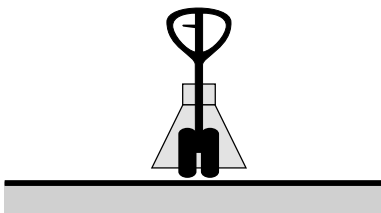
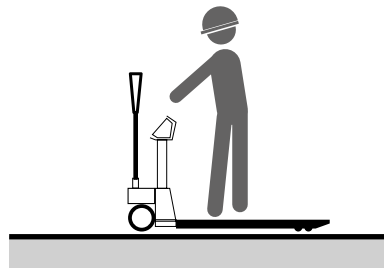
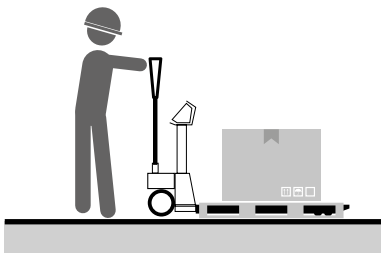
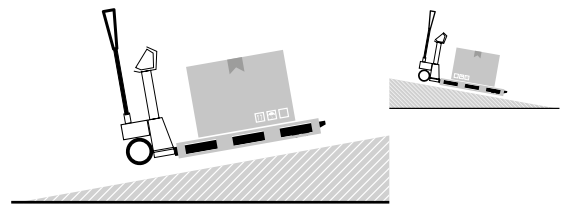
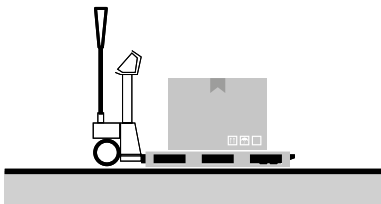
General warnings for correct use



 **WARNING!**
Pay attention during manoeuvring operations as the tiller has an upright return system.

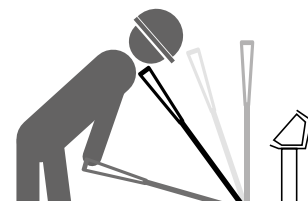

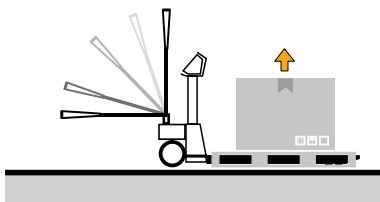
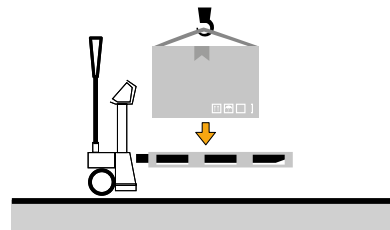
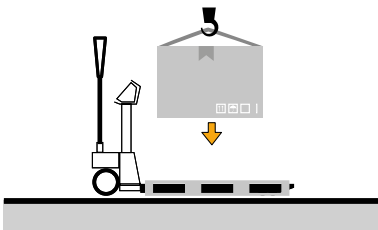
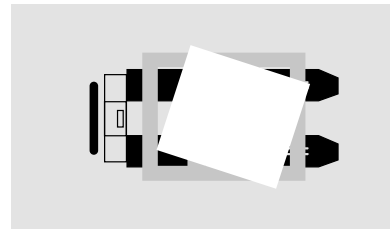
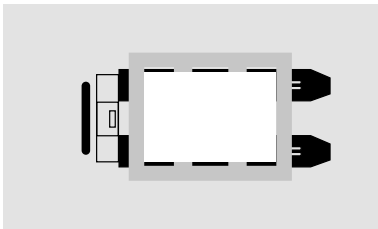
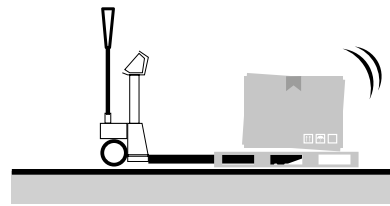
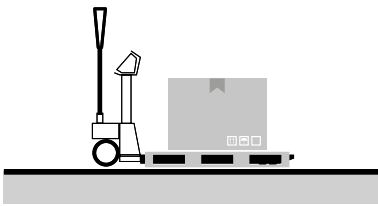

ONLY LIFT FROM STATIONARY*

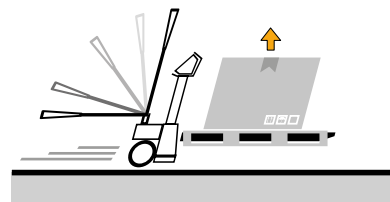

IMPORTANT!

The pallet truck is equipped with a dual-function tiller: traction or manoeuvre and hydraulic lift.

Note: raise or lower the truck **ONLY** when stationary.

Pallet truck conditions

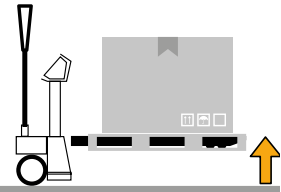
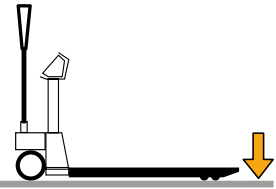
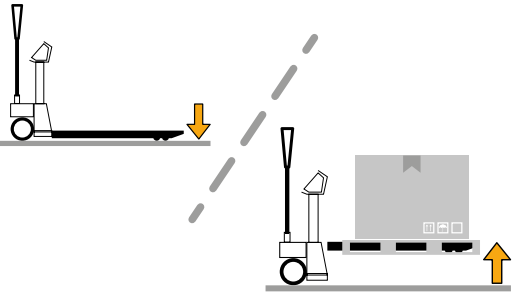
Condition	Description
 A line drawing of a pallet truck carrying a grey rectangular load. The forks are raised vertically. An orange arrow points upwards from the ground level to the bottom of the load, indicating the height of the load.	<p>The pallet truck is on, loaded and the forks are raised from the ground.</p>
 A line drawing of a pallet truck with a grey rectangular load. The forks are lowered to the ground level. An orange arrow points downwards from the top of the load to the ground level, indicating the height of the load.	<p>The pallet truck is on, loaded and the forks in lowered position.</p>
 A line drawing showing two pallet truck scenarios separated by a dashed diagonal line. On the left, a pallet truck with a lowered fork and an orange arrow pointing down is shown. On the right, a pallet truck with a raised fork, a load, and an orange arrow pointing up is shown.	<p>In this condition it does not matter whether the pallet truck is loading or unloading.</p>

Checks before use

Before using the pallet truck, check that:

- the forks do not show evident damage;
- the area of use is clear of any obstacles;
- no consumables losses are present in the area under the machine;
- the labels installed on the pallet truck are present and legible.



IMPORTANT!

If faults and/or anomalies are detected, report them to the personnel in charge.

Display switch-on

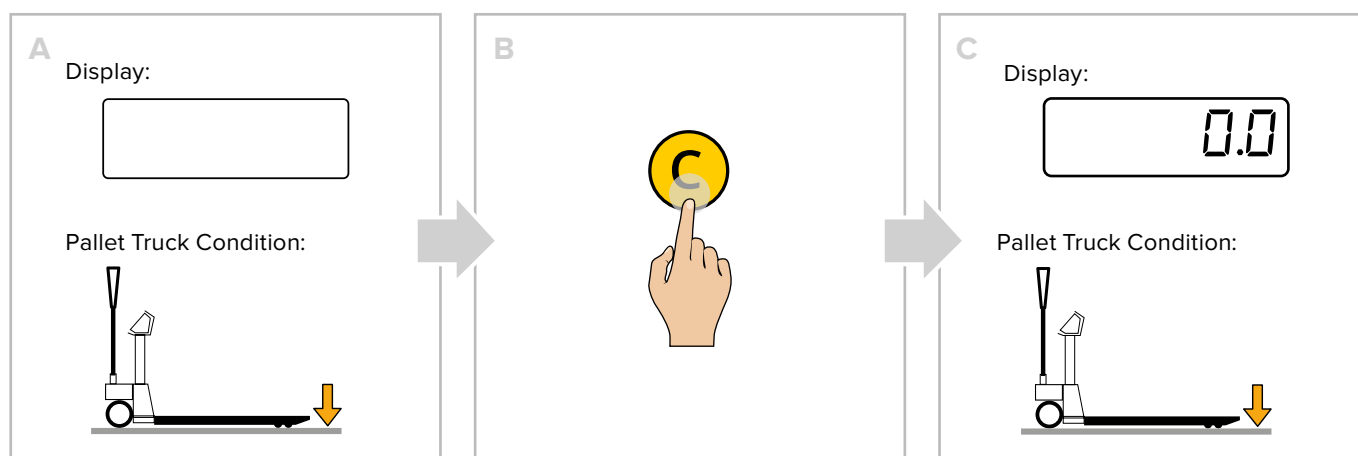

IMPORTANT!

Unload the Pallet Truck before turning it on



IMPORTANT!

If the instrument is approved, the power on must be carried out on the surface where the weighing will take place.

Pallet truck positioning

Position the pallet truck under the load to be weighed, as shown in the figure below.



IMPORTANT!

With approved scale, you can perform weighing on EUR pallet 800 x 1200 mm (UIC standards 435-2 and UIC 435-4 ref.).

Load lifting and weight reading

Lift the load, as shown in the figure below.

The value of the weighing can be read on the display.

Weighing accuracy is achieved when the pallet truck is fully stationary.

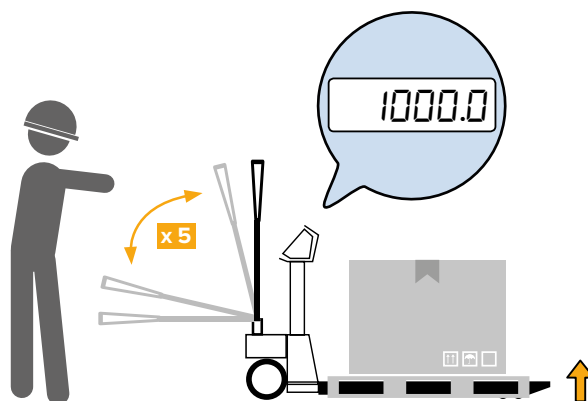

WARNING!

Make sure the pallet is fully raised from the ground.

How to replace the roll

To replace the integrated thermal printer roll (if present), proceed as follows:

- Open the door by pressing the centre button.
- Put the roll in, keeping the thermal surface facing outward.
- Close the door by pressing on both sides.
- Remove excess paper.

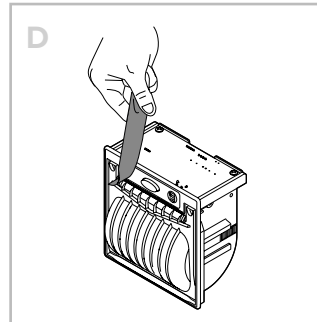
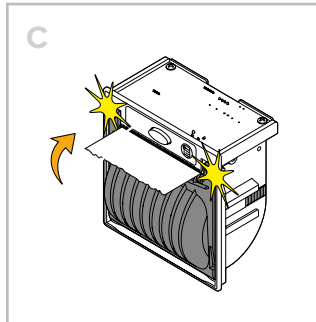
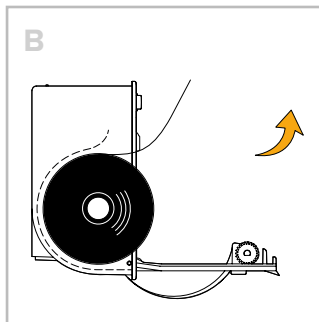
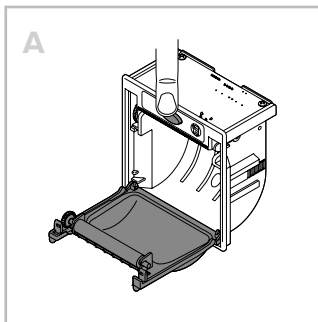

Customisable printouts

If the instrument is equipped with a printer, the ticket or label can be customised as shown in the following example.

 Customising printouts requires advanced configuration.

Example of ticket/label

MARIO ROSSI SRL VIA DELL'INDUSTRIA, 20 41042 - FIORANO (MO) - ITALY WWW.MARIOROSSI.IT	Header
WEIGHING NUM. 1	Progressive weighing number (for accumulation modes)
GROSS 15,000 kg TARE 3,000 kg NET 12,000 kg	Weight data
TICKET No. 54321	Progressive ticket number
05/08/2015 15:39:03	Date and time
	Bar code 39

Example of packing list

MARIO ROSSI SRL VIA DELL'INDUSTRIA, 20 41042 - FIORANO (MO) - ITALY WWW.MARIOROSSI.IT	
WEIGHING NUM. 00000001 NET 1,000 kg	
WEIGHING NUM. 00000002 NET 1,000 kg	
WEIGHING NUM: 00000003 NET 1,000 kg	
WEIGHING NUM. 00000004 NET 1,000 kg	
TOTAL WEIGHINGS 00000004 TOTAL NET 4,000 kg TICKET No. 12345 09/05/06 15:39:03	

BASIC SCALE FUNCTIONS

Start-up - On

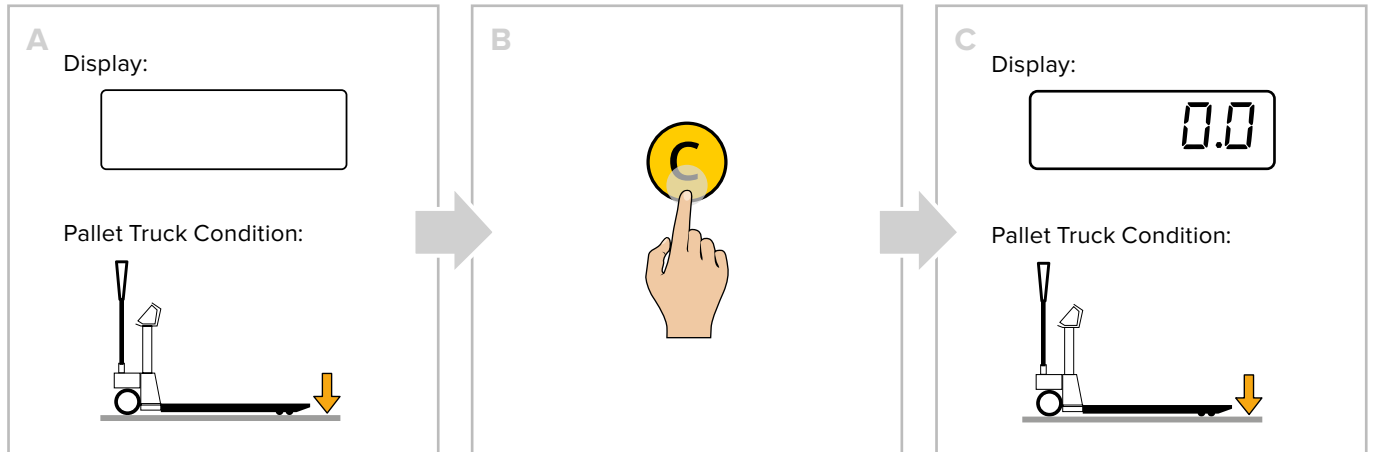

Shutdown - Off

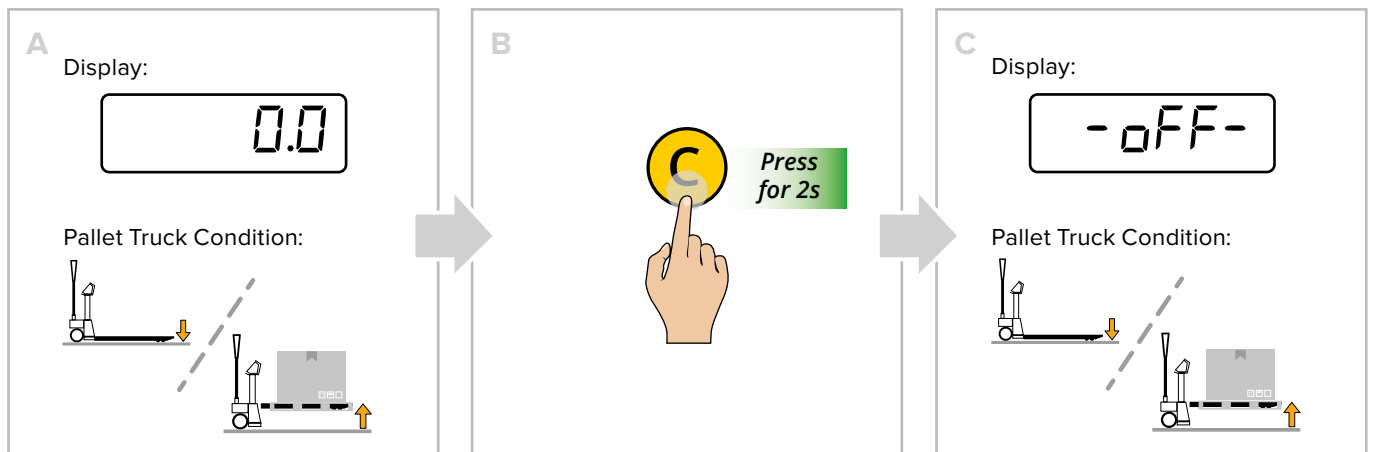

Zero

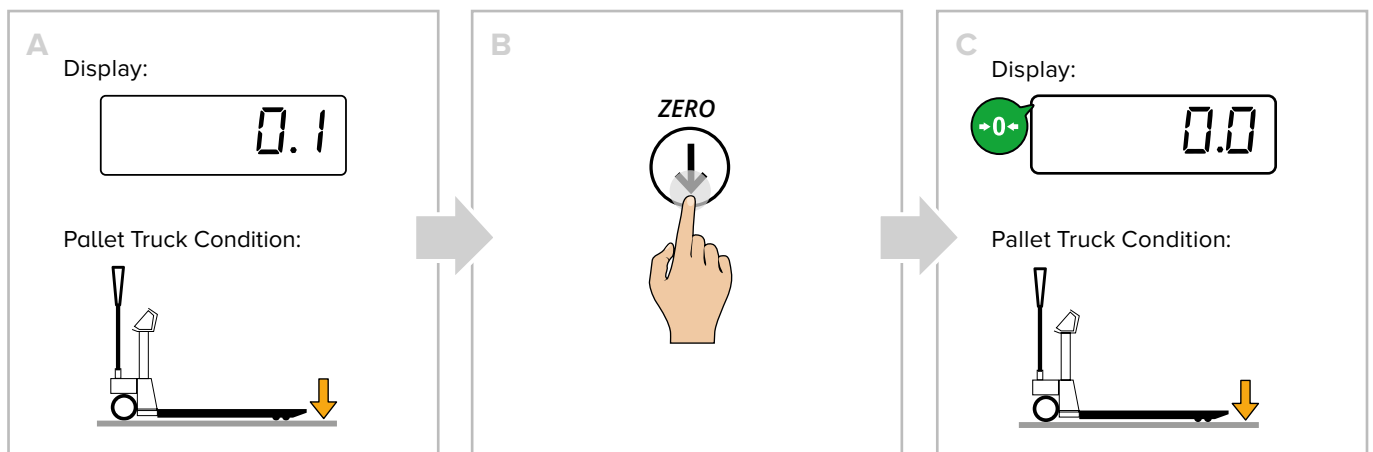

Display brightness adjustment

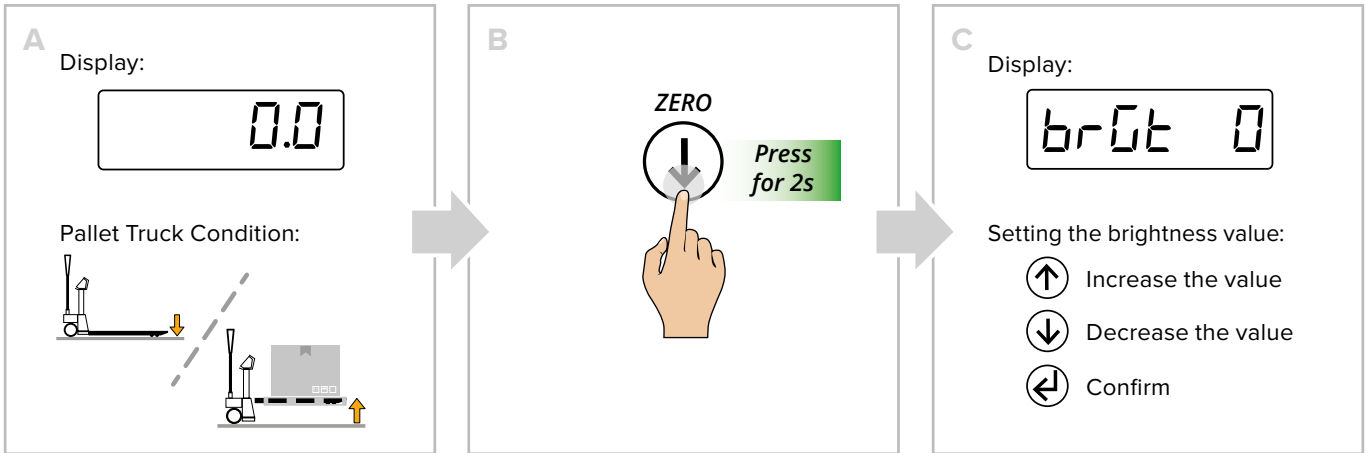

Automatic tare

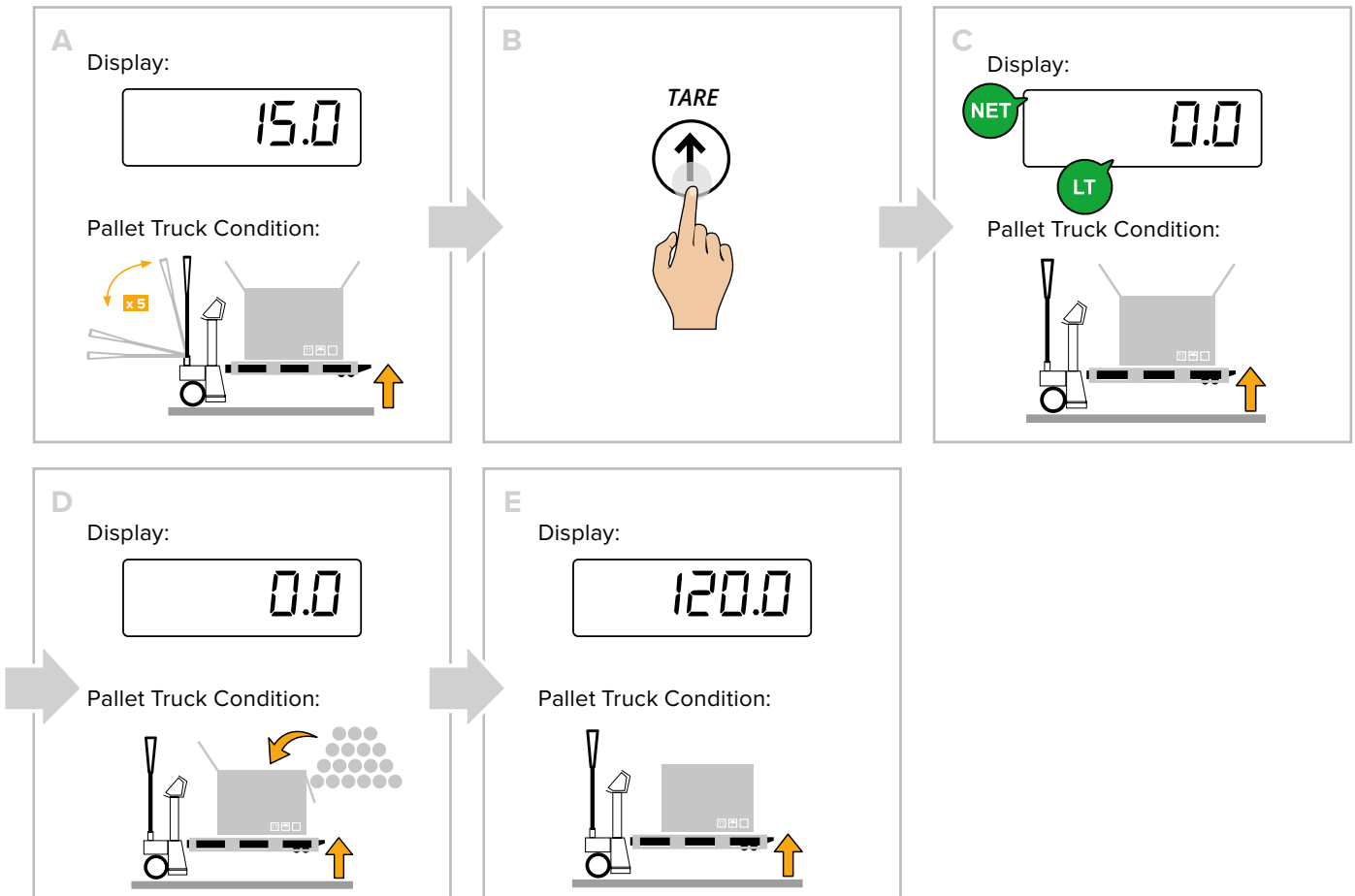
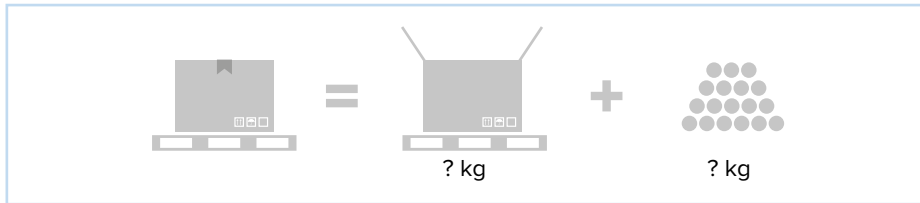

Tare deletion

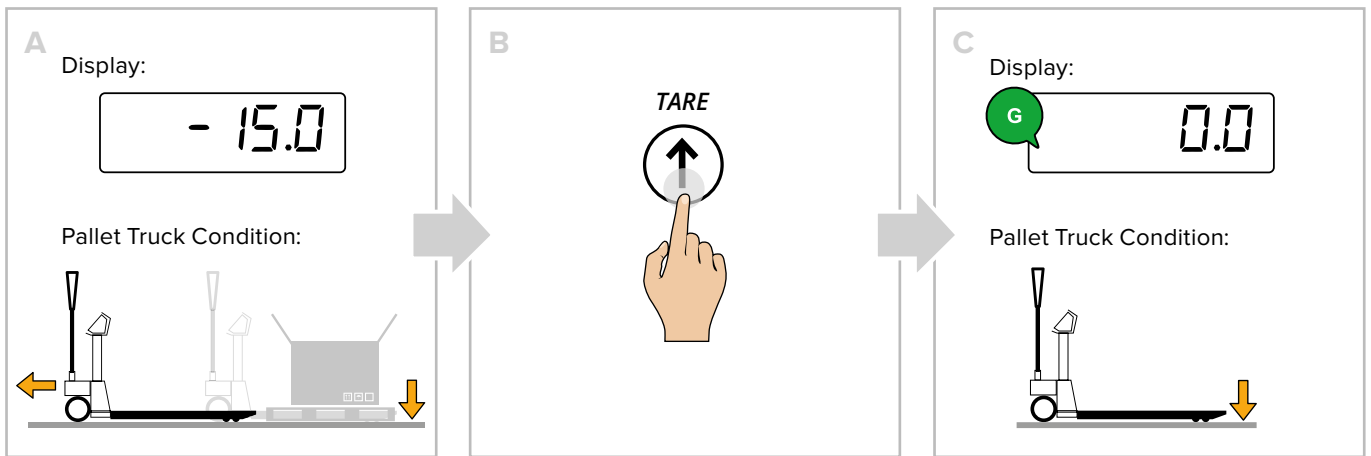

Set a known tare value (PT)

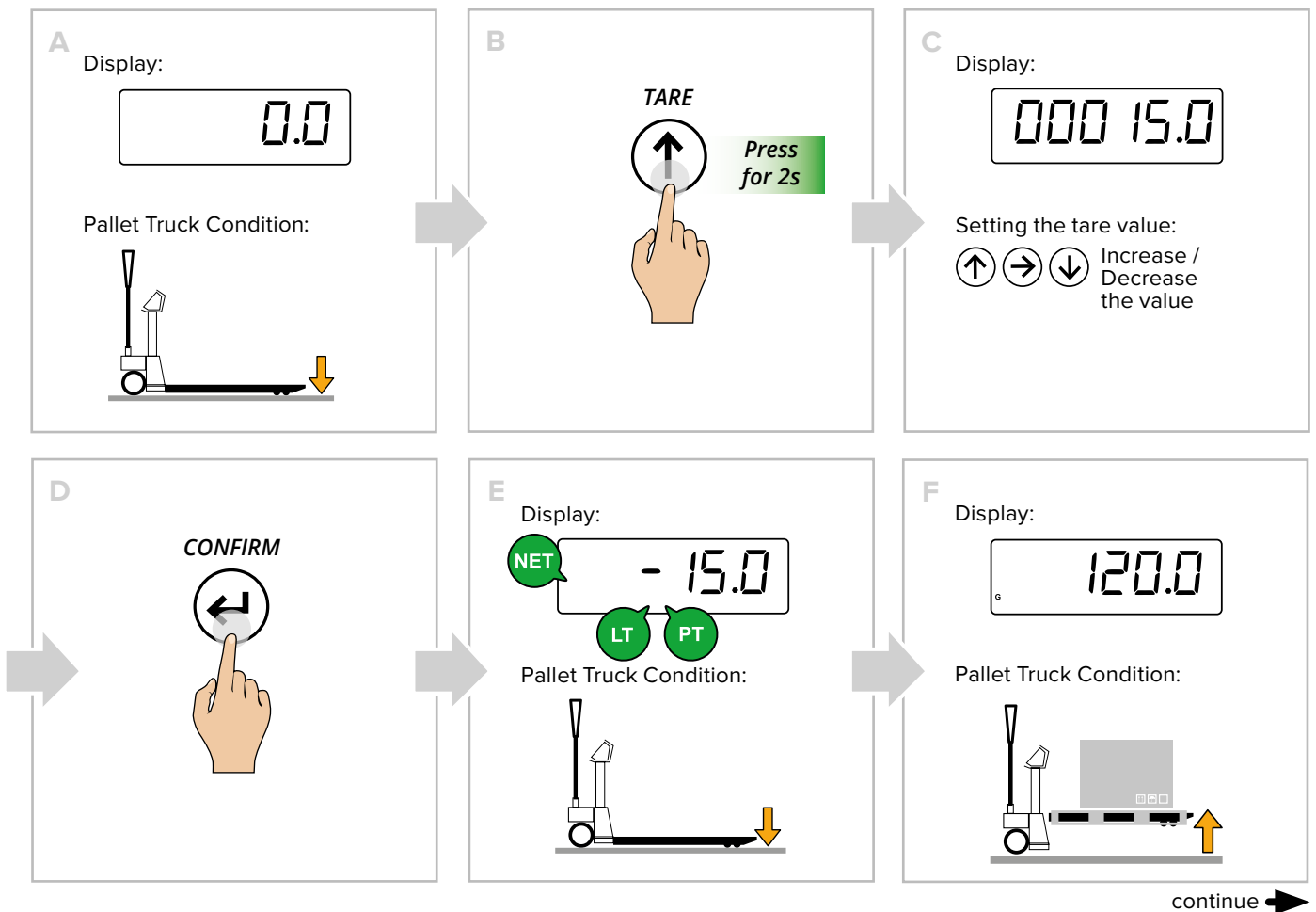

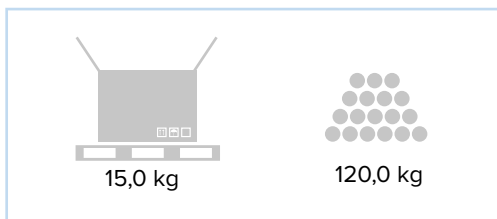

If the pallet truck has a number keypad, it is possible to enter the tare quickly:

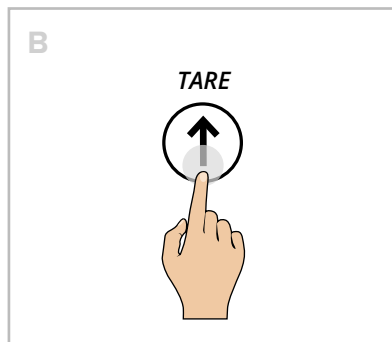
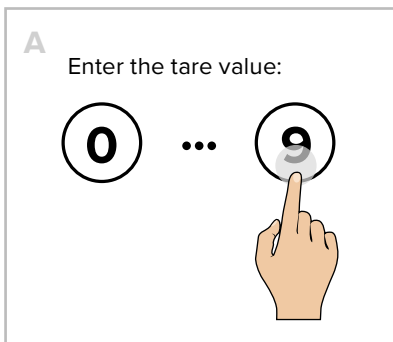

Print

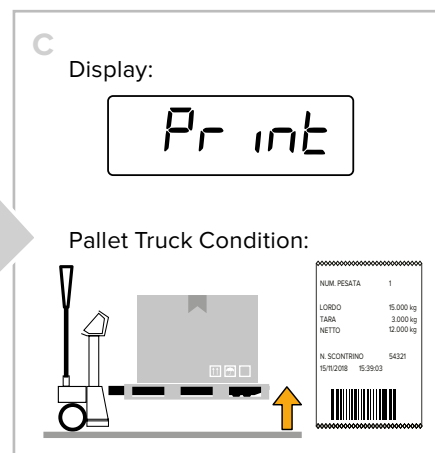
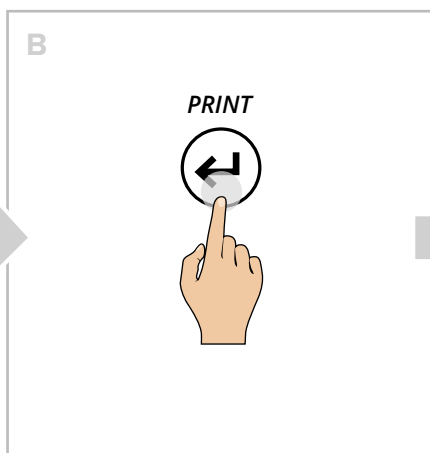
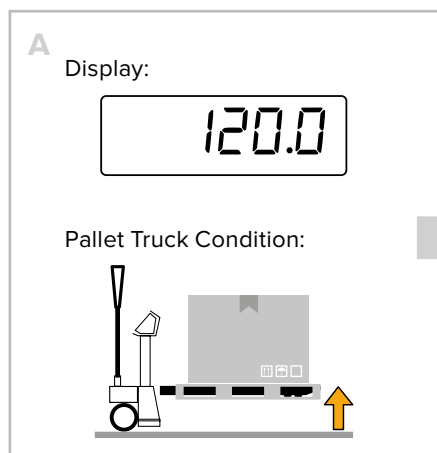

Metrics

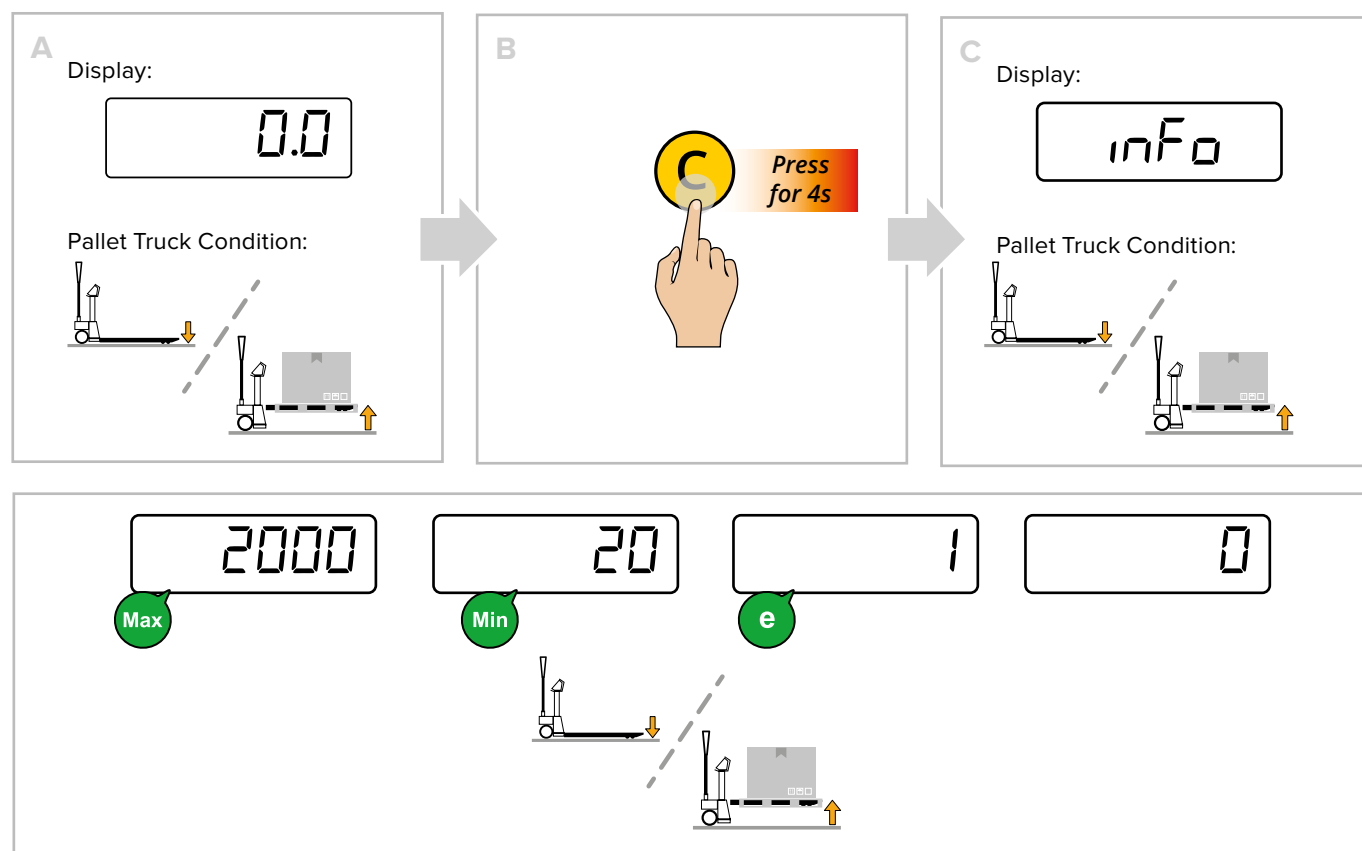

ADDITIONAL FUNCTIONS FOR MODELS WITH NUMBER KEYPAD

30-tare log

This memorises the most commonly used tares (up to 30), to simplify retrieval with quick selection.

Example

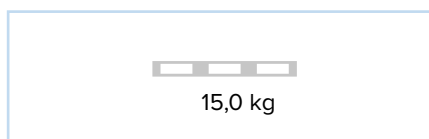

HOW TO STORE A TARE

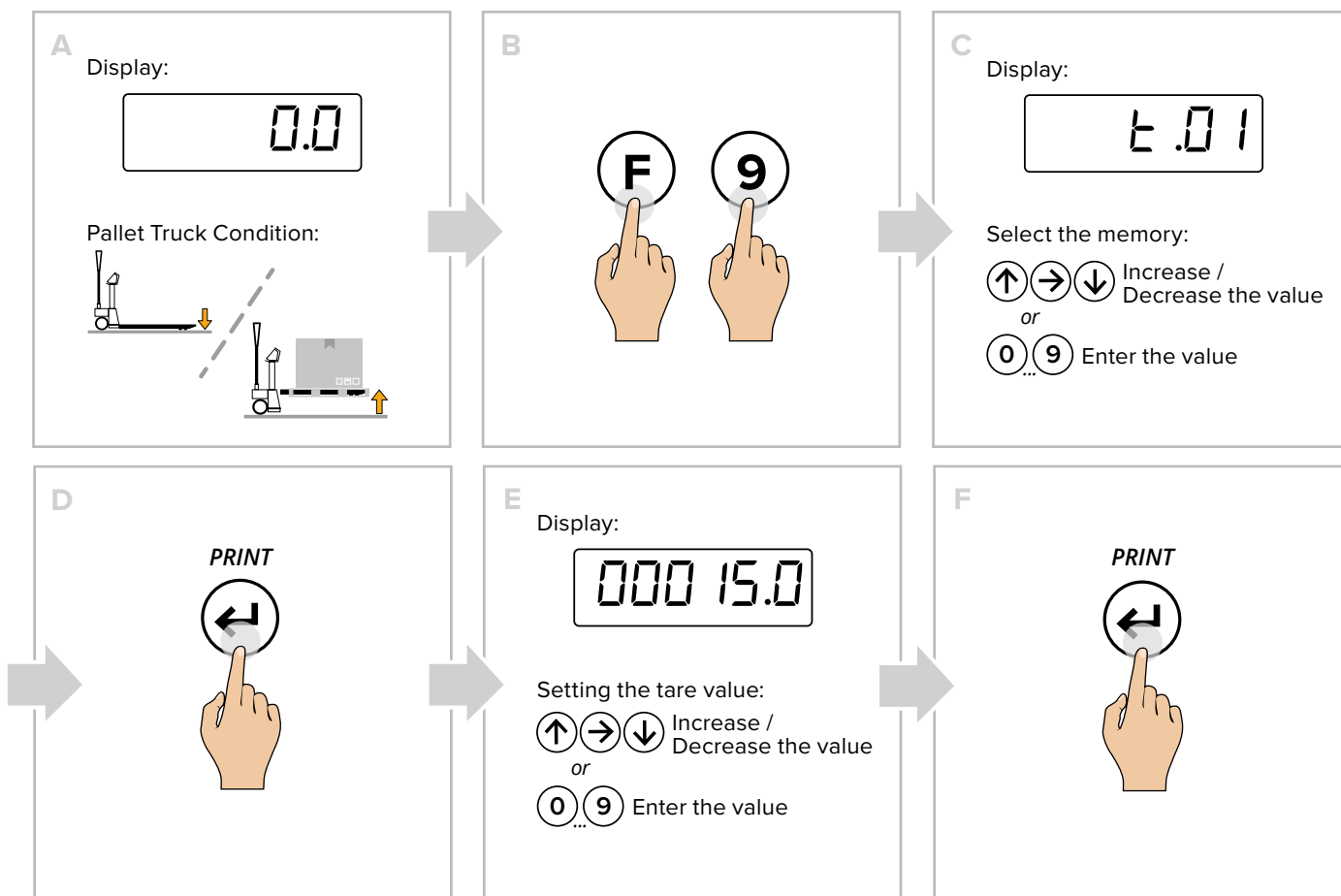

HOW TO RETRIEVE A STORED TARE

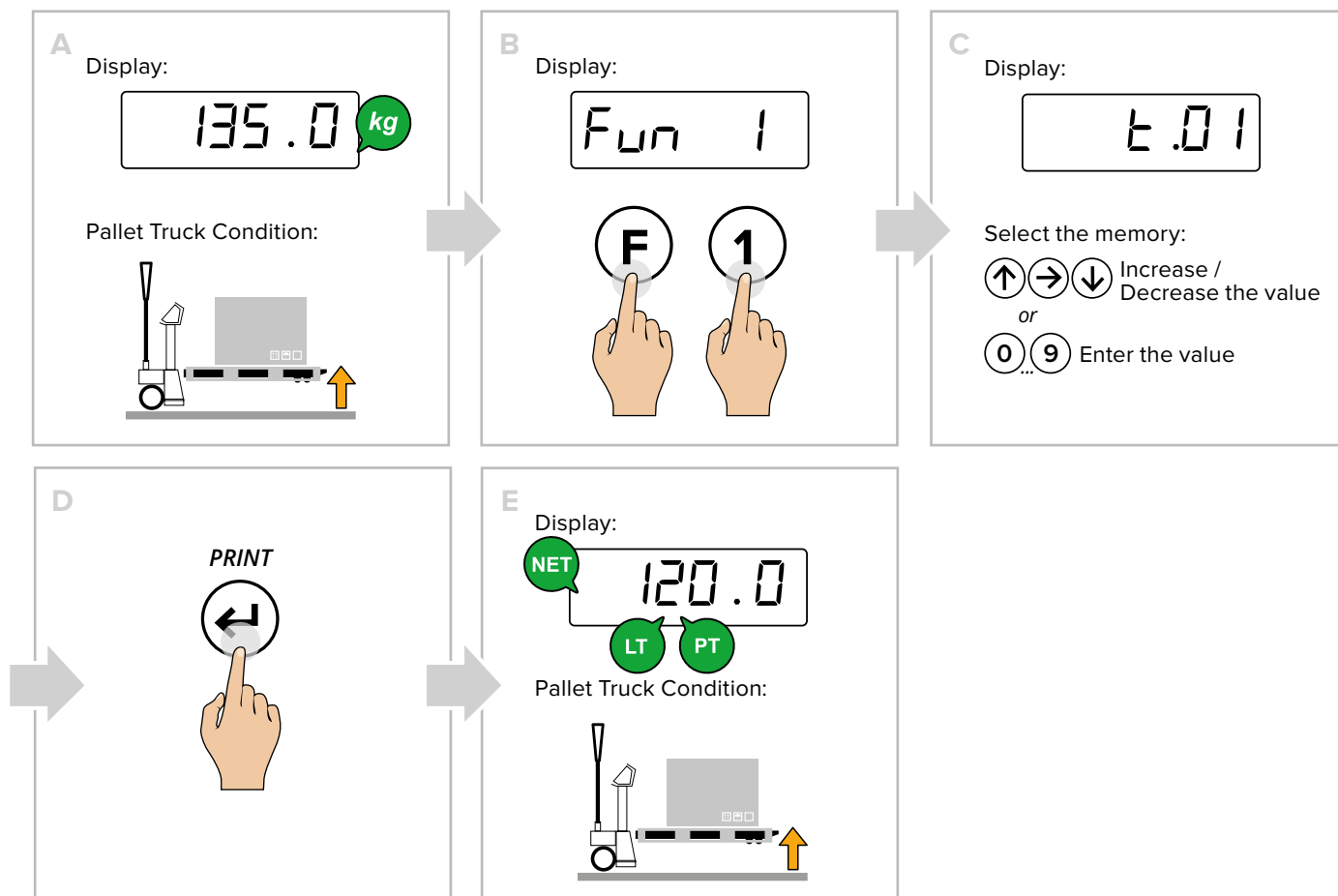

Automatic tare deletion

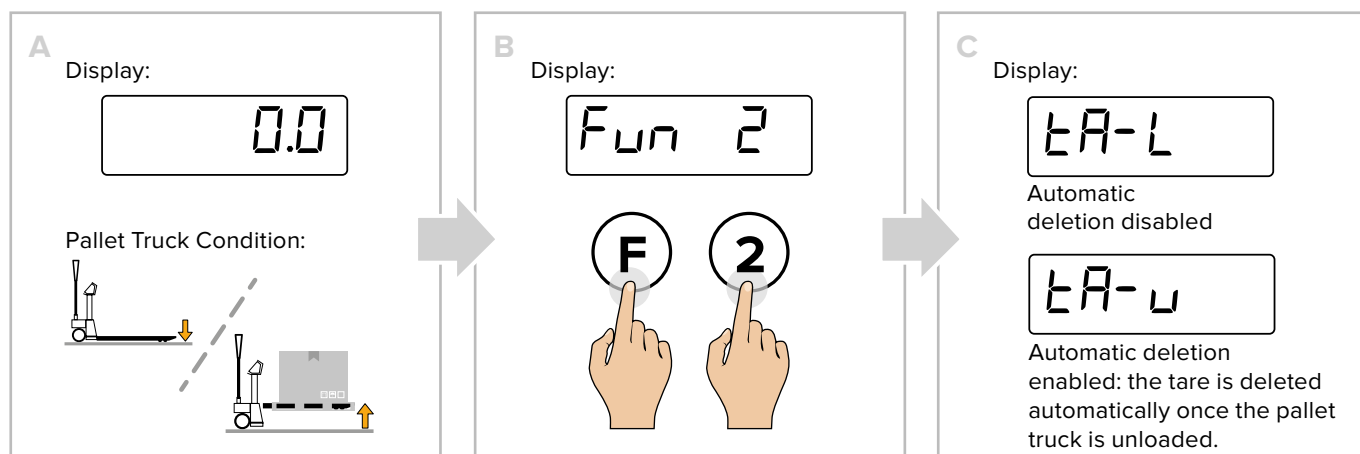

Number IDs

The instrument has 2 memories for the temporary recording of numerical codes that can be used to identify the product, the operator, the batch, etc. These codes, if entered, will be shown on the receipt at the time of printing.

HOW TO ENTER THE ID

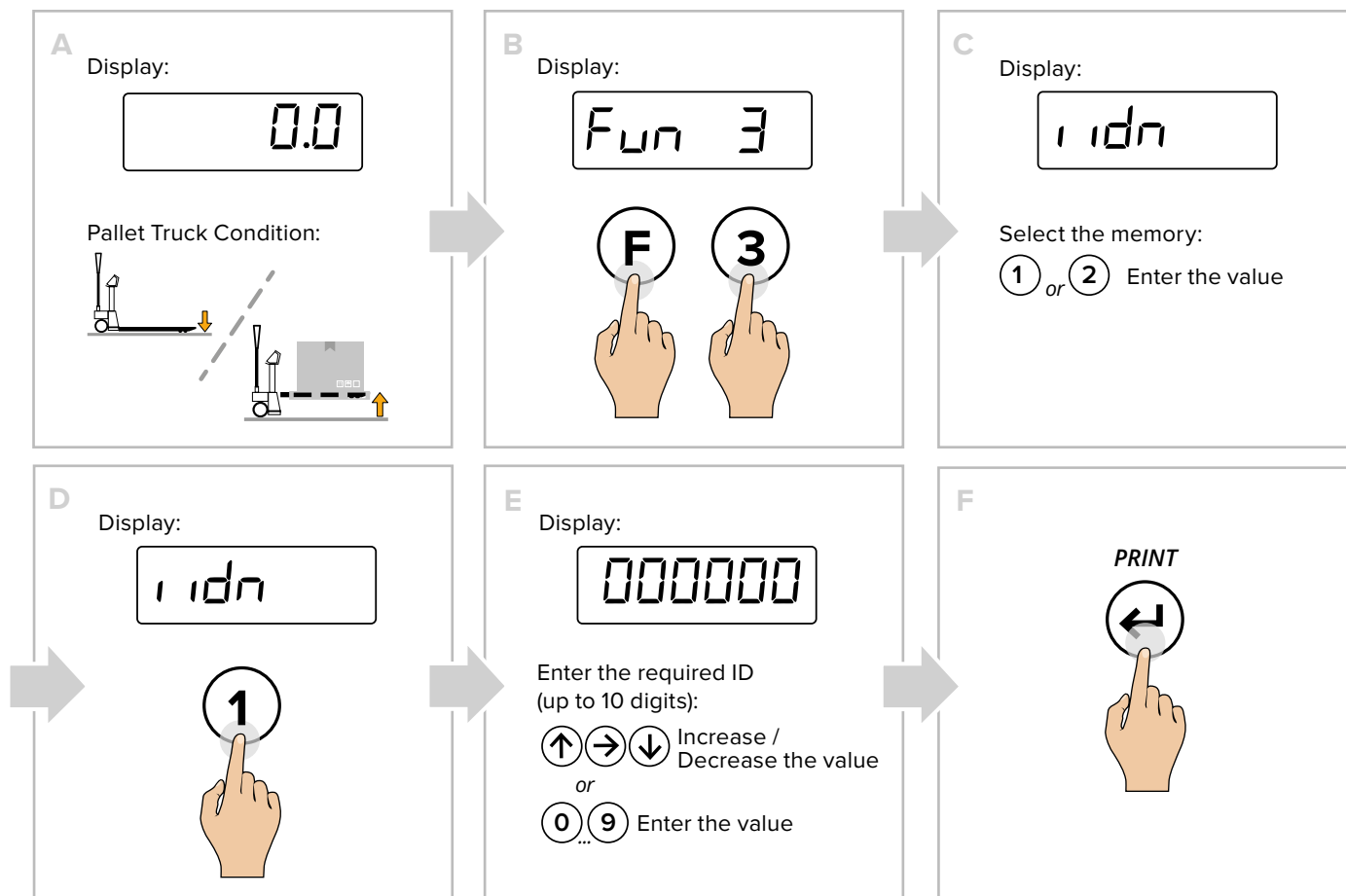

HOW TO ENABLE AUTOMATIC ID DELETION

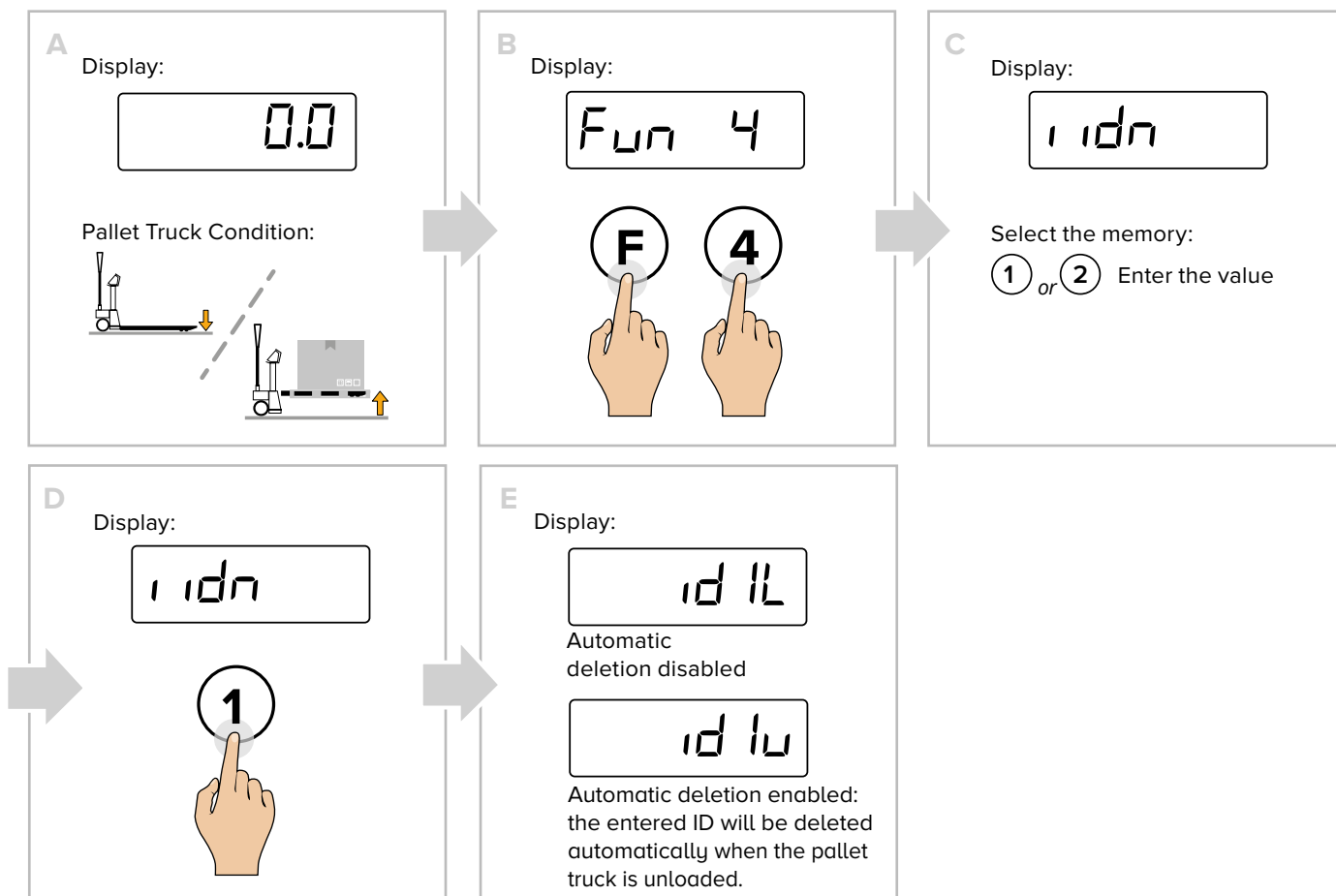

The numeric IDs are automatically reset when the scale is turned off.

Date and time

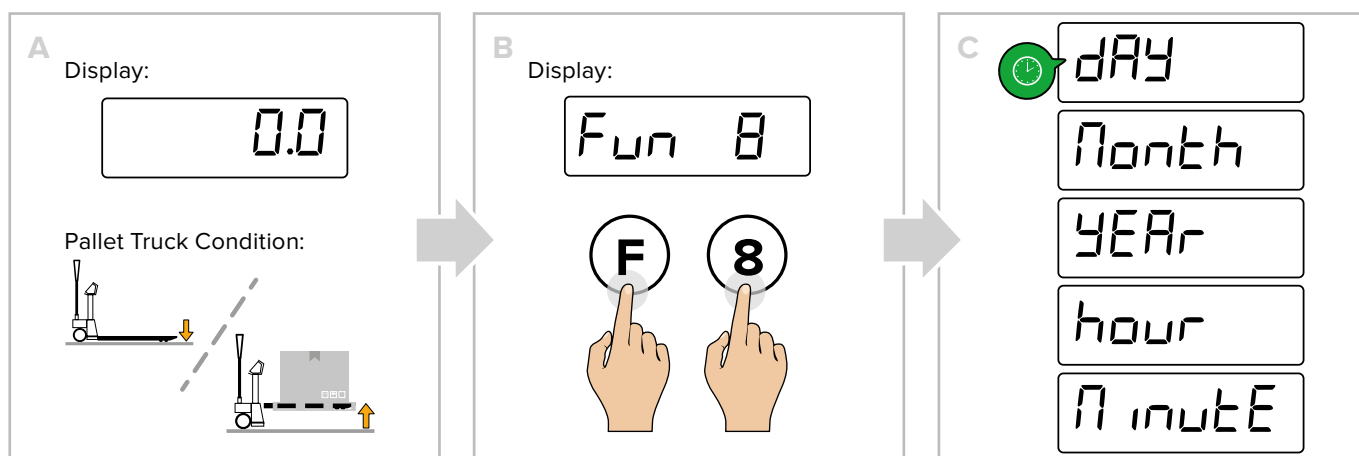

Only if the date and time option is available.



Print (and reprint of last receipt)

PRINT

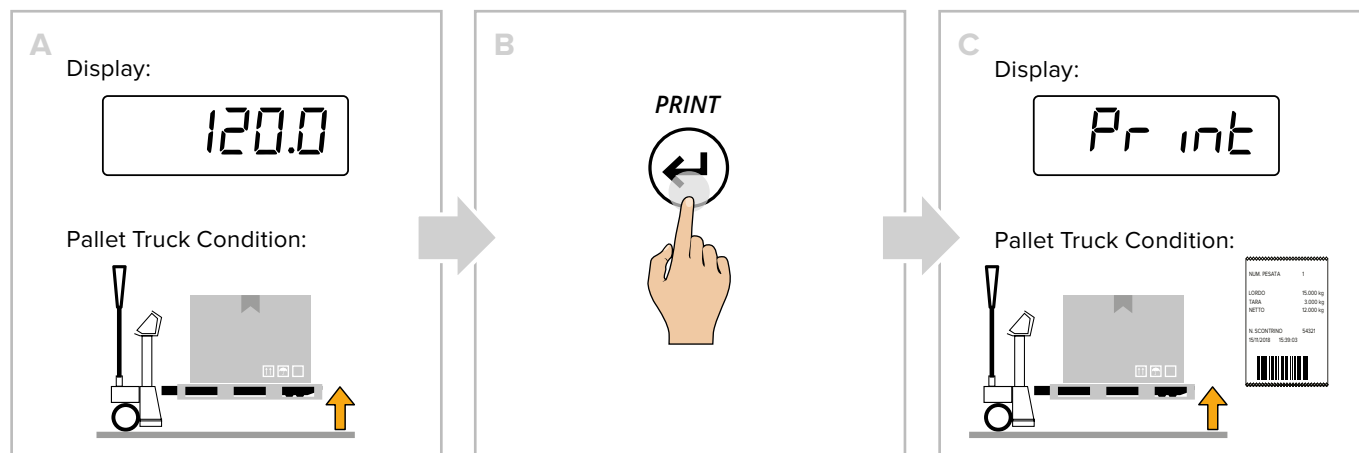

REPRINT OF LAST RECEIPT

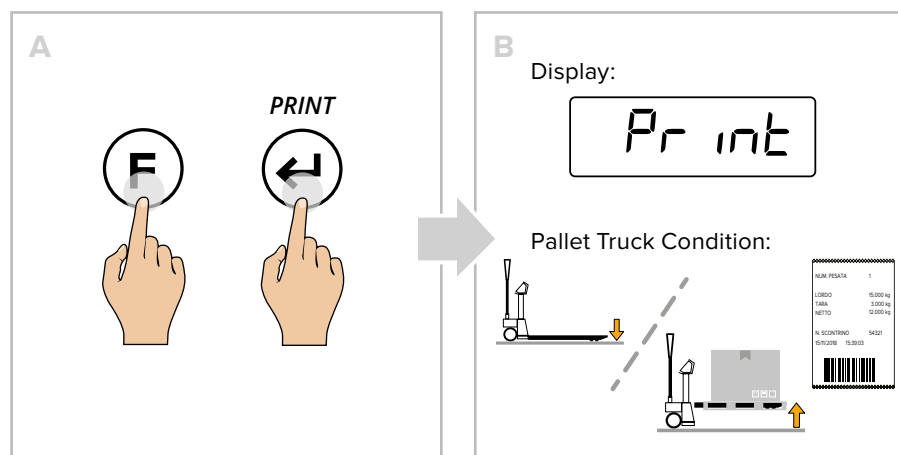

Metrics

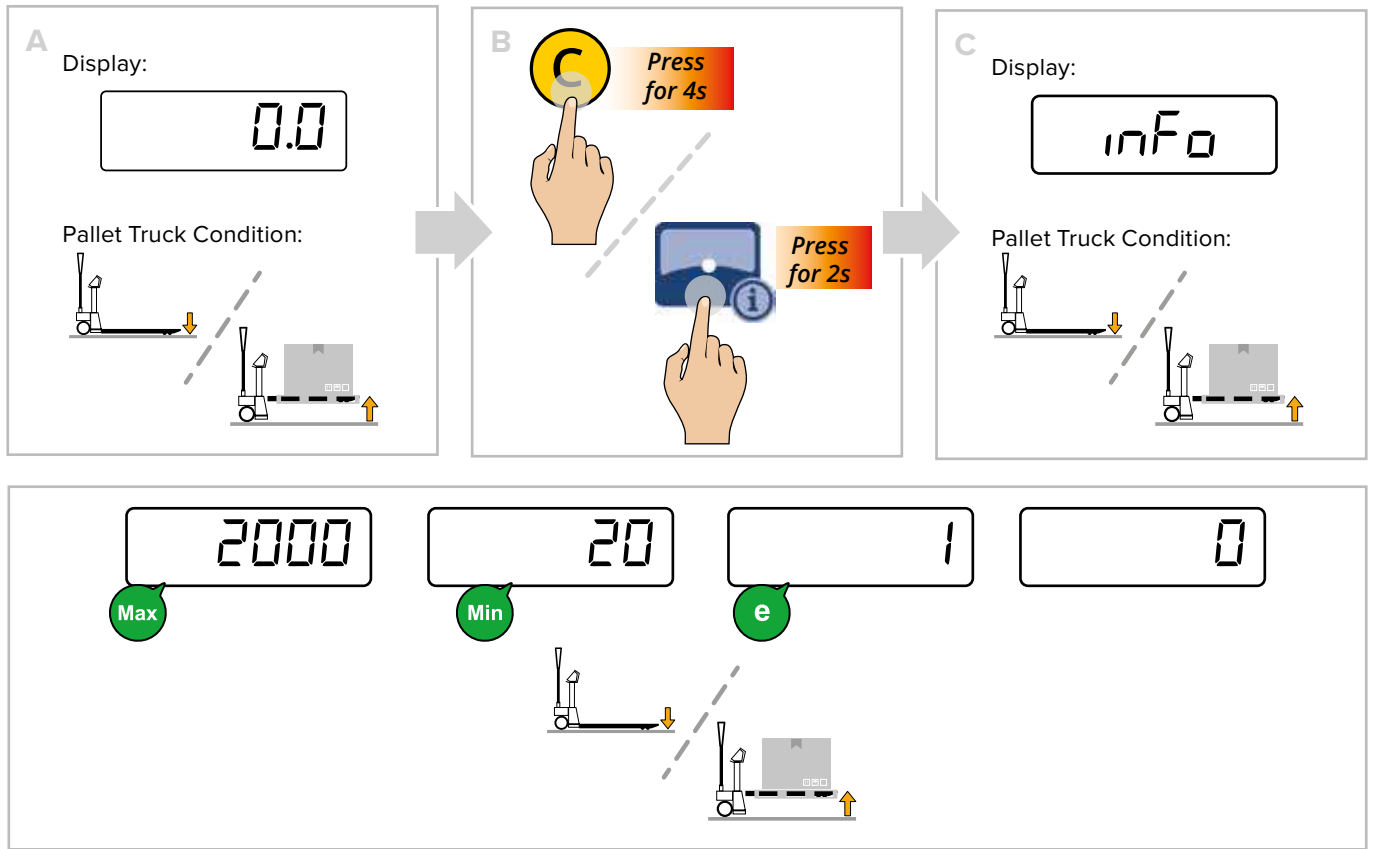

ADVANCED SCALE FUNCTIONS

How to access the function menu

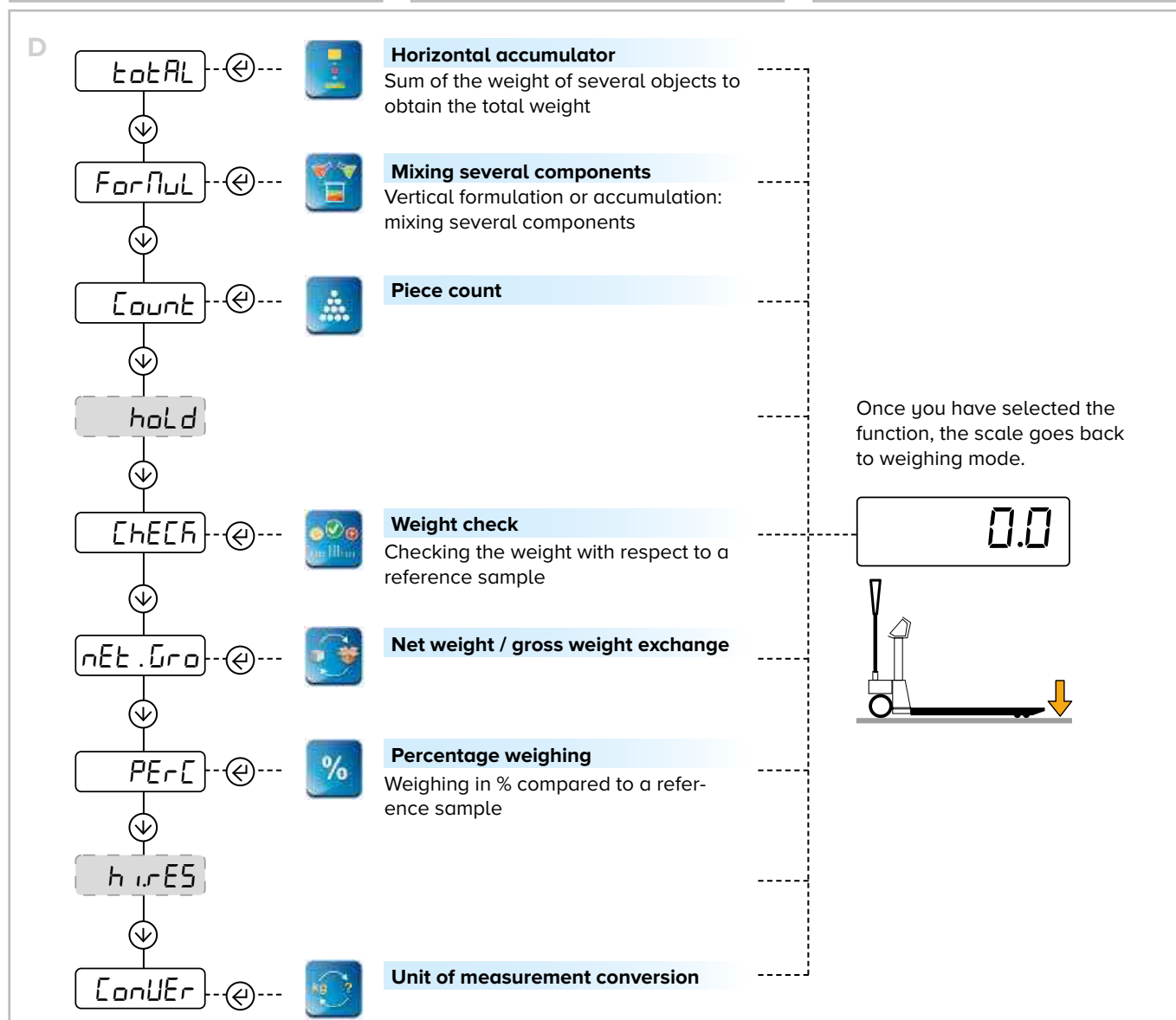
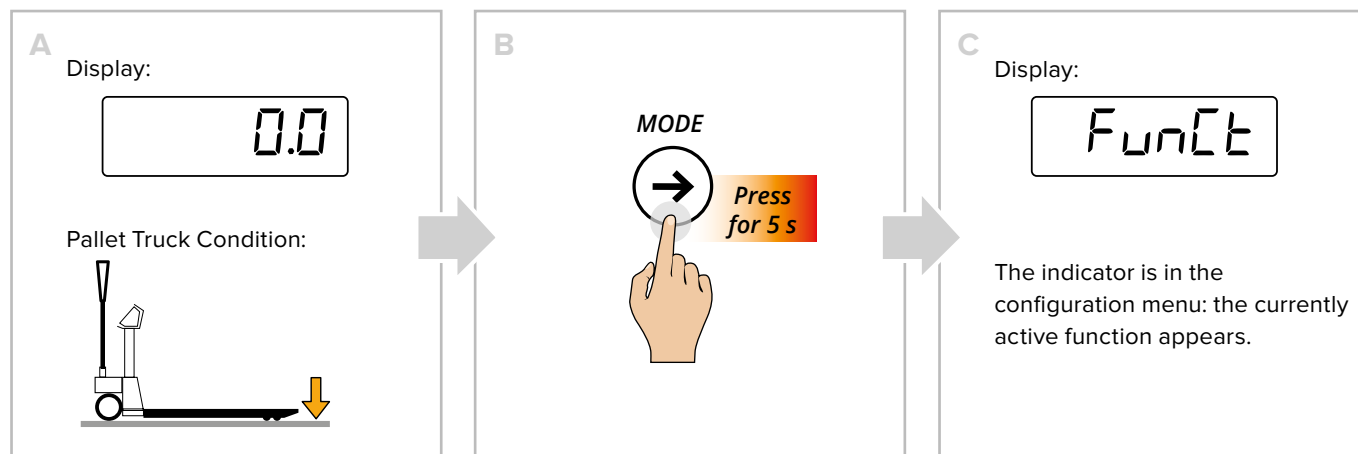

Horizontal accumulator

HOW TO ADD UP THE WEIGHINGS

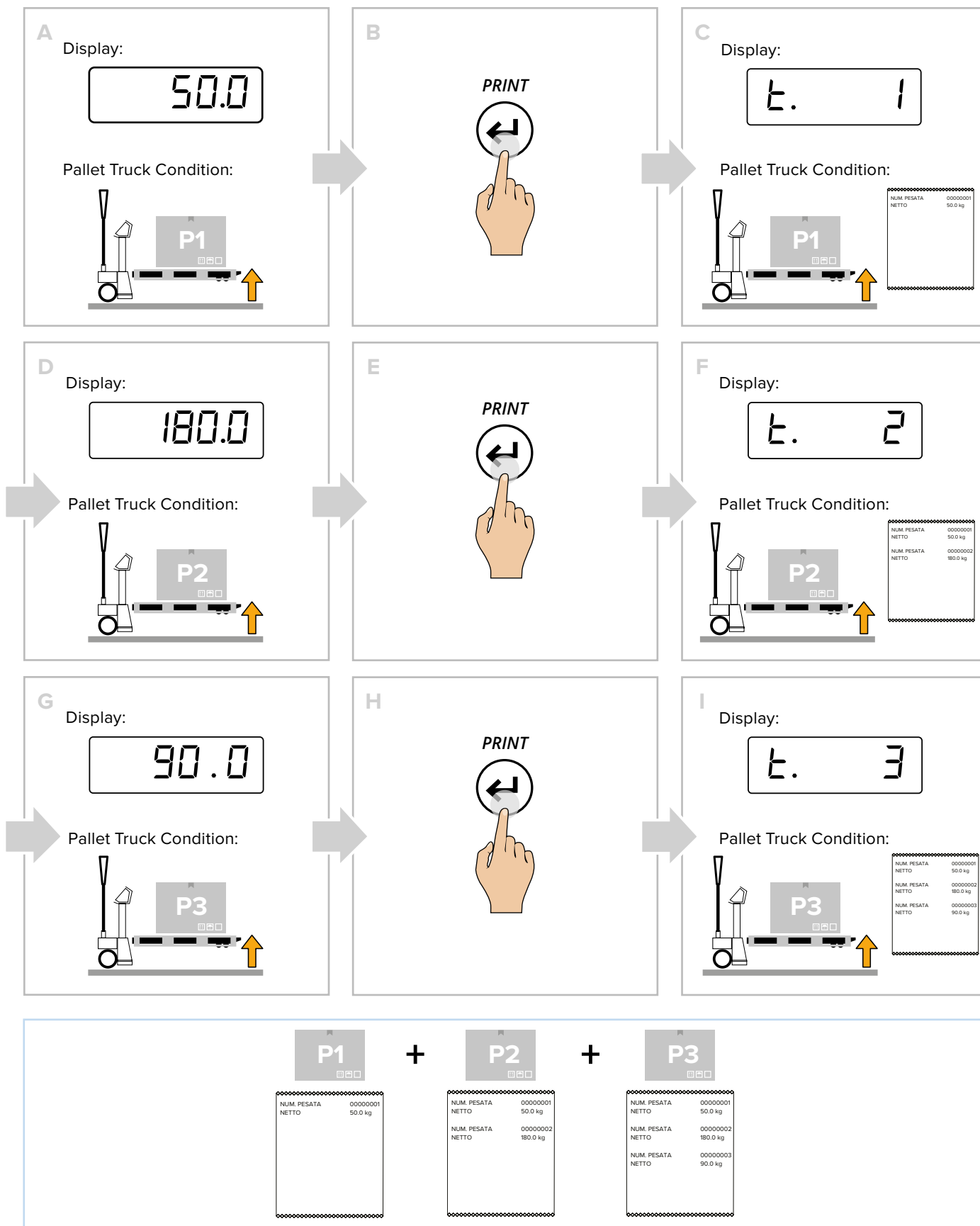

HOW TO MOMENTARILY READ THE TOTAL

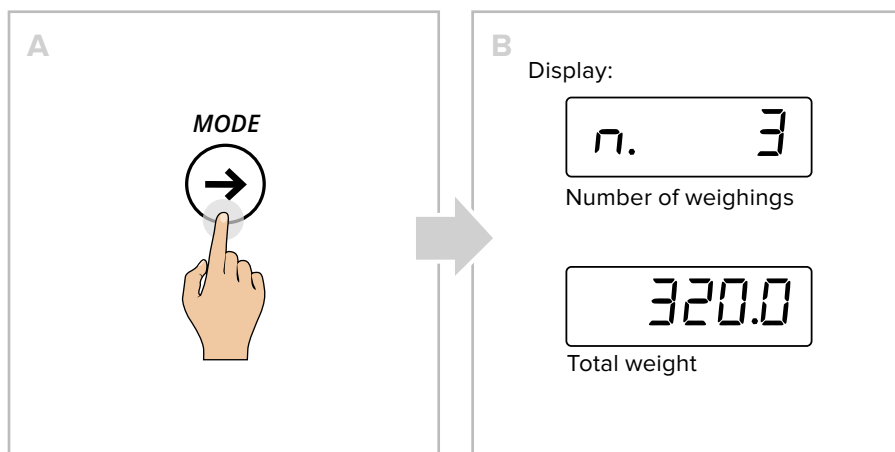

i With the number keyboard, pressing (F) + (7) displays the current total without printing it/resetting it.

HOW TO END ACCUMULATION AND RESET THE TOTAL

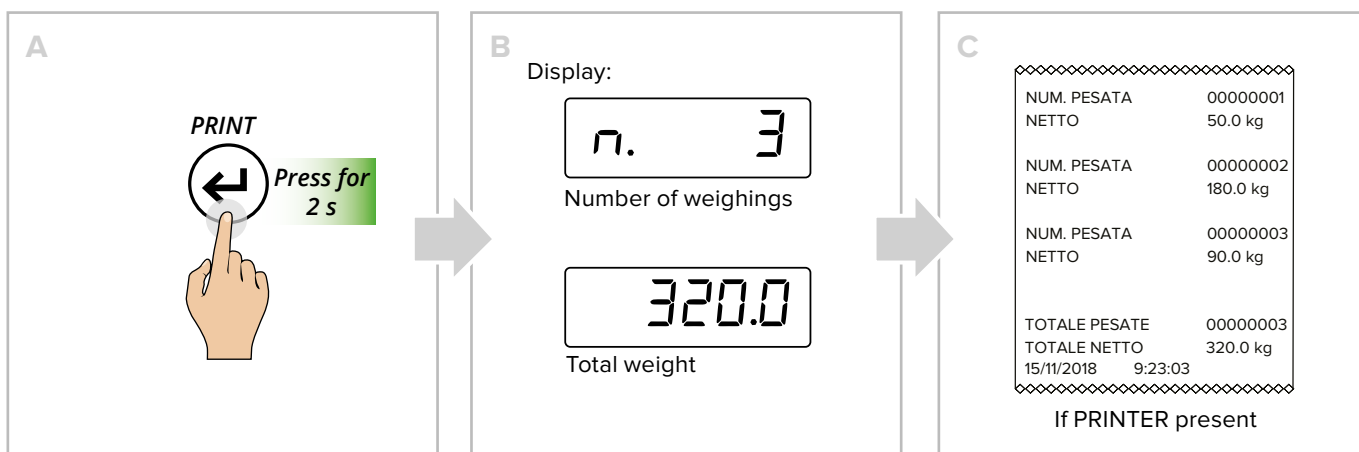

i With the number keyboard, pressing (F) + (7) displays the current total without printing it/resetting it.

HOW TO PRINT AND RESET THE GRAND TOTAL

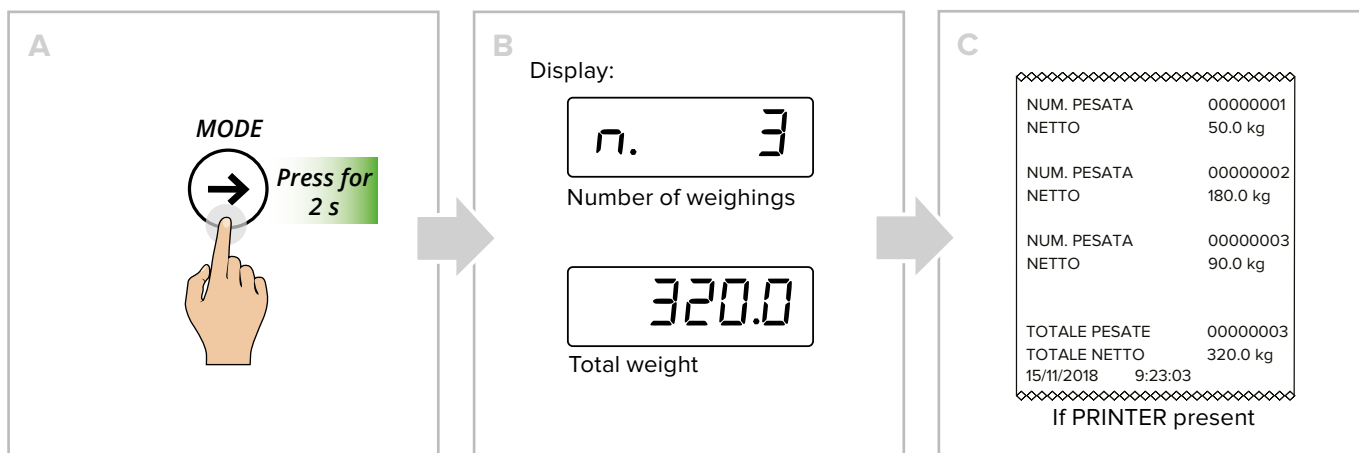

i With the number keyboard, pressing (F) + (6) displays the current total without printing it/resetting it.

Mixing several components

HOW TO ADD UP THE WEIGHINGS

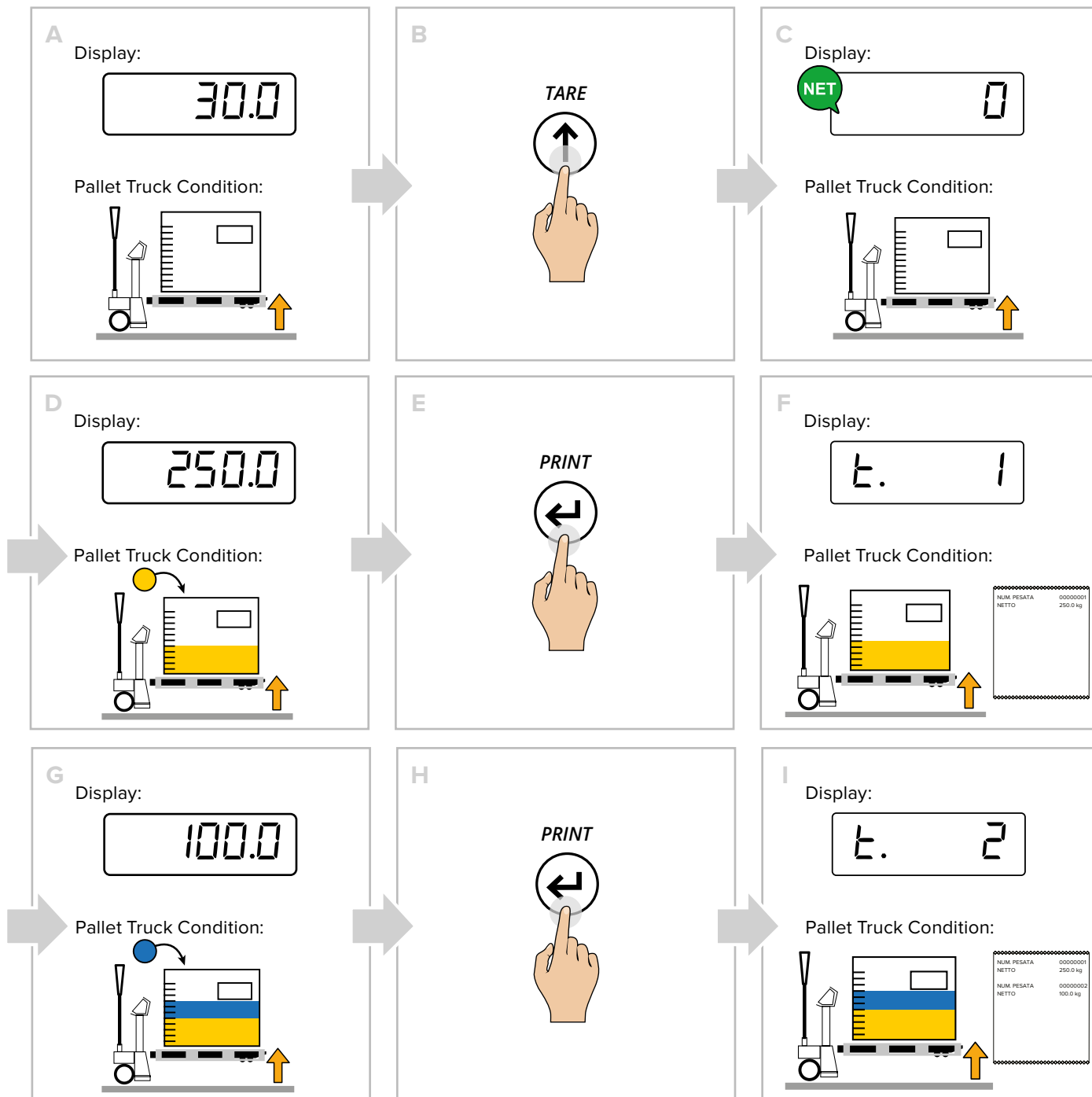

HOW TO MOMENTARILY READ THE TOTAL

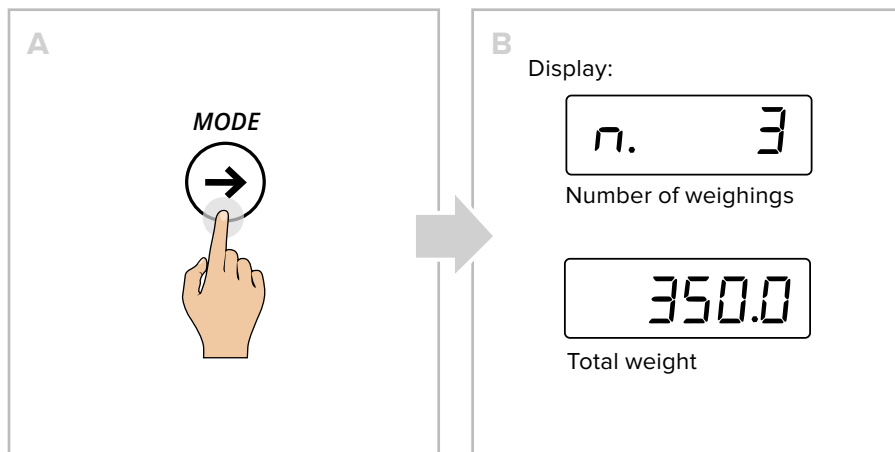

i With the number keyboard, pressing (F) + (7) displays the current total without printing it/resetting it.

HOW TO END ACCUMULATION AND RESET THE TOTAL

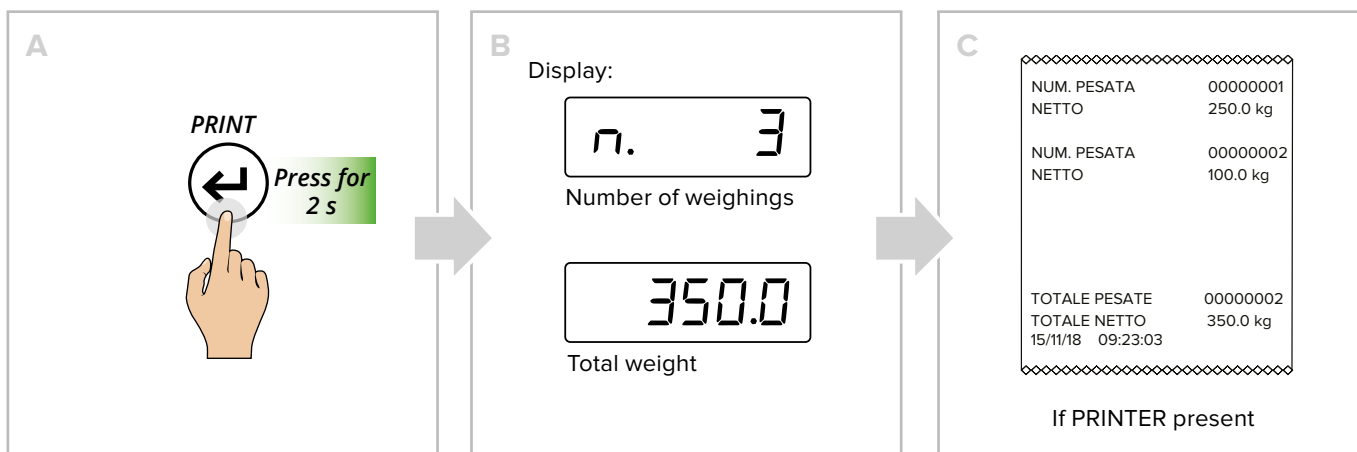

i With the number keyboard, pressing (F) + (7) displays the current total without printing it/resetting it.

HOW TO PRINT AND RESET THE GRAND TOTAL

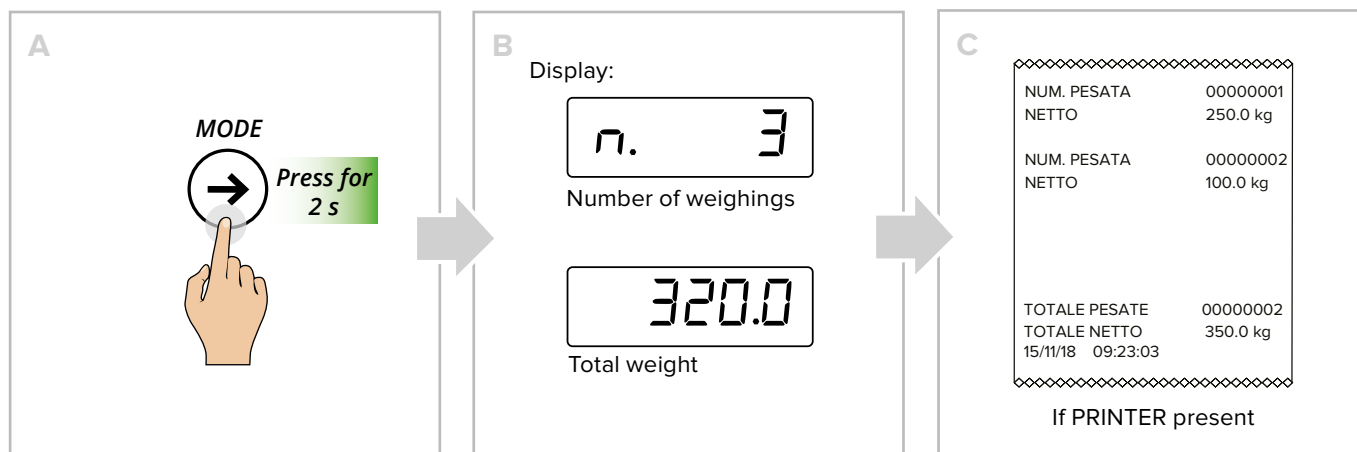

i With the number keyboard, pressing (F) + (6) displays the current total without printing it/resetting it.

Piece count

HOW TO SAMPLE AND COUNT

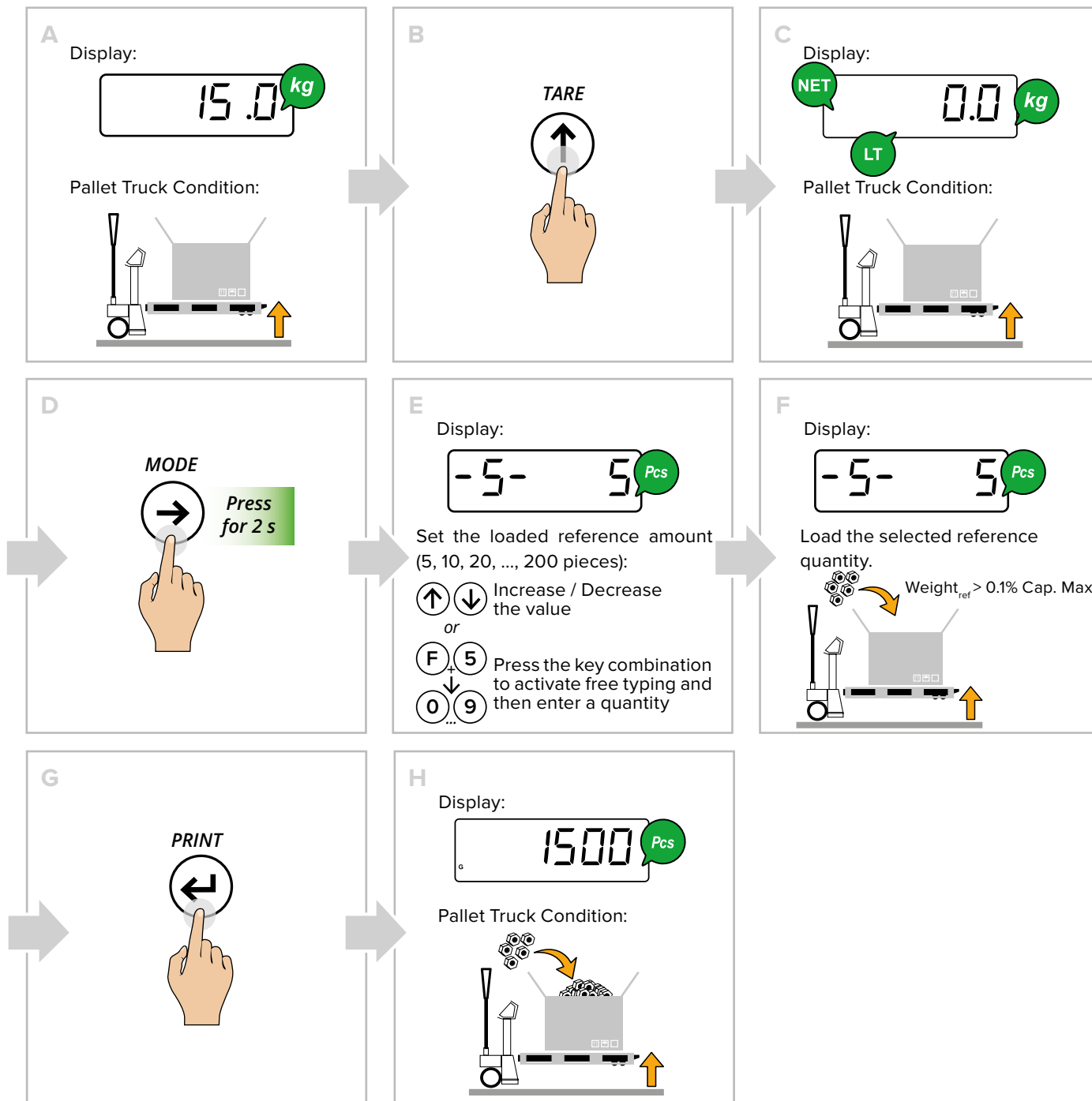

HOW TO SWITCH FROM PIECE TO WEIGHT DISPLAY AND VICE VERSA

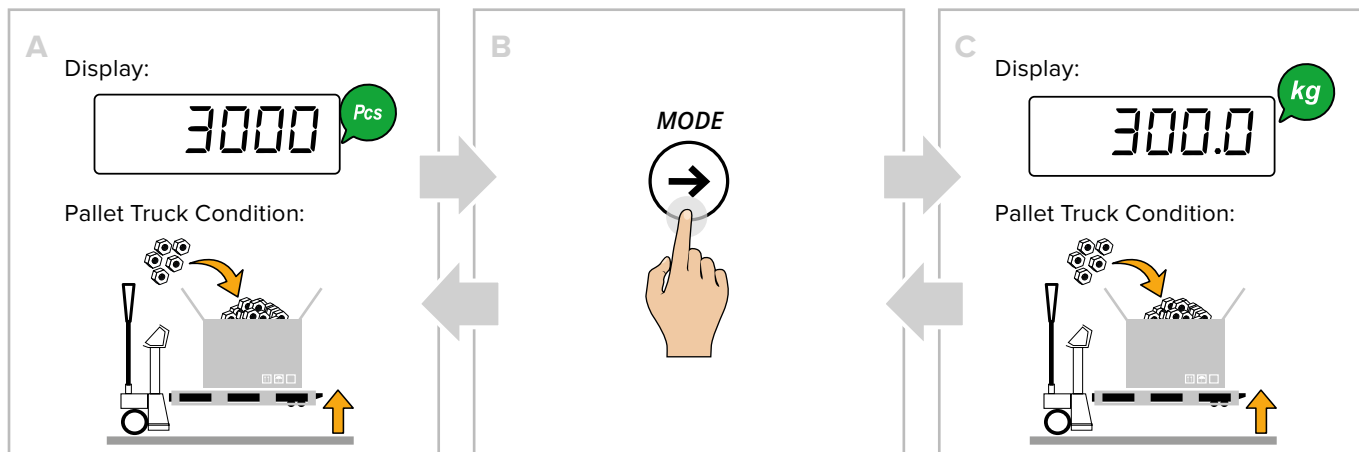

You can go from counting to weighing at any time by pressing

HOW TO ENTER THE AVERAGE UNIT WEIGHT (PMU)

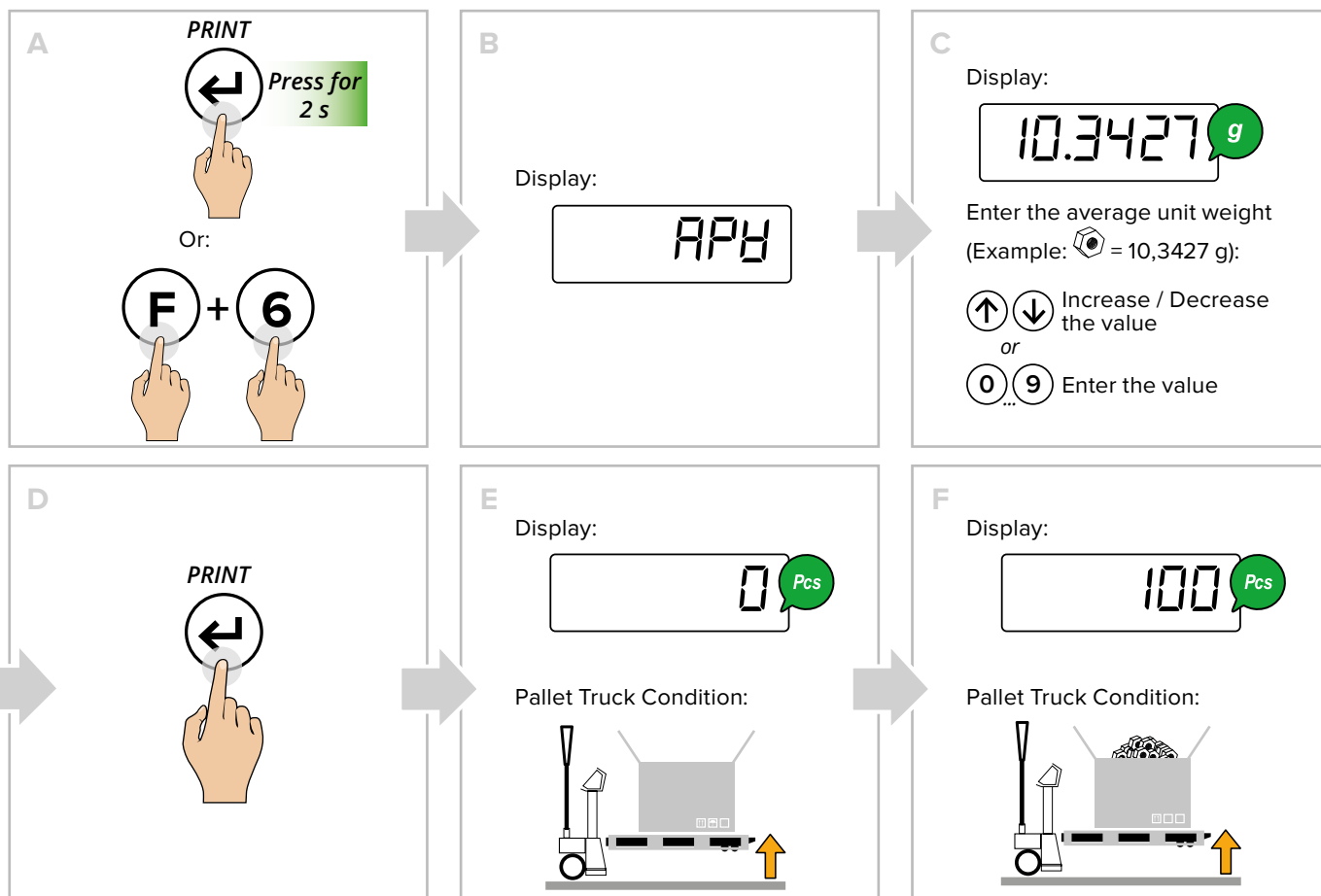





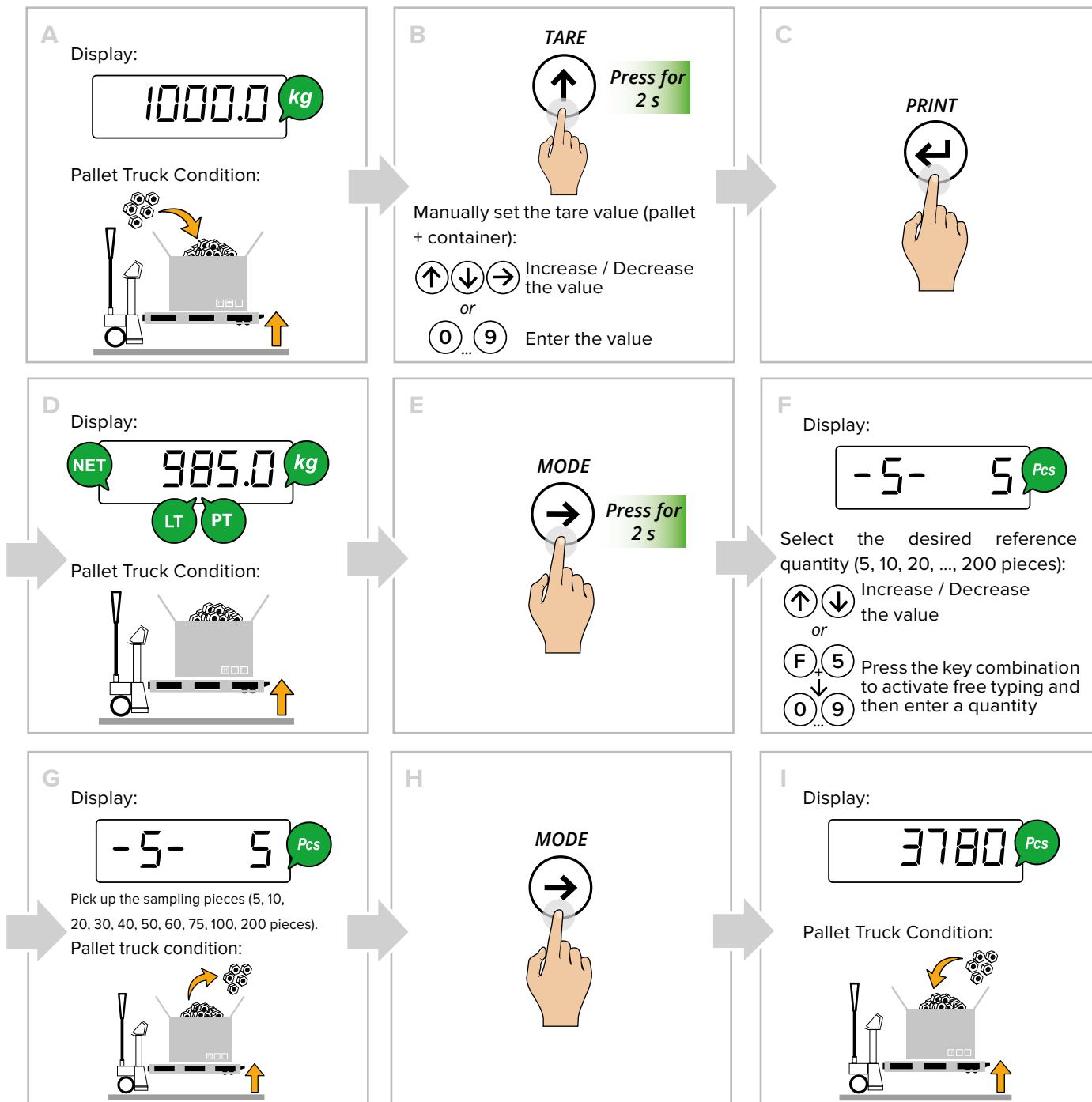





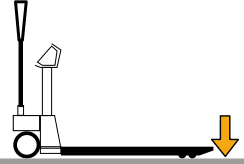

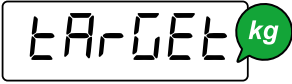











For correct counting, you must set the known tare value or tare the empty container and fill it with the pieces to count.

TOTAL LOAD COUNT



Weight check

HOW TO START THE CHECK WITH KNOWN REFERENCE WEIGHT

<p>A</p> <p>Display:</p>  <p>Pallet Truck Condition:</p> 	<p>B</p> <p>MODE</p>  <p>Press for 2 s</p>	<p>C</p> <p>Display:</p> 
<p>D</p> <p>Display:</p>  <p>Manually set the value:</p> <p>    Increase / Decrease the value or  ...  Enter the value </p>	<p>E</p> <p>PRINT</p> 	<p>F</p> <p>Display:</p>  <p>Enter the lower tolerance:</p> <p>    Increase / Decrease the value or  ...  Enter the value </p>
<p>G</p> <p>PRINT</p> 	<p>H</p> <p>Display:</p>  <p>Enter the higher tolerance:</p> <p>    Increase / Decrease the value or  ...  Enter the value </p>	<p>I</p> <p>PRINT</p> 
<p>Example 1: To check a weight of 1000 g with +/- 5 g tolerance (that is, between 995 g and 1005 g), set:</p> <pre> t0 1000 L00005 h00005 </pre>		<p>Example 2: To check a weight of 500 g with +/- 10 g / -20 g tolerance (that is, between 480 g and 510 g), set:</p> <pre> t00500 L000020 h000 10 </pre>

HOW TO START THE CHECK WITH AUTOMATIC TARGET ACQUISITION

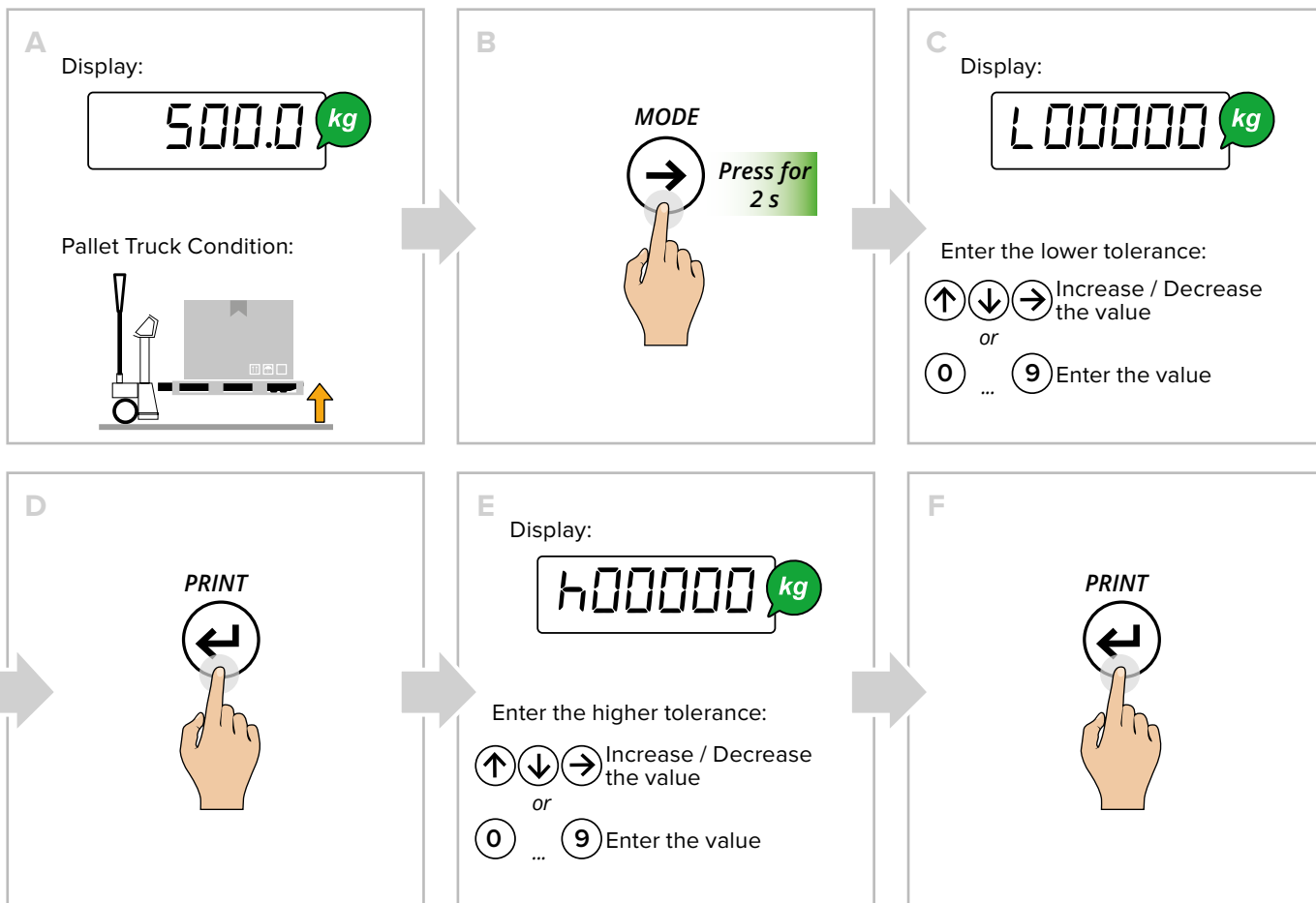

HOW TO CHECK THE WEIGHT

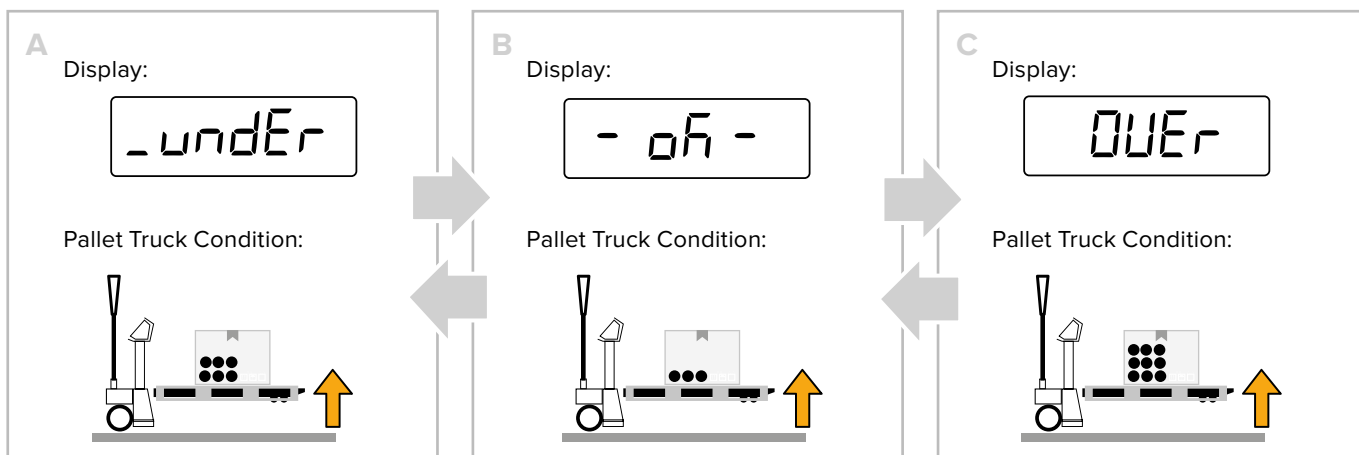

HOW TO UPDATE THE NOMINAL WEIGHT WITH KNOWN REFERENCE WEIGHT

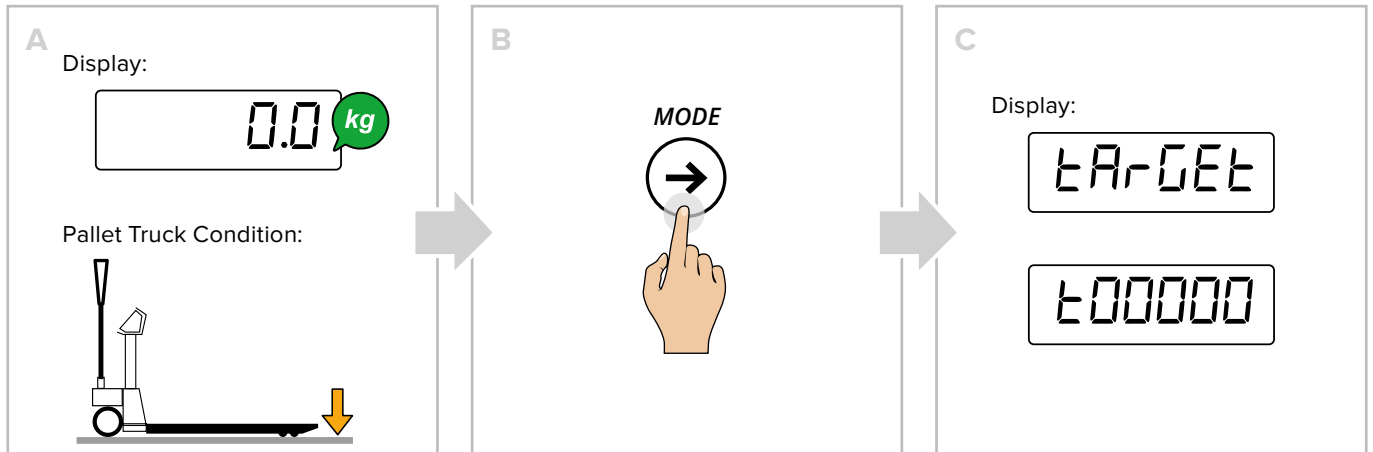

HOW TO UPDATE THE NOMINAL WEIGHT WITH AUTOMATIC TARGET ACQUISITION

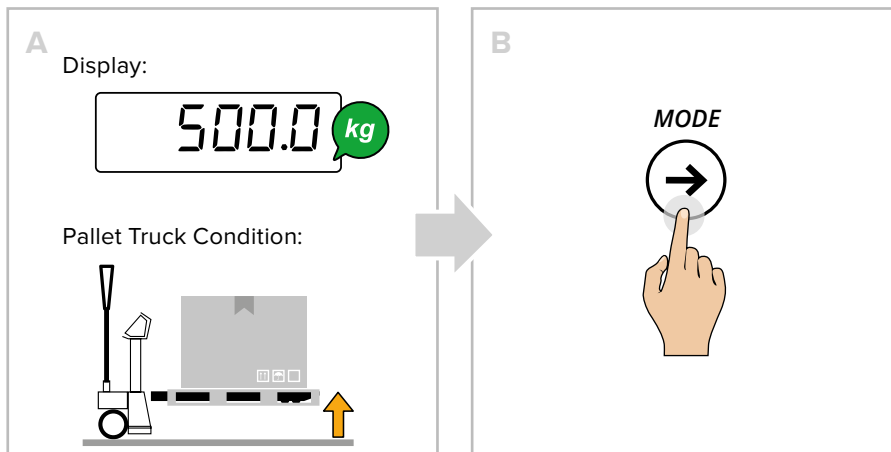

HOW TO EDIT THE CHECK THRESHOLDS

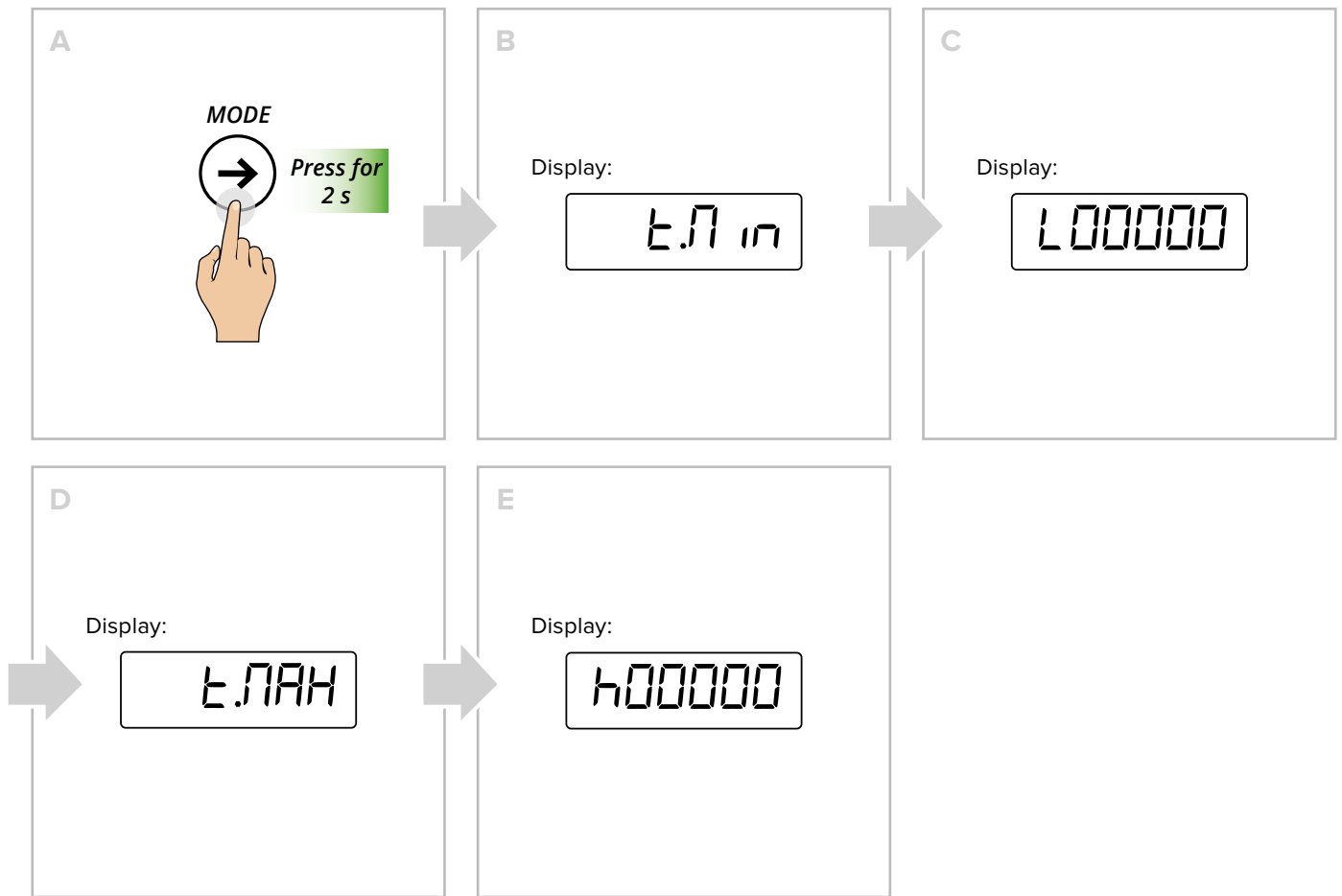

Exchange between net weight and gross weight

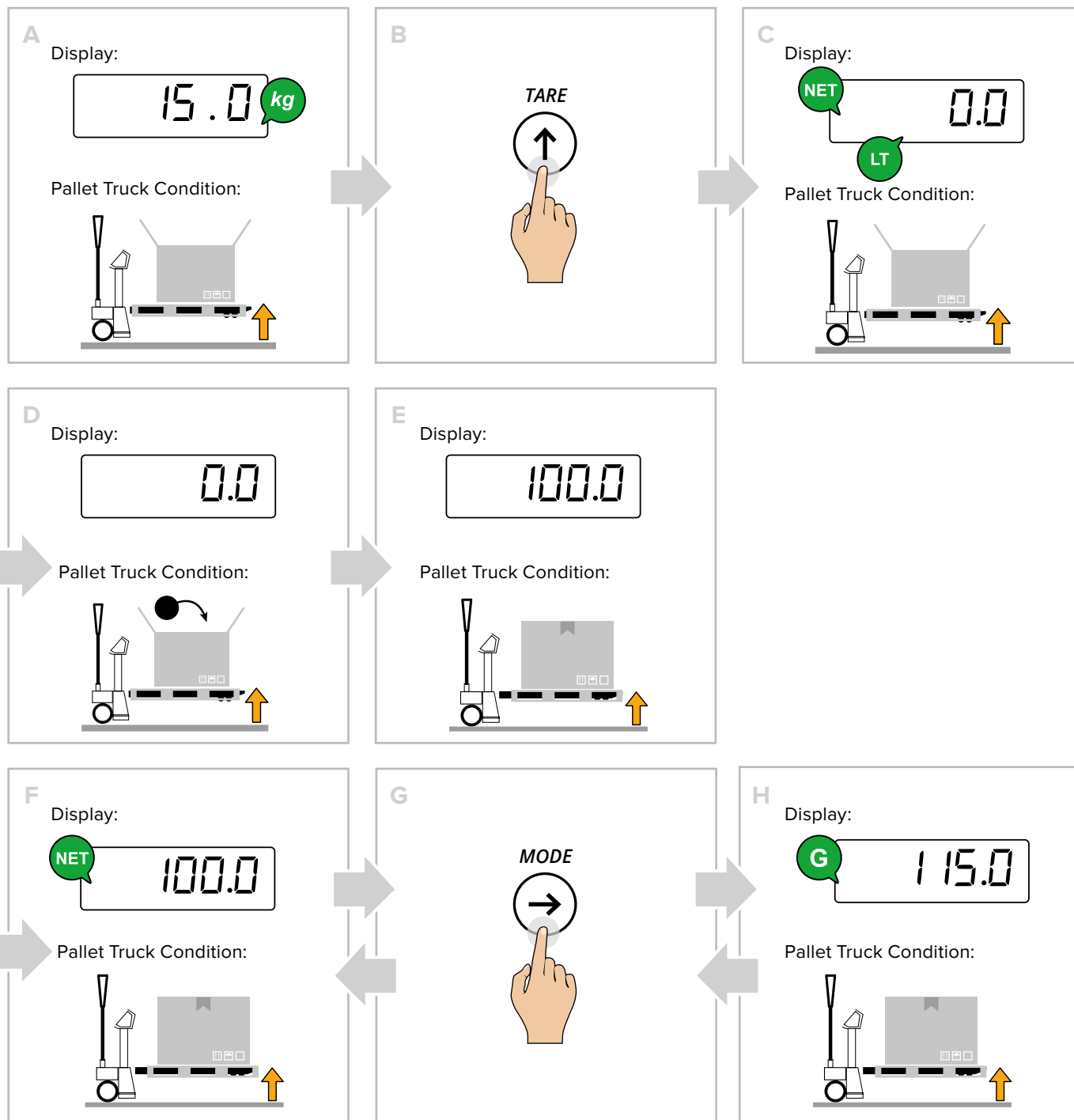

You can go from net weight to gross weight at any time by pressing ^{MODE} →.



Percentage weighing

PERCENTAGE CHECK

I. How to acquire the 100% reference

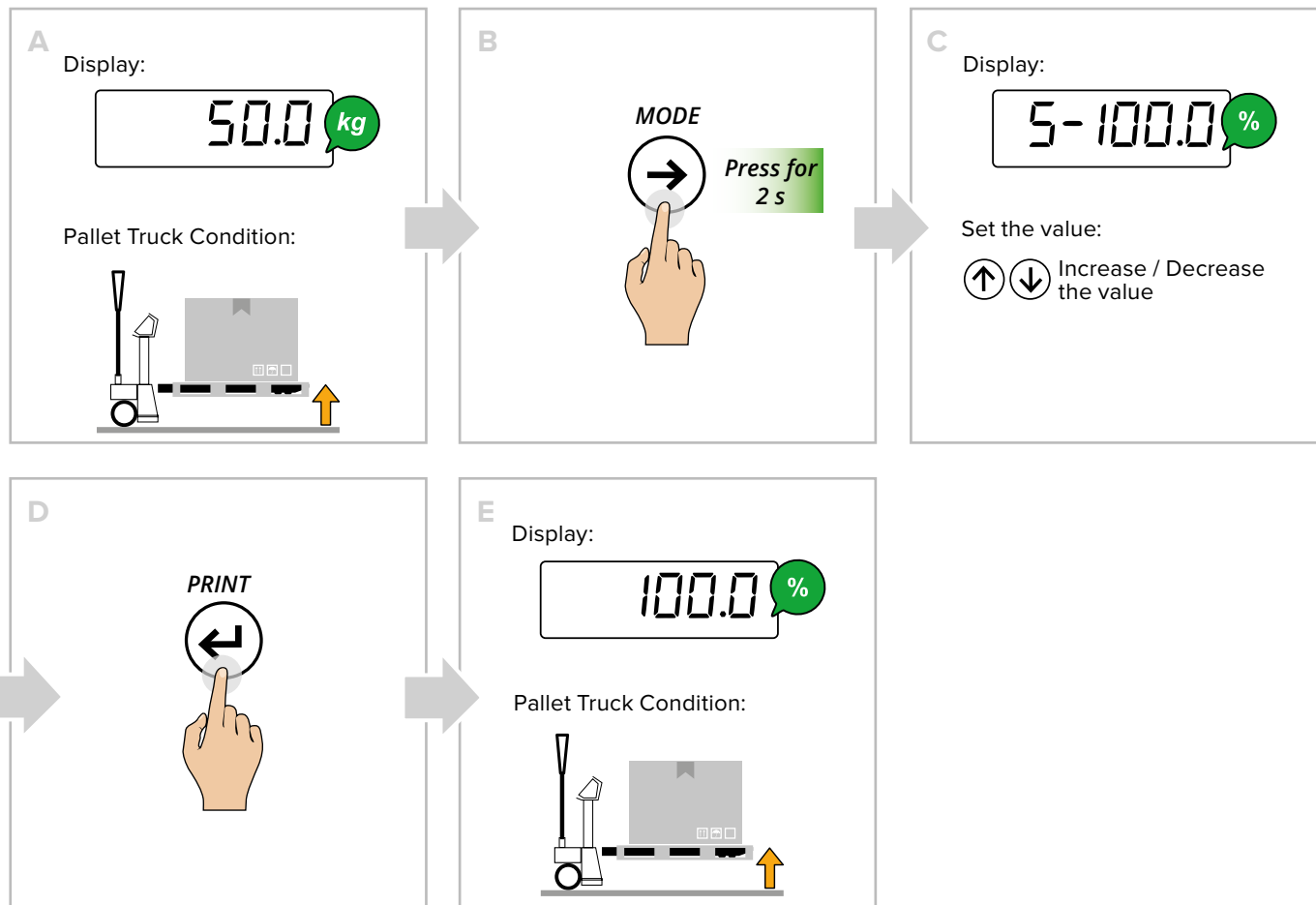

II. How to check the weight

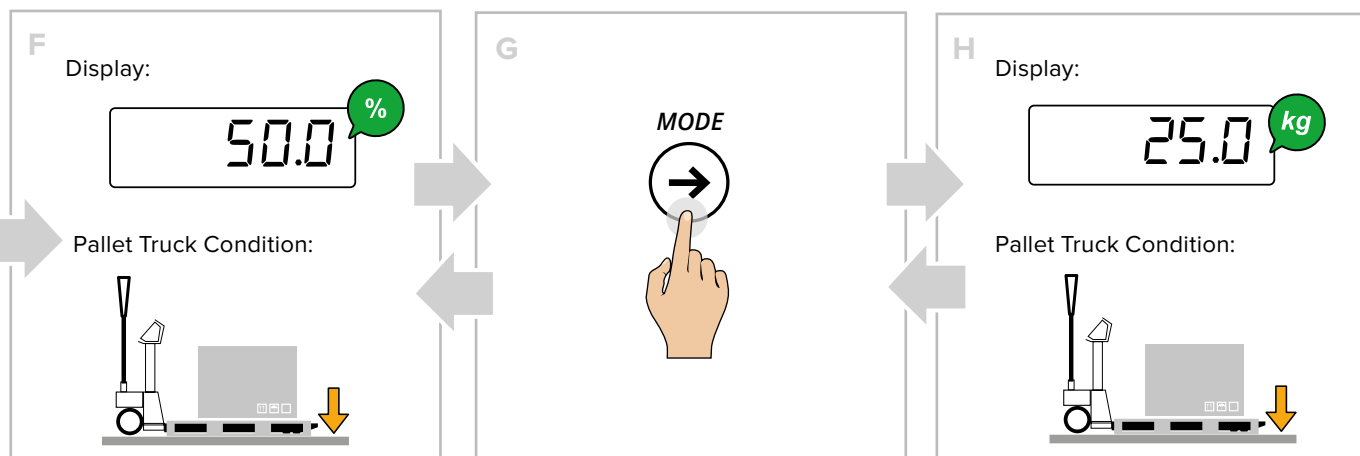

You can go from weight in % to weight in kg at any time by pressing .

PERCENTAGE METERING

Example of formula:

Product: RP28K

1. 2127A3 - 50%

2. 23AB4 - 30%

3. Water - 20%

Meter 500 kg

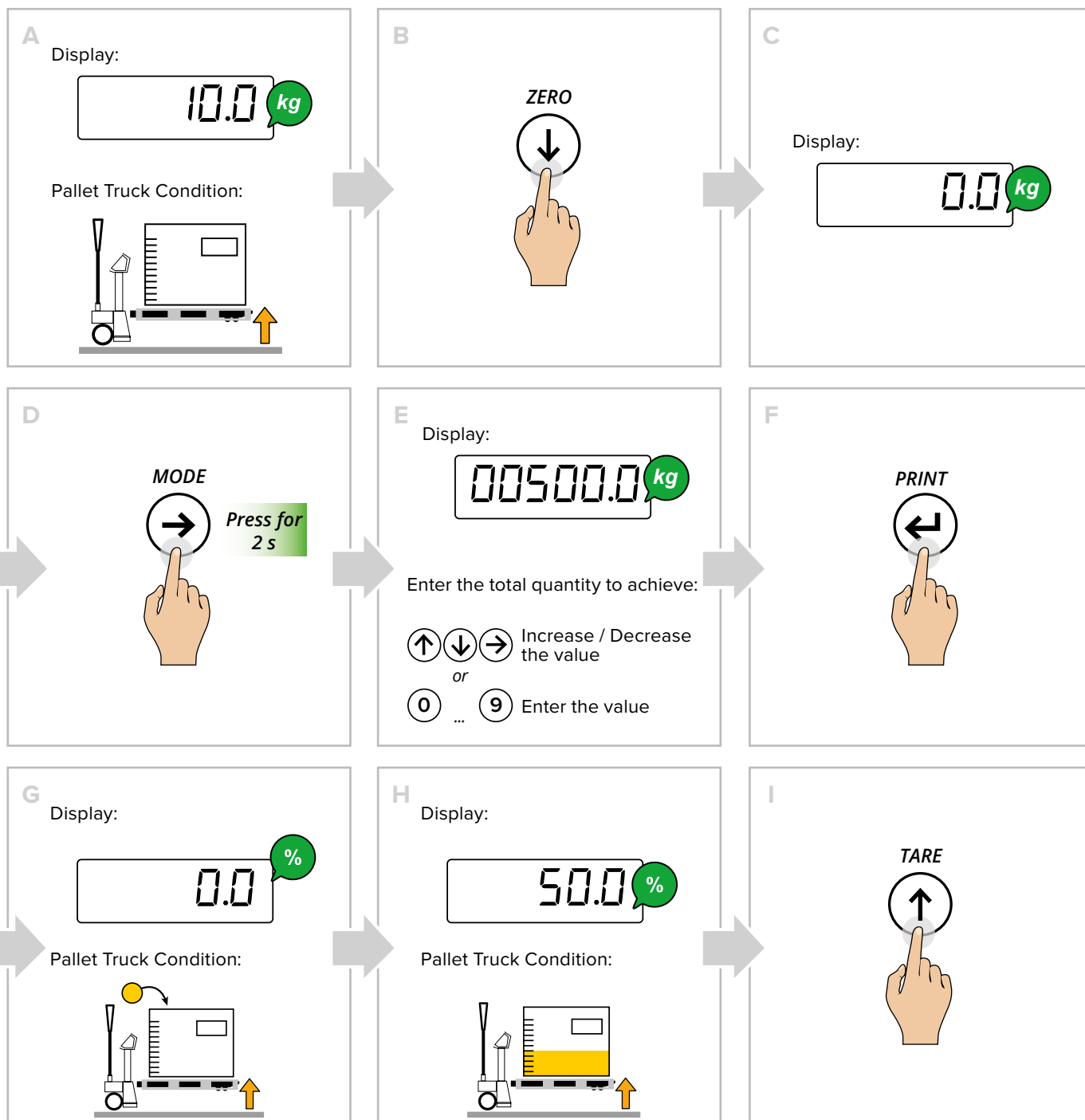

continue →

J

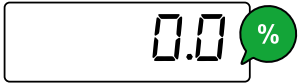
Display: 

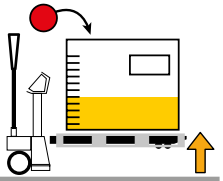
Pallet Truck Condition: 

K

Display: 

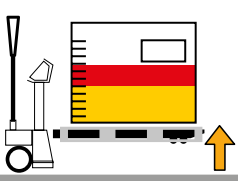
Pallet Truck Condition: 

L





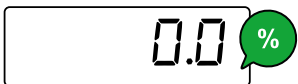

M

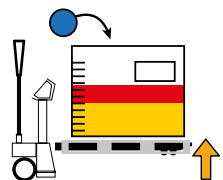
Display: 

Pallet Truck Condition: 

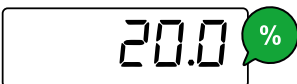
N

Display: 

Pallet Truck Condition: 

O







P

Display: 

Pallet Truck Condition: 

Q





R

Display: 

Pallet Truck Condition: 



You can go from weight in % to weight in kg at any time by pressing ^{MODE} .

Unit of measurement conversion

HOW TO CONVERT THE UNIT OF MEASUREMENT INTO POUNDS (STANDARD MODE)

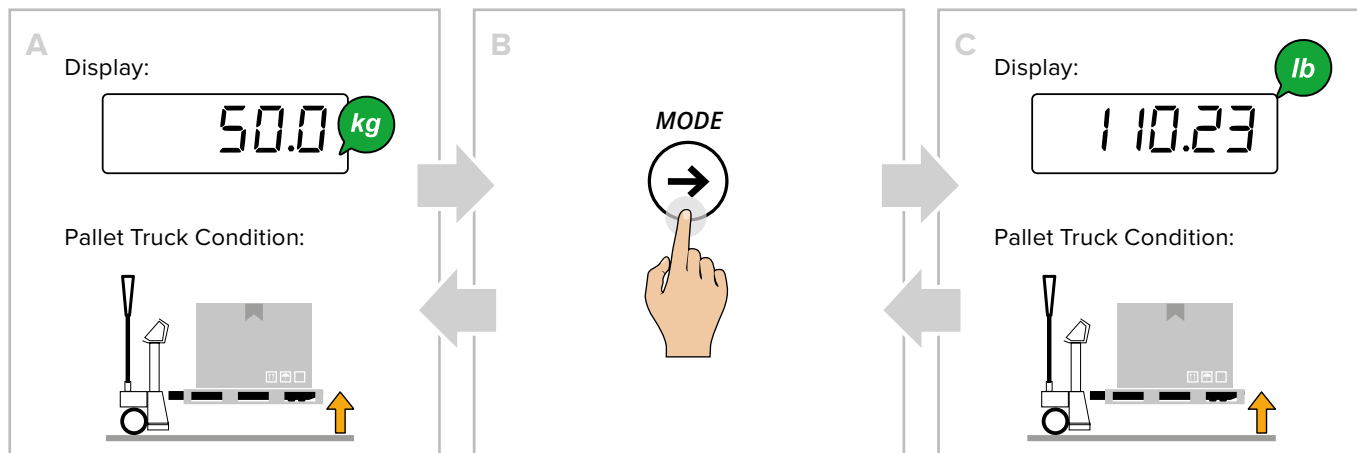

You can go from weight in kg to weight in pounds at any time by pressing .

HOW TO CONVERT THE UNIT OF MEASUREMENT WITH FREE CONVERSION FACTOR

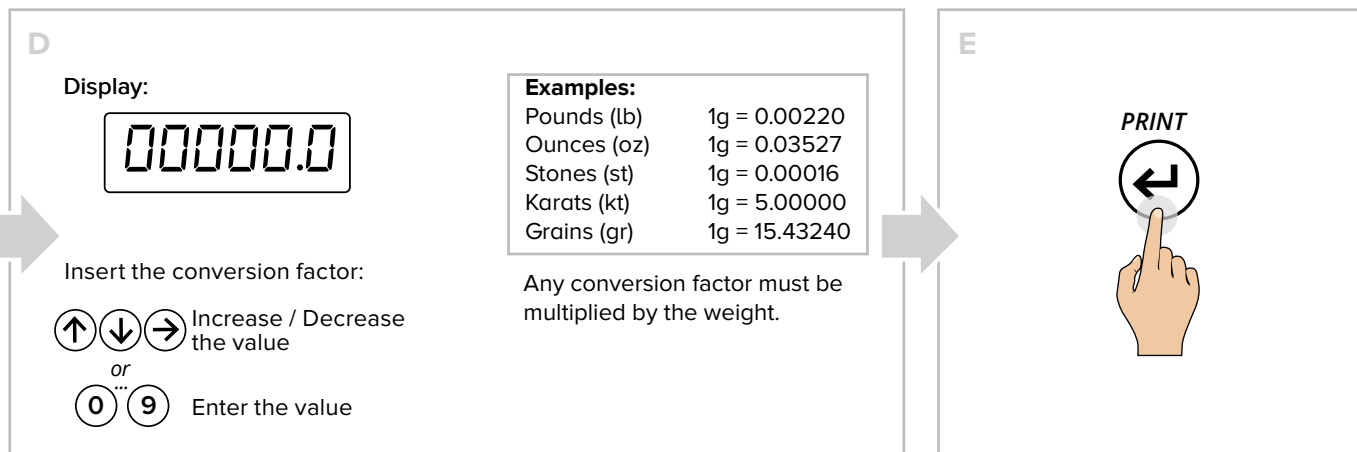
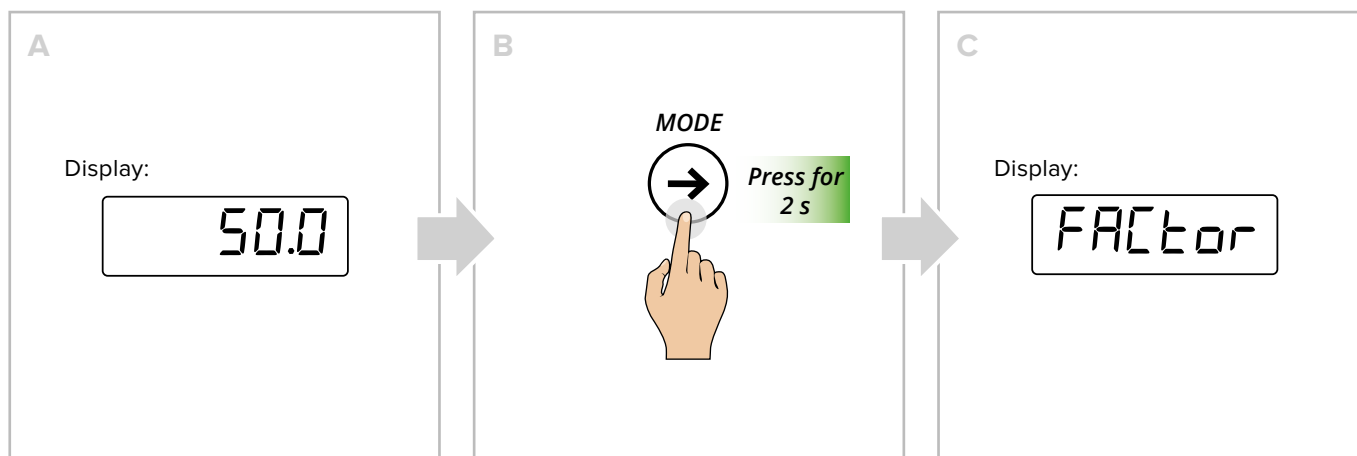

continue 

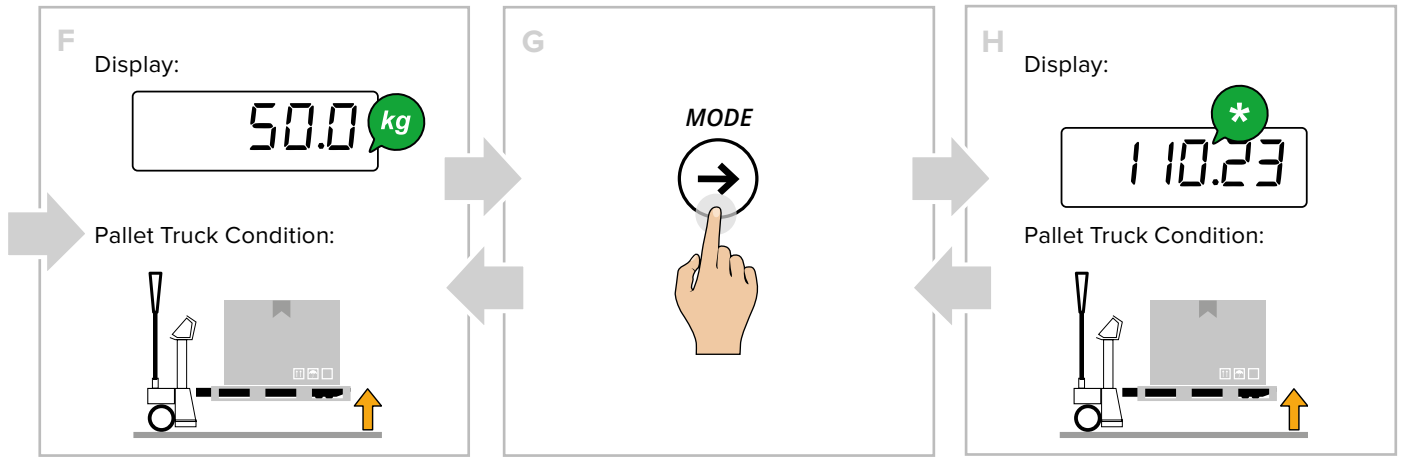

i You can convert the unit of measurement with free conversion factor at any time by pressing **MODE** .

METROLOGICAL SCALE INFORMATION

1. Turn off the scale

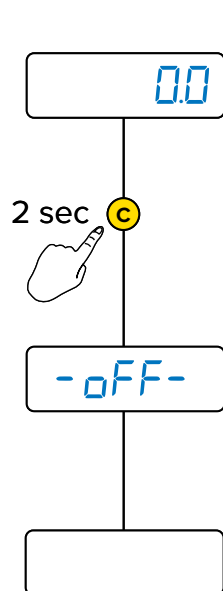

2. Follow the procedure:

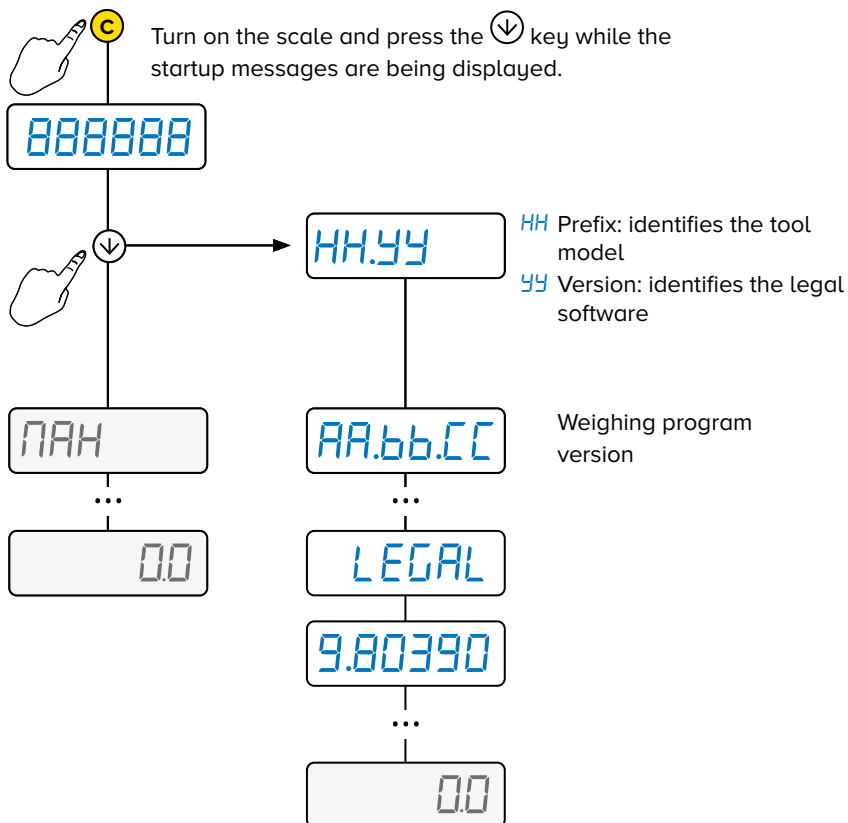

MAINTENANCE

Maintenance warnings



WARNING!

Perform maintenance operations when the machine is switched off and in a safe condition.



WARNING!

Maintenance operations must be performed by qualified and authorised personnel.

Machine maintenance includes the operations (inspection, verification, control, adjustment and replacement) that become necessary following normal use.

- During maintenance operations do not release work residues into the environment.
- Only perform the maintenance operations described herein, any unspecified procedures can pose a serious risk to untrained operators and in any case alter the machine's degree of safety.
- Always and only use original spare parts.
- During operation or maintenance, plates and stickers must NOT be removed, hidden, or made illegible.
- The maintenance technicians must wear all the personal protective equipment required for the operation to be carried out.



WARNING!

Repair or maintenance operations not contained in this manual may only be carried out with the prior authorisation of DINI ARGEO

No responsibility for damage to persons or property may be attributed to DINI ARGEO for operations other than those described or carried out in ways other than those indicated.

Machine maintenance operations are divided, from the operational point of view, into two main categories:

Scheduled Maintenance	All those operations that the operator must perform, in a preventive manner, to ensure good operation of the machine over time; scheduled maintenance includes inspection, control, adjustment, cleaning and lubrication.
Unscheduled Maintenance	All those operations that the operator must perform when the machine requires it. Unscheduled maintenance includes the overhaul, repair, restoration of nominal operating conditions or the replacement of a faulty, defective or worn out unit.

Scheduled maintenance

The machine, when delivered to the user, is already adjusted to work properly; however, in order to ensure its proper functioning over time, it is required to carry out periodic and preventive checks and maintenance.

The **scheduled maintenance** includes inspections, checks and operations that, to prevent breakdowns, keep under control:

- the mechanical conditions of the machine,
- the lubrication of the machine,
- the cleaning of the machine.



WARNING!

Before starting the maintenance operations, place the Pallet Truck on a solid and flat surface.

Scheduled maintenance table



IMPORTANT!

Scheduled maintenance operations to be carried out daily are the responsibility of the operator responsible for driving the pallet truck.

Operation	Frequency			
	Daily	Weekly	Monthly	Biannual
Roller and wheel integrity check	◆			
Visual check of the state of the truck frame	◆			
Weight indicator operation check	◆			
Integrated printer operation check (if present)	◆			
Pump operation check	◆			
Greasing the bearings of the rollers and wheels			◆	
Greasing the tiller control lever guide				◆
Chain greasing with spray				◆
Greasing the lifting system			◆	
Oil level check				◆
Wheel cleaning		◆		
General cleaning of the machine with compressed air and non-pressurised water Note: in non-IP models, do not use water on the battery and on the interface.		◆		



Oil level top-up

Tank top-up for models with pump with plug

Check the oil level every 6 months.

Only use hydraulic oil (not motor or brake oil) to top-up.

	Oil viscosity:	30 CST at 40°C
	Total volume:	0.3 l

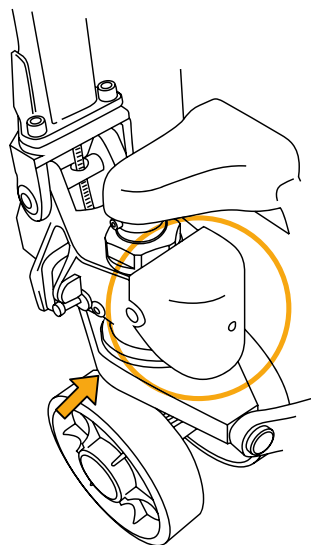

- A. Fully lower the forks.
- B. Remove the protective casing, the seal and the cap.
- C. If required, add up to 20 mm from the top edge of the tank.
- D. Operate the pump several times to release any air from the hydraulic circuit, then lower the forks completely.
- E. Put the cap, the seal and the protective casing back on.

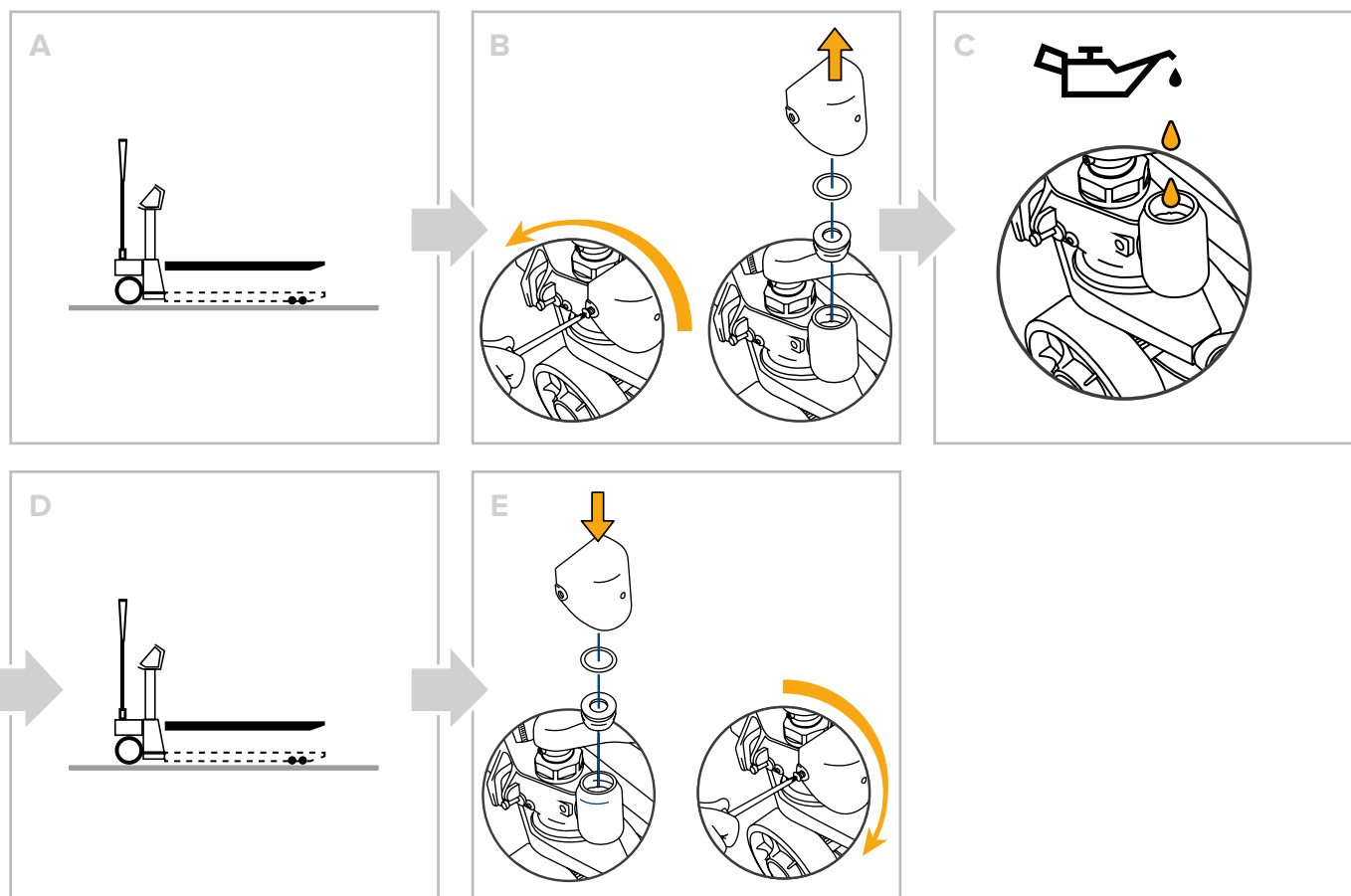

Tank top-up by means of syringe for models with mono-block pump

Check the oil level **every 6 months**.

Only use hydraulic oil (not motor or brake oil) to top-up.

	Oil viscosity:	30 CST at 40°C
	Total volume:	0.3 l

- A. Fully lower the forks.
- B. Unscrew and remove the oil tank closing screw.
- C. If required, add oil through the syringe (not supplied) until the first leak.
- D. Operate the pump several times to release any air from the hydraulic circuit, then lower the forks completely.
- E. Reassemble the closing screw.

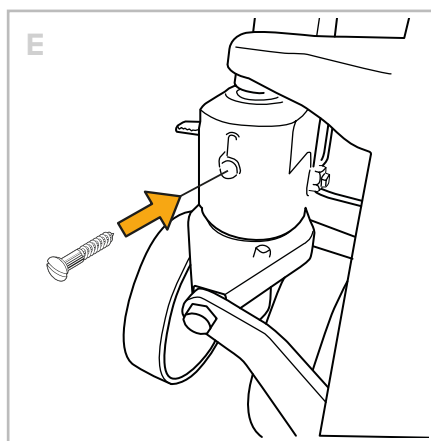
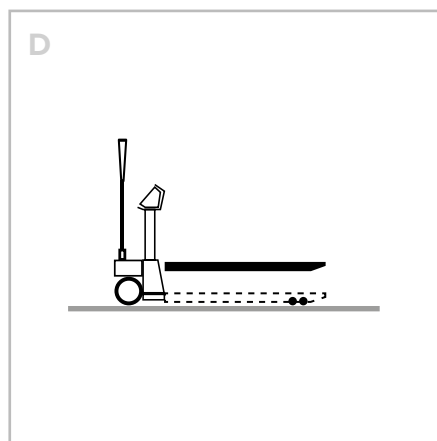
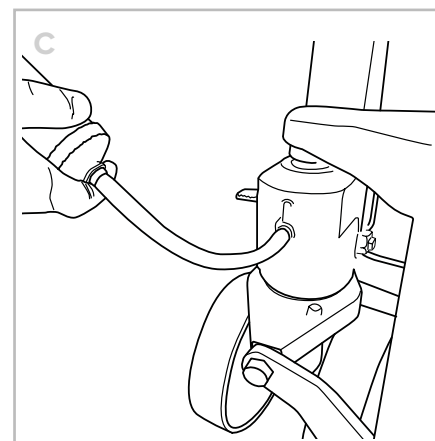
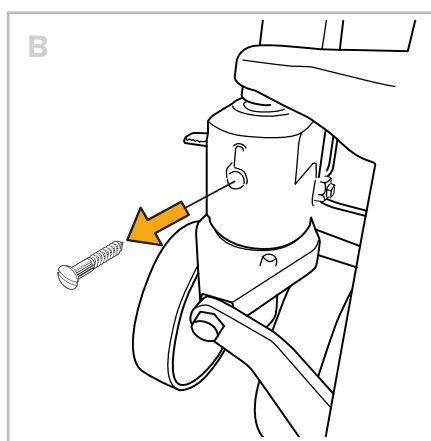
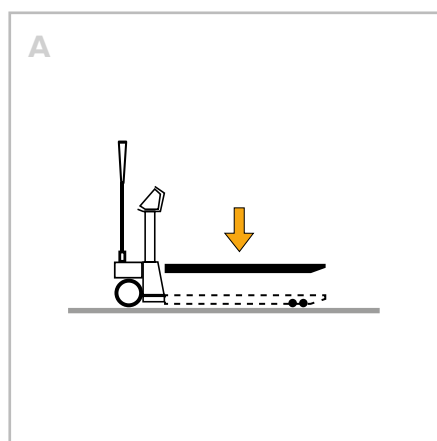

Unscheduled maintenance

For unscheduled maintenance on the machine, contact the Authorised Support Centre.



WARNING!

Unscheduled maintenance and repair of the machine are reserved for qualified, instructed and authorised technicians, depending on the manufacturer or authorised service centre.

These operations require in-depth and specialised knowledge of the machines, of the operations required, of the risks involved and of the correct procedures to operate in safety.

TROUBLESHOOTING CASES

PRINT	The scale does not print	<ul style="list-style-type: none"> • Another printout is already in progress (busy) • Make sure there is a roll in the printer • The printer does not switch on • The weight is unstable (unStAb) • The net or gross weight is negative or insufficient for printing (low) • Underload or overload (_____ or -----) (un.oVEr) • The scale was not unloaded after the last printing (no.0.unS) • You are trying to print a non-approved weight
TOTALISATION	The scale does not accumulate	<ul style="list-style-type: none"> • Make sure there is a roll in the printer • The printer does not switch on • The weight is unstable (unStAb) • The net or gross weight is negative (LdB) • Underload or overload (----- or -----) (un.oVEr) • The scale was not unloaded after the last printing (no.0.unS) • The weight is too low for the weighing operation (LdB) <ul style="list-style-type: none"> - less than 10 divisions for the accumulator modes - less than "Min" for the approved products (shown on the measuring plate)
	The scale has lost the total	<ul style="list-style-type: none"> • Switching off the scale causes the accumulated totals to be lost
TARE	The scale does not tare	<ul style="list-style-type: none"> • The weight is unstable (unStAb) • The gross weight is negative (LdB) • The weight is insufficient • The weight exceeds the maximum capacity • The tare function has been deactivated • In the event of manual tare, the value exceeds the maximum capacity
WEIGHING	The scale does not switch on	<ul style="list-style-type: none"> • Make sure the power cable is connected properly • Connect the battery charger and try again. If the instrument continues to malfunction, contact the dealer.
	The scale switches off suddenly	<ul style="list-style-type: none"> • Automatic switching off active • Low battery • Battery failure • Power supply line failure
	The scale is not reactive	<ul style="list-style-type: none"> • One of the available energy saving modes has been activated • An unsuitable weighing filter has been selected
	The scale display switches off and displays a dot	<ul style="list-style-type: none"> • Stand-by mode is active: press a key to reactivate weighing. • Energy saving mode is active: contact the dealer for further details.
	The scale displays a permanent "ZEro" message	<ul style="list-style-type: none"> • The scale is unable to automatically reset the weight because it exceeds the maximum resettable weight at switch-on. • Unload the scale and try again. If the scale continues to have the same problem even when there is nothing on it, contact the dealer.

	The weight is unstable	<ul style="list-style-type: none">• Check whether the weighing filter is active.• If the support surface is subjected to vibrations from machinery or moving vehicles, move the scale onto another surface and try again.
PIECE COUNTER	The scale does not carry out sampling	<ul style="list-style-type: none">• The weight is unstable (<i>Err . Flat</i>)• The weight is insufficient, add more pieces and try again (<i>Error</i>)

Error messages

MESSAGE	DESCRIPTION	SOLUTION
<i>buSy</i>	Another printout is already in progress	Wait for the printout in progress to be finished and try again.
<i>unStAb</i>	The weight is unstable	Check the weighing filter. If the support surface is subjected to vibrations from machinery or moving vehicles, move the scale onto another surface and try again.
<i>LoH</i>	The net or gross weight is negative or insufficient for printing	Add weight and try again.
<i>undEr</i>	Underload	Load the scale and restore a valid weight condition. If the problem persists, contact customer service.
<i>oVEr</i>	Overload	Unload the scale and restore a valid weight condition. If the problem persists, contact customer service.
<i>no.O.unS</i>	The scale was not unloaded after the last printing	Completely unload the scale, making sure →0← lights up. Load the weight and try again.
<i>Err.NoSt</i>	The weight is unstable	Wait for stability (the ~ light) and try again.
<i>Error</i>	In piece counting mode, the weight is insufficient for proper sampling.	Add more pieces and try again.
<i>t iLt</i>	Angle error.	Move the pallet truck to a flat surface and try again.



HEAD OFFICE

Via Della Fisica, 20
41042 Spezzano di Fiorano, Modena - Italy
Tel. +39 0536 843418 - Fax +39 0536 843521

SERVICE ASSISTANCE

Via Dell'Elettronica, 15
41042 Spezzano di Fiorano, Modena - Italy
Tel. +39 0536 921784 - Fax +39 0536 926654

www.diniargeo.com

Authorised service centre stamp

