

SURVIVOR Weigh Modules

TABLE OF CONTENTS

SURVIVOR Paramounts® HE	32
<i>Medium-capacity Weigh Module Systems</i>	
RL1700 HE	33
<i>Light- to Medium-capacity Weigh Modules</i>	
RL1600 HE Series	34
<i>Medium-capacity with RL75016WHE Load Cells</i>	
RL1855 HE-HS	35
<i>Medium-capacity Weigh Modules</i>	
RL2100 HE	36
<i>Heavy-capacity Weigh Modules</i>	

Product names, logos, brands and other trademarks featured or referred to within this publication are the property of their respective trademark holders.

SURVIVOR Paramounts® HE

Medium-capacity Weigh Module Systems

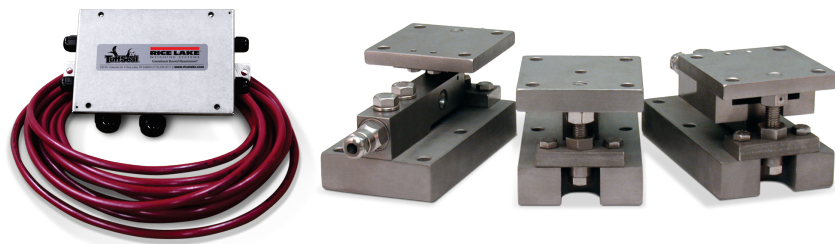

Picture is a representation of actual product.

Complete Kit Includes

- One fixed-pin module, one side-stop module, and one or two free-sliding assemblies. Each module is complete with a Flintec SB4 stainless steel hermetically sealed load cell.
- One JB4SS NEMA Type 4X stainless steel signal trim junction box
- 25 ft of our hostile environment EL147HE SURVIVOR load cell cable

Standard Features

- All stainless steel construction
- Bolt-in-place design; module bolts directly to tank leg without requiring additional load buttons or mounting plates
- Load cell outputs are mV/V/ohm calibrated to minimize maintenance costs
- Unique design allows for thermal expansion/contraction
- Low-profile, self-checking design
- Jacking screw allows empty vessel to be lifted clear of load cell for maintenance
- Unique patented blind load hole technology minimizes unwanted side and eccentric loading
- Vessel is free to slide laterally on PTFE-coated surfaces

Applications

- Medium-capacity blenders and tanks
- Batching/blending
- Pharmaceutical processing
- Food processing
- Petroleum refining and batching

Load Cell Approvals



Order Information

Load Rating (Per Module)	Part #	Price
NTEP Certified/OIML C3 3-Module Kit		
5 kN	29883	\$4,314.00
10 kN	29884	\$4,314.00
23 kN	29885	\$4,314.00
50 kN	29886	\$5,835.00
NTEP Certified/OIML C3 4-Module Kit		
5 kN	29879	\$5,734.00
10 kN	29880	\$5,734.00
23 kN	29881	\$5,734.00
50 kN	29882	\$7,378.00
Non-NTEP Certified 3-Module Kit		
5 kN	17991	\$4,200.00
10 kN	17992	\$4,200.00
23 kN	17993	\$4,200.00
50 kN	17994	\$5,460.00
100 kN	17995	\$6,220.00
Non-NTEP Certified 4-Module Kit		
5 kN	17998	\$5,480.00
10 kN	17999	\$5,480.00
23 kN	18000	\$5,480.00
50 kN	18001	\$6,906.00
100 kN	18002	\$8,644.00
*Conduit adapter, 1/2-14 NPT	17703	\$50.00

*Must be factory installed

Dimensions

Rated Capacity	C	D	H	H1	*H2	**H2	H3	L	L1	L2	L3	L4	W	W1
kN/in														
5 to 23	0.44	0.44	3.58	1.25	0.50	0.75	3.06	7.51	3.00	4.00	3.00	0.50	4.00	3.00
50	0.56	0.56	4.66	1.50	0.62	1.00	4.09	9.19	3.87	5.00	3.87	0.56	5.00	3.87
100	0.69	0.69	6.41	2.00	0.75	1.25	5.73	11.46	4.75	6.00	4.75	0.69	6.00	4.75

*Side stop and free sliding units **Fixed pin units

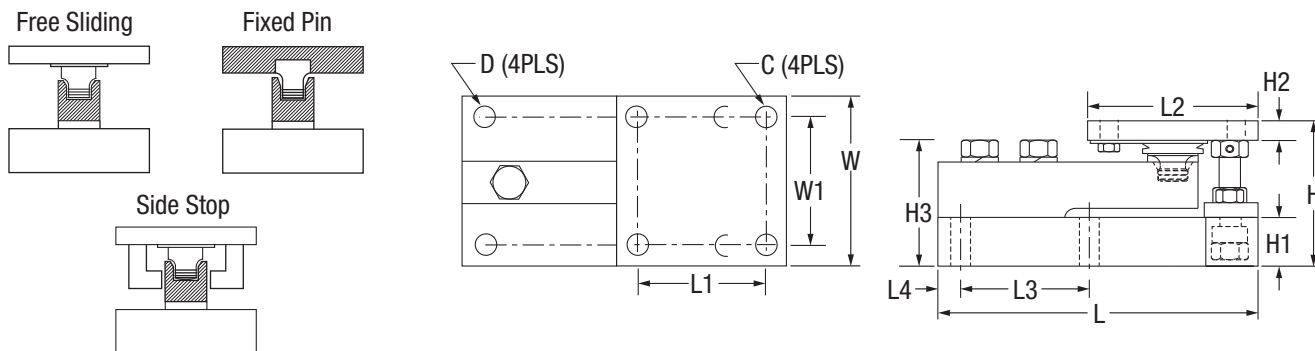

SURVIVOR®
WEIGH MODULES

RL1700 HE

Light- to Medium-capacity Weigh Modules

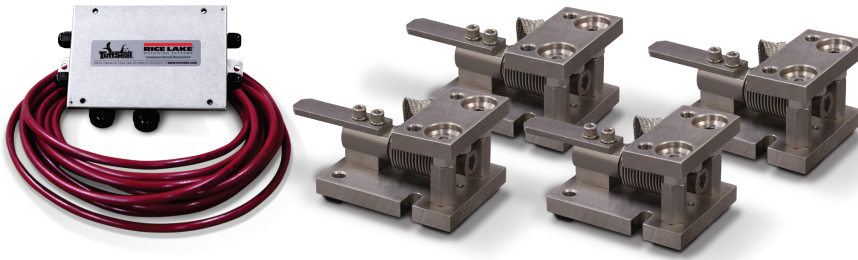

Picture is a representation of actual product.

Order Information

Load Rating (Per Module)	Part #	Price
Single Module (Includes Load Cell)		
5 kg	32687	\$1,000.00
10 kg	32688	\$1,000.00
20 kg	32689	\$1,000.00
50 kg	32690	\$1,000.00
100 kg	32691	\$1,000.00
200 kg	32692	\$1,000.00
250 kg	32693	\$1,000.00
500 kg	32974	\$1,225.00
1,000 kg	32973	\$1,225.00
2,000 kg	32972	\$1,225.00
5,000 kg	32971	\$1,495.00
3-Module Kit		
5 kg	32920	\$3,215.00
10 kg	32921	\$3,215.00
20 kg	32922	\$3,215.00
50 kg	32923	\$3,215.00
100 kg	32924	\$3,215.00
200 kg	32925	\$3,215.00
250 kg	32926	\$3,215.00
500 kg	32980	\$3,875.00
1,000 kg	32981	\$3,875.00
2,000 kg	32982	\$3,875.00
5,000 kg	32983	\$4,785.00
4-Module Kit		
5 kg	32927	\$4,250.00
10 kg	32928	\$4,250.00
20 kg	32929	\$4,250.00
50 kg	32930	\$4,250.00
100 kg	32931	\$4,250.00
200 kg	32932	\$4,250.00
250 kg	32933	\$4,250.00
500 kg	32984	\$5,105.00
1,000 kg	32985	\$5,105.00
2,000 kg	32986	\$5,105.00
5,000 kg	32987	\$5,985.00

Dimensions

Rated Capacity	C	B	*H1	**H2	L	L1	L2	L3	L4	L5	W	W1	W2	W3
kg/mm														
5 to 250	13.1	1/2-20 UNF	80.0	86.1	131.8	63.8	76.0	42.0	56.0	14.1	101.4	70.0	15.5	25.4
500 to 2,000	13.1	5/8-18 UNF	101.6	109.4	165.1	71.2	129.5	15.5	75.5	60.0	110.0	70.0	20.0	31.8
5,000	19.8	3/4-10 UNC	135.0	143.0	215.0	81.0	161.0	20.0	90.0	70.0	150.0	90.0	30.0	40.0

* In weighing position ** In jacked-up position for load cell shipping or removal

Complete Kit Includes

- Three or four RL1700 HE stainless steel compression mounts with NTEP Certified RL9018SS (5 to 250 kg) or RLHTO (500 to 5,000 kg) stainless steel, hermetically sealed single-ended beam load cells
- One JB4SS NEMA Type 4X stainless steel signal-trim junction box
- 25 ft of our hostile environment EL147HE SURVIVOR load cell cable

Standard Features

- Capacities (per module) 5 kg to 5,000 kg
- All stainless steel, weldless construction retains less residue and allows fast, thorough cleaning
- Bolt-in-place design; module bolts directly to tank leg without requiring additional load buttons or mounting plates
- Self-checking with lift-off/tip-over protection and jacking/shipping bolts
- Load cell is isolated from overload in all directions

Applications

- Multi-ingredient micro-batching
- Meat and poultry processing
- Batching/blending
- Dye/ink blending

Load Cell Approvals

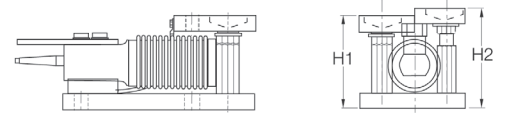

5 kg - 250 kg capacities

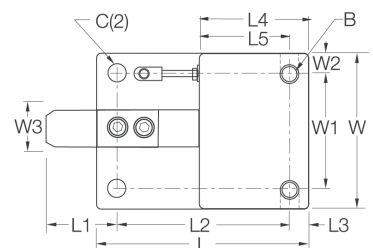
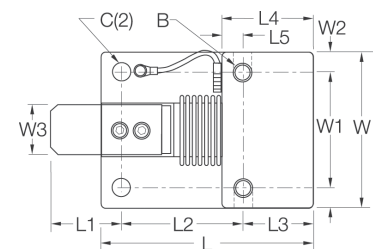

500 kg - 5000 kg capacities

SURVIVOR® WEIGH MODULES

RL1600 HE Series

Medium-capacity with RL75016WHE Load Cells

Discontinued

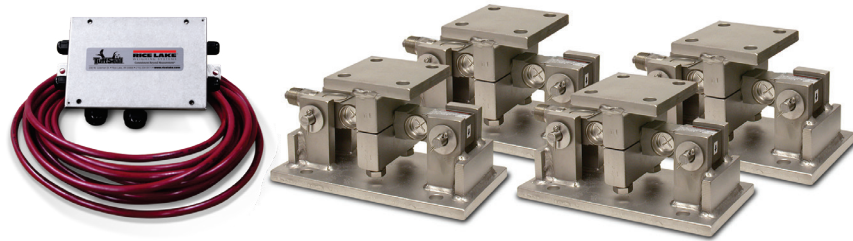

Picture is a representation of actual product.

Complete Kit Includes

- Three or four RL1600 HE stainless steel compression mounts with RL75016WHE stainless steel, hermetically sealed double-ended shear beam load cells
- One JB4SS NEMA Type 4X stainless steel signal trim junction box
- 25 ft of our hostile environment EL147HE SURVIVOR load cell cable

Standard Features

- All stainless steel construction
- Self-checking, easy-to-use design allows module to be bolted directly to tank leg without requiring additional mounting plates or load buttons
- Center loaded

Applications

- Medium-capacity tanks, bins and hoppers
- Bulk material management
- Ingredient batching, mixing and blending

Load Cell Approvals



SURVIVOR®
WEIGH MODULES

Order Information

Load Rating (Per Module)	Part #	Price
Single Mount Does Not Include Load Cells		
1,000 to 5,000 lb	17813	\$685.00
10,000 to 25,000 lb	17815	\$1,345.00
3-Module Kit		
1,000 lb	46723	\$4,500.00
1,500 lb	119673	\$4,500.00
2,000 lb	119675	\$4,500.00
2,500 lb	46724	\$4,500.00
5,000 lb	46725	\$4,500.00
10,000 lb	46726	\$6,725.00
15,000 lb	46727	\$6,725.00
20,000 lb	84664	\$6,725.00
25,000 lb	46728	\$6,725.00
4-Module Kit		
1,000 lb	46729	\$5,865.00
1,500 lb	119674	\$5,865.00
2,000 lb	119676	\$5,865.00
2,500 lb	46730	\$5,865.00
5,000 lb	46731	\$5,865.00
10,000 lb	46732	\$8,800.00
15,000 lb	46733	\$8,800.00
20,000 lb	84665	\$8,800.00
25,000 lb	46734	\$8,800.00
Dummy Load Cells (Mild Steel)		
1,000 to 5,000 lb	18236	\$26.00
10,000 to 25,000 lb	18237	\$42.00

Shims*

Part #	Price
1,000 to 5,000 lb	
0.0625	150852 \$7.00
0.125	150853 \$12.00
0.250	150854 \$18.00
10,000 to 25,000 lb	
0.0625	150855 \$19.00
0.125	150856 \$30.00
0.250	150857 \$65.00

*Shims match the top plate

Dimensions

Rated Capacity	C	H	H1	H2	L	L1	L2	L3	T	W	W1	W2	W3
lb/in													
1,000 to 5,000	0.56	5.00	0.50	0.50	9.25	2.75	4.00	6.25	1/2-13 UNC	5.00	3.75	2.75	4.00
10,000 to 25,000	0.78	7.87	0.75	0.75	12.00	6.00	8.00	7.50	3/4-10 UNC	8.00	6.00	6.00	8.00

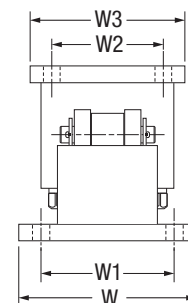
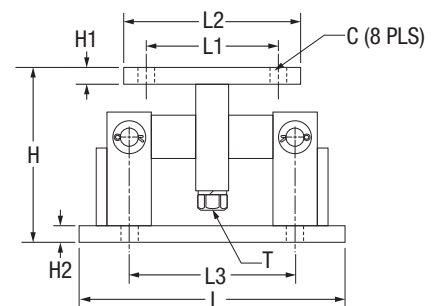

RL1855 HE-HS

Medium-capacity Weigh Modules



Picture is a representation of actual product.

Complete Kit Includes

- Three or four RL1855 HE stainless steel mounts with RL32218S-HE NTEP Certified hermetically sealed stainless steel load cells
- One JB4SS NEMA Type 4X stainless steel signal trim junction box
- 25 ft of hostile environment EL147HE SURVIVOR load cell cable

Standard Features

- NTEP Certified load cells, 5,000 d Class III multiple load cell
- All stainless steel construction
- Self-checking design with lift off/tip off protection

Applications

- Medium-capacity hoppers, bins and tanks
- Batching/blending

Load Cell Approvals



Order Information

Load Rating (Per Module)	Part #	Price
Single Modules (Includes Load Cell)		
1,000 lb	170857	\$1,065.00
2,500 lb	170858	\$1,065.00
4,000 lb	170859	\$1,065.00
5,000 lb	170860	\$1,150.00
10,000 lb	170861	\$1,150.00
3-Module Kit		
1,000 lb	170862	\$3,354.00
2,500 lb	170863	\$3,354.00
4,000 lb	170864	\$3,354.00
5,000 lb	170865	\$3,615.00
10,000 lb	170866	\$3,615.00
4-Module Kit		
1,000 lb	170867	\$4,360.00
2,500 lb	170868	\$4,360.00
4,000 lb	170869	\$4,360.00
5,000 lb	170870	\$4,765.00
10,000 lb	170871	\$4,765.00

Dimensions

Rated Capacity C	C	H min/ max	H1	L	L1	L2	L3	L4	L5	L6	L7	W	W1	W2
lb/in														
1,000 to 4,000	0.62	5.25/5.56	0.50	6.00	2.00	1.00	3.00	2.00	0.68	1.94	4.00	5.00	4.00	2.00
5,000 to 10,000	0.62	6.12/6.62	0.50	7.75	3.00	1.50	3.75	2.00	1.03	2.97	4.00	5.00	4.00	2.00

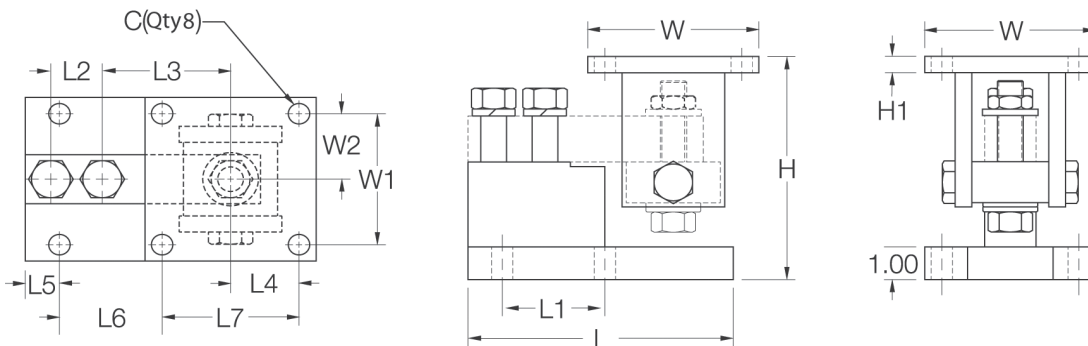

**SURVIVOR®
WEIGH MODULES**

RL2100 HE

Heavy-capacity Weigh Modules

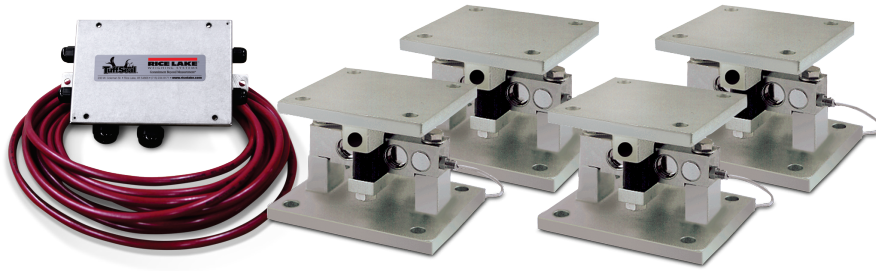

Picture is a representation of actual product.

Complete Kit Includes

- Three or four RL2100 HE stainless steel compression mounts with NTEP Certified RL75060S or RL75058S-LP stainless steel, welded seal double-ended beam load cells
- One JB4SS NEMA Type 4X stainless steel signal-trim junction box
- 25 ft of our hostile environment EL147HE SURVIVOR load cell cable

Standard Features

- NTEP Certified load cells, 5,000 d, Class III/10,000 d, Class III multiple cell
- All stainless steel construction
- Bolt-in-place design; module bolts directly to tank leg without requiring additional load buttons or mounting plates
- Self-checking design with lift-off/tip-over protection

Applications

- Heavy-capacity tanks, blenders, reactors and bulk inventory management
- Petroleum refining process control
- Blending/batching

Load Cell Approvals



SURVIVOR®
WEIGH MODULES

Order Information

Load Rating (Per Module)	Part #	Price
Single Module (Includes Load Cell)		
20,000 lb	32951	\$1,822.00
25,000 lb	65541	\$1,785.00
35,000 lb	32952	\$2,860.00
50,000 lb	32953	\$2,860.00
60,000 lb	32954	\$2,860.00
75,000 lb	32955	\$2,860.00
100,000 lb	32956	\$4,895.00
3-Module Kit		
20,000 lb	32970	\$5,608.00
25,000 lb	65984	\$5,608.00
35,000 lb	32969	\$8,861.00
50,000 lb	32968	\$8,861.00
60,000 lb	32967	\$8,861.00
75,000 lb	32966	\$8,861.00
100,000 lb	32965	\$14,583.00
4-Module Kit		
20,000 lb	32964	\$7,404.00
25,000 lb	65983	\$7,404.00
35,000 lb	32963	\$11,382.00
50,000 lb	32962	\$11,382.00
60,000 lb	32961	\$11,382.00
75,000 lb	32960	\$11,382.00
100,000 lb	32959	\$19,362.00

Dimensions

Rated Capacity	C	H	H1	H2	L	L1	L2	L3	W	W1	W2	W3
lb/in												
20,000 to 25,000	0.78	6.85	0.75	0.75	10.00	6.00	8.00	7.50	8.00	6.00	6.00	8.00
35,000 to 100,000	1.13	9.42	1.00	1.00	14.00	6.50	9.00	11.50	10.00	7.50	6.50	9.00

