

iDimension® Software Suite

Web Server Integration Software

Software Manual

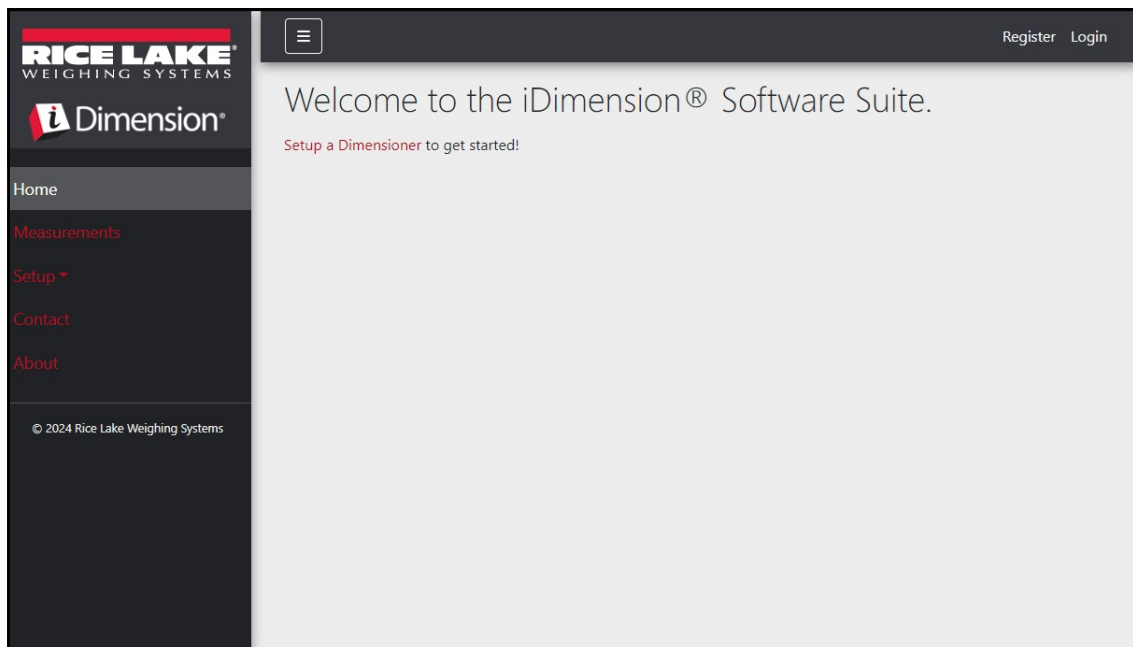

© Rice Lake Weighing Systems. All rights reserved.

Rice Lake Weighing Systems® is a registered trademark of
Rice Lake Weighing Systems.

All other brand or product names within this publication are trademarks or
registered trademarks of their respective companies.

All information contained within this publication is, to the best of our knowledge, complete and
accurate at the time of publication. Rice Lake Weighing Systems reserves the right to make
changes to the technology, features, specifications and design of the equipment without notice.

The most current version of this publication, software, firmware and all other product
updates can be found on our website:

www.ricelake.com

Revision History

This section tracks and describes the current and previous manual revisions for awareness of major updates and when the updates took place.

Revision	Date	Description
A	May 25, 2021	Initial manual release with the launch of the product; software version 1.0
B	August 26, 2024	Updates include new features from multiple software version releases; software version 2.27
C	September 17, 2024	Updates include new features from multiple software version releases; software version 2.28
D	December 18, 2024	Updated system configuration parameters and indicator list; software version 2.29
E	February 17, 2025	Updates include new features from multiple software version releases; software version 2.31

Table i. Revision Letter History



Technical training seminars are available through Rice Lake Weighing Systems. Course descriptions and dates can be viewed at www.ricelake.com/training or obtained by calling 715-234-9171 and asking for the training department.

Contents

1.0	Introduction	7
1.1	System Requirements	7
1.2	Software Updates	7
2.0	Installation	8
2.1	Software Installation	8
2.1.1	Windows Firewall TCP Port Configuration	10
2.2	(Optional) Configuring IIS with Reverse Proxy	15
2.3	System Configuration	20
2.3.1	System Configuration File Preparation	20
2.3.2	System Configuration File Parameters	20
2.4	Initial Browser Navigation	26
2.4.1	Export the Certificate	26
3.0	Login, User Management and Configuration	35
3.1	Login	35
3.1.1	Access iDimension SS	35
3.1.2	Initial Login	36
3.2	Main Page	37
3.3	User Configuration	38
3.3.1	User Registration	38
3.3.2	Reset Password	39
3.3.3	User Management	40
3.4	Configuration	42
3.4.1	Dimensioner Setup and Configuration	42
3.4.2	Scale Setup and Configuration	49
3.4.3	Forklift Setup and Configuration	53
3.5	Global Setup and Configuration	58
3.5.1	Access Setup items:	58
3.5.2	Image Annotation	58
3.5.3	Image Composition	60
3.5.4	User Defined Fields	61
3.5.5	Primary and Secondary FTP Upload Configuration	61
3.5.6	SMB File Copy (Windows Only)	63
3.5.7	SFTP Upload (SSH File Transfer Protocol)	65
3.5.8	REST API Configuration	66
3.5.9	Label Printing Configuration	67
3.5.10	Capture Complete View	68
3.5.11	System Notifications	69
3.5.12	Volumetric Conversion	70
3.5.13	Remote I/O	71
3.5.14	Shipping Method Analyzer	72
3.5.15	Scanner Trigger Service Configuration	73
3.5.16	Scale Settings	73
3.5.17	Freight Size Configuration	74
3.6	About	74
3.6.1	HTTP REST	74
4.0	Operation	75



Rice Lake continually offers web-based video training on a growing selection of product-related topics at no cost. Visit www.ricelake.com/webinars

4.1 Capture Measurement Data 75

4.2 Manage Measurement Data 77

 4.2.1 View a Measurement 78

 4.2.2 Delete a Measurement 78

 4.2.3 Export Measurements 79

5.0 Administration 80

 5.1 View Failed Scan Data 80

 5.1.1 Search for Failed Scans 80

 5.1.2 View A Failed Scan 80

 5.2 Access Log Files 81

 5.3 Access to System Configuration 82

 5.4 Dimensioner Testing 85

 5.5 Computer to Computer Communications 87

6.0 Appendix 88

 6.1 Filename Template Tokens/Printer Label Tokens 88

 6.2 Barcode Scanner Service 89

 6.3 Error Codes 90

 6.4 RTD Desktop Display 92

 6.5 iDim SS Images 95



Technical training seminars are available through Rice Lake Weighing Systems. Course descriptions and dates can be viewed at www.ricelake.com/training or obtained by calling 715-234-9171 and asking for the training department.



Rice Lake continually offers web-based video training on a growing selection of product-related topics at no cost. Visit www.ricelake.com/webinars

1.0 Introduction

This manual provides an overview of the iDimension® Software Suite installation and configuration procedures.



Manuals are available from Rice Lake Weighing Systems at www.ricelake.com/manuals

Warranty information is available at www.ricelake.com/warranties

1.1 System Requirements

- Windows 10 build 1607 or newer (64 bit only)
- 2.0 GHz processor or faster
- 250 MB HD Space needed for install
- 8 GB RAM or greater
- Ethernet TCP/IP connection to dimensioning devices and optional digital weight indicator(s)
- A supported web browser (Apple® Safari®, Google® Chrome®, Microsoft® Edge®, Mozilla® Firefox®)

1.2 Software Updates

Software updates are provided from Rice Lake Weighing Systems through an FTP file transfer. Use the following procedure when a new version of software is available:

1. Uninstall original software. Ensure there are no existing *.exe files stored on the computer for the iDimension SS.
2. Install the latest software version. Ensure other iDimension programs like iDimension SS RTD and iDimension SS Forklift are compatible with the new version.



NOTE: The About dialog boxes in iDimension SS RTD and iDimension SS Forklift list the minimum required iDimension SS version.

3. All settings will be restored, except application modifications made during installation.
See C:\Program Files\Rice Lake Weighing Systems\iDimSS and open appsetting.json as an administrator.

2.0 Installation

This section provides installation procedures for the iDimension Software Suite (iDimension SS).



NOTE: The procedures in this chapter are performed in Windows 11 (Version 10.0.22621 Build 22621). Other Windows versions may vary.

2.1 Software Installation



NOTE: If an error occurs during the installation or database setup, the information is written to a file named `installlog.txt` located in the root folder of the `C:\` drive.

1. Download iDimension SS software and unzip the file if necessary.



NOTE: Typically a download link is supplied with the purchase of software.

2. Launch `X.XXiDimSS.Installer.exe` (where `X.XX` is the version number).
3. Read the Rice Lake Weighing Systems License Agreement. Enable the check box below the agreement if the terms are acceptable.

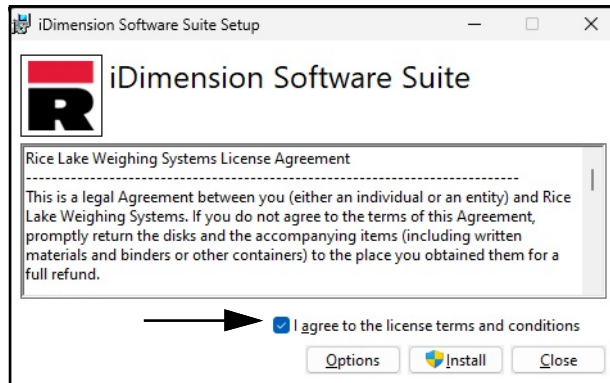

Figure 2-1. iDimension SS Installation Window

4. (Optional) Perform the following to change the installation location:
 - Select **Options**, then **Browse** to install iDimension SS in a user specified file location.
 - Select OK to return to the previous window.

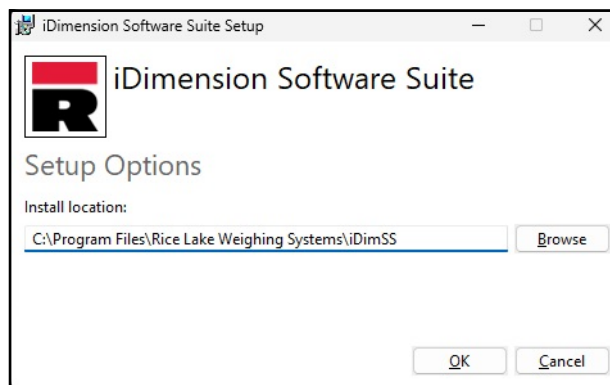

Figure 2-2. iDimension SS Installation Options

5. Select **Install**.

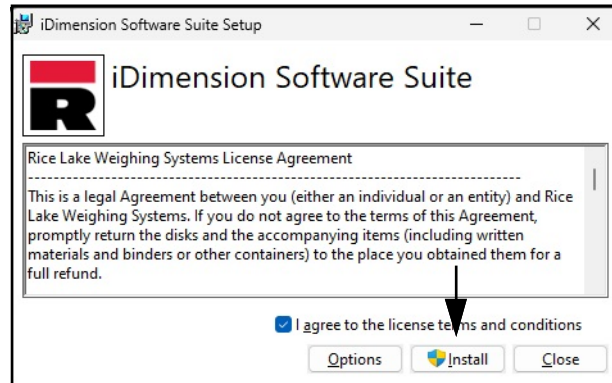

Figure 2-3. iDimension SS Installation Window

6. The installation progress displays.

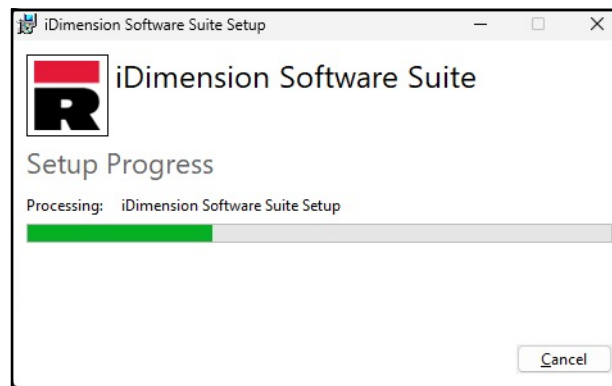

Figure 2-4. iDimension SS Installation Options

7. The Installation Successfully Completed window displays, select **Close**. iDimension SS is successfully installed.

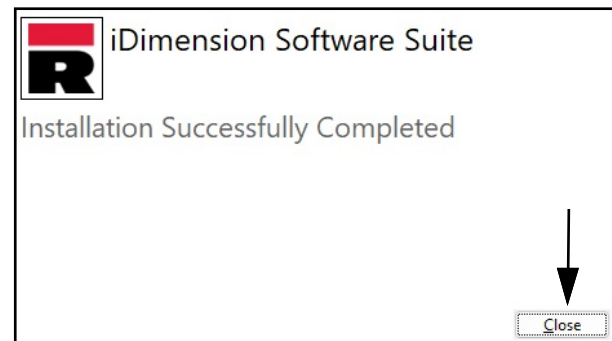

Figure 2-5. iDimension SS Installation Window



NOTE: After activation, the executable file distributes the application and all required prerequisites on the system. If an error occurs during the installation or database setup, the information is written to the `installlog.txt` file located in the root folder of the `C:\` drive.

2.1.1 Windows Firewall TCP Port Configuration

The host computer's firewall must be configured to allow inbound and outbound traffic for specific network ports in order for devices to communicate with iDimension SS. The following are TCP ports that may be used during firewall configuration:

- 5000: HTTP Access
- 5001: HTTPS Access
- 5002: Cubiscan® Protocol Emulation
- 6001: Mettler® Protocol Emulation
- 7001: Scanner/Indicator input



NOTE: This procedure describes configuring Inbound and Outbound rules in the Windows Defender® firewall. Other firewall configurations may vary. If the system has a firewall that is included as part of an Anti-Virus package, refer to that software's documentation for port configuration.

1. Open the Control Panel.
2. Select **Windows Defender Firewall**.

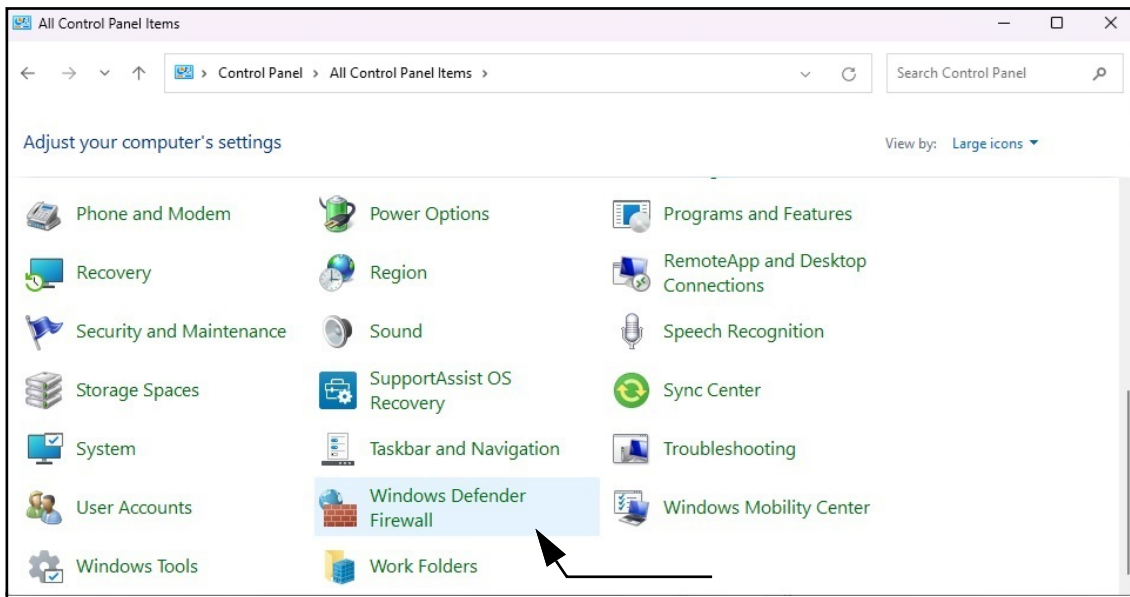

Figure 2-6. Windows Control Panel with Defender Firewall Identified

3. Windows Defender Firewall settings display.
4. Select **Advanced settings**.



Figure 2-7. Windows Defender Firewall with Advanced Settings Identified

5. Windows Defender Firewall with Advanced Security displays.
6. Right-click **Inbound Rules** and then select **New Rule**.

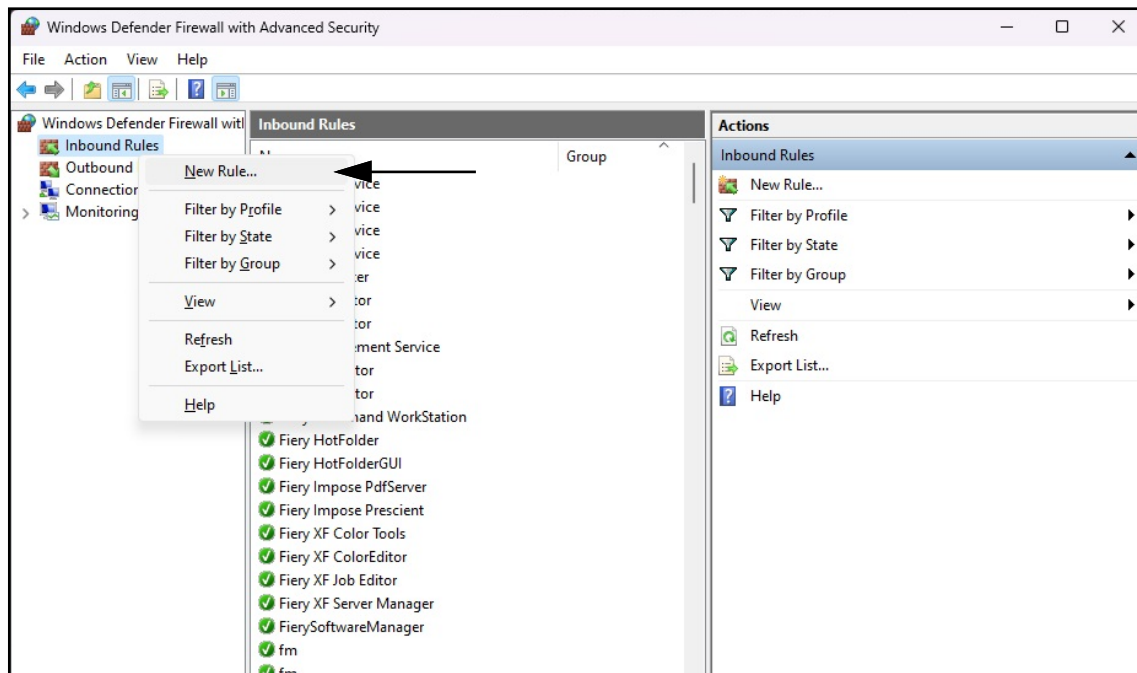

Figure 2-8. Windows Defender Firewall with Advanced Security

7. New Rule Wizard opens with Rule Type parameters displayed.
8. Select **Port**.
9. Select **Next**.

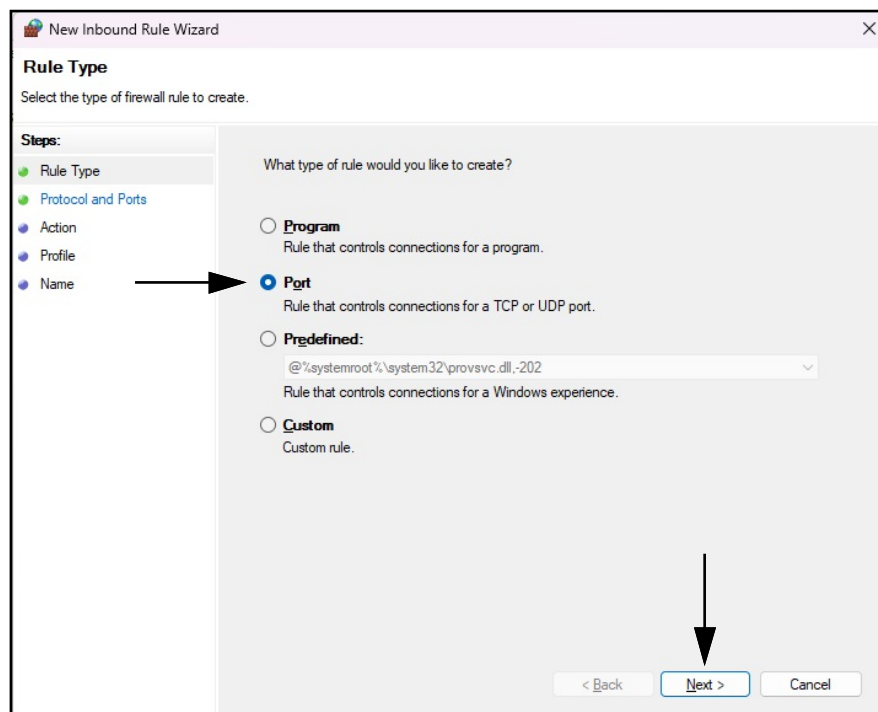

Figure 2-9. Rule Type Parameters with Port Identified

10. Protocol and Ports parameters display.
11. Select **TCP**.
12. Enter the required port numbers in the specific local ports field (for example 5000, 5001, 5002, 6001, 7001).
13. Select **Next**.

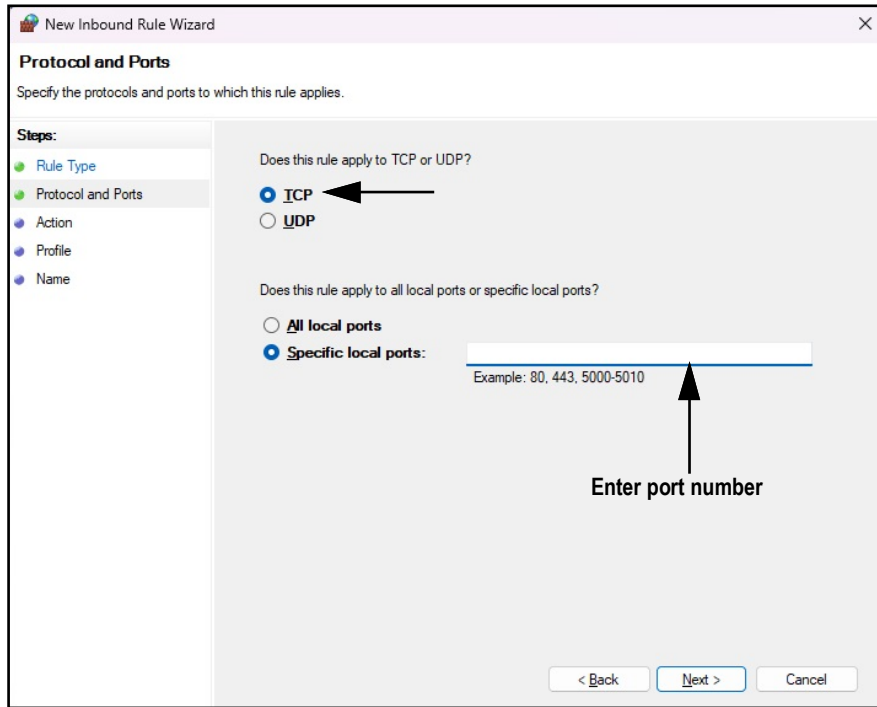

Figure 2-10. Protocol and Ports Parameters

14. Action parameters display.
15. Select **Allow the connection**.
16. Select **Next**.

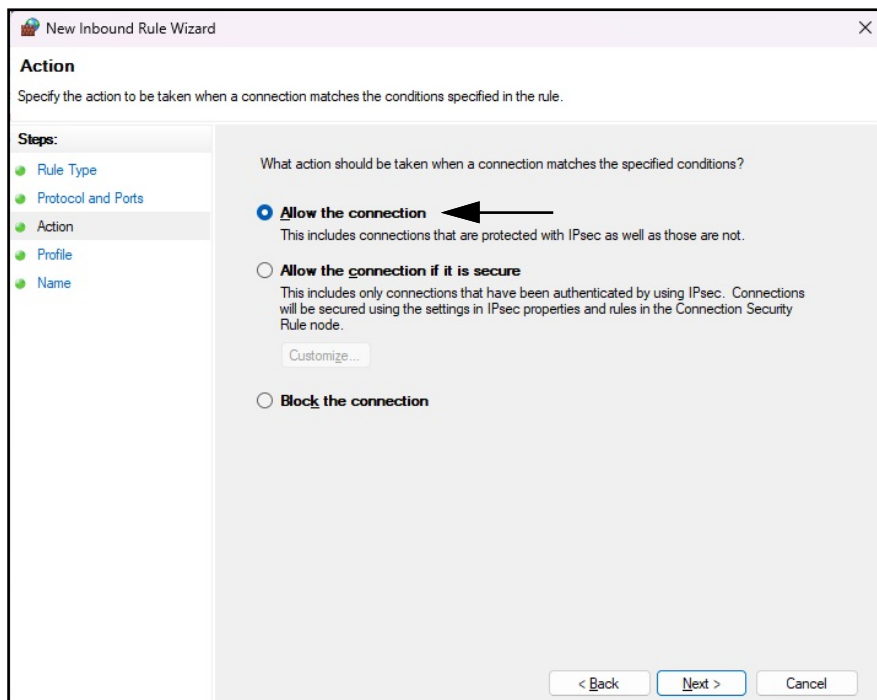

Figure 2-11. Action Parameters with Allow the Connection Identified

17. Profile parameters display.
18. Enable parameters as required (typically all).
19. Select **Next**.

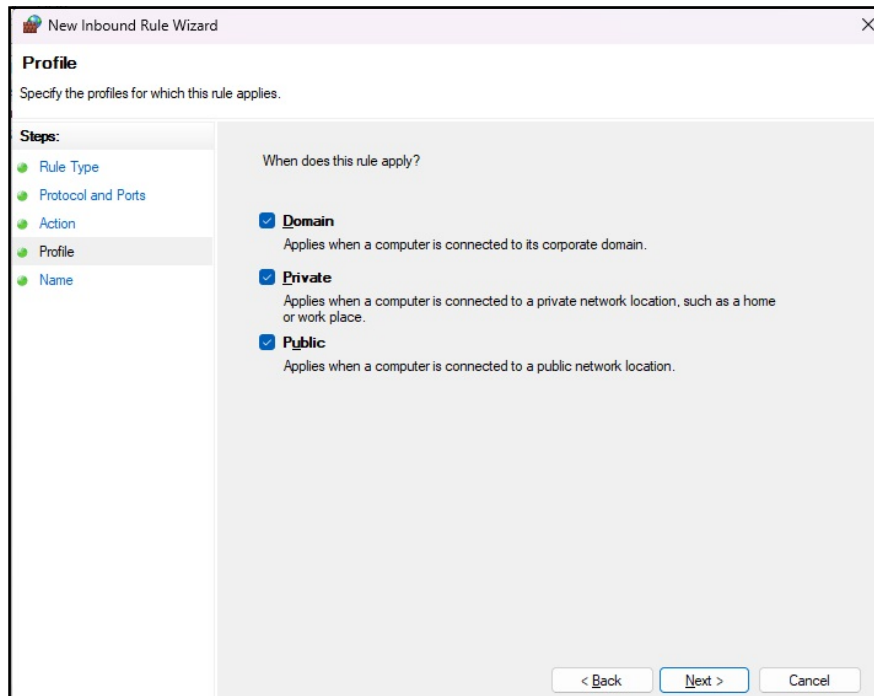

Figure 2-12. Profile Parameters

20. Name parameters display.
21. Enter a name for the rule.
22. (Optional) If desired, enter a description for the rule.
23. Select **Finish**.

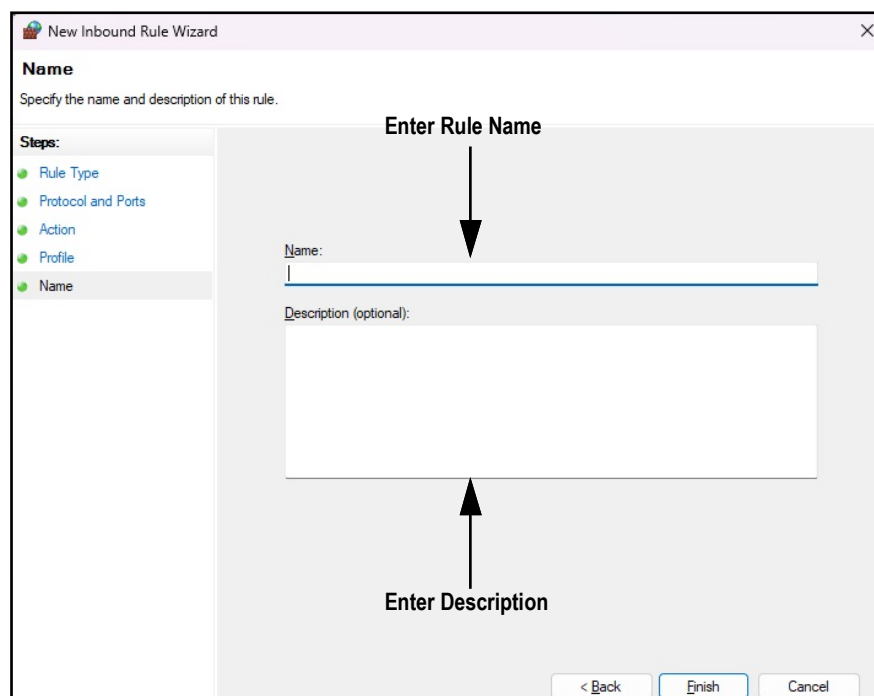

Figure 2-13. Name Parameters

24. The new Rule is added to the top of the Inbound Rules list.

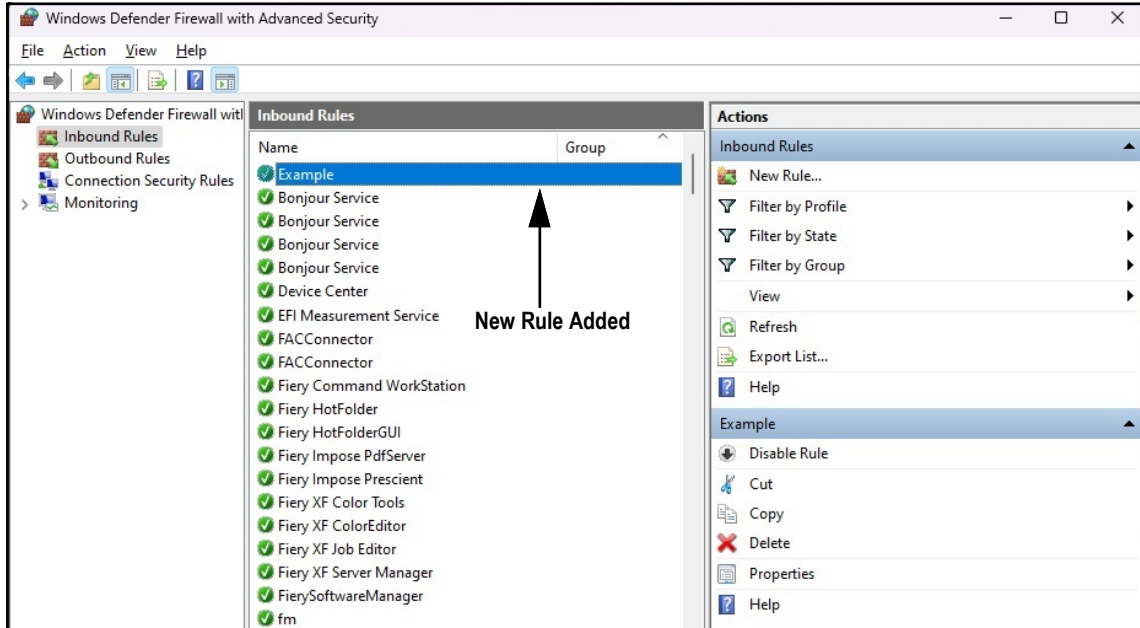

Figure 2-14. New Rule added to Windows Defender Firewall Advanced Settings

25. Right-click **Outbound Rules** and then select **New Rule**.

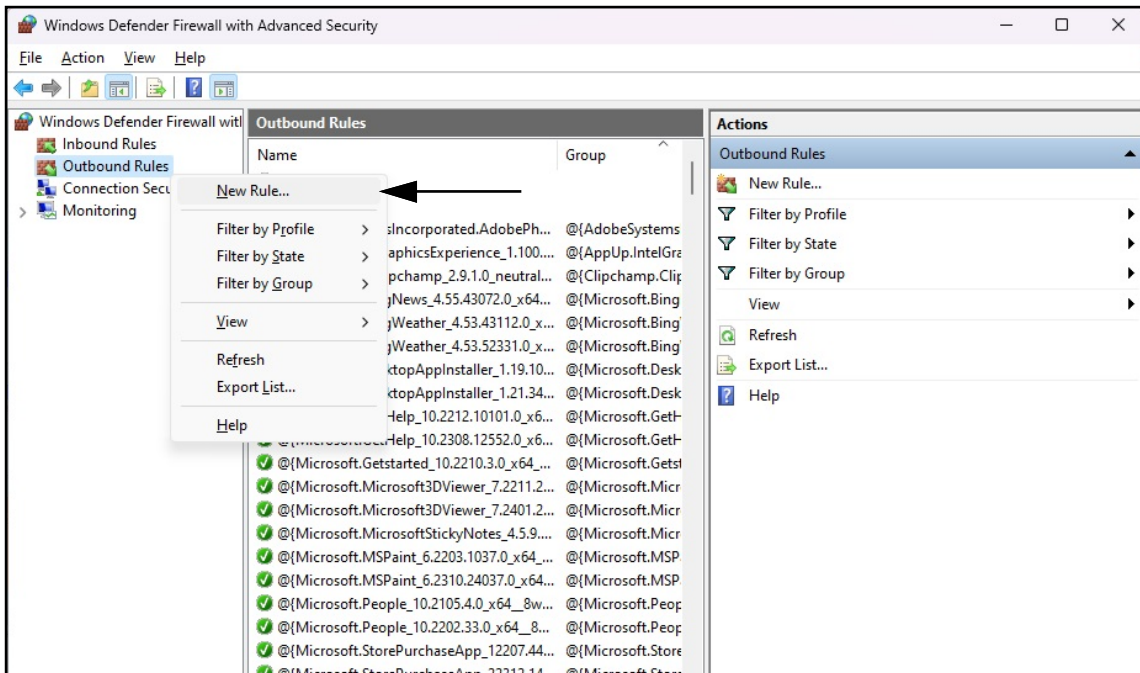

Figure 2-15. Windows Defender Firewall with Advanced Security

26. Repeat Steps [Step 7](#) through [Step 24](#) to create an outbound rule.

27. (Optional) Repeat the procedure for additional required ports.

2.2 (Optional) Configuring IIS with Reverse Proxy

Configuring Microsoft Internet Information Services as a reverse proxy is only necessary if either the application will be available on the Internet, or if the user desires HTTPS encryption/security between the server and the client browsers using a standard SSL security certificate rather than the included self-signed certificate.

After iDimension SS software is installed, Microsoft Internet Information Services (IIS) can be optionally installed to act as a web host for iDimension SS. For information on installing Windows features and software, consult Windows help.

IMPORTANT: Installation of IIS and the Reverse Proxy is optional and only required if the instance of iDimension SS will be accessible from the internet.

NOTE: An SSL certificate to enable HTTPS is not provided. The customer must supply a SSL certificate if they intend to make iDimension SS public or if their IT policy requires support for HTTPS.

- To install required or configure Windows system components, perform one of the following:

NOTE: Step A uses an optional script file to set the Windows system components opposed to the manual process outlined in Step B.

- Run the `idimss-dism-win10.cmd` script (from the installation package) as an Administrator.
- In Windows Search enter “Turn Windows features on or off” and select the **Option** that displays.

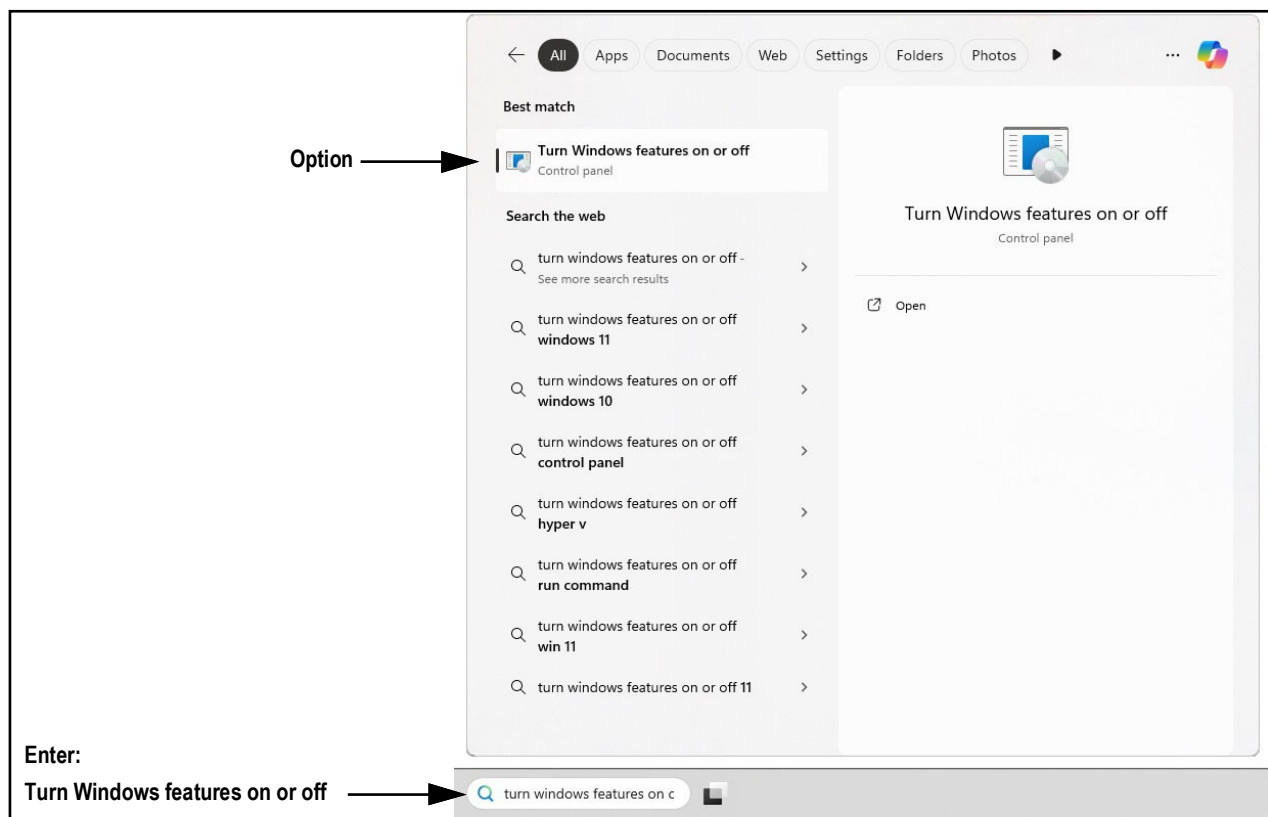

Figure 2-16. Search for Turn Windows Features On or Off

- Windows Features window displays (see [Figure 2-17 on page 16](#)).

B.2 Expand **Internet Information Services** tree and enable check boxes as displayed in [Figure 2-17](#).

B.3 Select **OK**.

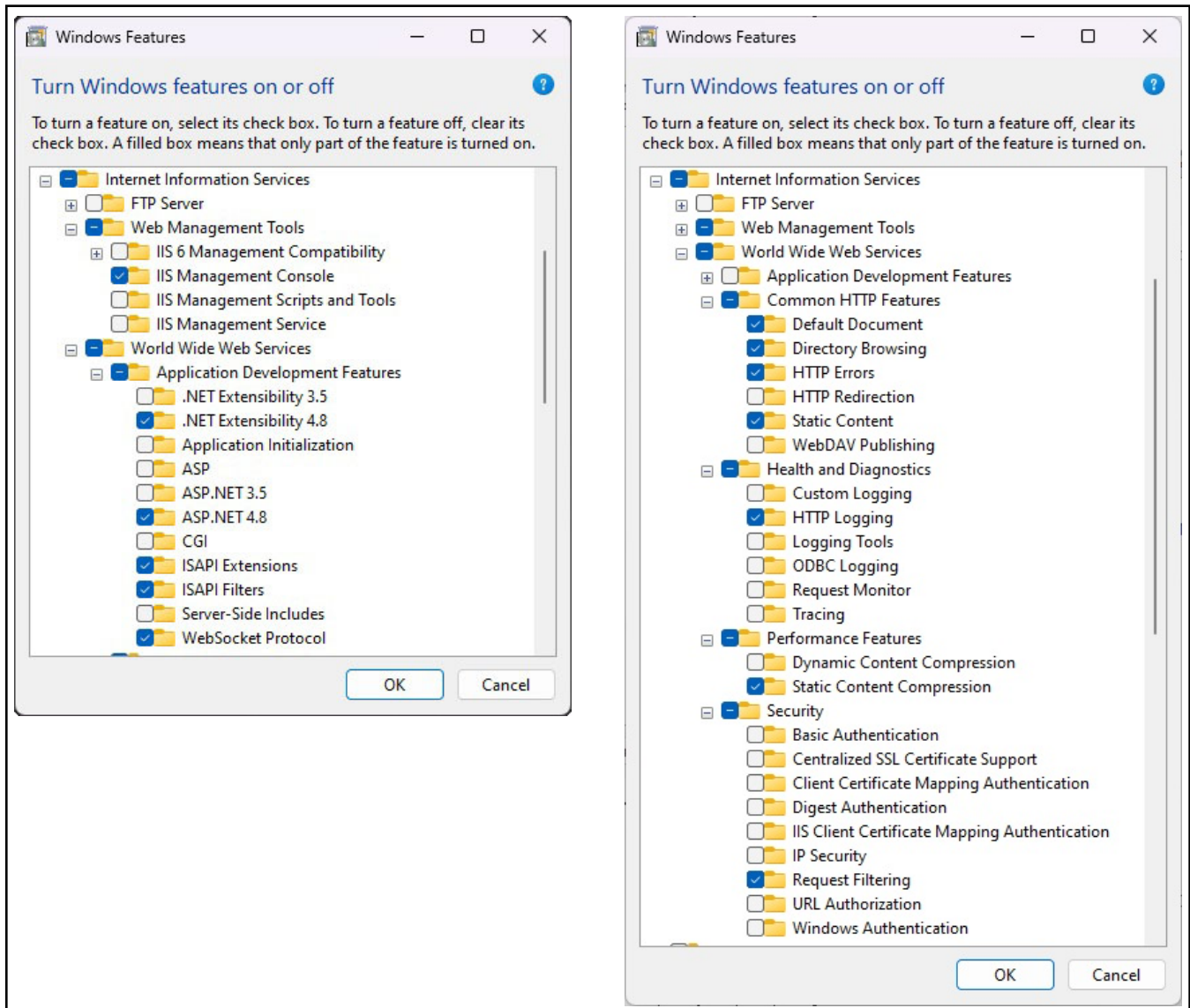

Figure 2-17. Windows Features Configured

3. Download and install the following software from <https://www.iis.net>:
 - IIS URL Rewrite Extension: <https://www.iis.net/downloads/microsoft/url-rewrite>
 - IIS Request Routing Extension: <https://www.iis.net/downloads/microsoft/application-request-routing>

4. Configure IIS as a Reverse Proxy for iDimension SS:

4.1 In Windows Search enter “Internet Information Services” and select the Option that displays.

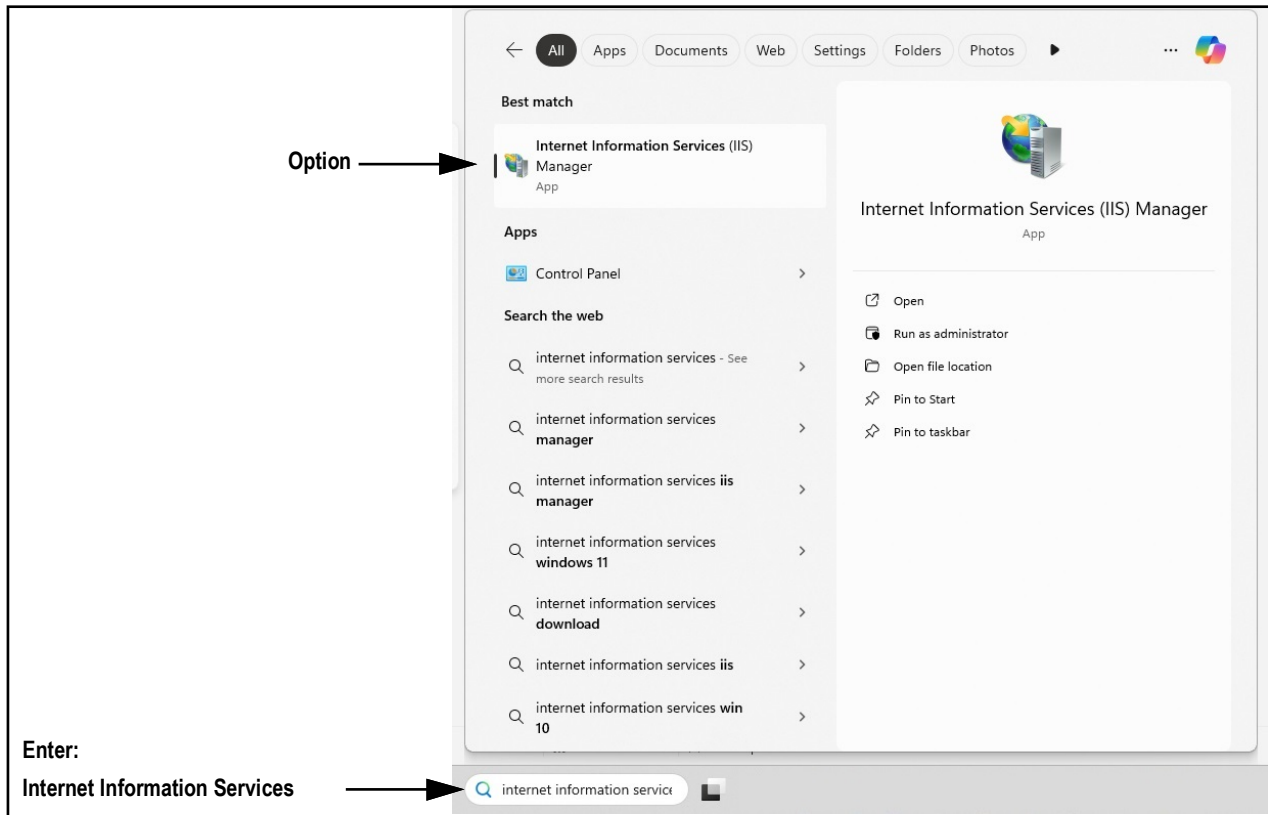

Figure 2-18. Search for Internet Information Services

4.2 Select **Default Web Site** in the left column then double-click **URL Rewrite**.

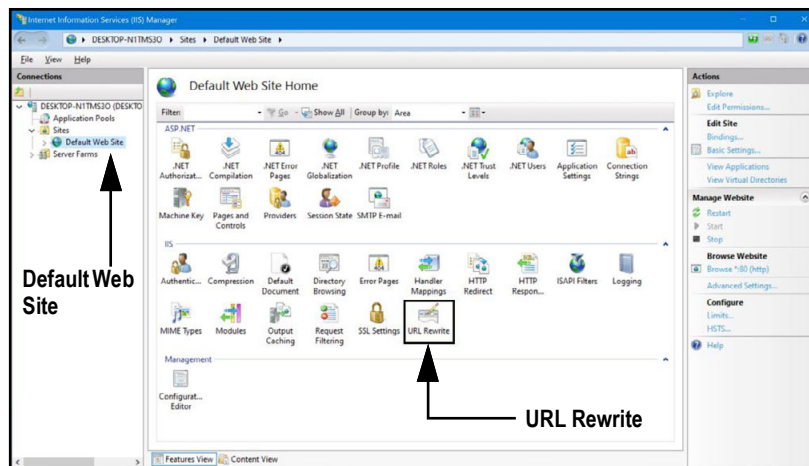

Figure 2-19. Internet Information Services Manager

4.3 Select the **Add Rule(s)** in the right column.

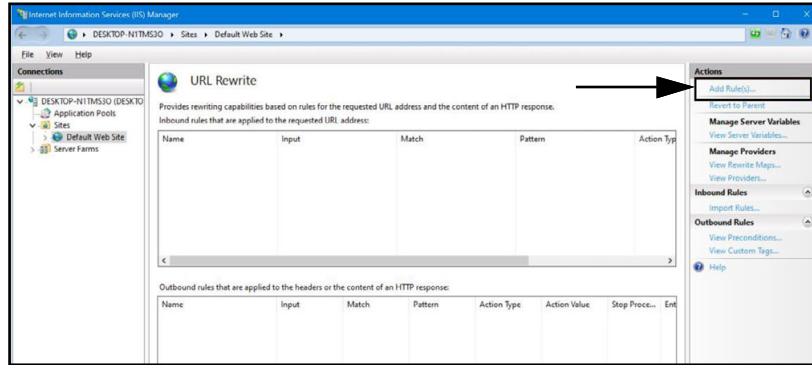

Figure 2-20. Internet Information Services Manager with Add Rule(s) Identified

4.4 The Add Rule(s) window displays.

4.5 Select the **Reverse Proxy** item in the Inbound and Outbound Rules section then select **OK**.

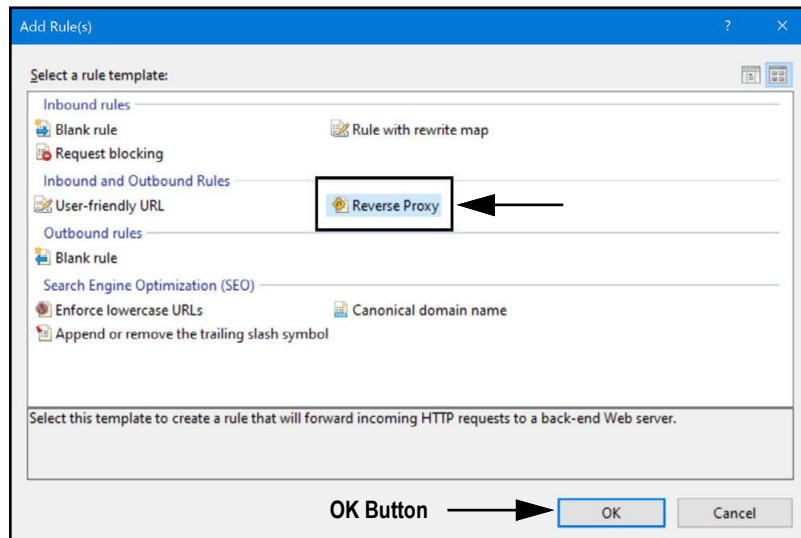

Figure 2-21. Add Rules Window with Reverse Proxy Identified

4.6 A warning may appear requesting to Enable Proxy Functionality.

4.7 Select **OK**.

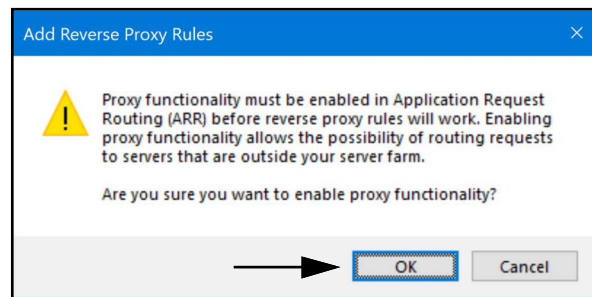

Figure 2-22. Add Reverse Proxy Rules Confirmation Window

- 4.8 The Add Reverse Proxy Rule Window displays.
- 4.9 Enter **127.0.0.1:5000** as the IP address to configure IIS to forward requests to the iDimension SS.
- 4.10 Activate **Enable SSL Offloading** to process HTTPS traffic.
- 4.11 Ensure the **Outbound Rules** is not configured.
- 4.12 Select **OK** to apply the rule.

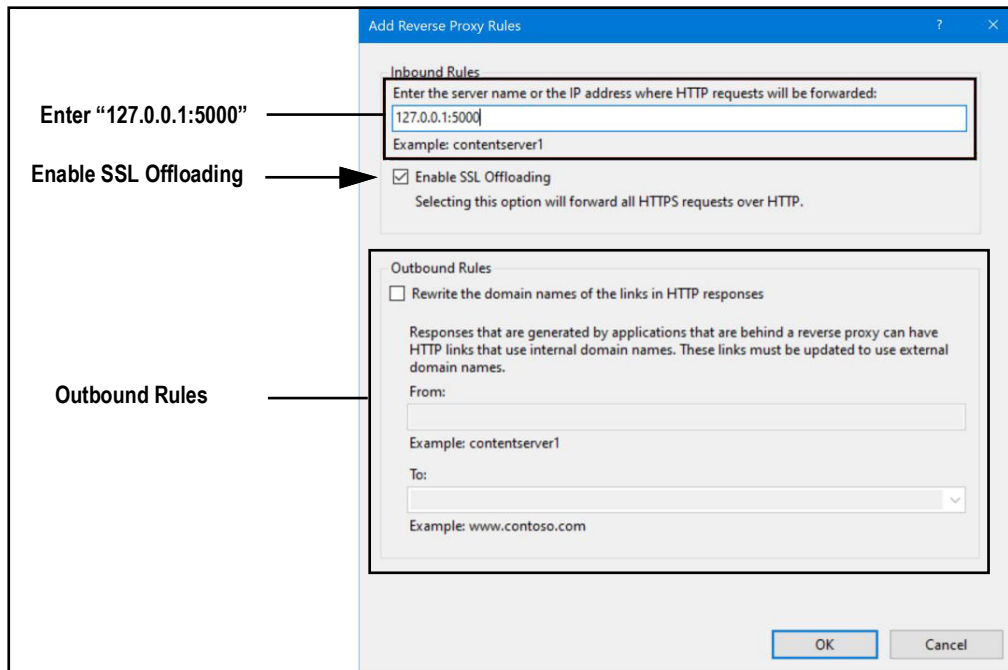

Figure 2-23. Add Reverse Proxy Rules Window with Elements Identified

- 4.13 Once complete, navigate to the configured address to open the iDimension SS. See [Section 3.1 on page 35](#) for information about logging in the first time as an administrator.

2.3 System Configuration

Low level system configuration is typically completed during installation with a text editor such as Notepad (executed as an Administrator). The system configuration is titled `appsettings.json` and located in:

"C:\Program Files\Rice Lake Weighing Systems\iDimSS\" (unless changed during application installation)

Restart the computer for the changes to take effect.

2.3.1 System Configuration File Preparation

During iDimension SS software updates or reinstallation, configuration in the `appsettings.json` is lost. To preserve system configuration, create a copy of `appsettings.json` and title it `appsettings.PRODUCTION.json`.

`appsettings.PRODUCTION.json` is not removed during iDimension SS software updates or reinstallation.

1. Navigate to "C:\Program Files\Rice Lake Weighing Systems\iDimSS\".
2. Locate `appsettings.json`.
3. Create a copy of `appsettings.json` and rename `appsettings.PRODUCTION.json`.
4. Open `appsettings.PRODUCTION.json` with Notepad.
5. Make desired changes to parameters listed [Section 2.3.2](#).
6. Save the file and close Notepad.

2.3.2 System Configuration File Parameters

2.3.2.1 Measurement Storage

To enable or disable measurement storage, locate the following section in the `appsettings.json` file:

```
"IDIMSS": {
  "MeasurementStorage": true,
},
```



NOTE: Set the value for `MeasurementStorage` to 'true' or 'false' as needed.

2.3.2.2 Measurement Auto-Removal

To save space on the Windows computer running the application, automatic pruning of measurement data can be enabled or disabled. Locate the following section in the `appsettings.json` file.

```
"IDIMSS": {
  "EnableMeasurementRecordAutoRemoval": true,
  "MaximumMeasurementRecords": 500,
  "RemovalPercentage": 50.0
},
```

Command	Description
<code>EnableMeasurementRecordAutoRemoval</code>	Set to 'true' or 'false' as needed
<code>MaximumMeasurementRecords</code>	Set to an integer value; This must be determined based on the drive space available on the computer running the application; Care must be given when determining the maximum value based on the number and file size of the images stored with the measurement data; A good rule of thumb would be to assume an image size of 350-400 kilobytes of storage needed for each image stored with a measurement; The default value is 500
<code>RemovalPercentage</code>	a real/decimal value. Set between 0 and 100; The percentage of images removed when the count of stored measurements exceeds the maximum allowed; The default value is 50

Table 2-1. Measurement Auto-Renewal Configuration Commands

2.3.2.3 AWS S3 Measurement Auto-Export

To configure automatic exporting of data to AWS S3, locate the following section in the appsettings.json file.

```
"AwsSimpleStorageServiceOptions": {
  // these parameters can be set here or in environment variables using the format of
  // 'AwsSimpleStorageServiceOptions: ParameterName' where the
  // ParameterName matches the items below
  "S3BucketKey": "DimensionerData/",
  // this should be the Bucket 'key' where the files are stored (similar to a folder name).
  // The filename(s) will be appended to this key.
  "S3Bucket": " ", // this is the bucket name
  "S3Region": " ", // this is the region code where the AWS S3 bucket resides e.g us-east-1
  "S3AccessKey": " ", // this is the IAM user access key
  "S3SecretKey": " ", // this is the IAM user secret key
  "EnableRepublish": false
}
```

Command	Description
S3BucketKey	Enter a string value to set the bucket key where files are stored. Filenames will be appended to this key. <i>Example: With bucket key set to "DimensionerData", filename "LTLData.csv" is stored as "DimensionerData/LTLData.csv".</i>
S3Bucket	Enter a string value to set the bucket name.
S3Region	Enter a string value to set the region code. <i>Example: us-east-1</i>
S3AccessKey	Enter a string value to set the IAM user access key.
S3SecretKey	Enter a string value to set the IAM user secret key.
EnableRepublish	Set to true or false as needed. This enables or disables republishing data to S3; the default value is false.

Table 2-2. AWS S3 Measurement Auto-Export Configuration Commands

2.3.2.4 Vision Camera Options

Set vision camera parameters as needed:

```
"VisionCameraOptions": {
  // this should be in the format of three chars between 000 and 032 if using a camera with no additional memory
  "CameraOneProgramNumber": "000",
  "CameraTwoProgramNumber": "000",
  // allowable values are between 0 to 120 inclusive.
  "RtdMessageDelaySeconds": 0
},
```

Command	Description
CameraOneProgramNumber	Set the camera to the required program number; The default value is 000
CameraTwoProgramNumber	Set the camera to the required program number; The default value is 000
RtdMessageDelaySeconds	Configure the required message delay to RTD desktop display in seconds (up to 120 seconds); the default value is 0

Table 2-3. Cubiscan Emulation Configuration Commands



NOTE: Camera programs are set in software supplied by the camera manufacturer. For more information about setting up camera programs, see camera manufacturer documentation

2.3.2.5 Email

Setup the email server options to enable account confirmation, account recovery, and other email related features.

```
"EmailOptions": {
  "Enabled": false,
  "MailServer": "",
  "MailPort": 587,
  "SenderName": "",
  "FromAddress": "",
  "Account": "",
  "Password": "",
  "EnableSsl": true
}
```

Command	Description
Enabled	Set to 'true' or 'false' as needed; The default value is 'false'
Mail Server	The name or IP address of the SMTP email server; This information can be obtained from the mail provider or your IT department; Leave blank to disable email functionality
Mail Port	The TCP port used by the mail server; This information can be obtained from the mail provider or your IT department
Sender Name	The display name of the sender
From Address	The sender's email address
Account	Set as the account name used for authentication on the email server; This is typically an email address
Password	Set as the account's password
Enable SSL	Set to 'true' or 'false' to enable/disable secure sockets layer encryption when authenticating and sending email messages; This information can be obtained from the mail provider or your IT department; The default value is 'true'

Table 2-4. Email Configuration Commands

2.3.2.6 Cubiscan Emulation

Setup the Cubiscan emulation options to enable external systems to trigger capture operations via the Cubiscan request/response protocol.

```
"CubiscanOptions": {
  "Enabled": true,
  "TcpPort": 5002,
  "MaxConnections": 1,
  "CloseAfterProtocolResponse": true
  "DimensionUnitOfMeasure": "in",
  "WeightPassthrough": false
},
```

Command	Description
Enabled	Set to 'true' or 'false' as needed; The default value is 'false'
TcpPort	The port used by the application to monitor for incoming connections and requests; The default value is 5002
MaxConnections	The maximum number of concurrent external connections; The default value is 1
CloseAfterProtocolResponse	Set to 'true' to cause the application to immediately close the connection to the external system after sending the response; This immediately frees the application to accept a new request; The default value is 'true'
Dimensions Unit of Measure	The unit of measure for the length, width, height, and volume. Acceptable values are "in" (inches/cubic inches), "cm" (centimeters/cubic centimeters) and "od" (Old Dominion centimeters/cubic feet). If the value is not one of the values listed, inches is assumed. <i>The conversion assumes that the dimensioner is sending the dimensions in inches as its native unit of measure.</i>
Weight Passthrough	Set to 'true' to enable the weight value included in the Cubiscan request to pass through to the response message. If set to 'false', the weight obtained by iDimension SS will be inserted into the response message.

Table 2-5. Cubiscan Emulation Configuration Commands

2.3.2.7 Mettler Emulation

Setup the Mettler emulation options to enable external systems to trigger capture operations via the Mettler request/response protocol.

```
"MettlerOptions": {
  "Enabled": true,
  "TcpPort": 6001,
  "MaxConnections": 1,
  "CloseAfterProtocolResponse": true
  "DimensionUnitOfMeasure": "in",
  // ValueOrder is used to set the order of the Length, Width, and Height.
  // Set the order using L, W, and H in the order desired.
  // If the value set here is invalid, the order will be set to LWH by default.
  "ValueOrder": "LWH"
}
```

Command	Description
Enabled	Set to 'true' or 'false' as needed; The default value is 'false'
TcpPort	The port used by the application to listen for incoming connections and requests; The default value is 6001
MaxConnections	The maximum number of concurrent external connections; The default value is 1
CloseAfterProtocolResponse	Set to 'true' to cause the application to immediately close the connection to the external system after sending the response; This immediately frees the application to accept a new request; The default value is 'true'
Dimensions Unit of Measure	The unit of measure for the length, width, height, and volume. Acceptable values are "in" (inches/cubic inches), "cm" (centimeters/cubic centimeters) and "od" (Old Dominion centimeters/cubic feet). If the value is not one of the values listed, inches is assumed. <i>The conversion assumes that the dimensioner is sending the dimensions in inches as its native unit of measure.</i>

Table 2-6. Cubiscan Emulation Configuration Commands

2.3.2.8 Enable Remote Forklift Data Support

Setup the remote forklift data support to allow the application to query a remote system running the iDimension SS Forklift Data Management application for forklift data. This allows for centralized forklift data management.

```
"ForkliftOptions": {
  "EnableRemoteForkliftApiLink": false,
  "RemoteForkliftApiAddress": "https://localhost:5051/",
  "MaxCacheTimeoutHours": 24,
  "CacheTimeoutHours": 8,
  "MaxCacheSize": 100
}
```

Command	Description
EnableRemoteForkliftApiLink	Set to 'true' or 'false' as needed; The default value is 'false'; When set to 'true'; the local forklift views are hidden and all data management functions are done at the remote system
RemoteForkliftApiAddress	Set to the URL of the remote system; This would typically be similar to "https://RemoteComputerNameOrIpAddress:5051/"
MaxCacheTimeoutHours	The maximum amount of time that an item is held in the cache regardless if it was recently accessed
CacheTimeoutHours	The time an item is held in the cache; If the item is accessed, the timeout is reset
MaxCacheSize	The maximum number of items (forklift items) that are held in the cache; If additional items are added, older items are purged

Table 2-7. Enable Remote Forklift Data Support Configuration Commands

2.3.2.9 Scanner Support

Setup the barcode scanner support to allow the application to accept data from a barcode scanner to trigger the capture process.

```
"ScannerOptions": {
  "Enabled": false,
  "TcpPort": 7001,
  "MaxConnections": 1,
  "ClosedAfterProtocolResponse": true
}
```

Command	Description
Enabled	Set to 'true' or 'false' as needed; The default value is 'false'
TcpPort	The port used by the application to listen for incoming connections and requests; The default value is 7001
MaxConnections	The maximum number of concurrent external connections; The default value is 1
CloseAfterProtocolResponse	Set to 'true' to cause the application to immediately close the connection to the external system after sending the response; This immediately frees the application to accept a new request; The default value is 'true'

Table 2-8. Enable Remote Forklift Data Support Configuration Commands

2.3.2.10 Remote I/O Support

Setup the Remote I/O hardware support to allow the system to trigger capture operations from a digital signal. The Remote I/O hardware also contains two outputs that indicate a shipping method according to the Shipping Method Analyzer.

```
"RemoteIOOptions": {
  "Enabled": false,
  "IpAddress": "0.0.0.0"
}
```

Command	Description
Enabled	Set to 'true' or 'false' as needed; The default value is 'false'
IP Address	The IP address of the Remote I/O hardware

Table 2-9. Enable Remote Forklift Data Support Configuration Commands

2.3.2.11 Pro Number/Manifest Number Label

Setup an application specific name for the PRO or Manifest number used to link a capture operation to an external manifest or other data. This only changes the user interface labels in the application and does not change any computer-to-computer interface labels like export, REST API message, etc.

```
"InterfaceOptions": {
  "ManifestNumberLabel": "Pro Number/Manifest Number"
}
```

Command	Description
Manifest Number Label	Set as desired for the specific application requirements

Table 2-10. Manifest Number Label Commands

2.3.2.12 Export Options

Modify data during the export process.

```
"ExportOptions": {
  "ReplaceVolumeValueWithConvertedVolumeValue": false
}
```

Command	Description
ExportOptions	Set to replace the volume in the dimensioner unit of measure with the configured converted unit of measure

Table 2-11. Export Options

2.3.2.13 Pro Number Substitution Options

Setup to allow replacement of space characters with a different, valid character.

```
"ProNumberSubstitutionOptions": {
  "Enabled": false,
  "SubstitutionCharacter": " _ "
}
```

Command	Description
Enabled:	Set to true to enable the feature.
Substitution Character:	The single character used to replace the space character. Default is the underscore character.

Table 2-12. Pro Number Substitution Options

2.3.2.14 Xml Export Options

Used to control the xml export process to ensure a valid output.

```
"XmlExportOptions": {
  // set 'true' to remove invalid characters, set 'false' to escape invalid characters.
  "RemoveInvalidXmlCharacters": true
}
```

Command	Description
Remove Invalid XML Characters:	Set to true to remove characters that are not allowed in XML data. Set to false to escape the invalid (not allowed) characters.

Table 2-13. Xml Export Options

2.3.2.15 Web Display Options

Used to control automatic timeouts of the data shown in the web real-time display.

```
"WebDisplayOptions": {
  "SuccessTimeout": 20000,
  "ErrorTimeout": 0
}
```

Command	Description
Success Timeout:	The timeout in milliseconds. Once exceeded, the data is automatically cleared. A value of zero disables the timeout.
Error Timeout	The timeout in milliseconds. Once exceeded, the data is automatically cleared. A value of zero disables the timeout.

Table 2-14. Web Display Options

2.4 Initial Browser Navigation

Depending on configuration navigate to <http://localhost:5000> or <https://localhost:5001> on the computer where the application was installed.

If using <https://localhost:5001> a security warning appears due to the usage of a self-signed certificate. The certificate must be imported to remove the warning message. In the following procedures describe how to export and import the certificate. In these procedures Google Chrome is used, operation in other browsers may vary.

2.4.1 Export the Certificate

1. Navigate to <https://localhost:5001> in the computer where the application was installed.
2. A security warning displays.
3. Select the **Not Secure** button near the address bar.

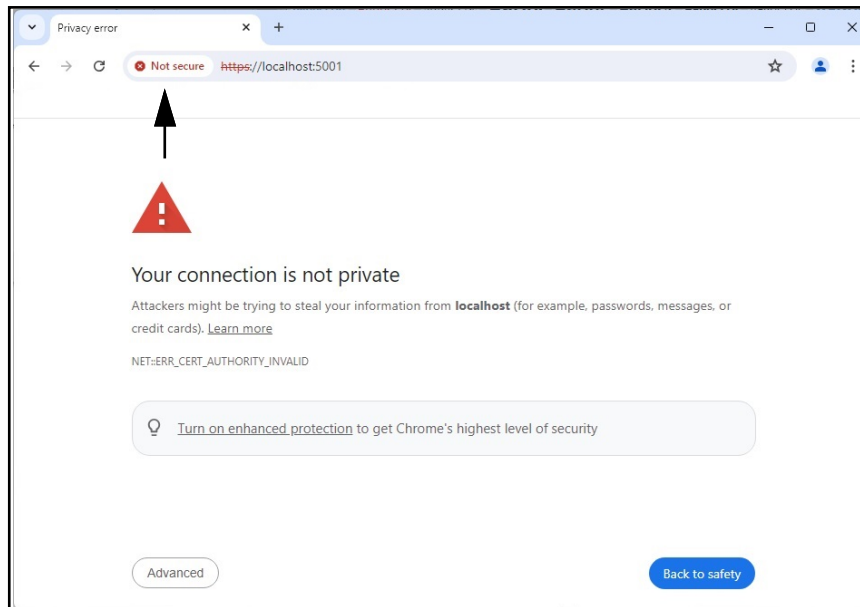

Figure 2-24. Security Warning in Web Browser Identified

4. Select the **Certificate is not valid** button.

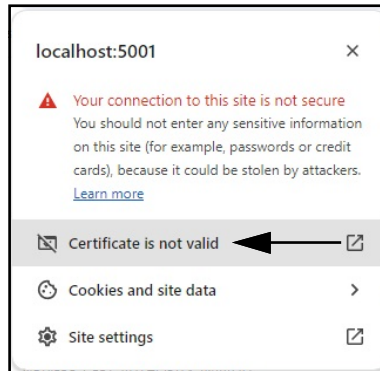

Figure 2-25. Security Warnings with Certificate is not valid Identified

- Verify the **Issued To** and **Issued By** fields match.

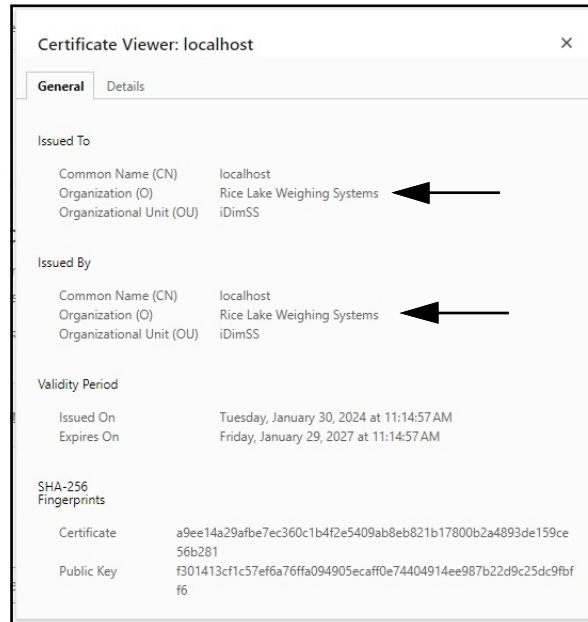

Figure 2-26. Certificate General Information

- Select the **Details** tab and then **Export**.

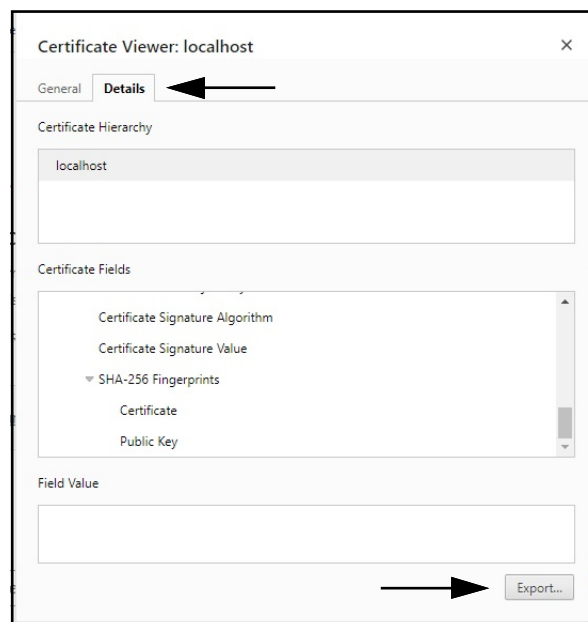

Figure 2-27. Certificate Detailed Information with Export Identified

7. The **Save As** dialog displays.
8. Enter **IDIMSS** as the file name.
9. Select **Save**.

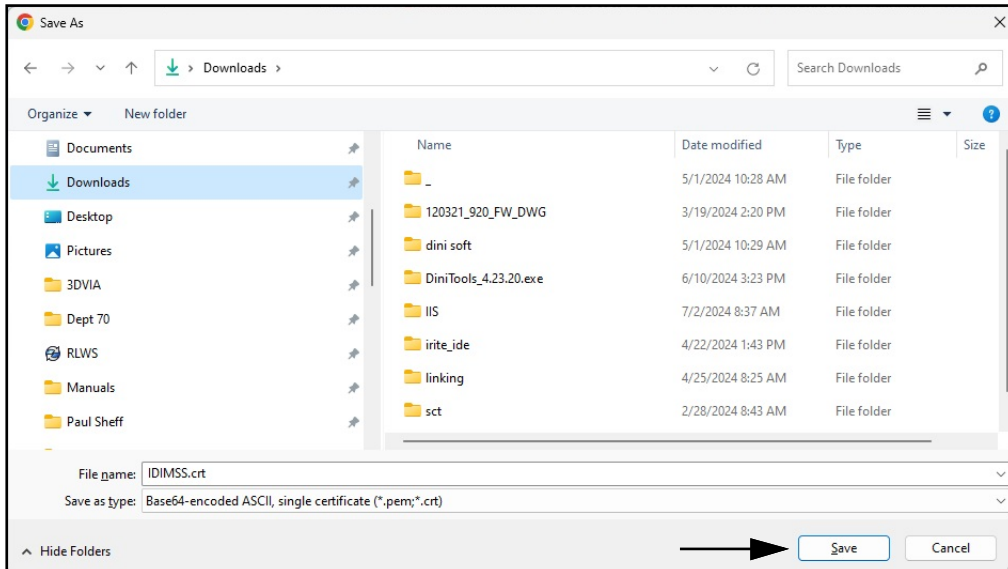

Figure 2-28. Save As Dialog with Save Identified

10. Open Windows File Explorer then navigate to the **Downloads** folder.
11. Open the **IDIMSS.cer** file.
12. The Certificate details dialog appears.
13. Select **Details** tab.
14. Select **Copy to File**.

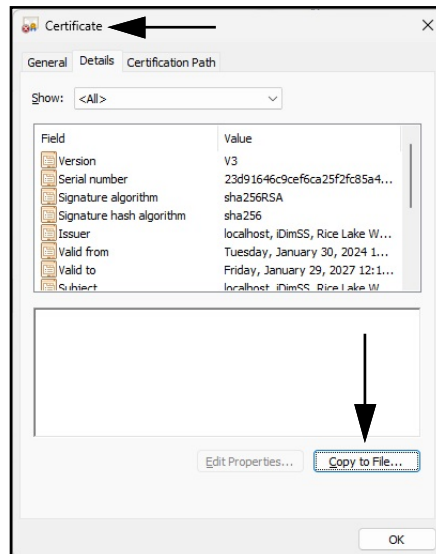

Figure 2-29. Certificate Dialog with Copy to File Identified

15. The Certificate Export Wizard displays.
16. Select **Next**.

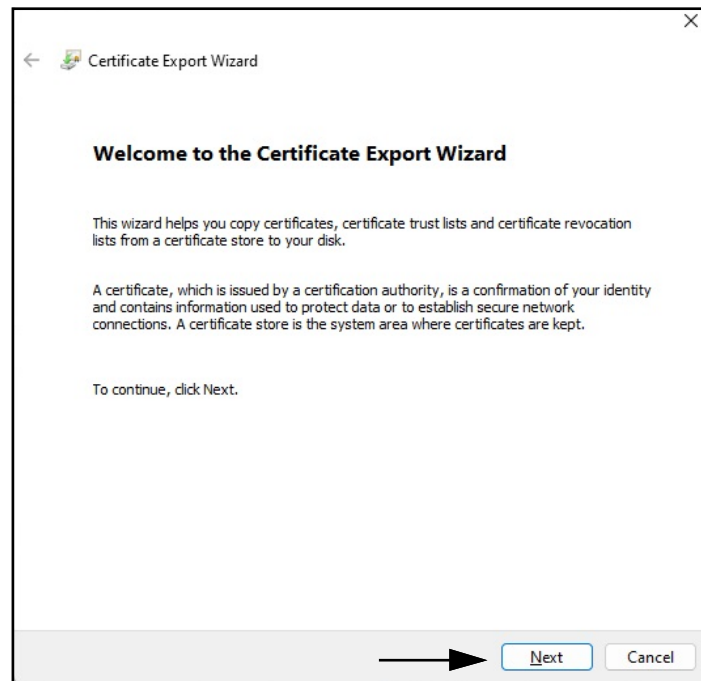

Figure 2-30. Certificate Export Wizard with Next Identified

Select **DER encoded binary x.509** and then **Next**.

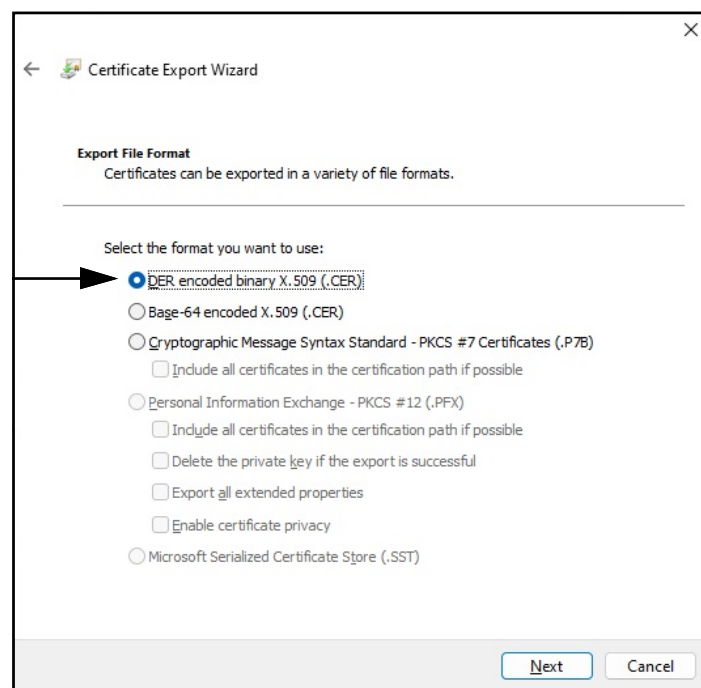

Figure 2-31. Certificate Export Wizard with Format Identified

17. Click **Browse** and select your Downloads folder.

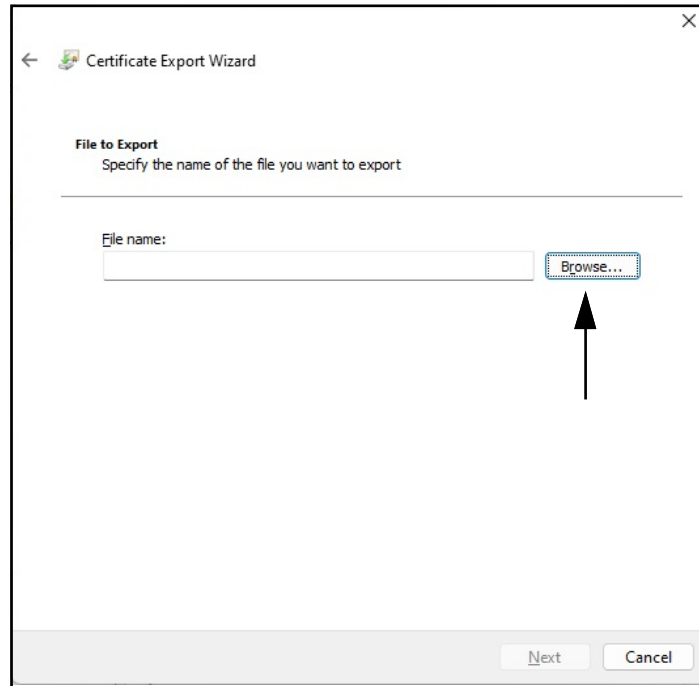

Figure 2-32. Certificate Export Wizard with Browse Identified

18. Enter IDIMSS as the filename and click **Save**.

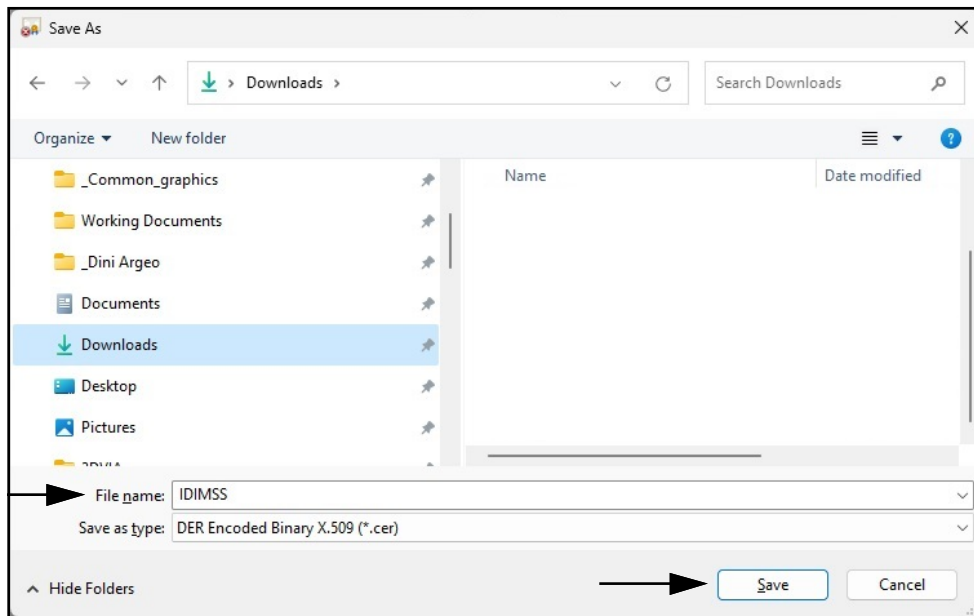

Figure 2-33. Certificate Export Wizard Save As Dialog

19. Click **Next**.

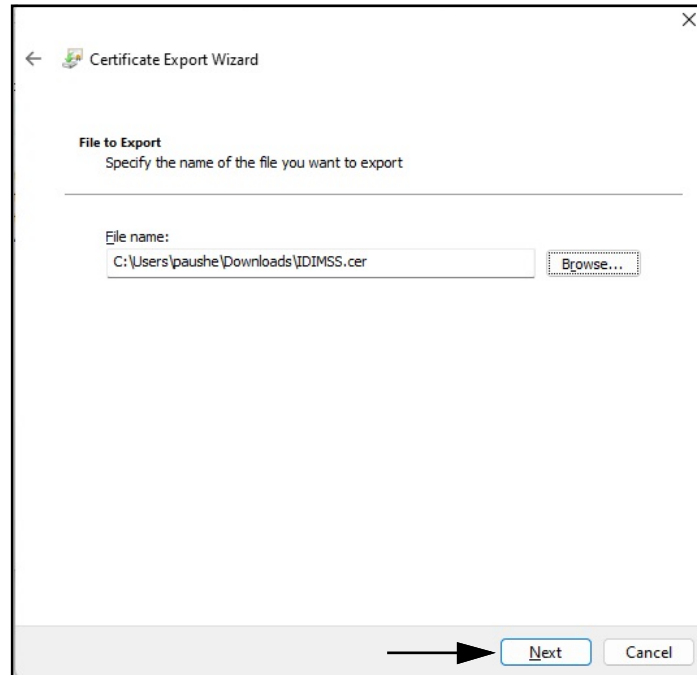

Figure 2-34. Certificate Export Wizard File Name with Next Identified

20. Click **Finish**.

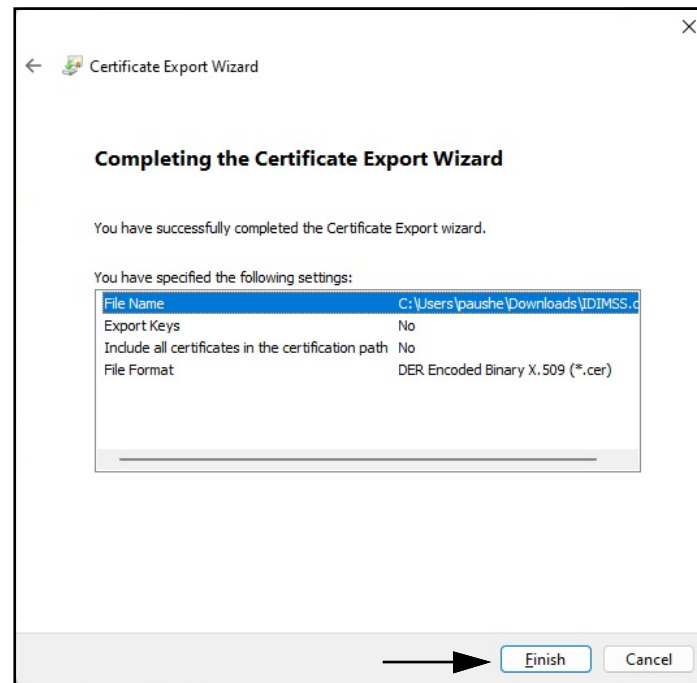

Figure 2-35. Certificate Export Wizard Completion with Finish Identified

21. When the export is successful, a confirmation prompt displays. Click **OK** to close the prompt and Wizard.



Figure 2-36. Certificate Export Wizard Successful Export Dialog

2.4.1.1 Import the Certificate

1. Open Windows File Explorer then navigate to the **Downloads** folder.
2. Open the **IDIMSS.cer** file.
3. The **Certificate Import** Wizard displays.
4. Select **Current User** and then **Next**.

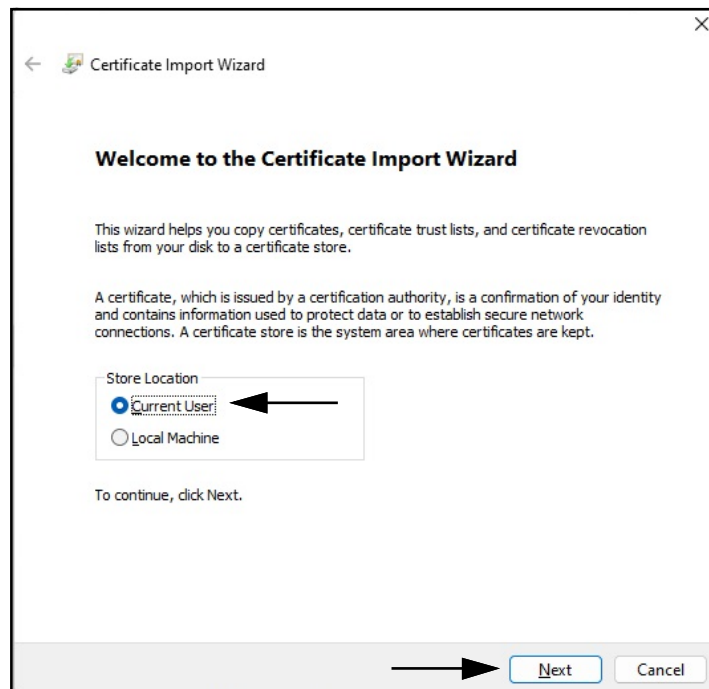

Figure 2-37. Certificate Import Wizard with Current User Identified

- In the Certificate Store step, select **Place all certificates in the following store** and then **Browse**.

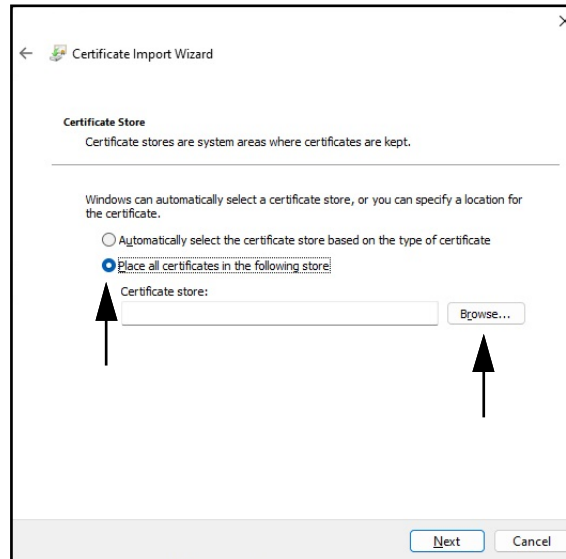

Figure 2-38. Certificate Import Wizard Storage Selection with Browse Identified

- Select **Trusted Root Certification Authorities** and then **OK**.

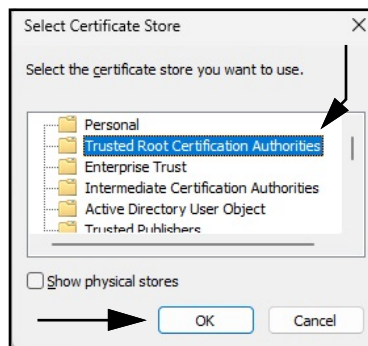

Figure 2-39. Certificate Import Wizard Certificate Store Selections with OK Identified

- Select **Next**.

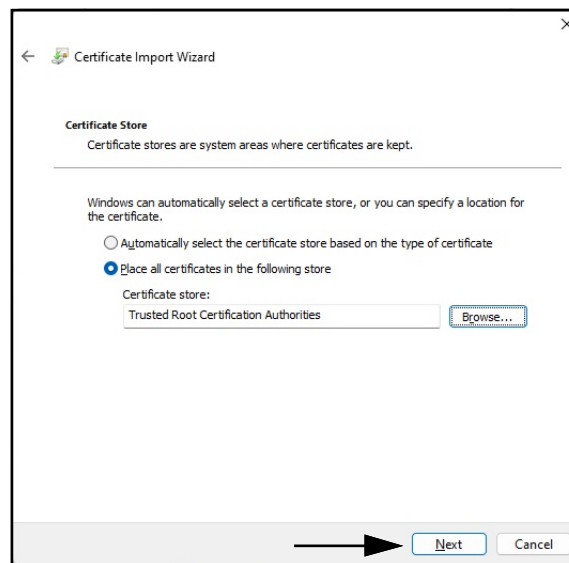

Figure 2-40. Certificate Import Wizard Confirmation with Next Identified

- Select **Finish**.

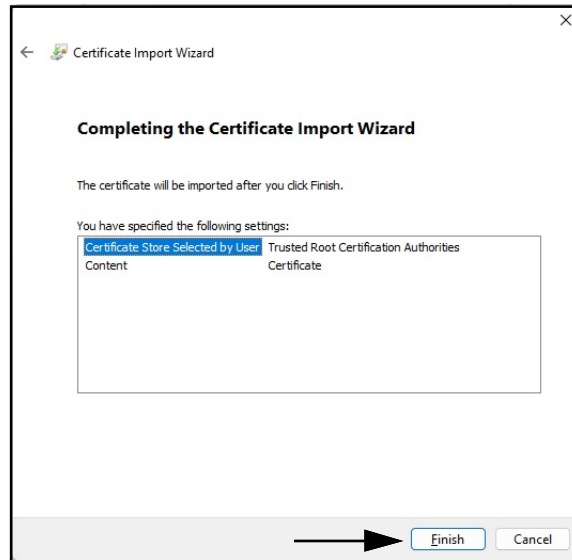

Figure 2-41. Certificate Import Wizard Completion

9. The following Security Warning displays.
10. Select **Yes** to place the certificate in the certificate store. A success dialog displays.



NOTE: If success dialog does not display, contact your local IT department for assistance.



Figure 2-42. Certificate Import Wizard Security Warning

11. Close the Browser and then reopen it.
12. Navigate to <https://localhost:5001> then the site displays without the security warnings.

3.0 Login, User Management and Configuration

This section discusses iDimension SS Login, User management and Configuration. Topics in this section include:

- Login ([Section 3.1 on page 35](#))
- Main Page ([Section 3.2 on page 37](#))
- User Configuration ([Section 3.3 on page 38](#))
- Configuration ([Section 3.4 on page 42](#))
 - Dimensioner Setup and Configuration ([Section 3.4.1 on page 42](#))
 - Scale Setup and Configuration ([Section 3.4.2 on page 49](#))
 - Forklift Setup and Configuration ([Section 3.4.3 on page 53](#))
- Global Setup and Configuration ([Section 3.4 on page 42](#))
- About ([Section 3.6 on page 74](#))

3.1 Login

3.1.1 Access iDimension SS

1. iDimension SS may be accessed from a supported web browser (see [Section 1.1 on page 7](#)).
 - Navigate to:<http://localhost:5000>, <https://localhost:5001>, {host ip address}:5000 or {host ip address}:5001, if using the computer where the iDimension SS was installed.
 - Navigate to the configured proxy address (see [Section 2.2 on page 15](#)), if iDimension SS is configured to work with an existing default website.

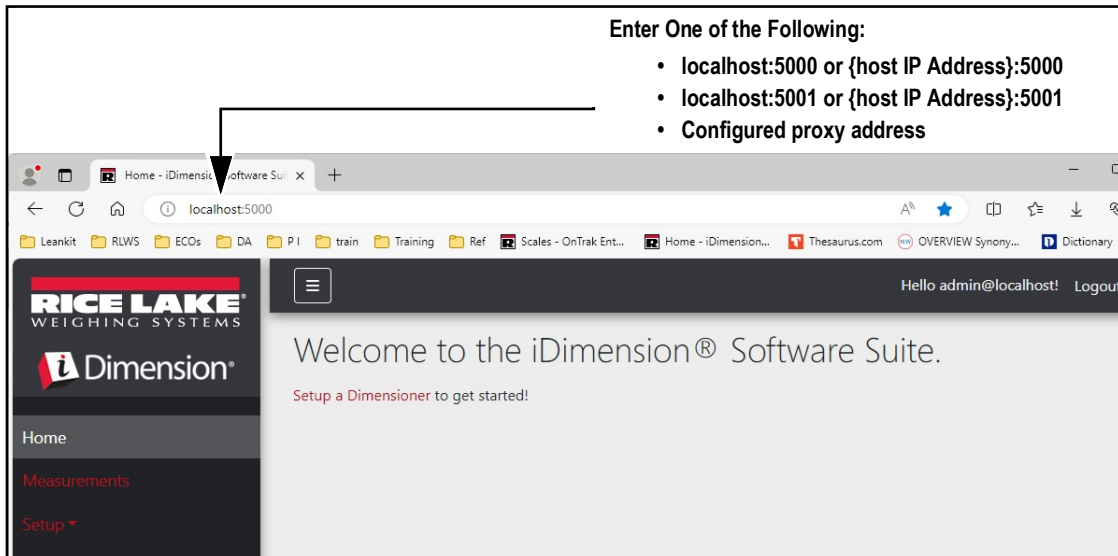

Figure 3-1. iDimension SS Enterprise Opened In Microsoft Edge

3.1.2 Initial Login

The iDimension SS system is configured with a default administrator account.

1. Access iDimension SS.
2. Select **Login**.

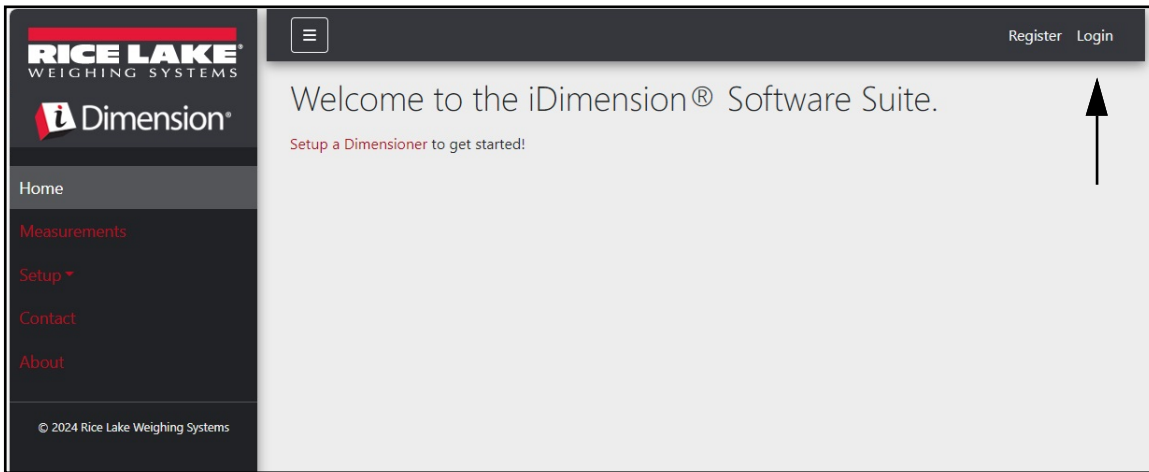

Figure 3-2. Login Button

3. Enter account information.



NOTE: By default, the system creates an administrator user to perform all site operations. This account has the following name and password.

- Name: `admin@localhost`
- Password: `PASS$word1`

4. Select **Log in**.



NOTE: Changing the default password as soon as possible after installation is highly recommended.

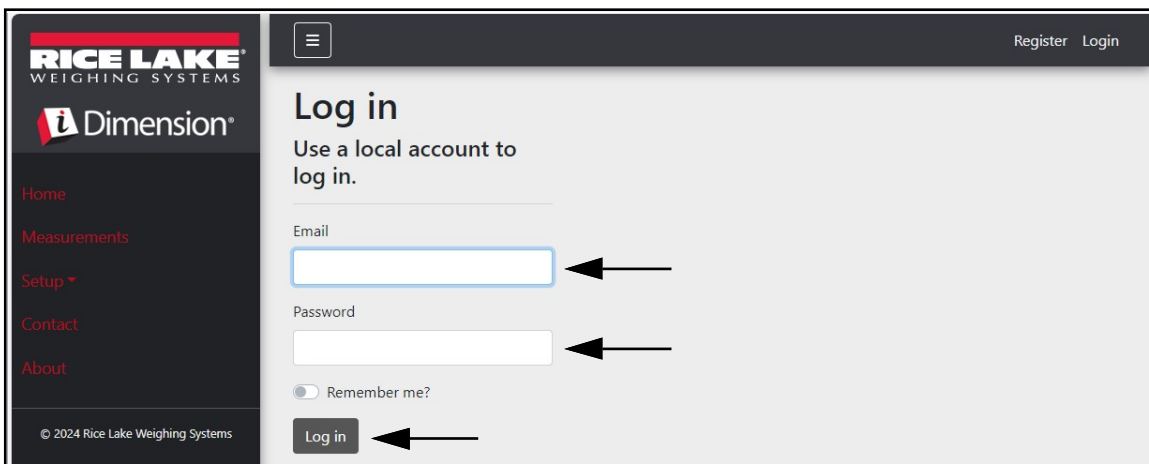

Figure 3-3. Log In Page

3.2 Main Page

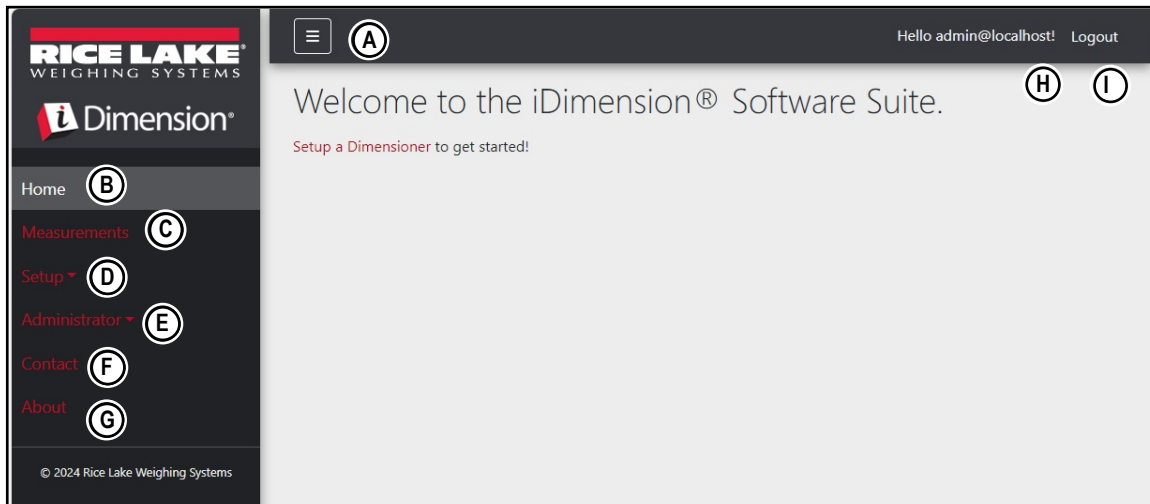

Figure 3-4. iDimension SS Home Page

Item	Function	Description
A	Menu Button	Collapses or expands the Main menu.
B	Home Option	Opens Home page and displays welcome message, configured dimensioners, or real time-displays.
C	Measurements	Opens Measurements page that provides access to processed measurements (see Section 4.0 on page 75)
D	Setup	Contains the following pages: Global Configuration (Section 3.4.1 on page 42 through Section 3.5 on page 58), Scales (Section 3.4.2 on page 49), Dimensioners (Section 3.4.1 on page 42) and Forklifts (Section 3.4.3 on page 53). NOTE: Only available to Administrator accounts
E	Administrator	Contains the following pages: Users (see Section 3.3 on page 38), Systems Settings (see Section 5.3 on page 82), Log Files (see Section 5.2 on page 81), Failed Scans (see Section 5.1 on page 80) and Dimensioner Test (see Section 5.4 on page 85). NOTE: Only available to Administrator accounts.
F	Contact Option	Opens Contact Information for Rice Lake Weighing Systems
G	About Option	Opens About page which provides iDimension SS version and build information.
H	Account Option	Opens Account Management page which provides the functionality to change information for the active account (see Section 3.3 on page 38).
I	Logout Option	Logs out of iDimension SS.

Table 3-1. iDimension SS Element Descriptions

3.3 User Configuration

3.3.1 User Registration

New users can be created by Selecting the **Register** link on the site.

1. Select the **Register** button.



NOTE: The Register link is only available when no-one is currently logged into the site.

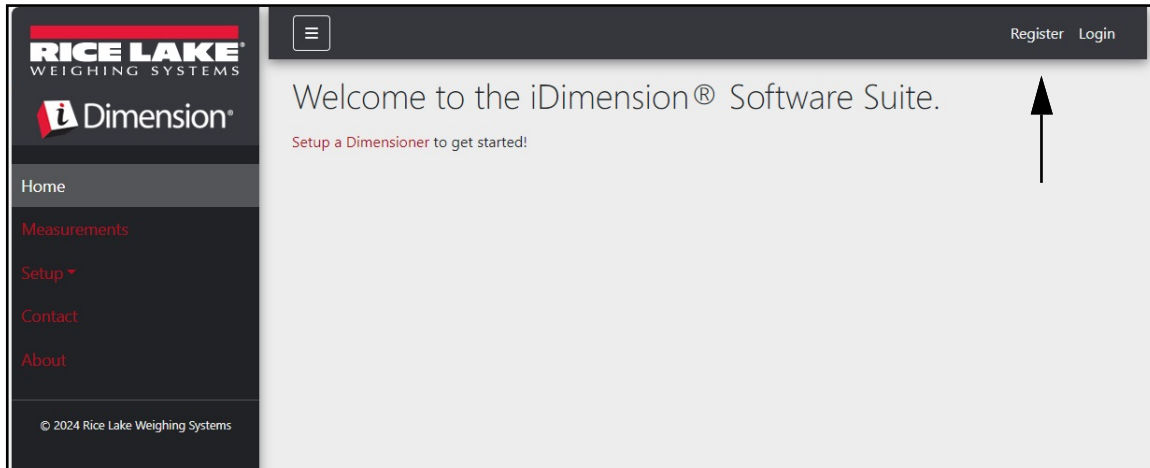

Figure 3-5. Register Button

2. Enter account information.
3. Select **Register** to create a new user.

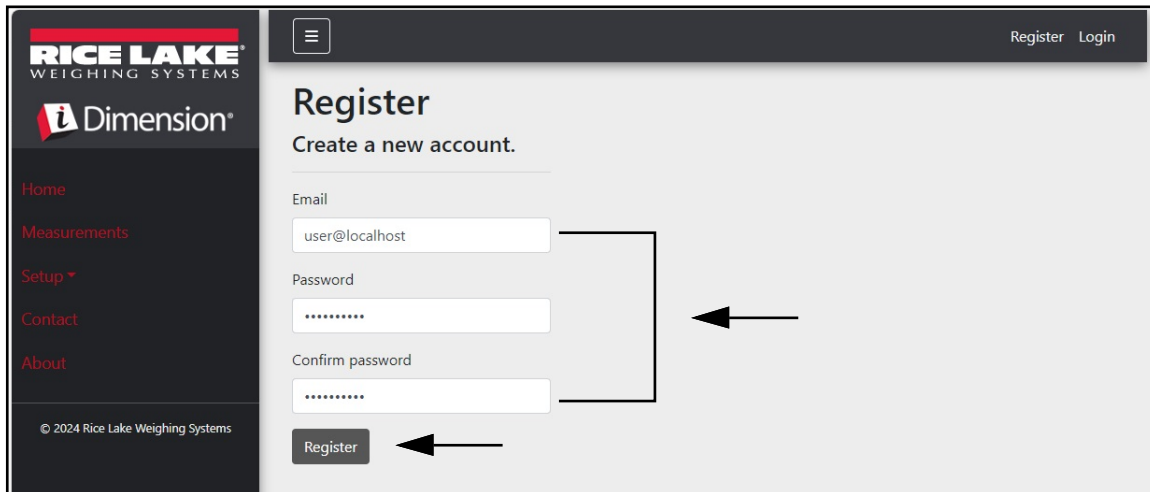

Figure 3-6. Account Registration Page



NOTE: Accounts created through registration are automatically set as with the User role and do not have access to Administrator or Setup menu. However, The User role can be changed to Administrator if required (see [Section 3.4.1 on page 42](#)).

3.3.2 Reset Password

IMPORTANT: In order to reset, a password an email server must be configured (see [Section 2.3 on page 20](#)). If an email server is not configured, reset password emails are not generated and consequently forgotten passwords are not reset.

1. Open iDimension SS.
2. Select **Login** then **Forgot your password?**.

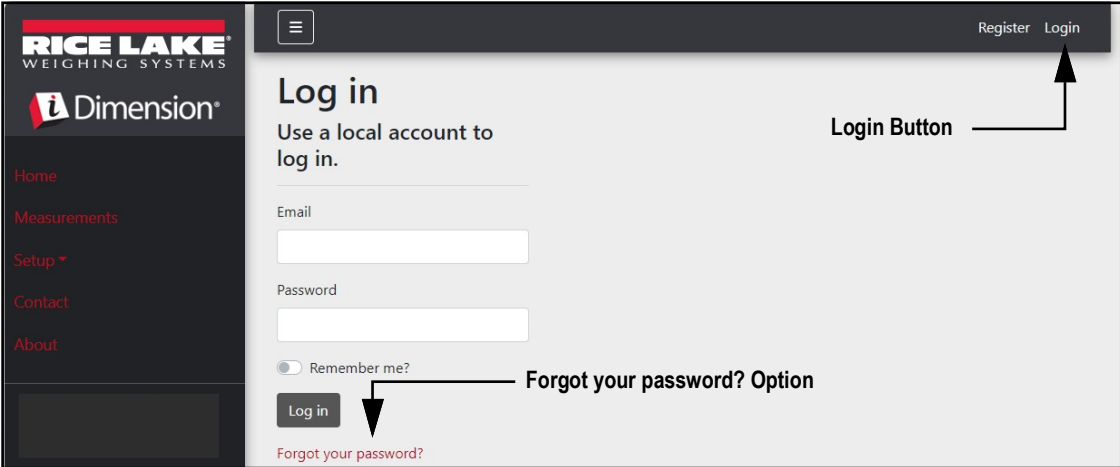

Figure 3-7. Login Prompt with Forgot your password Option Identified

3. Enter email address associated with the account.
4. Select **Submit**.

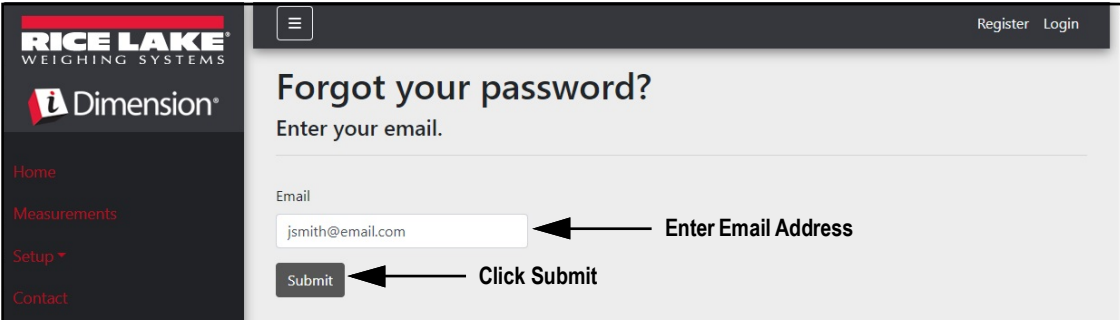

Figure 3-8. Forgot Your Password Page

5. After activating Submit, iDimension SS indicates the password reset information is sent to the specified email address.

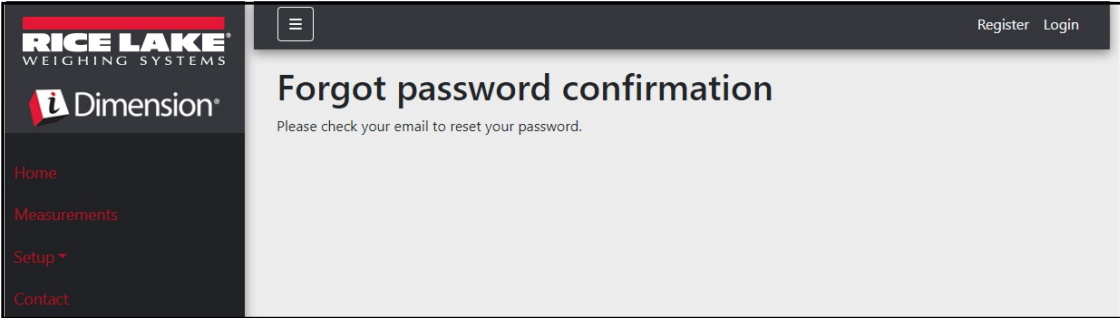

Figure 3-9. Forgot Password Confirmation Page

6. Open email and follow instructions to complete password reset process.

3.3.3 User Management



NOTE: The Users menu item is only available to Administrators.

3.3.3.1 Edit User

1. Select **Administrator > Users**. The Users page displays.
2. Select **Edit** associated with the user account that requires change.

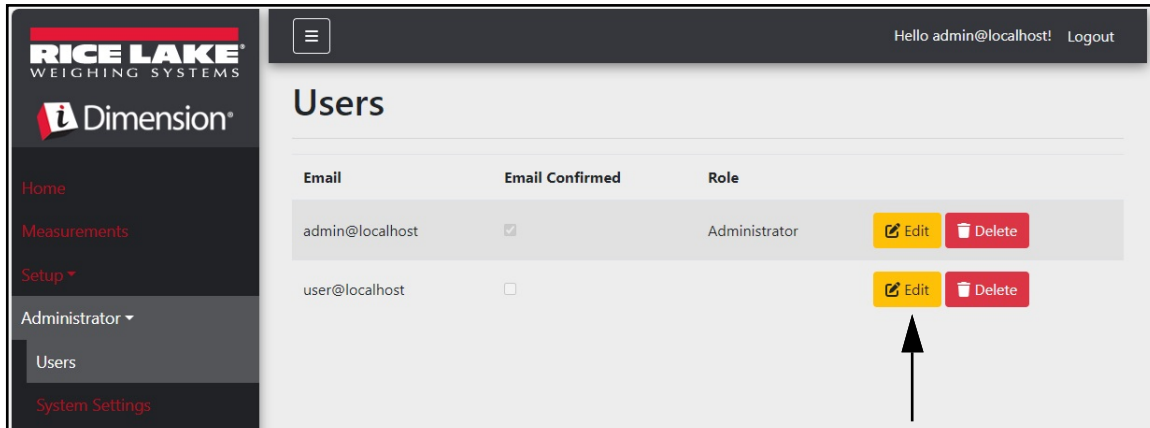

Figure 3-10. Users Page

3. **Edit User** page displays.
4. Edit user information:
 - **Email:** The user's email address. This field is read only.
 - **Email Confirmed:** Set to indicate that the email provided by the user has been confirmed to be valid.
 - **Role:** Set to Administrator or User as needed. Administrators have access to all menus while users do not have access to Setup or Administrator menus.
5. Select the **Save** button to commit the changes or **Back to List** button to return to the main users list.

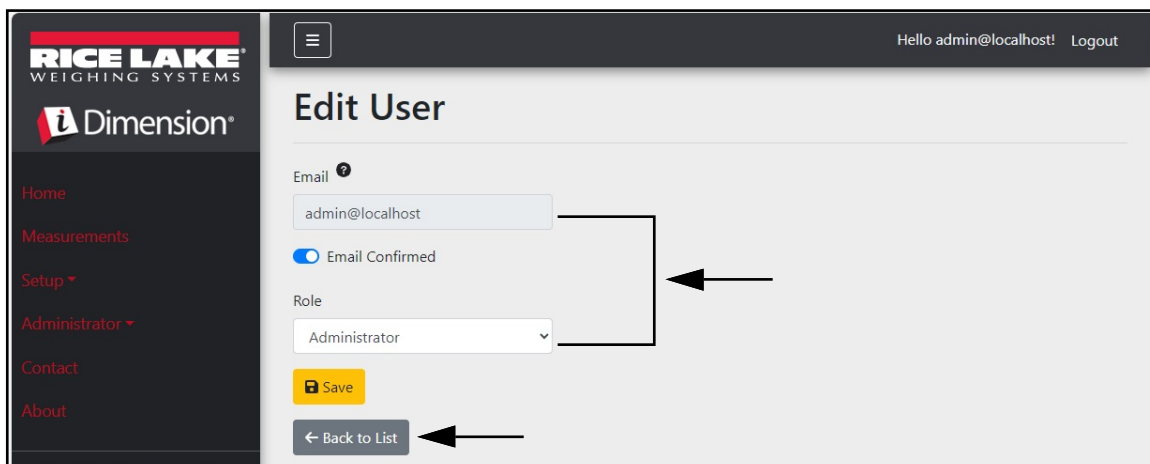

Figure 3-11. Edit User Page

3.3.3.2 Delete User

The system prompts for user deletion confirmation.

1. Select the **Administrator > Users** link in the menu. The Users page displays.
2. Select **Delete**.

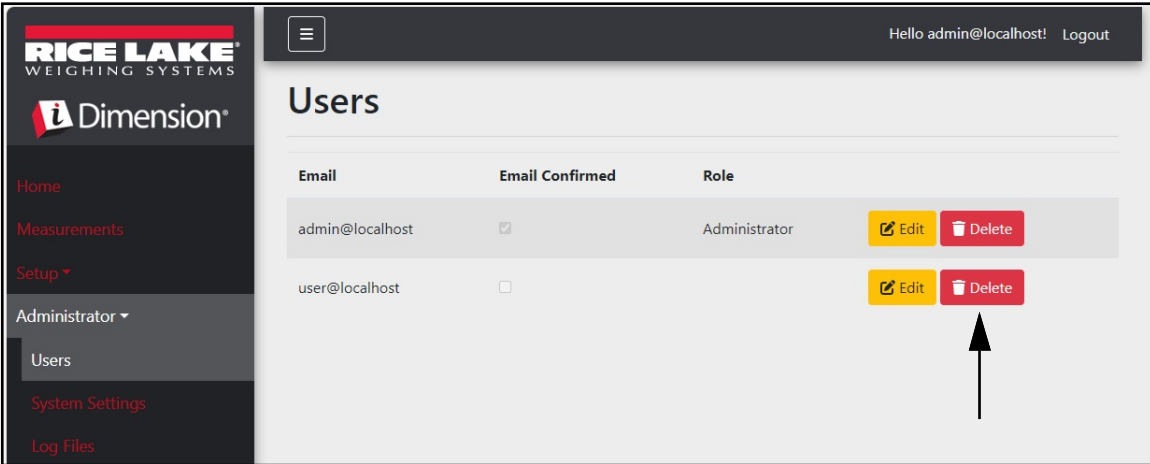

Figure 3-12. Users Page

3. **Delete User** page displays.
4. Select the **Delete** button to proceed or **Back to List** to return to the main user list.

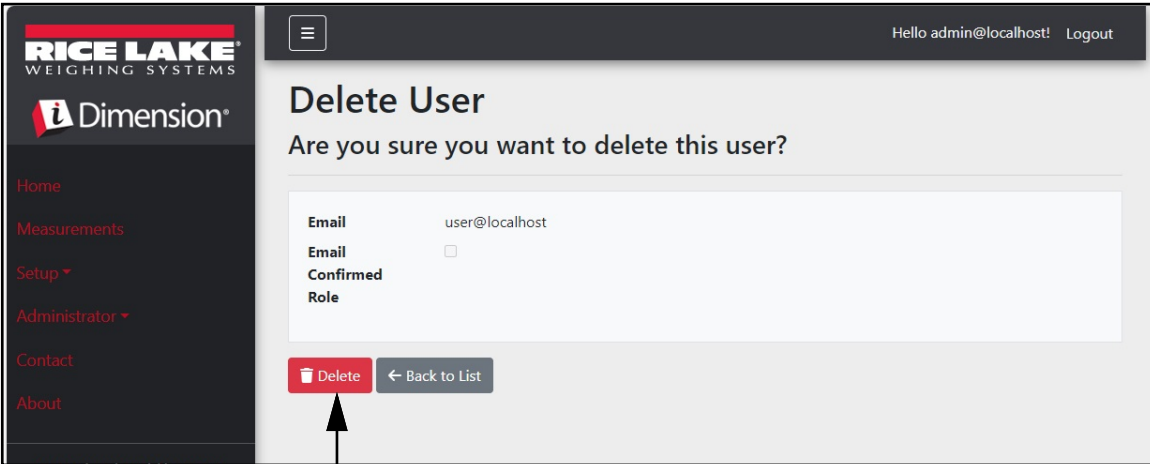

Figure 3-13. Delete User Page

3.4 Configuration

iDimension SS provides various menus and settings for configuring Scales, Dimensioners and Forklifts. This section discusses configuration for these items in the following sections:

- Dimensioner Setup and Configuration ([Section 3.4.1 on page 42](#))
- Scale Setup and Configuration ([Section 3.4.2 on page 49](#))
- Forklift Setup and Configuration ([Section 3.4.3 on page 53](#))



NOTE: Additional Configuration settings are located through the Global Configuration page (see [Section 3.5 on page 58](#)).

3.4.1 Dimensioner Setup and Configuration

This section describes how to configure dimensioners.

3.4.1.1 Creating a New Dimensioner

1. Select **Setup a Dimensioner** on the welcome page or **Setup > Dimensioners** in the menu to access the dimensioner configuration functions.

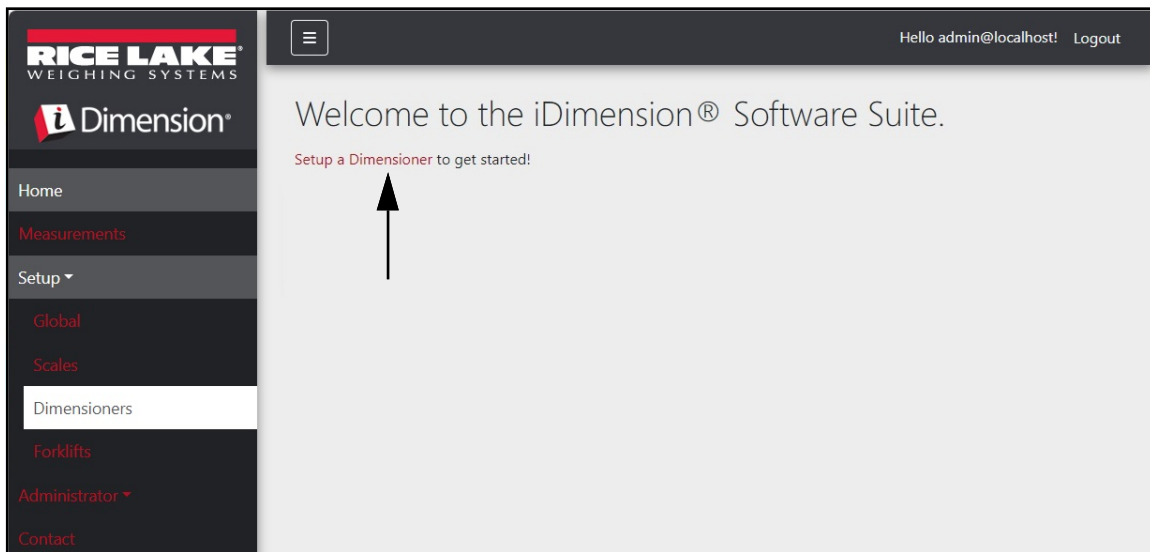

Figure 3-14. Select Dimensioner

2. Select the **+ Create New** button to add a new dimensioner to the system.

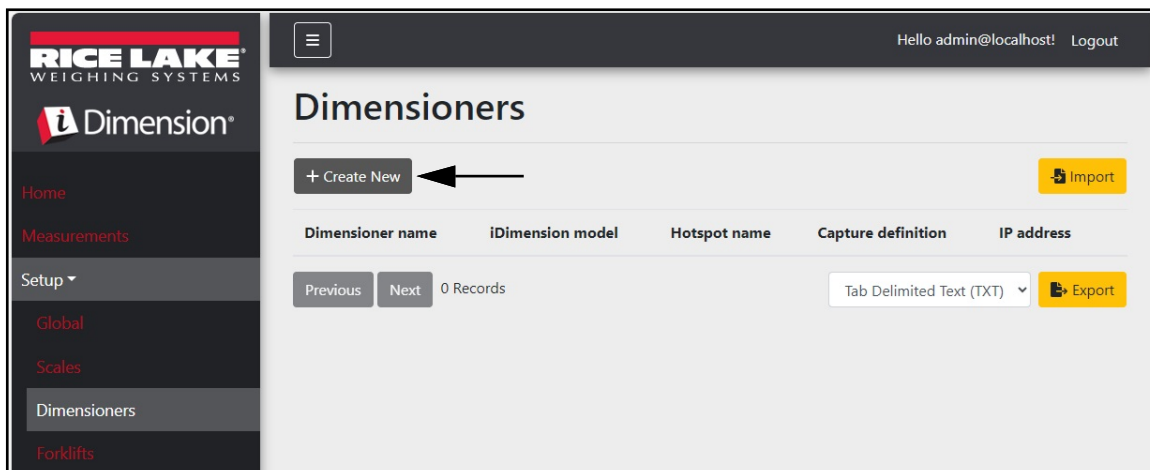

Figure 3-15. Dimensioners Page with + Create New Button Identified

3. Create Dimensioner page displays.

Figure 3-16. Create Dimensioner Page

4. Configure the following parameters:

- **Dimensioner Name:** Name of the dimensioner.
- **IP address:** The IP address of the dimensioner; For example, 192.168.0.2.
- **Use this dimensioner as system default:** Since the Cubiscan and Mettler emulation components do not specify a dimensioner name, nor does the barcode scanner interface, the 'System Default' dimensioner is used when those trigger mechanisms are utilized.
- **iDimension model:** Select appropriate iDimensioner model.
- **Stop and Go enabled:** Set to indicate that the dimensioner supports Stop & Go functionality. Ensure that a capture definition "StopGoCapDef" is created in the iDimension Qubevu Manager. When selected, iDimension SS sends the capture definition "StopGoCapDef" instead of "QVDemo". When triggering Stop and Go, a forklift ID is required to iDimension SS to trigger the iDimension.



NOTE: For use with iDimension LTL only, this feature is used in conjunction with the iDimension SS forklift database. When a trigger command is sent with a forklift ID to identify the Stop and Go unique forklift used, the iDimension SS sends "StopGoCapDef" capture definition to the iDimension. Ensure the iDimension LTL firmware is configured for this new capture definition.

If all forklift brackets types are similar, this does not require selection. Check you capture definitions in iDimension LTL for proper configuration. When using the separate iDim SS forklift database software, this selection is not required.

- **Capture definition:** The name of the configured capture definition in the dimensioner; Select the **Insert Typical** button to insert the most common value.



NOTE: Capture definitions are configured in the iDimension QubeVu Manager firmware.

- **Hotspot name:** The name of the configured hotspot in the dimensioner. Not all dimensioners require this parameter; Select the **Insert Typical** button to insert the most common value:
 - For iDimension LTL, HS1 is used (see note below)
 - For iDimension PWD, leave blank
 - For iDimension Flex, leave blank



NOTE: Hotspot is only used on QubeVu version 5.X.X firmware; it is not required for newer 6.X.X firmware.

- **Camera names use to determine dimensions (delimited list):** A comma delimited list of configured camera names; Select the **Insert Typical** button to insert the most common value; This feature allows you to determine which camera you would like to configure to determine a successful result in iDim SS. The same camera names must be included for the "Process images from these camera names" to store into iDim SS measurements database iDimension LTL default:
 - QVRemotelImage1,QVRemotelImage2,QVRemotelImage3,QVRemotelImage4,QVRemotelImage5,QVRemoteCameralImage1
 - When using two Axis color cameras, add ",QVRemoteCameralImage2" to the end of the default.
- **Process images from these cameras (delimited list):** A comma delimited list of camera names; Any image processing is applied to these cameras only; Select the **Insert Typical** button to insert the most common value; This feature allows you to determine which camera you would like to Store in the iDim SS measurement database. The camera names must match "Camera names use to determine dimensions" to store into iDim SS measurements database:
 - QVRemotelImage1,QVRemotelImage2,QVRemotelImage3,QVRemotelImage4,QVRemotelImage5,QVRemoteCameralImage1,QVRemoteCameralImage2
 - When using two Axis color cameras, add ",QVRemoteCameralImage2".
- **Combine capture images into a single image:** Enable to perform image composition on the captured images using the image composition rules.
- **Composite Images List:** Input a comma delimited list of cameras that will be included in the composite image. Select **Insert Typical** to set the default configuration then modify the list as needed.
- **Annotate images with measurement data:** Enable to apply the configure image annotation rules to the images captured from this dimensioner.
- **Export image from the cameras (delimited list):** Sends images to Primary FTP from configured cameras. The cameras installed on each dimensioner can be reviewed in QubeVu. Select **Insert Typical** to set the default configuration then modify the list as needed.
- **Export images from these cameras to secondary FTP destination (delimited list):** Sends images to Secondary FTP from configured cameras. The cameras installed on each dimensioner can be reviewed in QubeVu. Select **Insert Typical** to set the default configuration then modify the list as needed.
- **Failed Scan External Camera One IP Address:** The iDimension SS provides a feature to capture an image of failed scans. Enter the IP address of the camera to capture the image. For example: if an out-of-bounds measurement occurs, iDim SS stores the image in Failed Scans.
- **Failed Scan External Camera TWO IP Address:** This feature is to be used if iDim SS is to be loaded onto a local mobile computer with a 192.168.0.X network configuration. If iDim SS is installed on a network computer, all IP addresses associated with the iDimension device must be on the same network.
- **(Optional) Vision camera one IP address:** The first vision camera's IP address used by the dimensioner to visually verify freight.
- **(Optional) Vision camera one TCP port:** The first vision camera's TCP port used by the dimensioner.
- **(Optional) Vision camera one IP address:** The second camera's IP address used by the dimensioner to visually verify freight.

- **(Optional) Vision camera one TCP port:** The second vision camera's TCP port used by the dimensioner.
 - **Scale is attached to dimensioner:** Enable to indicate that a scale is directly attached to the dimensioner device
 - **Weight is provided manually:** Enable to indicate that the weight and units are provided manually during a capture process or provided by the remote computer if triggered via an API call.
 - **Remote scale associated with dimensioner:** If set, the configured scale is interrogated during the capture operation for its current weight value and units.
 - **Enable the web real-time display for this dimensioner:** Enables the Web Real-Time Display for the associated dimensioner that is accessible from the Home page.
 - **Enable the QR code display in the web real-time display:** Adds QR Code with encoded measurement date to the Web Real-Time Display. The content of the QR codes are configured in the Capture Complete View Configuration page (see [Section 3.5.10 on page 68](#)).
 - **Enable the test dimensioner button in the web real time display:** Adds test button to Web Real-Time Display and performs a test capture to verify if cameras are operating correctly. Test results are not stored on the network.
5. Select the **Save** button to commit the changes or **Back to List** button to return to the main users list.

3.4.1.2 Dimensioner Management

Edit an Existing Dimensioner

1. Select the **Setup > Dimensioners** in the menu.
2. Select **Edit** associated with the dimensioner that requires change.

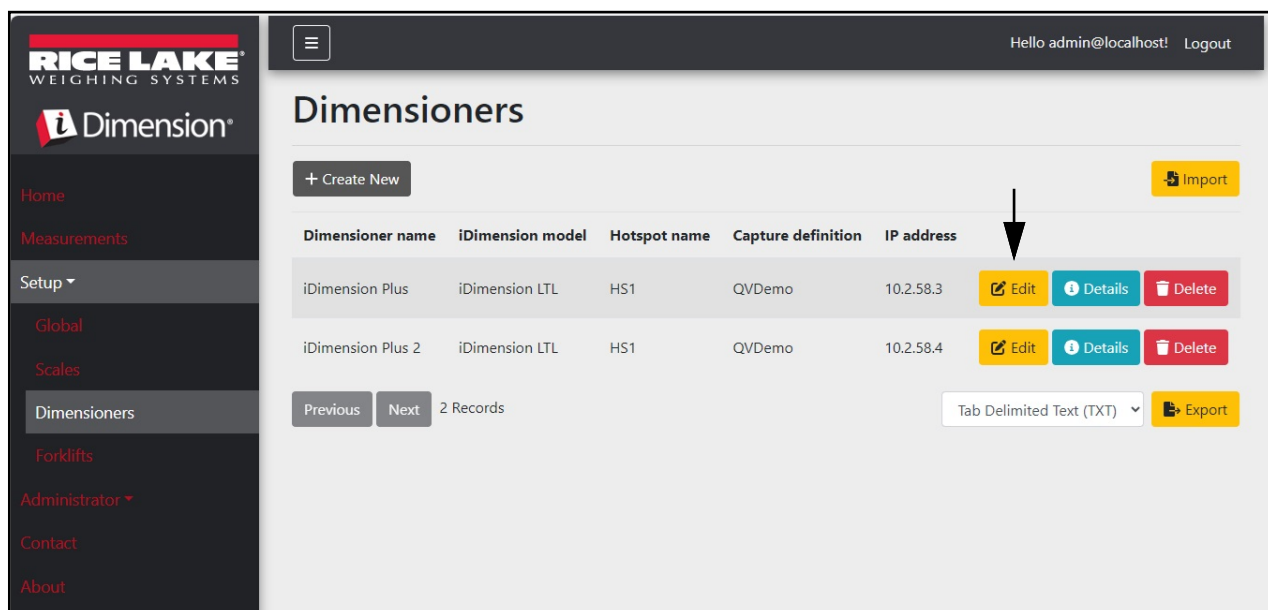

Figure 3-17. Dimensioners Page with Edit Identified

3. **Edit Dimensioner** page displays (see [Section Figure 3-18. on page 46](#)).
4. Make the desired changes to dimensioner settings ([Section 3.4.1 on page 42](#)).
5. Select the **Save** button to commit the changes, or select **Back to List** to return to the main dimensioner list.

Edit Dimensioner

Dimensioner name [?]

IP address [?]

Use this dimensioner as the system default [?]

iDimension model [?]

Dimensioner supports Stop & Go feature [?]

Capture definition [?]

Hotspot name [?]

Cameras names used to determine dimensions (delimited list) [?]

Process images from these cameras (delimited list) [?]

Combine capture images into single image [?]

Composite Images List [?]

Annotate images with measurement data [?]

Export images from these cameras (delimited list) [?]

Export images from these cameras to secondary FTP destination (delimited list) [?]

Failed Scan External Camera One IP address [?]

Failed Scan External Camera Two IP address [?]

Vision camera one IP address [?]

Vision camera one TCP port [?]

Vision camera two IP address [?]

Vision camera one TCP port [?]

Scale is attached to dimensioner [?]

Weight is provided manually [?]

Remote scale associated with dimensioner [?]

Enable the web real-time display for this dimensioner [?]

Enable the QR code display in the web real-time display [?]

Enable the test dimensioner button in the web real-time display [?]

Figure 3-18. Edit Dimensioner Page

View an Existing Dimensioner Configuration

- 1. Select the **Setup > Dimensioners** in the menu.
- 2. Select **Details**.

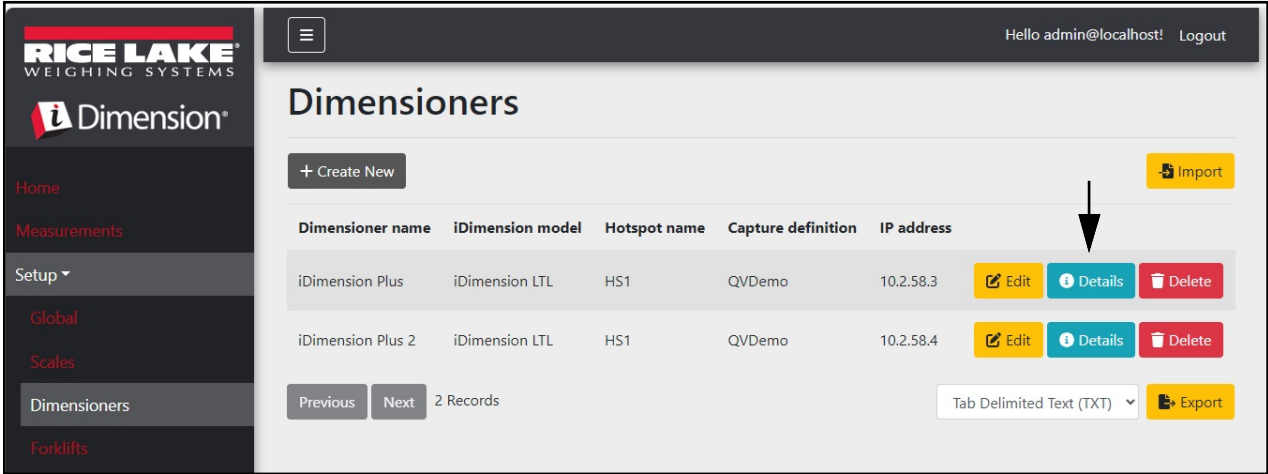

Figure 3-19. Dimensioners Page Details Button

- 3. **Dimensioner Details** page displays.
- 4. Scroll through page to review configuration.
- 5. Select **Edit** button to edit the dimensioner or **Back to List** to return to the main dimensioner list.

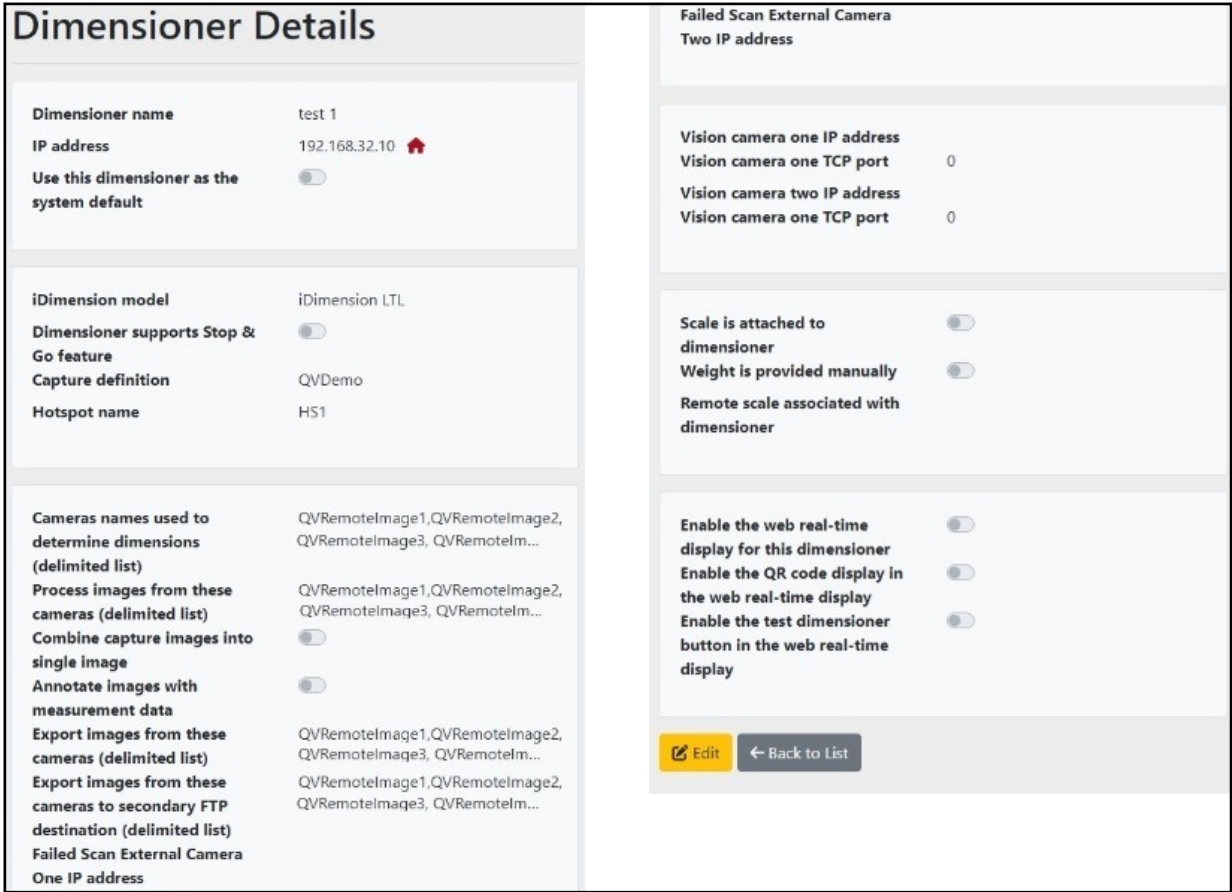

Figure 3-20. Dimensioner Details Page

Delete a Dimensioner

1. Select the **Setup > Dimensioners** in the menu.
2. Select **Delete**.

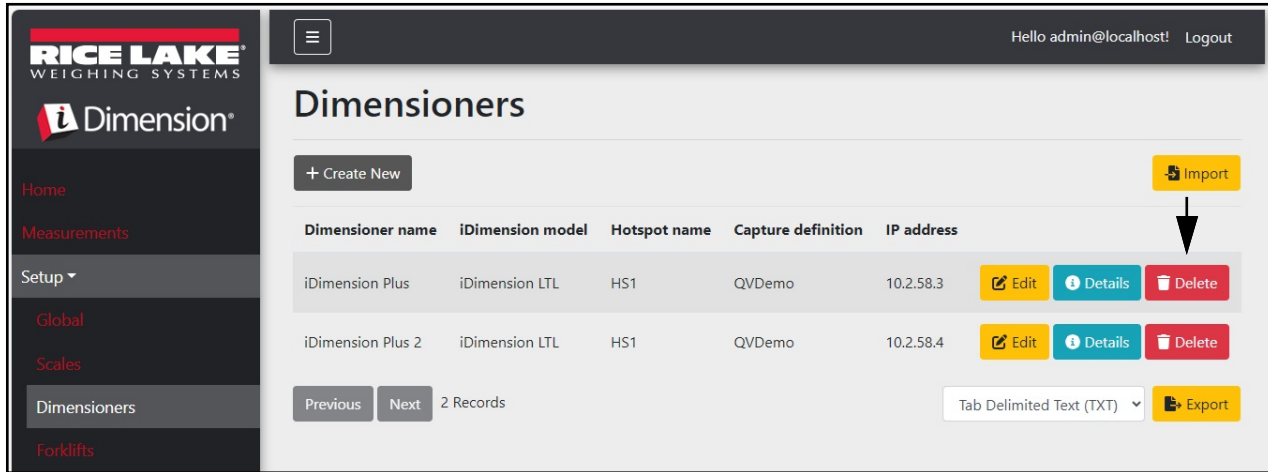

Figure 3-21. Dimensioners Page Delete Button

3. **Delete Dimensioner** page displays.
4. The system prompts to confirm the delete operation prior to deleting the dimensioner.
5. Select the **Delete** button to proceed or **Back to List** to return to the main dimensioner list.

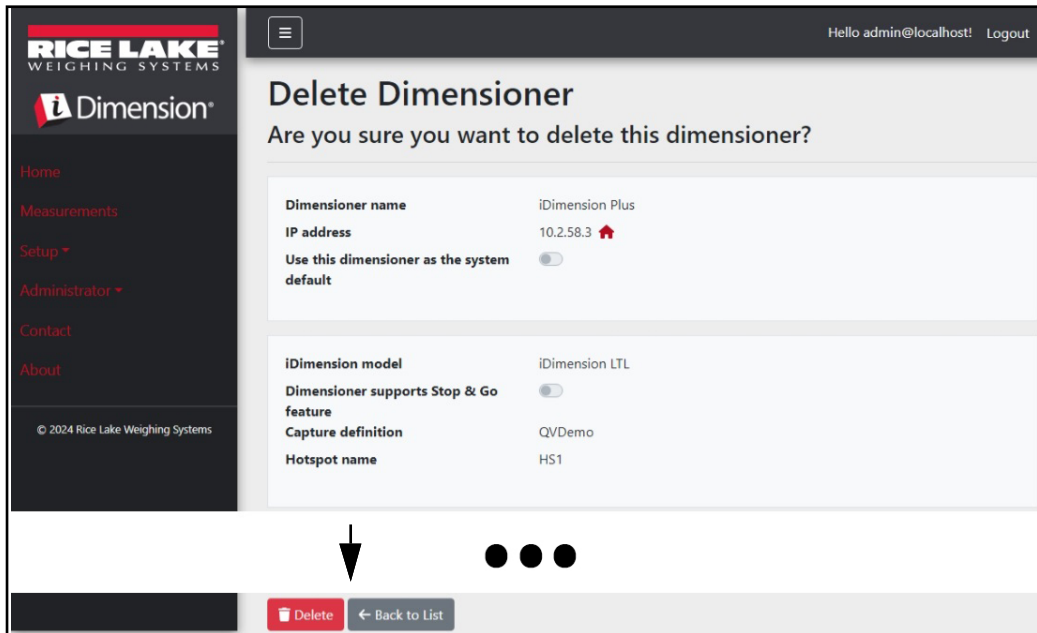

Figure 3-22. Delete Dimensioner Page

3.4.2 Scale Setup and Configuration

This section provides steps to set up and configure scales.

3.4.2.1 Create a New Scale

1. Select **Setup > Scales** in the menu to access the scale management functions.
2. Select the **+ Create New** button to add a new dimensioner to the system.

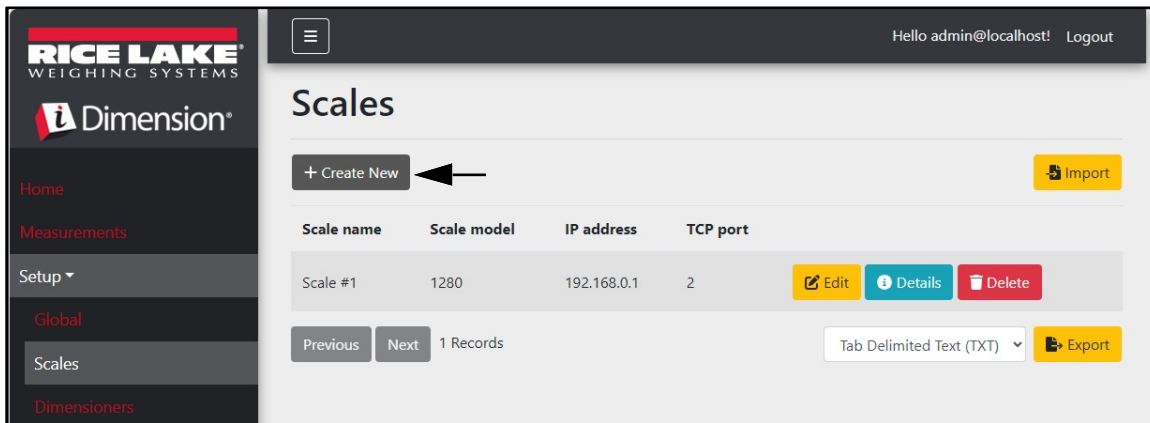

Figure 3-23. Scales Page with + Create New Identified

3. **Create Scale** page displays.
4. Configure the following parameters:
 - **Scale Name:** Enter the desired name for scale.
 - **Scale Type:** Select the type of indicator attached to the scale: 1280, 880, 680 or Dini DFW.
 - **IP Address:** Configure the IP Address assigned to the indicator. For example, 192.168.0.15.
 - **TCP Port:** The TCP port used by indicator attached to the scale; Typically 10001.
5. Select **+ Create** button.

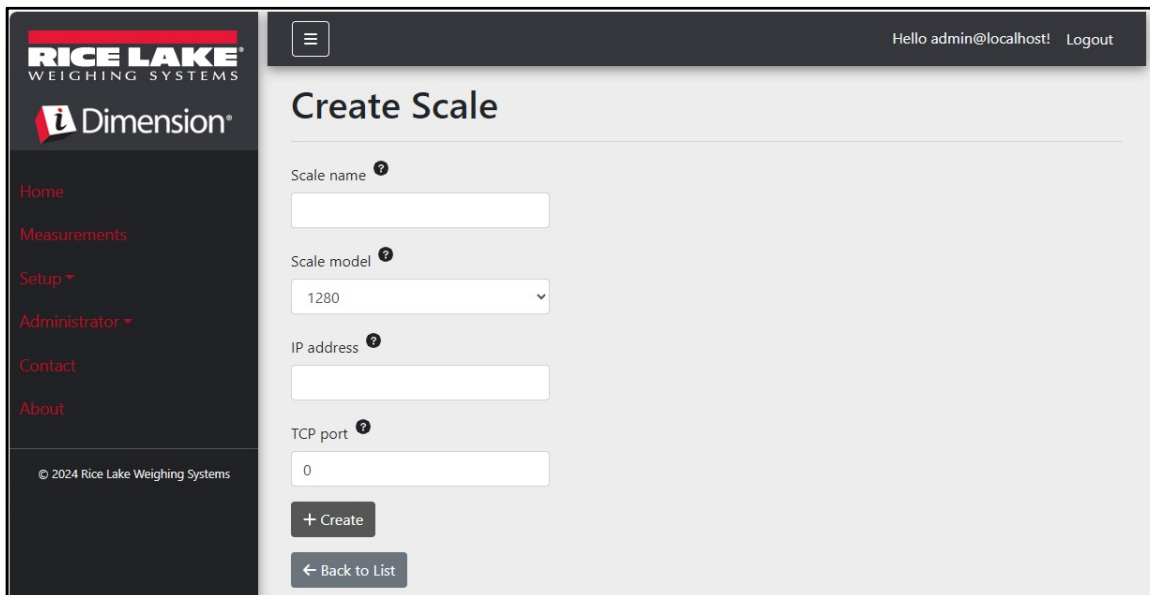

Figure 3-24. Create Scale Page

6. The Scales page displays with the new Scale listed.

3.4.2.2 Scale Configuration and Management

Edit an Existing Scale

1. Select the **Setup > Scales** link in the menu to access the scale management functions.
2. Select **Edit**.

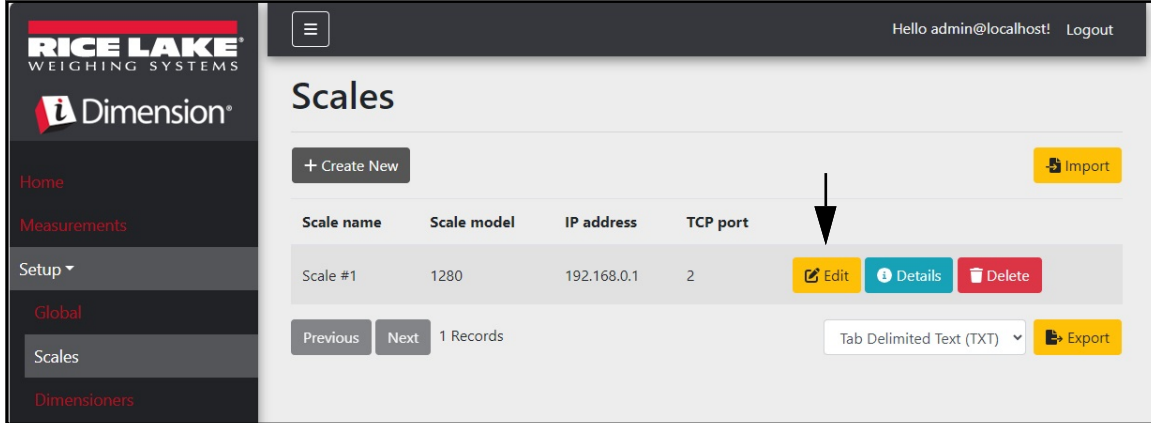

Figure 3-25. Scale Page with Edit Identified

3. **Edit Scale** page displays.
4. Make the desired changes.
5. Select the **Save** button to commit the changes or **Back to List** button to return to the **Scales** view.

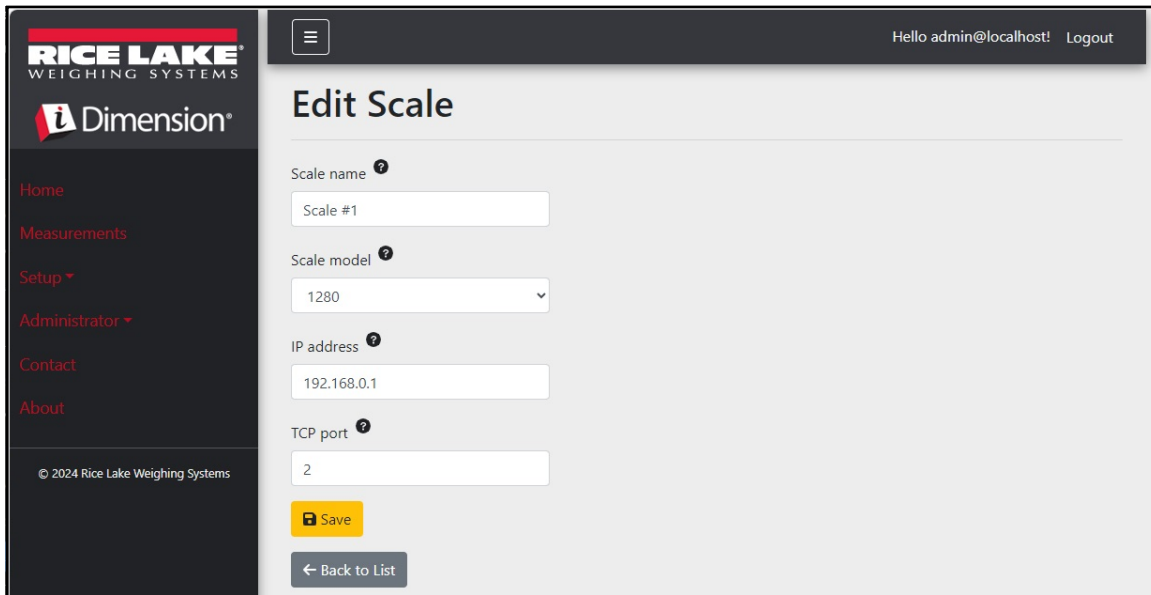

Figure 3-26. Edit Scales Page

View Details of an Existing Scale

- 1. Select the **Setup > Scales** link in the menu to access the scale management.
- 2. Select **Details**.

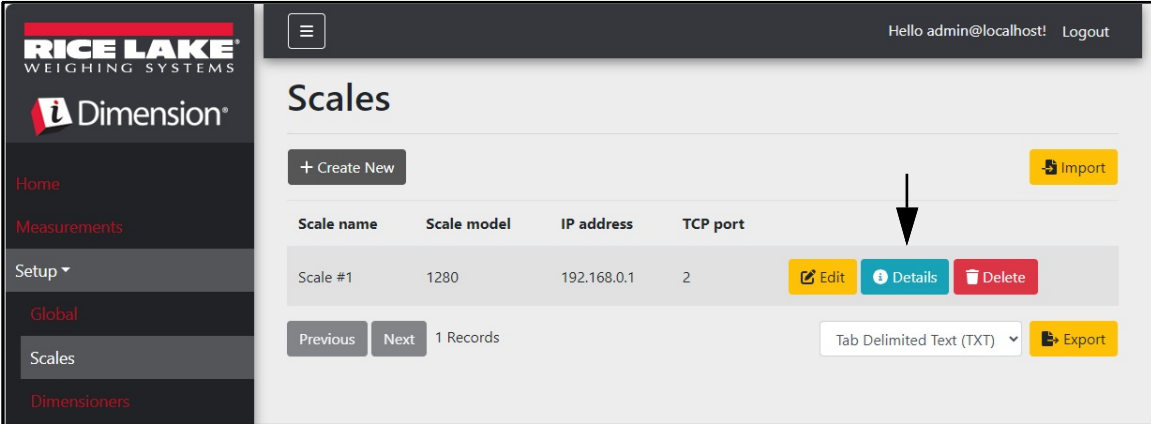

Figure 3-27. Scales Page with Details Identified

- 3. **Scale Details** page displays.
- 4. Select **Edit** button to edit the scale (see page 50) or **Back to List** to return to the **Scales** view.

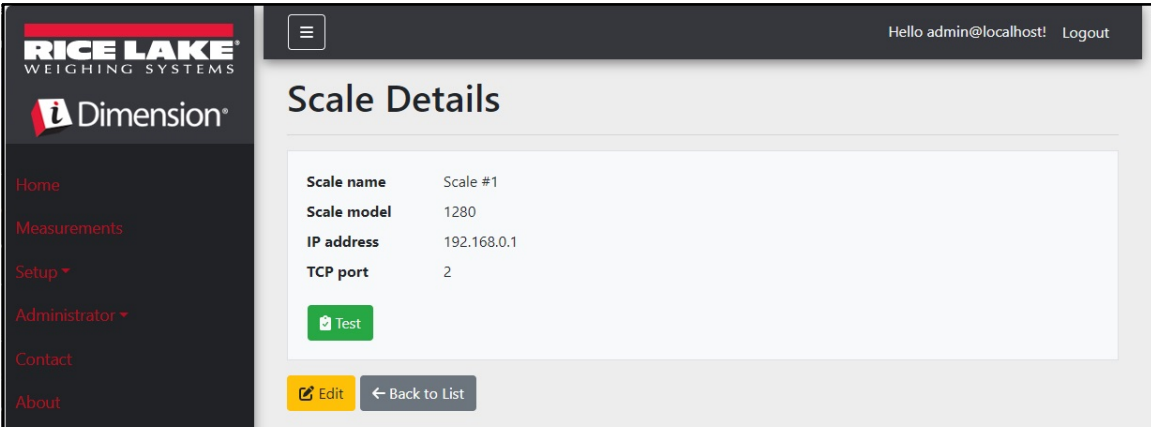

Figure 3-28. Scale Details Page

Delete a Scale

1. Select the **Setup > Scales** link in the menu to access the scale management.
2. Selected **Delete**.

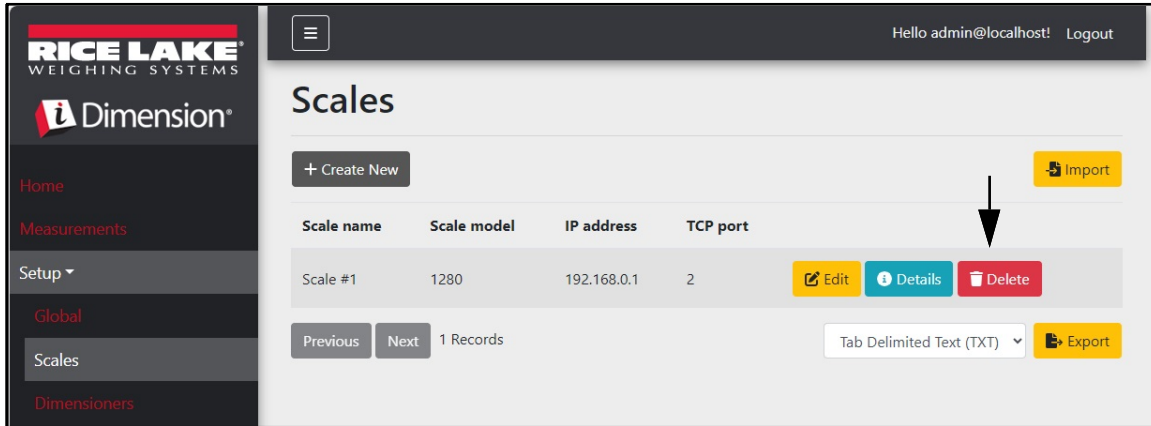

Figure 3-29. Scales page with Delete Identified

3. The **Delete Scale** page displays.
4. Select **Delete**.
5. The system prompts to confirm the delete operation prior to deleting the scale.
6. Select **Delete** to remove scale or **Back to List** to return to the **Scales** view.

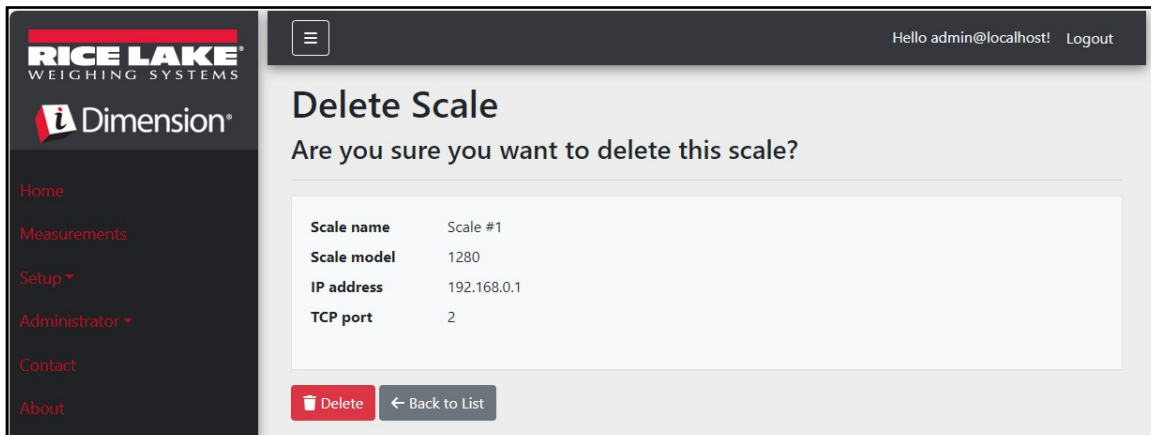



Figure 3-30. Delete Scale Page

3.4.3 Forklift Setup and Configuration

This section provides forklift set up and configuration information.

 **NOTE:** If using Stop and Go feature in the iDimension LTL and one offset measurement is used for every forklift, the forklift database is not required. Configure iDimension LTL QubeVu Manager firmware under capture definitions with appropriate values.

 **NOTE 2:** If using the iDimension Forklift Database for forklift management, open the appsettings.PRODUCTION.json file created in [Section 2.3.1 on page 20](#). Next, configure the parameter "EnableRemoteForkliftApiLink" as "true".

```
"ForkliftOptions": {
  "EnableRemoteForkliftApiLink": true,
  // DO NOT USE 127.0.0.1 or localhost for the address. Use a valid, routable IP address.
  "RemoteForkliftApiAddress": "http://localhost:5050/",
  "MaxCacheTimeoutHours": 24,
  "CacheTimeoutHours": 8,
  // the max number of cached forklifts
  "MaxCacheSize": 100
}
```

Figure 3-31. EnableRemoteForkLiftAPI Link Parameter

3.4.3.1 Create a New Forklift

1. Select the **Setup > Forklifts** link in the menu to access the forklift management functions. The Forklift Details page displays.
2. Select **+ Create New** from the Configuration menu.

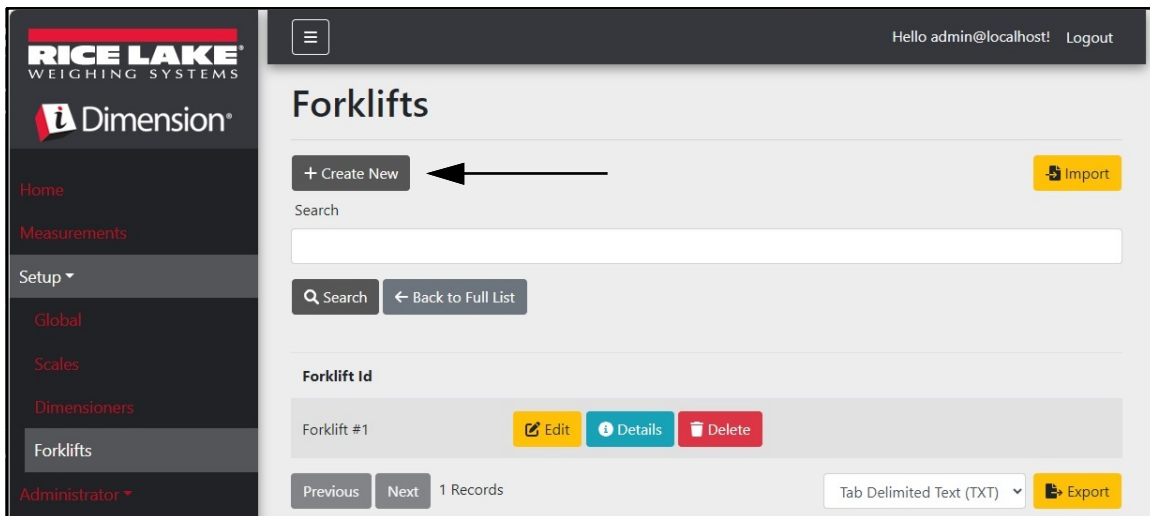

Figure 3-32. Forklift Page with + Create New Identified

3. The **Create Forklift** page displays.
4. Configure the following parameters:
 - **Forklift Id:** Configure the desired alphanumeric identifier for the forklift.
 - **X Offset:** This read-only field displays the difference from the centerline of the carriage to the centerline of the markers in millimeters.
 - **Y Offset:** The distance from the heel of the forks to the center of the markers in millimeters (must be negative value).
 - **Z Offset:** The distance between the top of the forks to the top of the markers in millimeters (must be a positive value).
 - **Marker Distance:** The distance between the center of the markers in millimeters (must be a positive value).
5. Select **+ Create** to save the record and add a new forklift ID into the database or **Back to List** to cancel.

Figure 3-33. Create Forklift Page



NOTE: Figure 3-34 identifies the measurements defined in the forklift database once a bracket has been installed. The values below are entered into the forklift database in mm.



NOTE: Contact the factory for values used on Rice Lake CLS scales with brackets and Universal Brackets with other scale manufacturers.

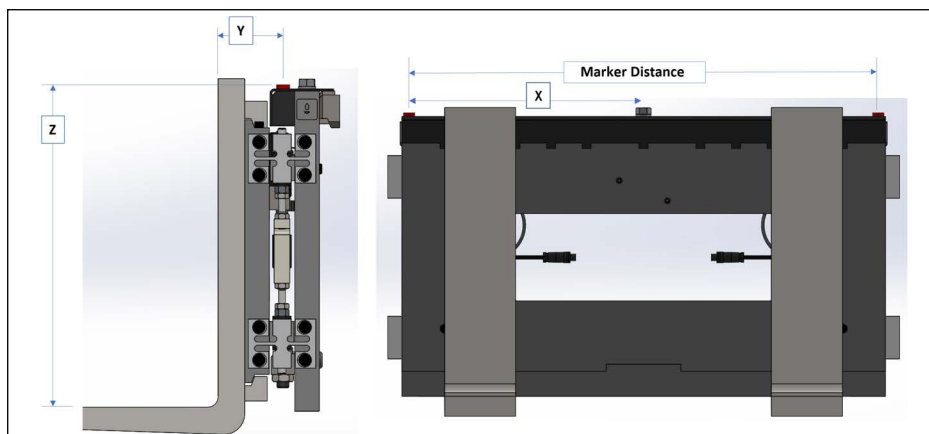

Figure 3-34. Carriage Measurement Diagram

3.4.3.2 Forklift Configuration and Management

Edit an Existing Forklift

1. Select the **Setup > Forklifts** link in the menu to access the forklift management.
2. Select **Edit** from the Configuration menu.
3. Select the **Edit** button in the table to edit the associated forklift.

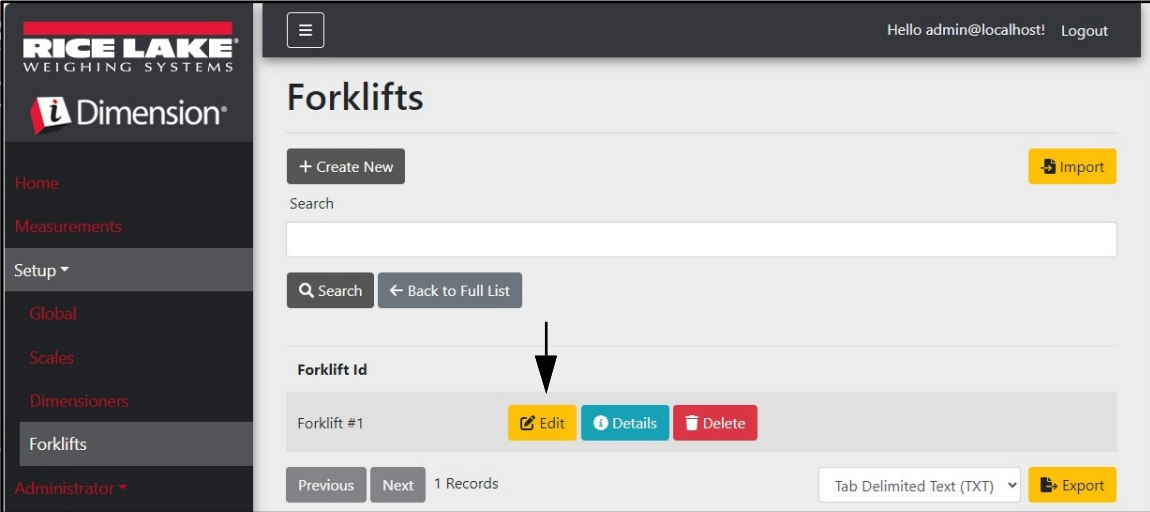

Figure 3-35. Forklifts Page with Edit Button Identified

4. The **Edit Forklift** page displays.
5. Make the desired changes.
6. Select the **Save** button to commit the changes, or select the **Back to List** button to return to the previous page.

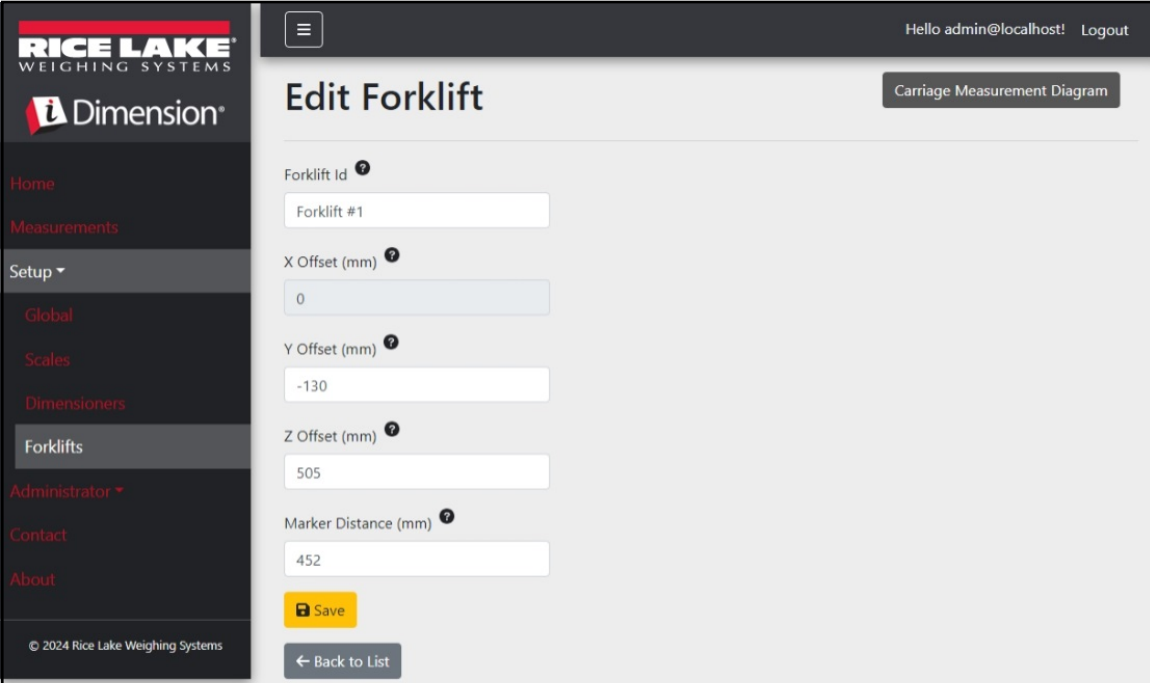

Figure 3-36. Edit Forklift Page

View an Existing Forklift

1. Select **Setup > Forklifts**.
2. Select **View** from the Configuration menu.

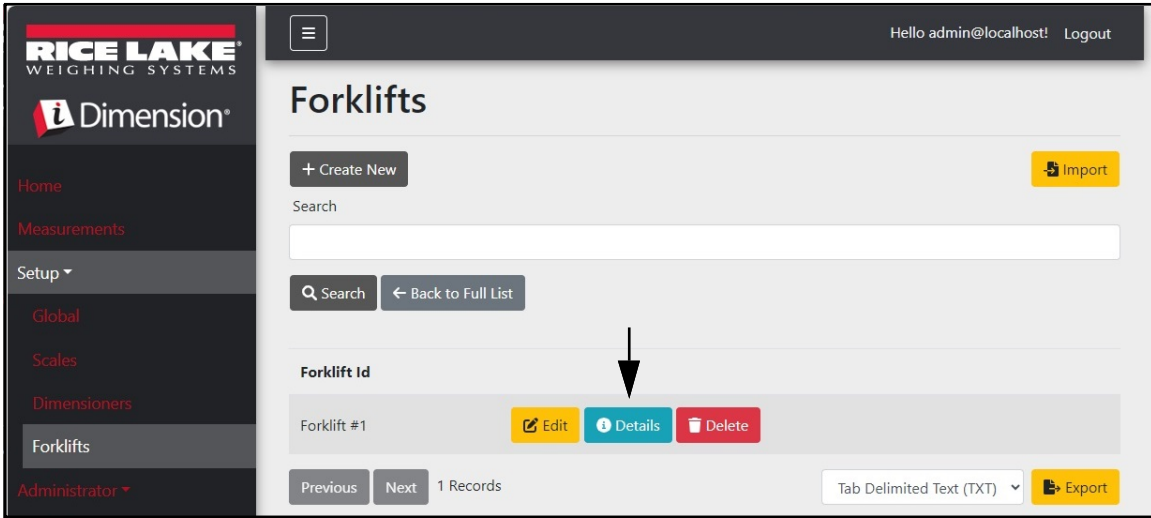

Figure 3-37. Forklifts Page with Details Button Identified

3. The **Forklift Details** page displays.
4. Select **Details** for the associated forklift.
5. Select **Edit** or to modify the forklift or **Back to List** to return to the previous page.



NOTE: See table below for values corresponding to the forklift details.

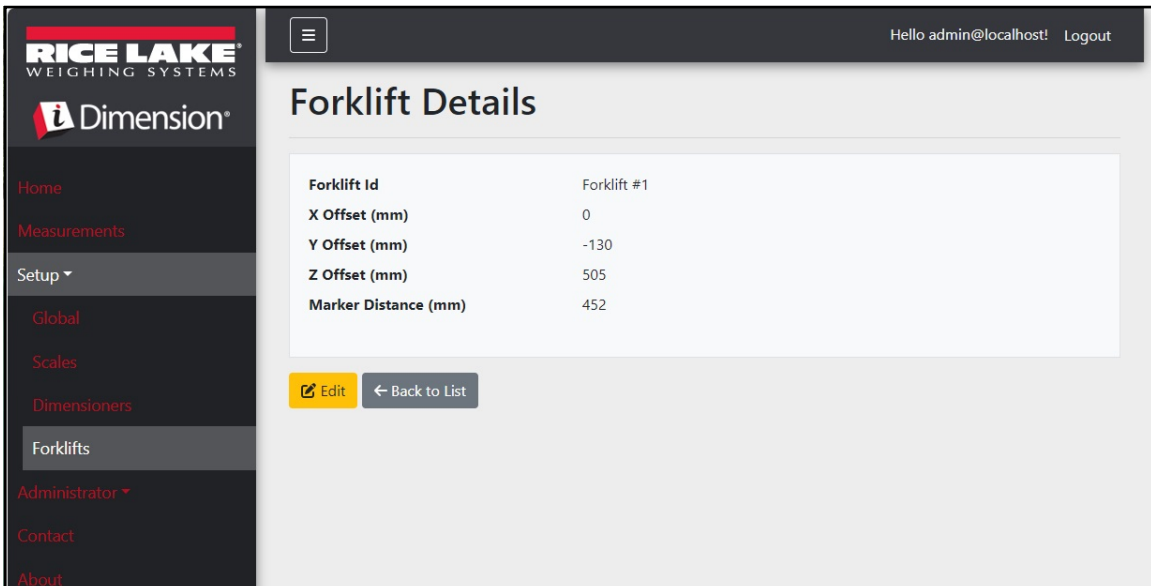

Figure 3-38. Forklift Details Page

Delete a Forklift

- 1. Select the **Setup > Forklifts** link in the menu to access the forklift management.
- 2. Select **Delete** from the Configuration menu.

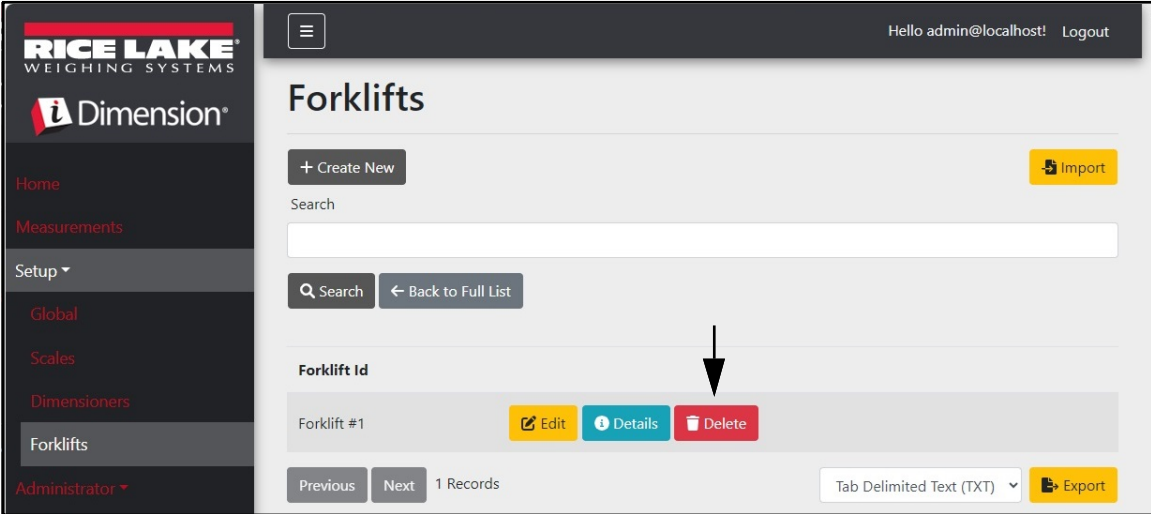

Figure 3-39. Forklifts Page with Details Button Identified

- 3. The **Delete Forklift** page displays.
- 4. Select the **Delete** button to proceed or **Back to List** to return to the previous page.

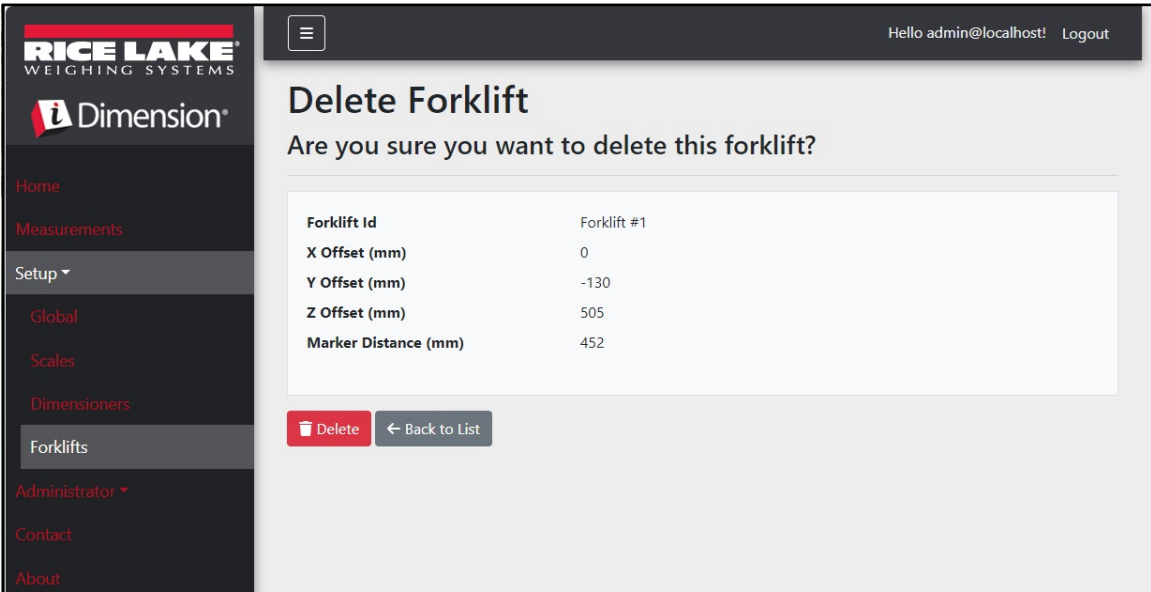

Figure 3-40. Delete Forklift Page

3.5 Global Setup and Configuration

This section provides steps to set up and configure dimensioner data output.

3.5.1 Access Setup items:

1. Select **Setup > Global** in the menu to access the system wide settings.
2. Select the following buttons for the menus:
 - Image Annotation ([Section 3.5.2](#))
 - Image Composition ([Section 3.5.3](#))
 - User Defined Fields ([Section 3.5.4 on page 61](#))
 - Primary and Secondary FTP Upload ([Section 3.5.5 on page 61](#))
 - SMB File Copy ([Section 3.5.6 on page 63](#))
 - SFTP Upload ([Section 3.5.7 on page 65](#))
 - REST API ([Section 3.5.8 on page 66](#))
 - Label Printing ([Section 3.5.9 on page 67](#))
 - Capture Complete View ([Section 3.5.10 on page 68](#))
 - System Notifications ([Section 3.5.11 on page 69](#))
 - Volumetric Conversion ([Section 3.5.12 on page 70](#))
 - Remote I/O ([Section 3.5.13 on page 71](#))
 - Shipping Method Analyzer ([Section 3.5.14 on page 72](#))
 - Scanner Trigger Service ([Section 3.5.15 on page 73](#))
 - Scale Settings ([Section 3.5.16 on page 73](#))
 - Freight Size Configuration ([Section 3.5.17 on page 74](#))

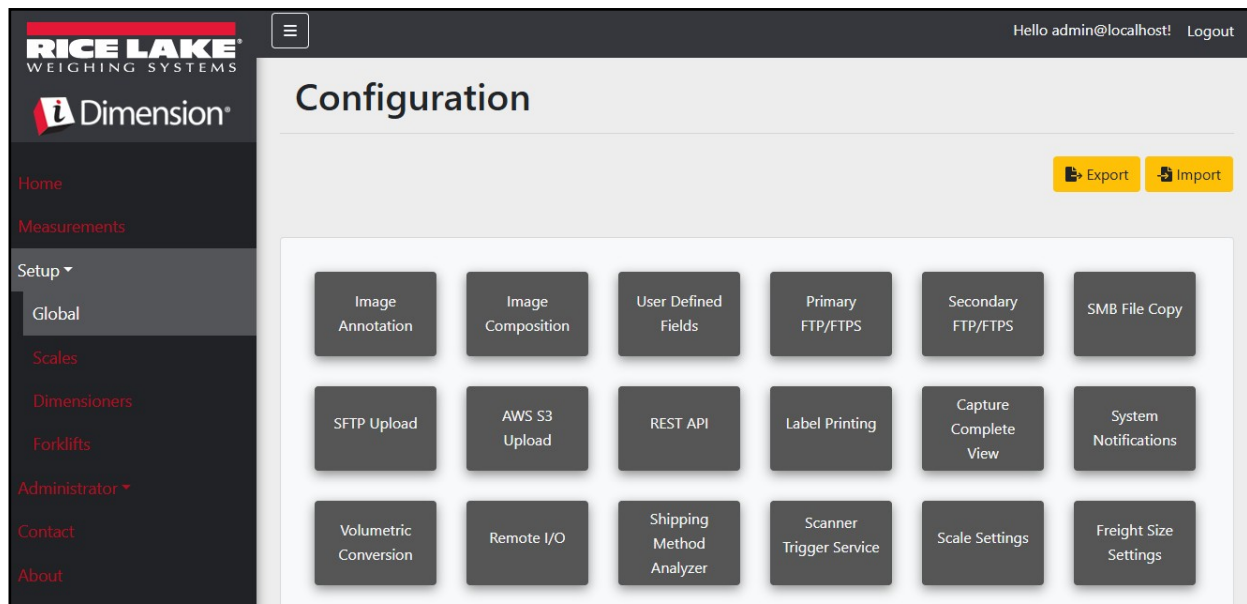

Figure 3-41. Configuration Page

3.5.2 Image Annotation

These parameters configure how Image Annotation is performed.

1. Select **Setup > Global > Image Annotation**.
2. The **Image Annotation Configuration** page displays ([Figure 3-31 on page 53](#)).
3. Configure the following parameters:
 - **Annotation Font Size:** Set the size of the font used to annotate the image. Configured between 10 and 32.
 - **Do not resize the annotated images:** If resizing and this enabled parameter is enabled, it resizes the composite image after it generates. It is recommended to enable this when storing individual images.
 - **Annotation image width:** The maximum width of the annotated image. Configured between 200 - 3000 pixels.
 - **Annotation Image Quality:** Configures image quality. Configure between 10 (poor) - 100 (highest). Use trial and error to determine the preferred balance between quality and file size.
 - **Layout Style:** Rice Lake (image on top with bottom annotations), CubiscanV1 (fixed data set with annotations in corners) or CubiscanV2 (fixed data set with annotations in corners).



NOTE: *CubiscanV1 and V2 provide the same data, however the arrangement is slightly different.*

- **Include Dimensioner Name:** Enable toggle to include dimensioner name in image annotation.
- **Include Pro Number/Manifest Number:** Enable to include pro or manifest number in image annotation.
- **Include Capture Id:** Enable toggle to include capture ID in image annotation.
- **Include Dimensions:** Enable toggle to include dimensions in image annotation.
- **Include Volume (Rice Lake format only):** Enable to include volume in image annotation. This parameter is applicable to Rice Lake format only.
- **Include Weight:** Enable toggle to include weight in image annotation.
- **Include Alibi Storage Number (Rice Lake format only):** Enable toggle to include alibi storage number in image annotation. This parameter is applicable to Rice Lake format only.
- **Include Girth (Rice Lake format only):** Enable toggle include girth metric in image annotation.
- **Include Mode of Operation (Rice Lake format only):** Enable toggle to include operation mode in image annotation.
- **Include Converted Volume (Rice Lake format only):** Enable toggle to include converted volume in image annotation. This parameter is applicable to Rice Lake format only.

4. Select **Save**.

The screenshot displays the 'Image Annotation Configuration' page. On the left is a dark sidebar with the 'RICE LAKE WEIGHING SYSTEMS' logo and 'Dimension' branding, along with navigation links: Home, Measurements, Setup, Administrator, Contact, and About. The main content area has a header with a hamburger menu, the user name 'Hello admin@localhost!', and a 'Logout' link. Below the title is a 'Back to Configuration' button. The configuration options include:

- Annotation Font Size:** A text input field containing '16'.
- Do Not Resize the Annotated Image(s):** A checked toggle switch.
- Annotation Image Width:** A text input field containing '320'.
- Annotation Image Quality:** A slider control ranging from 10 to 100, with the value set near 100.
- Layout Style:** A dropdown menu set to 'Rice Lake' with a 'Layout Example' button.
- Include Dimensioner Name:** An unchecked toggle switch.
- HasProNumber:** A checked toggle switch.
- Include Capture Id:** A checked toggle switch.
- Include Capture Date:** A checked toggle switch.
- Include Dimensions:** A checked toggle switch.
- Include Volume (Rice Lake format only):** An unchecked toggle switch.
- Include Weight:** A checked toggle switch.
- Include Alibi Storage Number (Rice Lake format only):** An unchecked toggle switch.
- Include Girth (Rice Lake format only, if enabled):** An unchecked toggle switch.
- Include Mode of Operation (Rice Lake format only):** An unchecked toggle switch.
- Include Converted Volume (Rice Lake format only):** An unchecked toggle switch.

At the bottom of the configuration area is a 'Save' button.

Figure 3-42. Image Annotation Configuration Page

3.5.3 Image Composition

These parameters control how Image Composition is performed.

1. Select **Setup > Global > Image Composition**.
2. The Image Composition Configuration page displays.
3. Configure the following parameters:
 - **Composition Style:** One parameter is available, Standard.
 - **Composite Image Max Width:** Maximum composite image width in pixels. Configure between 400 and 3000 pixels.
 - **Composition Image Quality:** Configures image quality. Configure between 10 (poor) - 100 (highest). Use trial and error to determine the preferred balance between quality and file size.
4. Select **Save**.

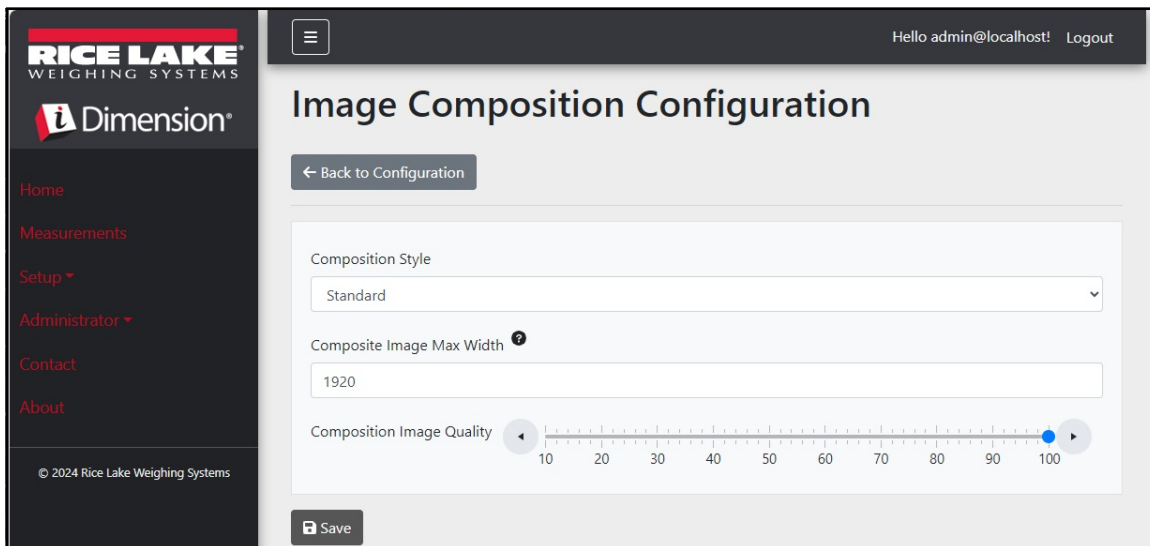

Figure 3-43. Image Composition Configuration Page

3.5.4 User Defined Fields

These parameters allow additional data collect along with the measurement data. If enabled, the fields are added to the Capture view and are saved along with the measurement data.

1. Select **Setup > Global > User Defined Fields**.
2. The User Defined Fields Configuration page displays.
3. Configure the following parameters: **User Field #1 Label** through **User Field #3 Label** with a label/name for up to three additional fields. To disable a field, leave the field blank.
4. Select **Save**.

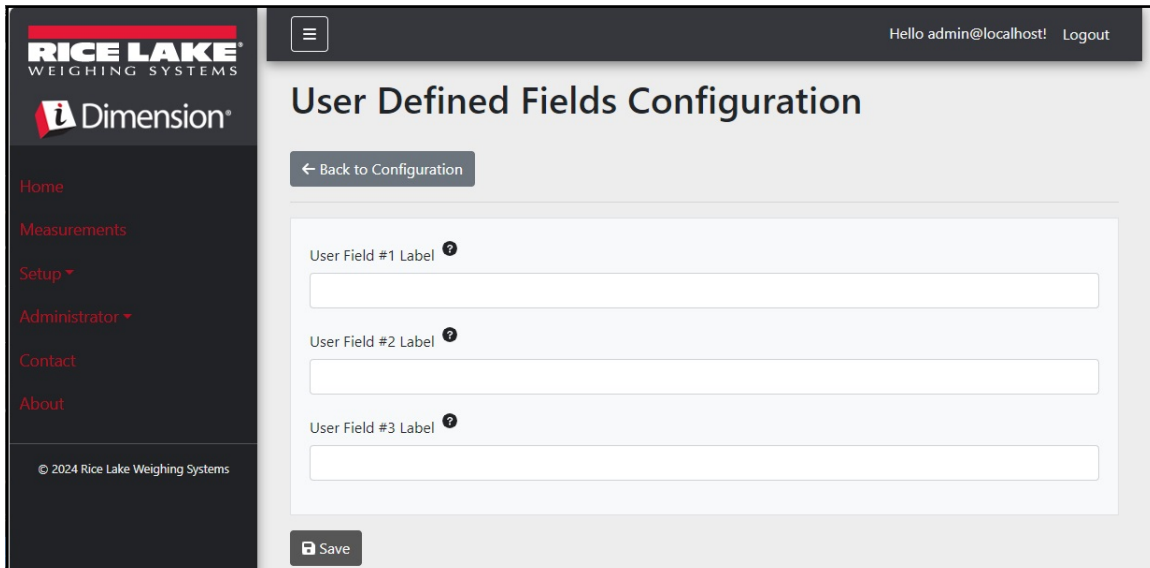

Figure 3-44. User Defined Fields Configuration Page

3.5.5 Primary and Secondary FTP Upload Configuration

These parameters control how File Transfer Protocol (FTP) is configured and performed. This optional process sends images and measurement data to an FTP server on a separate system. Two FTP configurations with the same functionality and appearance are provided, Primary and Secondary. One or both FTP configurations pages may be used.



NOTE: If the *Combine capture images into single image toggle* is enabled in the *Dimensioner configuration* ([Section 3.4.1 on page 42](#)), individual images are compiled into a composite image.

1. Select **Setup > Global > Primary FTP/FTPS** or **Setup > Global > Secondary FTP/FTPS**.
2. The **FTP Upload Configuration** page displays ([Figure 3-45 on page 62](#)).
3. Configure the following parameters:
 - **FTP Upload Enabled:** Enable toggle switch to enable FTP data upload.
 - **FTP Server Address:** Enter the name or IP address of the target server.
 - **Enable FTPS (FTP over SSL):** Enable the toggle switch to activate secure socket layer (SSL) encryption for the connection.
 - **User Name:** Enter the username required for account authentication on the server. This is typically an email address.
 - **Password:** Enter the password used for account authentication.
 - **Use Anonymous Login:** Enable the toggle switch to indicate that the server allows anonymous/un-authenticated connections. When using Anonymous Logins, no password is necessary.
 - **Server Path:** Set as the destination folder path on the server where the uploaded files are placed. This can be left blank.
 - **Publish Image File(s):** Enable toggle switch to publish images to the remote server.
 - **Publish Data File:** Enable toggle switch to publish the data file to the remote server.

- **(Shared) Use Zip Archive Files when Publishing:** Enabled toggle to publish data files as Zip archives.
- **(Shared) Use Lock Files when Publishing:** Enable toggle switch to temporarily write a lock file to the destination so systems reading the files know when write operations are complete. The filename of the lock file mirrors the filename of the actual file being written. This parameter is shared with the FTP Upload configuration.
- **(Shared) Lock File Extension:** Set as the file extension of the lock file. The default is "lck".
- **(Shared) Data File Type:** Set as either Comma Separated Value (CSV), JavaScript object Notation (JSON), Extensible Markup Language XML or tab delimited text (TXT).
- **Image File Type:** Set file type as either JPG (default) or PDF.
- **(Shared) Filename Template:** Select tokens to configure the file name (see [Section 6.1 on page 88](#)).

4. Select **Save**.

Figure 3-45. Primary FTP Configuration Page

3.5.6 SMB File Copy (Windows Only)

These parameters control how Server Message Block (SMB) file operations are performed. This optional process uses SMB to send image and measurement data to a separate Windows system on the network. Additional configuration is necessary to enable this feature.

1. Select **Setup > Global > SMB File Copy**.
2. The Smb File Copy Configuration page displays ([Figure 3-46 on page 64](#)).
3. Configure the following parameters:
 - **Enabled:** Enable toggle switch to enable SMB upload of data.
 - **Server Path:** Enter the name or IP address of the target server.
 - **Number of Retries:** The quantity the iDimmSS attempts to upload data after receiving errors.
 - **Publish Image File(s):** Enable toggle switch to publish images to the remote server.
 - **Publish Data File:** Enable toggle switch to publish the data file to the remote server.
 - **(Shared) Use Zip Archive Files when Publishing:** Enable toggle switch to publish data files in Zip archives.
 - **(Shared) Use Lock Files when Publishing:** Enable toggle switch to temporarily lock files to the destination so that systems reading the files know when write operations are complete. The filename of the lock file mirrors the filename of the actual file being written. This parameter is shared with the FTP Upload configuration.
 - **(Shared) Lock File Extension:** Set as the file extension of the lock file. The default is ".lck".
 - **(Shared) Data File Type:** Set as either Comma Separated Value (CSV), JavaScript object Notation (JSON), Extensible Markup Language XML or tab delimited text (TXT).
 - **Image File Type:** Set file type as either JPG (default) or PDF.
 - **(Shared) Filename Template:** Select tokens to configure the file name (see [Section 6.1 on page 88](#)).
4. Select **Save**.



NOTE: Each time the write fails, an entry is written to the application error log. If the overall attempt fails, nothing further is done. There is no visible indication of error.

Smb File Copy Configuration

← Back to Configuration Test

Enabled

Server Path [?]

Number of Retries [?]

Publish Image File(s)
 Publish Data File
 (Shared) Use Zip Archive Files when Publishing
 (Shared) Use Lock Files when Publishing

(Shared) Lock File Extension [?]

(Shared) Data File Type

Image File Type

(Shared) Filename Template [?]

Available Tokens

%DATE% - The date of the measurement formatted as: yyyyMMdd

%DATE:(optional format specifier)% - The date of the measurement. See manual for format specifiers.

%TIME% - The time of the measurement formatted as: HHmmss (24 hour format)

%TIME:(optional format specifier)% - The time of the measurement. See manual for format specifiers.

%PRO% - The PRO Number/Manifest Number used for the measurement.

%PRO:(optional format specifier)% - The PRO Number/Manifest Number used for the measurement. See manual for format specifiers.

%CAPTUREID% - The capture id for the measurement.

%CAPTUREID:(optional format specifier)% - The capture id for the measurement. See manual for format specifiers.

%IMAGENAME% - The name of the image(s) associated with the measurement.

%IMAGENAME:(optional format specifier)% - The name of the image(s) associated with the measurement. See manual for format specifiers.

%UNIQUEID% - A unique identifier that ensures unique filenames.

%DIMNAME% - The name of the dimensioner associated with the measurement.

%DIMNAME:(optional format specifier)% - The name of the dimensioner associated with the measurement. See manual for format specifiers.

%USER1% - The user field 1 data associated with the measurement.

%USER1:(optional format specifier)% - The user field 1 data associated with the measurement. See manual for format specifiers.

%USER2% - The user field 2 data associated with the measurement.

%USER2:(optional format specifier)% - The user field 2 data associated with the measurement. See manual for format specifiers.

%USER3% - The user field 3 data associated with the measurement.

%USER3:(optional format specifier)% - The user field 3 data associated with the measurement. See manual for format specifiers.

Save

Figure 3-46. SMB Configuration Page

Additional Configuration Required

The iDimension SS application is installed as a standard Windows Service. When using SMB file copy operations, it is necessary to reconfigure the Log On properties of the service.

Typically, the service is setup to “Log On” as a Local System account. Using this feature requires the use of a Windows domain account for the service. The domain or local account must be configured with read/write permissions to the server destination folder. See your local IT administrator for additional details on this configuration.

3.5.7 SFTP Upload (SSH File Transfer Protocol)

These parameters control how Secure File Transfer Protocol (SFTP) is configured and performed. This optional process sends images and measurement data to an SFTP server on a separate system. While FTP and SFTP performs the same function of transferring data to and from a server, an SFTP differs as it uses encryption by default while transferring data.

1. Select **Setup > Global > SFTP Upload**.
2. The SFTP Upload Configuration page displays ([Figure 3-47 on page 66](#)).
3. Configure the following parameters:
 - **SFTP Upload Enabled:** Enable toggle switch to enable SFTP upload of data.
 - **SFTP Server Address:** Enter the name or IP address of the target server.
 - **User Name:** Enter the username used for account authentication on the server. This is typically an email address.
 - **Password:** Enter the password used for account authentication.
 - **Server Path:** Set as the destination folder path on the server where the uploaded files are placed. This can be left blank.
 - **Publish Image File(s):** Enable toggle switch to publish images to the remote server.
 - **Publish Data File:** Enable toggle switch to publish the data file to the remote server.
 - **(Shared) Use Zip Archive Files when Publishing:** Enable toggle switch to publish data files in Zip archives.
 - **(Shared) Use Lock Files when Publishing:** Enable toggle switch to temporarily lock files to the destination so that systems reading the files know when the write operations are complete. The filename of the lock file mirrors the filename of the actual file being written. This parameter is shared with the FTP Upload configuration.
 - **(Shared) Lock File Extension:** Set as the file extension of the lock file. The default is "lck".
 - **(Shared) Data File Type:** Set as either Comma Separated Value (CSV), JavaScript object Notation (JSON), Extensible Markup Language XML or tab delimited text (TXT).
 - **Image File Type:** Set file type as either JPG (default) or PDF.
 - **(Shared) Filename Template:** Select tokens to configure the file name (see [Section 6.1 on page 88](#)).
4. Select **Save**.

Figure 3-47. SFTP Configuration

3.5.8 REST API Configuration

The REST API Configuration page contains one parameter that enables the inclusion of image data in the capture response.



NOTE: For more information regarding REST APIs, see [Section 3.6 on page 74](#).

1. Select **Setup > Global > REST API**.
2. Configure the **Include Image Data in Capture Response** toggle switch to include or exclude image data for REST APIs.
3. Select **Save**.

Figure 3-48. REST API Configuration page

3.5.9 Label Printing Configuration

The Label Printing Configuration enables/disables sending formatted label data to a network attached label printer when a capture is complete.

1. Select **Setup > Global > Label Printing**.
2. Configure the following parameters:
 - **Enabled:** Enable toggle switch to enable label printing.
 - **IP Address:** Enter the name or IP address of the target printer. For example 192.168.0.14.
 - **TCP Port:** Enter the port number used by the label printer.
 - **Number of labels:** Enter the quantity of labels to send to the printer.
 - **Label Format:** The ASCII commands required for the selected printer to generate the label. Measurement data can be inserted by using tokens. The toolbar buttons insert the available tokens when selected.

 **NOTE:** The inserted tokens use the same formatting as the Filename generation tokens (Section 6.1 on page 88). Any non-token text is passed verbatim to the printer.

3. Select **Save**.

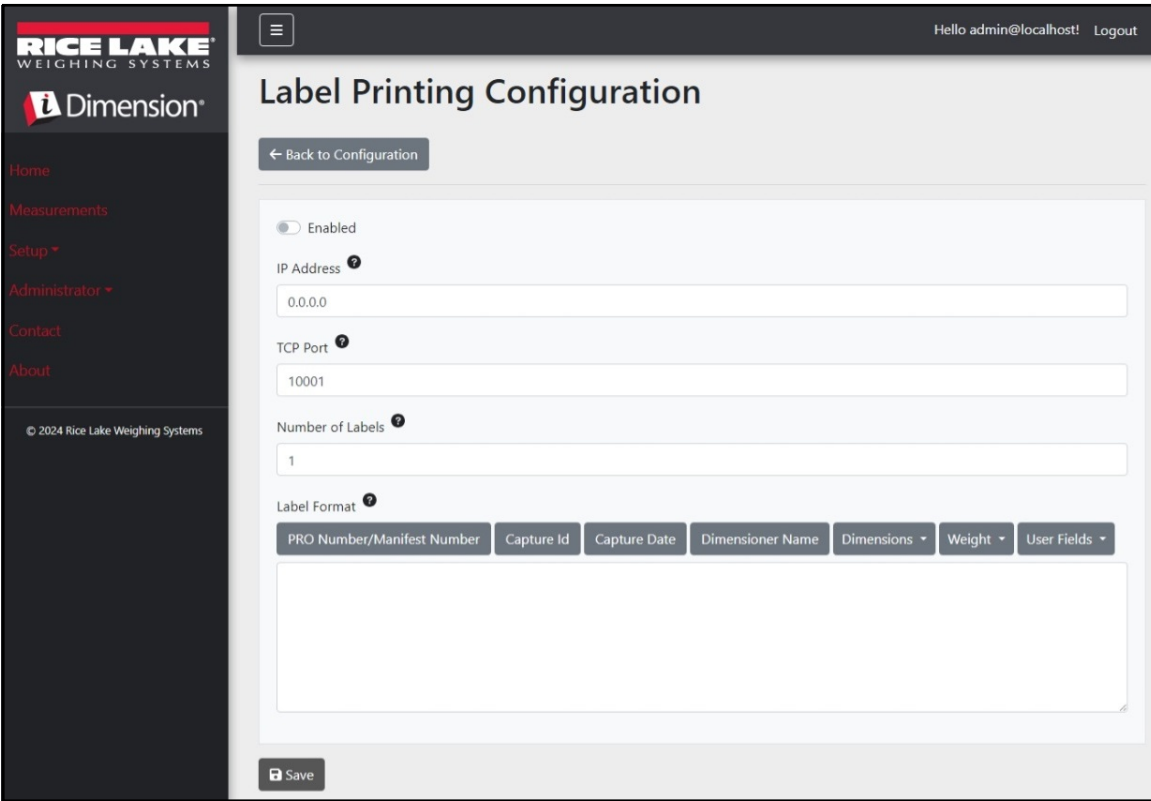

Figure 3-49. Label Printing Configuration Page

3.5.10 Capture Complete View

This allows configuration of the capture complete view.

1. Select **Setup > Global > Capture Complete View**.
2. Configure the following parameters:
 - **QR Code Enabled:** Enable toggle to display a 2-D QR code on the capture complete view.
 - **QR Code Data:** Defines the measurement data embedded in the QR code. Select toolbar buttons to insert tokens. Any non-token text is inserted verbatim into the QR code.



NOTE: The inserted tokens use the same formatting as the Filename generation tokens (Section 6.1 on page 88).

3. Select **Save**.

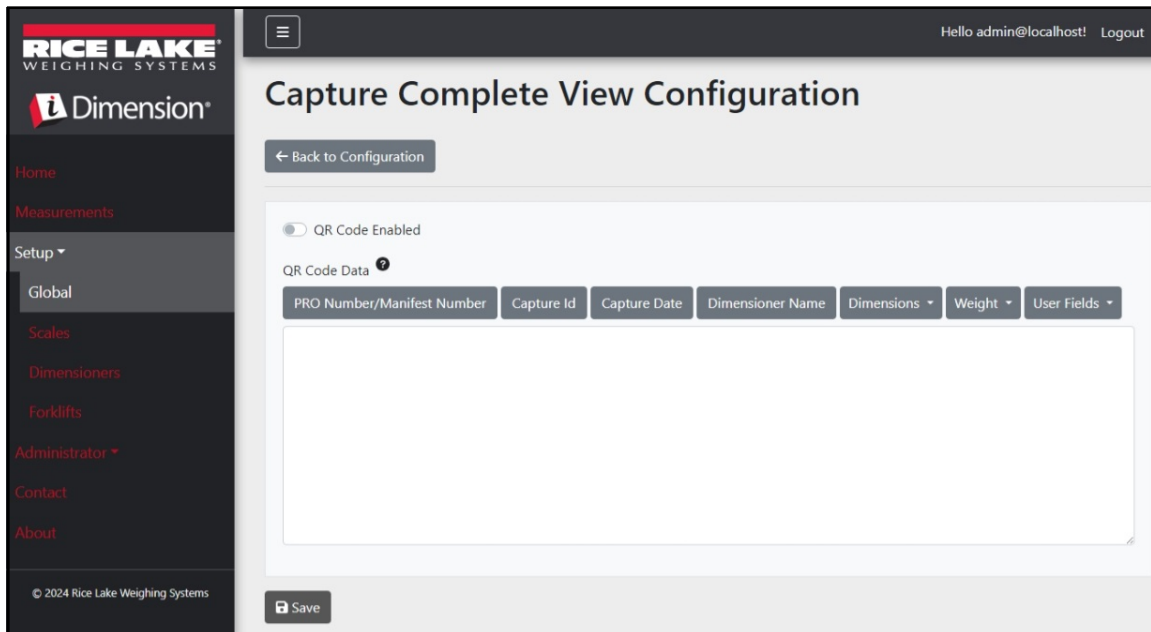

Figure 3-50. Capture Complete View Configuration Page

3.5.11 System Notifications

This allows configuration of various notifications sent by the system in response to events. The notifications are sent via email and require configuration of the email server (see [Section 2.3.2.5 on page 22](#)).

1. Select **Setup > Global > System Notifications**. The System Notifications page displays.
2. Configure the following parameters:
 - **Notifications Enabled:** Enable toggle switch to activate the notification system.
 - **Failed Automatic Export Notification (FTP/SMB) Enabled:** Enable toggle switch to send notifications for errors encountered during the automatic export processes for FTP and/or SMB.
 - **Failed Capture Process Notifications Enabled:** Enable toggle switch to send notifications of errors encountered during the capture process.
 - **Unexpected Error Notifications Enabled:** Enable toggle switch to activate notifications for unexpected errors encountered during various system processes.
 - **Minimum Time Between Notifications (minutes):** Configure between zero (0) and 120. Sets maximum frequency that notifications are sent for each specific classification of notifications.
 - **Email Subject Line:** Sets the subject line of the notification email.
 - **Recipients:** Configures email addresses that receive the notification emails. Separate each address with a semi-colon or a space.
 - **System Id:** The unique system identifier for this specific iDimension SS installation. The default value is the computer's machine name.
 - **System DNS Name/IP Address:** The DNS name or IP Address of the host machine. This adds a hyperlink link to the email that references the system generating the notification. The default value is the computer's machine name.
3. Select **Save**.

The screenshot displays the 'System Notifications Configuration' page. On the left is a dark sidebar with the 'RICE LAKE WEIGHING SYSTEMS' logo and 'iDimension' branding, along with navigation links: Home, Measurements, Setup, Administrator, Contact, and About. The main content area has a header with 'Hello admin@localhost! Logout' and a 'Back to Configuration' button. The configuration fields are as follows:

- Notifications Enabled:** A toggle switch that is currently turned on.
- Failed Automatic Export Notifications (FTP/SMB) Enabled:** A toggle switch that is currently turned off.
- Failed Capture Process Notifications Enabled:** A toggle switch that is currently turned off.
- Unexpected Error Notifications Enabled:** A toggle switch that is currently turned off.
- Minimum Time Between Notifications (minutes):** An input field containing the number '10'.
- Email Subject Line:** An input field containing the text 'iDimension Software Suite System Notification'.
- Recipients:** An empty input field.
- System Id:** An empty input field.
- System DNS Name/IP Address:** An empty input field.

A 'Save' button is located at the bottom left of the configuration area.

Figure 3-51. System Notifications Configuration Page

3.5.12 Volumetric Conversion

This allows configuration of a volume conversion multiplier.

1. Select **Setup > Global > Volumetric Conversion**. The Volumetric Conversion Configuration page displays.
2. Configure the following parameters:
 - **Conversion Unit of Measure**: The name of the converted unit of measure.
 - **Conversion Multiplier**: The multiplier that converts the dimensioner's unit of measure to the target's unit of measure.
3. Select **Save**.

The screenshot shows the 'Volumetric Conversion Configuration' page. The top navigation bar includes the Rice Lake Weighing Systems logo, a hamburger menu, and the user 'admin@localhost!'. The left sidebar contains navigation links: Home, Measurements, Setup, Administrator, Contact, and About. The main content area has a 'Back to Configuration' button and two input fields: 'Conversion Unit of Measure' (empty) and 'Conversion Multiplier' (1.0). Below these are two tables of conversion factors.

Cubic Inches to		Cubic Centimeters to	
ft ³	0.000589	in ³	0.061024
cm ³	16.38700	ft ³	0.000035
m ³	0.000016	m ³	0.000001

A 'Save' button is located at the bottom left of the configuration area.

Figure 3-52. Volumetric Conversion Configuration Page.

3.5.13 Remote I/O

This allows configuration of parameters associated with the Remote I/O hardware and associated functionality.

1. Select **Setup > Global > Remote I/O**.
2. Configure the following parameters:
 - **Placeholder PRO Number/Manifest Number:** Set a placeholder Pro/Manifest number to capture operations that are triggered via Remote I/O hardware.
3. Select **Save**.

 **NOTE:** Select Remote I/O Wiring Diagram to view the wiring information for the Remote I/O hardware.

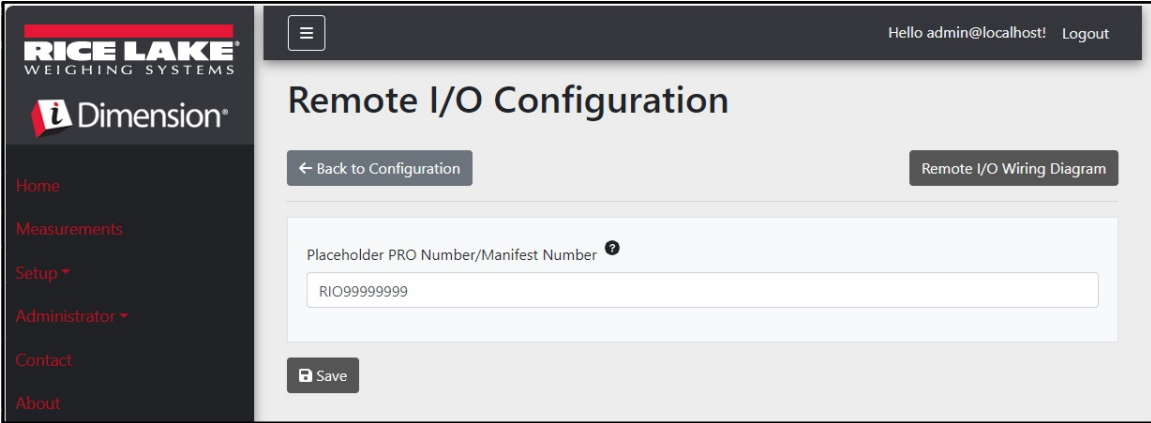

Figure 3-53. Remote I/O Configuration Page

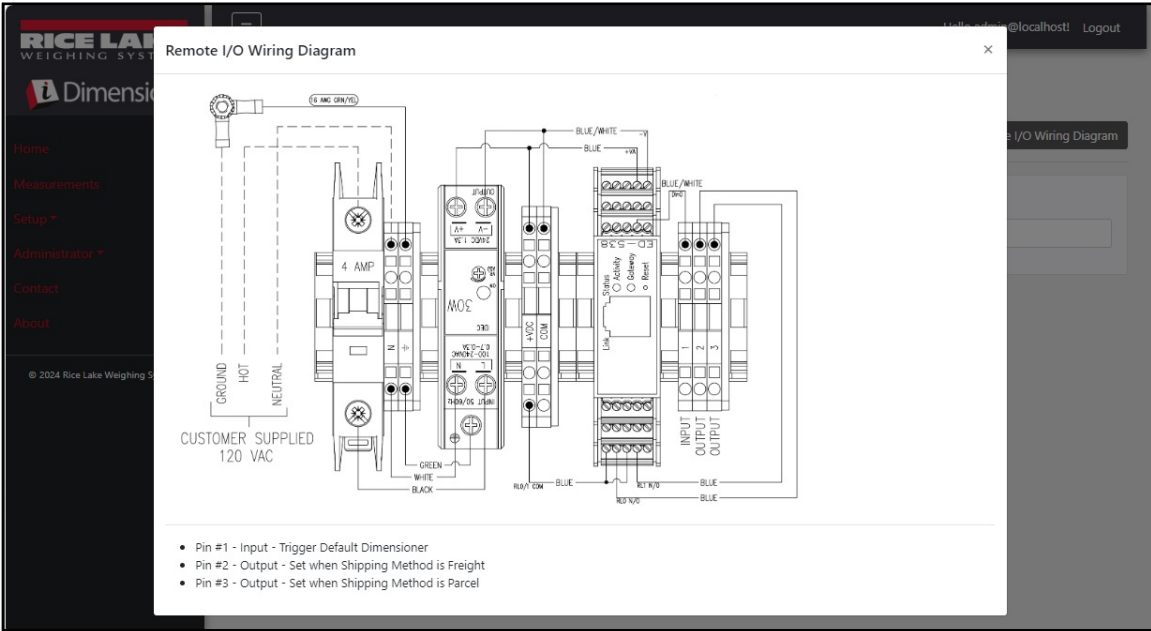

Figure 3-54. Remote I/O Wiring Diagram

3.5.14 Shipping Method Analyzer

This allows specifying a threshold value based on girth or volume to determine if the object scanned should be shipped via Parcel or Freight (oversize or large package exceeding threshold value).

1. Select **Setup > Global > Shipping Method Analyzer**. The Shipping Method Analyzer Configuration page displays.
2. Configure the following parameters:
 - **Girth Analysis Threshold:** The threshold value used to determine if a scanned item should ship parcel or freight. If the calculated value exceeds the threshold, freight shipping is indicated.
 - **Volume Analysis Threshold:** The threshold value used to determine if a scanned item should ship or not. If the calculated value exceeds the threshold the item should not be shipped. The value is set in the configured dimensioner measurement units (for example, cubic inches)
 - **Shipping Analyzer Method:**
 - Girth Analysis 1 and 2: $Girth = (Length + (Width \times 2) + (Height \times 2))$
If the calculated value exceeds the Girth Analysis Threshold, the freight method is indicated and the Remote I/O hardware will energize the digital output associated with the indicated shipping method. In Girth Analysis 1, the length, width, and height units are rounded before being used in the formula. However, in Girth Analysis 2 only the final result is rounded.
 - Volume Analysis: $Volume = (Length \times Width \times Height)$
If the calculated value exceeds the Volume Analysis Threshold, the freight method is indicated and the Remote I/O hardware will energize the digital output associated with the indicated shipping method.
3. Select **Save**.

The screenshot displays the 'Shipping Method Analyzer Configuration' page. The interface includes a sidebar with navigation links: Home, Measurements, Setup (selected), Administrator, Contact, and About. The main content area features a 'Back to Configuration' button and three input fields: 'Girth Analysis Threshold' with the value 164, 'Volume Analysis Threshold' with the value 4000, and a 'Shipping Analyzer Method' dropdown menu currently set to 'Girth Analysis'. A 'Save' button is located at the bottom of the configuration area. The top right of the page shows the user 'Hello admin@localhost!' and a 'Logout' link.

Figure 3-55. Shipping Method Analyzer Configuration Page

3.5.15 Scanner Trigger Service Configuration

The Scanner Trigger Service Configuration contains one parameter that allows a user to scan a barcode and use it as a ProNumber.

! **IMPORTANT:** Disable the Enable Response toggle switch for normal use.

1. Select **Setup > Global > Scanner Trigger Service**. The Scanner Trigger Service Configuration page displays.
2. Configure **Enable Response** toggle switch to activate or deactivate scanner response.
3. Select **Save**.

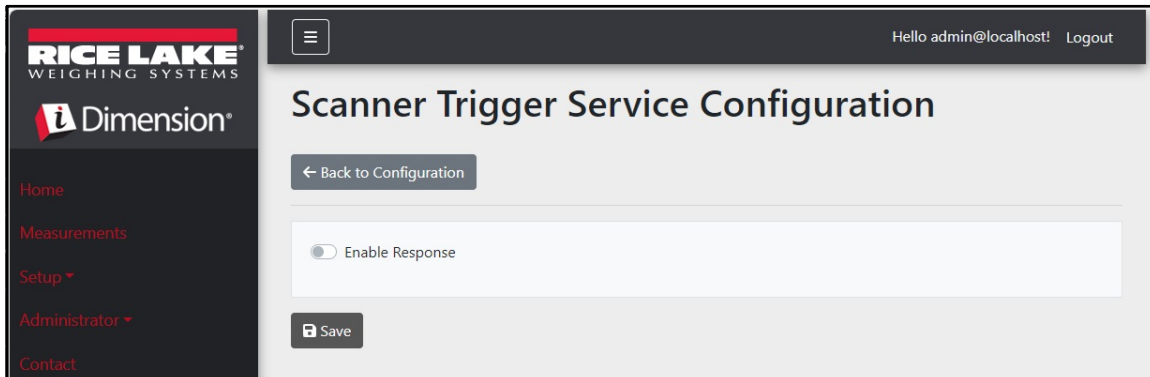

Figure 3-56. Scanner trigger Service Configuration Page

3.5.16 Scale Settings

Scales Settings contains one parameter that sets the position of the decimal place. When Web Real-Time Display and QR codes are used, these function adds the decimal place to the value as per the Decimal Position parameter.

1. Select **Setup > Global > Scale Settings**.
2. Set the Decimal Position as either 0000000, 000000.0, 00000.00, 0000.000, or 000.0000.
3. Select **Save**.

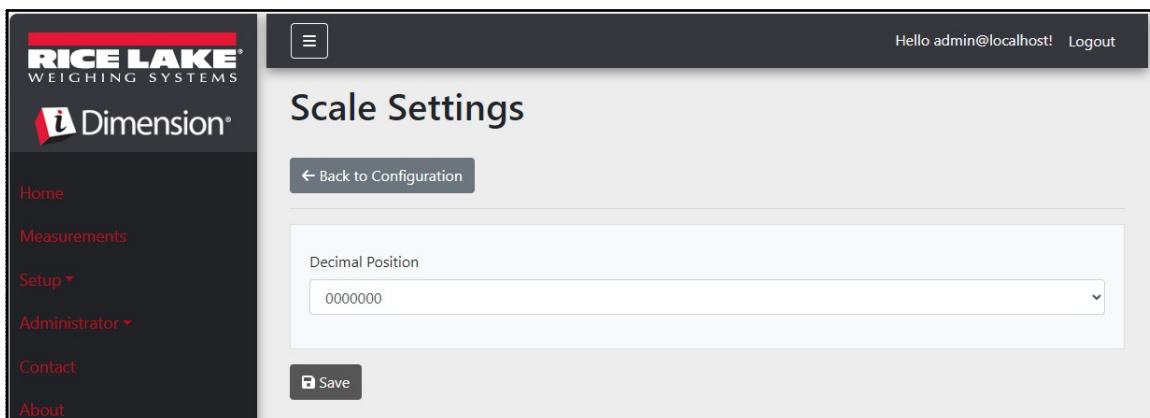
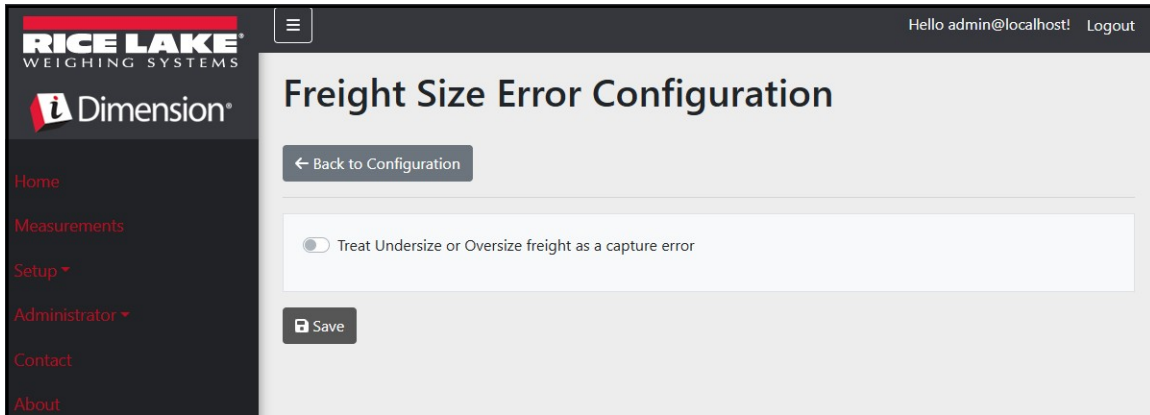

Figure 3-57. Scale Settings Parameter Page

3.5.17 Freight Size Configuration

1. Select **Setup > Global > Freight Size Settings**.
2. Configure **Treat Undersize or Oversize freight as capture error** toggle switch to enable or disable oversize and undersize data being flagged as a capture error.



3.6 About

The about page provide information regarding Software version, Build Date, Copyright and API documentation links.

1. Select the **About** menu item to view the About page.
2. (Optional) Select API links to view the REST API, definition file, or API documentation.

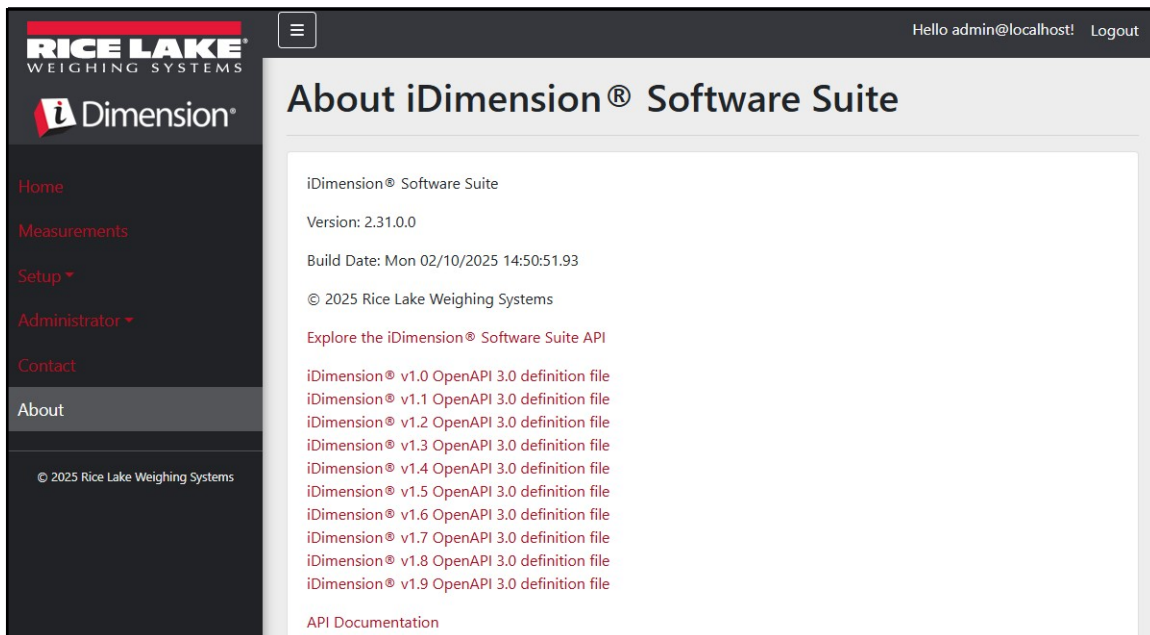

Figure 3-58. About iDimension Software Suite Page

3.6.1 HTTP REST

The application supports access to the system data via a standard REST API. This API can be explored by selecting the link in the About page. Also, API documentation and Open API 3.0 definition files can be downloaded from the About page.

Authentication is accomplished using OAuth2 and bearer tokens as shown in the API declaration.

4.0 Operation

4.1 Capture Measurement Data

The Home view shows all configured dimensioners.

To trigger a capture process on a specific dimensioner:

1. Select the dimensioner to trigger a capture process. The Start Capture view for the dimensioner displays.

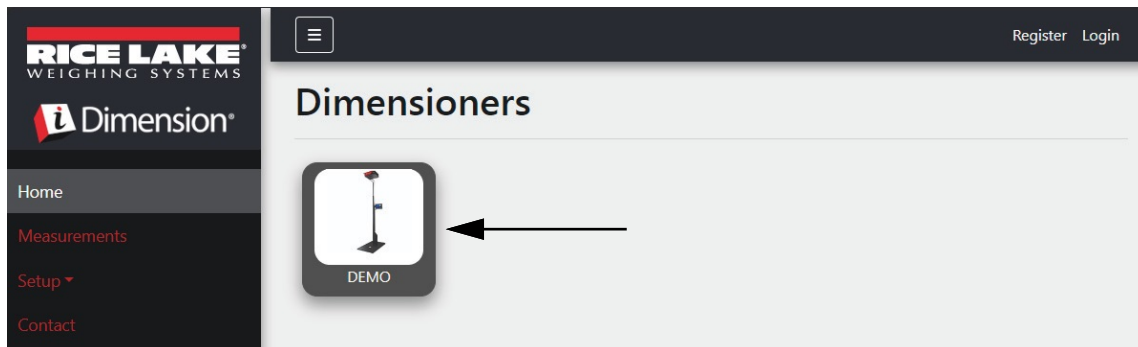

Figure 4-1. Dimensioner Home

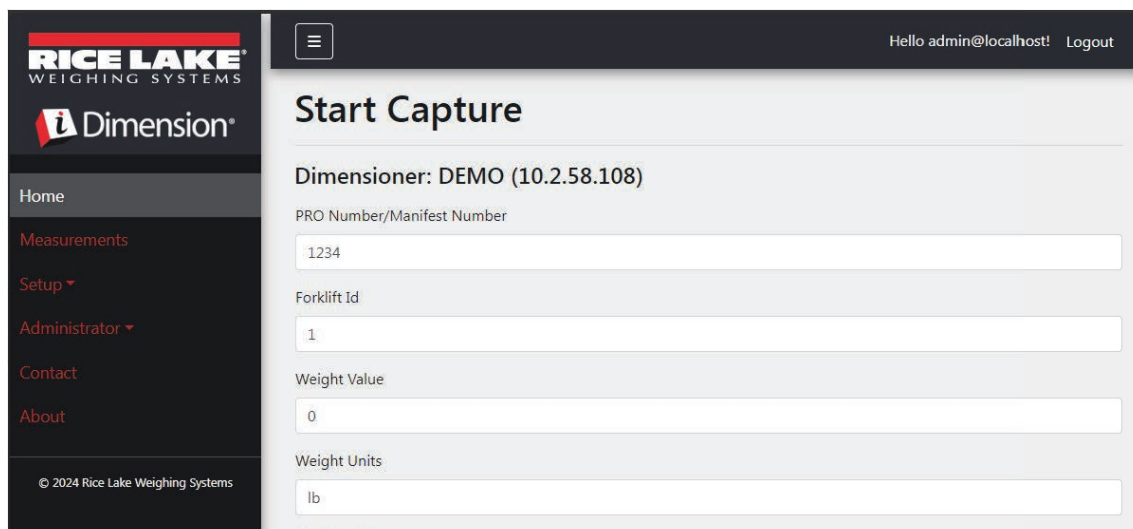

Figure 4-2. Start Capture View

2. Enter the required data:
 - **PRO Number/Manifest Number** - (Required)
 - **Forlift ID** - (Optional)



NOTE: Forklift ID is only shown when connected do a dimensioner that supports Stop and Go functionality and Stop and Go is enabled on selected dimensioner.

- **Weight Value** - Enter weight value of object is dimensioner is configured to manually enter weight (Optional)
- **Weight Units** - Enter weight unit of object (Optional)



NOTE: Weight Value and Weight Units are only shown when Manual Weight entry is enabled on selected dimesioner.

- **Three Optional User Defined Fields** - User Field #1 Label, User Field #2 Label, User Field #3 Label



NOTE: User defined fields are only shown if enabled system-wide.

3. Select the **Capture** button.

4. The dimensioner triggers then the result is Capture Complete Displays.

RICE LAKE
WEIGHING SYSTEMS

iDimension

Home
Measurements
Setup ▾
Administrator ▾
Contact
About

© 2024 Rice Lake Weighing Systems

Hello admin@localhost! Logout

Capture Complete for DEMO (10.2.58.108)

Dimensioner Name	DEMO
Pro Number/Manifest Number	1234
Capture Id	1241
Capture Date	8/6/2024 2:57:03 PM
Mode of Operation	Drop and Clear
Weight	0
Weight Unit	lb
Formatted Display Weight	0 lb
Alibi Storage Number	0
Length	13.00 in
Width	12.20 in
Height	20.40 in
Volume	3235.44 in ³
Converted Volume	3235.44
Oversized	<input type="checkbox"/>
Undersized	<input type="checkbox"/>
Stackable	<input type="checkbox"/>
Operator Name	
Brand	
Location	



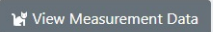

 

Figure 4-3. Capture Complete

5. **Capture Complete** view displays measurement data.
- If image capture is configured, image is displayed below measurement data.
 - If configured, the FTP File Transfer and/or SMB file copy operations takes place after the Measurement Capture operation is successfully completed.
 - QR code sends measurement data to a scanning device.
6. Select the **Back to Dimensioner** to return to configured dimensioners and to perform further capture operations.

4.2 Manage Measurement Data

1. Select the **Measurements** button in the menu to access the Measurement management functions.

The screenshot shows the 'Measurements' page in the Rice Lake Weighing Systems Dimension web application. The sidebar menu on the left has 'Measurements' selected, indicated by a white arrow. The main content area features a search bar, date filters for 'Start Date' and 'End Date' (both set to 8/6/2024), a 'Pro Number (optional)' field, and a 'Mode of Operation' section with radio buttons for 'Drop and Clear', 'Stop and Go', and 'Both' (selected). Below these filters are 'Search' and 'Back to Full List' buttons, and a 'Measurements Report' button. A table displays the search results with columns for 'PRO Number/Manifest Number', 'Capture Date', 'Capture Id', and 'Mode'. Each row includes 'Details' and 'Delete' buttons.

PRO Number/Manifest Number	Capture Date	Capture Id	Mode	
1234	8/6/2024 2:57:03 PM	1241	Drop and Clear	Details Delete
254	8/5/2024 3:16:20 PM	1239	Drop and Clear	Details Delete
3456	8/5/2024 3:13:05 PM	1234	Drop and Clear	Details Delete

Figure 4-4. Measurement Data

2. Use the search function to filter the list of measurement.
3. Enter a partial pro/manifest number, then Select the **Search** button to query the database for matching measurements.
 - The search results display in the table.
 - The table shows a maximum of 20 measurements. Select the **Next** (or **Previous**) button to navigate to additional pages.
4. Select the **Details** to access the measurement details or **Delete** to delete the measurement data.

4.2.1 View a Measurement

Select **Details** in the table to view the measurement data.



NOTE: This view is identical to the Capture Complete view (Figure 4-3 on page 76).

The screenshot shows the 'Measurement Details' page in the Rice Lake Dimension software. The left sidebar contains navigation links: Home, Measurements, Setup, Administrator, Contact, and About. The main content area displays the following data:

Dimensioner Name	DEMO
PRO Number/Manifest Number	1234
Capture Id	1241
Capture Date	8/6/2024 2:57:03 PM
Mode of Operation	Drop and Clear
Weight	0
Weight Unit	lb
Formatted Display Weight	0 lb
Alibi Storage Number	0
Length	13.00 in
Width	12.20 in
Height	20.40 in
Volume	3235.44 in ³
Converted Volume	3235.44
Oversized	<input type="checkbox"/>
Undersized	<input type="checkbox"/>
Stackable	<input type="checkbox"/>
Forklift Id	
Operator Name	
Brand	
Location	

At the bottom of the page, there is a small image of a measurement capture showing a scale and a container with the label '240-XY5'.

Figure 4-5. View Measurement Details

4.2.2 Delete a Measurement

1. Select **Delete** in the table to remove the associated measurement from the system. The system prompts to confirm the delete operation prior to deleting the measurement.
2. Select **Delete** to proceed.

The screenshot shows the 'Delete Measurement' dialog box in the Rice Lake Dimension software. The left sidebar is the same as in Figure 4-5. The main content area displays the following data:

PRO Number/Manifest Number	123456
Capture Id	23676
Capture Date	1/26/2021 3:17:47 PM
Mode of Operation	Drop and Clear
Weight	156.00 g
Length	355.00 mm
Width	80.00 mm
Height	315.00 mm
Volume	8946000.00 mm ³

The dialog asks: 'Are you sure you want to delete this measurement?' and includes a 'Delete' button at the bottom.

Figure 4-6. Delete Measurement

4.2.3 Export Measurements

To export a list of all measurements to a file:

1. Navigate to the Measurements tab.
2. Select the desired file format in the drop down menu at the bottom of the page:
 - Comma Separated Value (*.CSV)
 - JavaScript Object Notation (*.JSON)
 - Extensible Markup Language (*.XML)
 - Tab Delimited Text (*.TXT)



NOTE: A subset of measurements can be exported by using the start date/end date and other filters at the top of the view

3. Select the **Export** button.

The system generates the file then the browser downloads and saves it to the user's default download location.

The screenshot shows the 'Measurements' page in the Rice Lake Weighing Systems Dimension software. The interface includes a sidebar with navigation links: Home, Measurements (highlighted with an arrow), Setup, Administrator, Contact, and About. The main content area features filters for Start Date (8/6/2024), End Date (8/6/2024), Pro Number (optional), and Mode of Operation (Drop and Clear, Stop and Go, Both). A 'Measurements Report' button is visible. Below the filters is a table with the following data:

PRO Number/Manifest Number	Capture Date	Capture Id	Mode	Actions
1234	8/6/2024 2:57:03 PM	1241	Drop and Clear	Details, Delete
254	8/5/2024 3:16:20 PM	1239	Drop and Clear	Details, Delete

At the bottom of the page, there is a 'Previous' and 'Next' button, a '481 Records' indicator, a dropdown menu set to 'Comma Separated Value (CSV)', and an 'Export' button (highlighted with an arrow).

Figure 4-7. Export Measurements

5.0 Administration

5.1 View Failed Scan Data

Select **Administrator > Failed Scans** to access the failed scan management functions. **Failed Scans** dialog displays.

The screenshot shows the 'Failed Scans' interface. On the left is a navigation menu with options: Home, Measurements, Setup, Administrator (selected), Users, System Settings, Log Files, Failed Scans (highlighted), Dimensioner Test, and Contact. The main area has a header with 'RICE LAKE WEIGHING SYSTEMS' and 'Dimension' logo. Below the header, there are filters for 'Start Date' (8/19/2024) and 'End Date' (8/19/2024), and a 'Pro Number (optional)' search field. A 'Search' button and a 'Back to Full List' button are present. The main content is a table with the following data:

Pro Number/Manifest Number	Capture Date	Details
9877	1/27/2021 1:10:19 PM	Details
9874	1/27/2021 1:13:58 PM	Details
987	1/27/2021 1:21:13 PM	Details

Figure 5-1. Failed Scan Screen

5.1.1 Search for Failed Scans

Use the search function to filter the list of failed scans.

1. Enter a partial pro/manifest number.
2. Select the **Search** button to query the database for matching failed scans. The search results display in the table.



NOTE: The table shows a maximum of 20 failed scans. Select the **Next** (or **Previous**) button to navigate to additional pages.

5.1.2 View A Failed Scan

Select the **Details** button in the table to view the failed scan data.



NOTE: This view shows data related to the failed scan as well as any images available from the system cameras.

View failed scan details – Select **Show Device Status Message** to view the actual messages received from the dimensioner.

The screenshot shows the 'Failed Scan Details' interface. On the left is the same navigation menu as in Figure 5-1. The main area has a header with 'RICE LAKE WEIGHING SYSTEMS' and 'Dimension' logo. Below the header, the title 'Failed Scan Details' is displayed. The main content shows the following details:

- Capture Date: 1/27/2021 1:10:19 PM
- Error Message: Capture timeout
- Pro Number/Manifest Number: 9877
- Dimensioner Name: iDim 4K 1.5M
- Forklift Id: (empty)

At the bottom, there is a 'Show Device Status Message' button and a 'Back to List' button.

Figure 5-2. Failed Scan Details

5.2 Access Log Files

When the user is logged in with an Administrator role, the Log Files menu item displays in the main menu.

1. Select **Log Files** to display **Application Logs**.
2. Select a link to show the log files that the system created.

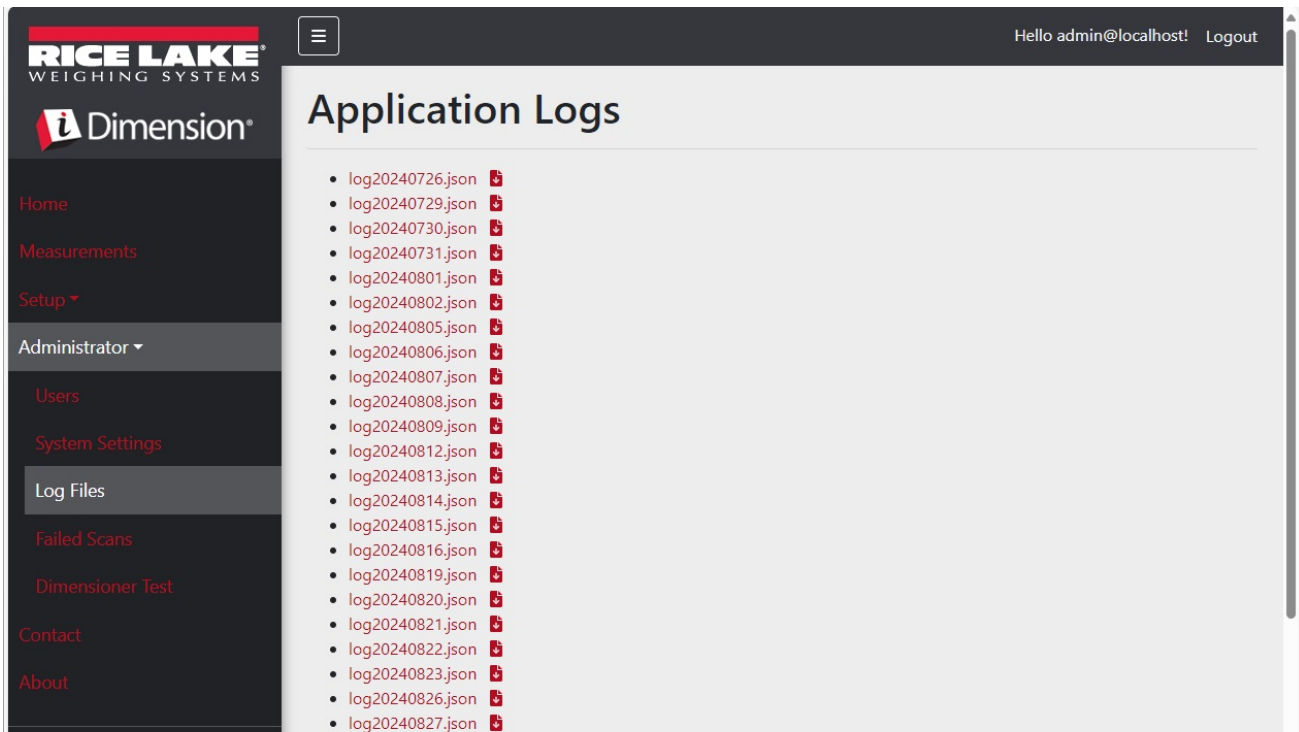

Figure 5-3. Application Log Files



NOTE: The log file is downloaded to the local computer for analysis.

5.3 Access to System Configuration

When the user is logged in with an Administrator role, the System Settings menu (read-only) appears in the menu.

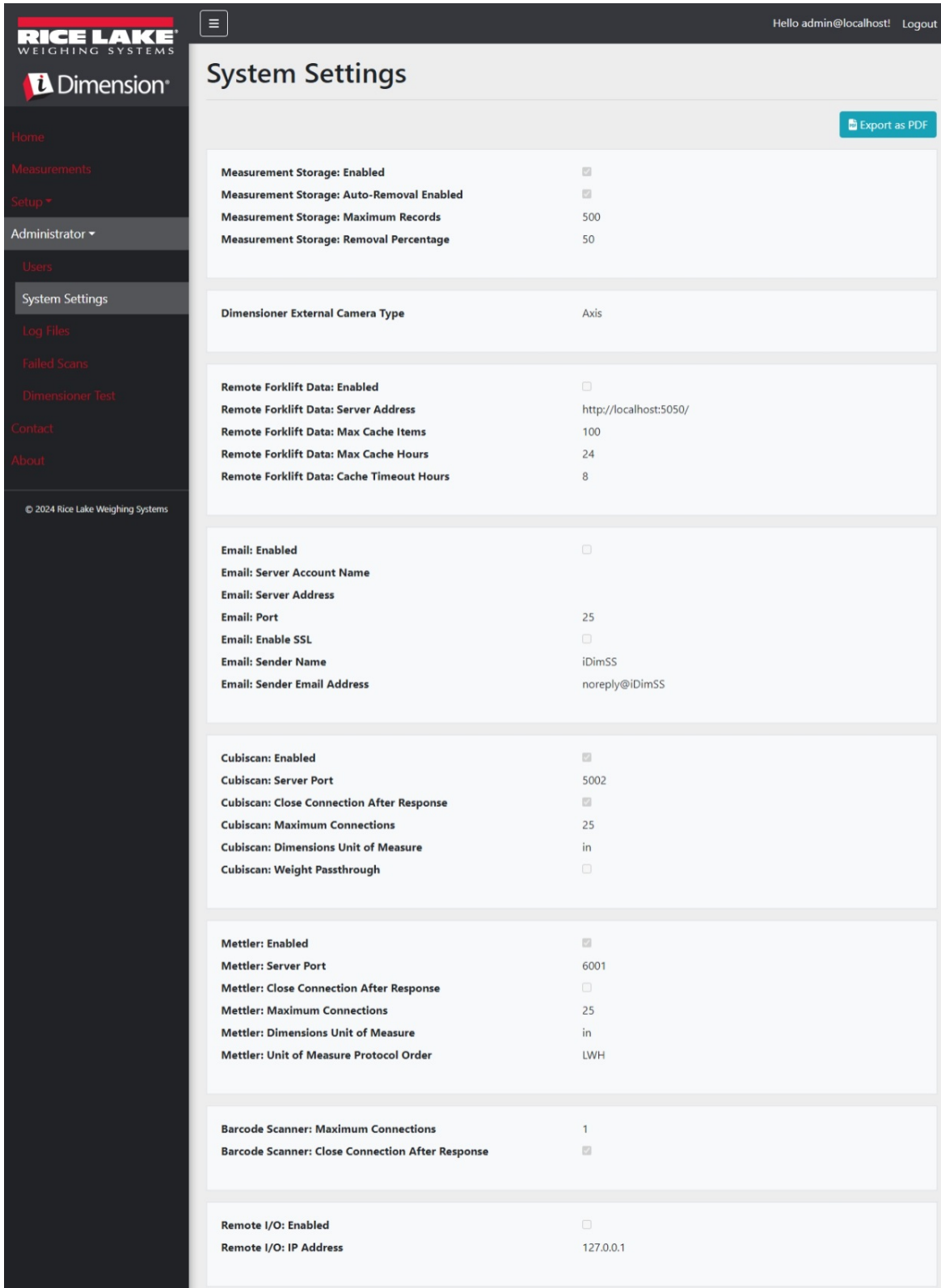

Figure 5-4. System Setting Screen

Category	Setting	Default	Definition
Measurement Storage	Enabled	True/False	Storage is enabled
	Auto-Removal Enabled	True/False	Auto-removal is enabled
	Maximum Records	500	Maximum number of records stored. Configured based on storage space and file size. Integer value. Default value is 500.
	Removal Percentage	50	Percentage of images removed when the count of stored measurements exceeds the maximum allowed. Real/decimal value. Set between 0 and 100. Default value is 50.
Dimensioner	External Camera Type	Axis	
Remote Forklift Data	Enabled	True/False	When set to true, the local forklift views are hidden and all data management functions are done at the remote system. Default value is false.
	Server Address	http://localhost:5050/	URL of the remote system. Typically be similar to: https://RemoteComputerNameOrIpAddress:5051/
	Max Cache Items	100	The maximum number of forklift items that are held in the cache. If additional items are added, older items are purged.
	Max Cache Hours	24	The maximum amount of time that an item is held in the cache regardless if it was recently accessed.
	Cache Timeout Hours	8	Time an item is held in the cache. If the item is accessed, timeout is reset.
Email	Enabled	True/False	Email is enabled
	Server Account Name		Account name used for authentication on the email server; Typically an email address
	Server Address	mail.ricelake.com	Name or IP address of the SMTP email server
	Port	25	Mail server TCP port
	Enable SSL	True/False	Secure sockets layer encryption is enabled when authenticating and sending email messages. Default value is 'true'.
	Sender Name	iDimSS	Friendly/display name of the sender.
	Sender Email Address	noreply@iDimSS	Email address of the sender of the email.
Cubiscan	Enabled	True/False	Cubiscan is enabled. Default value is 'false'.
	Server Port	5002	Port used by the application to listen for incoming connections and requests. Default value is 5002.
	Close Connection After Response	True/False	Application immediately closes connection to external system after sending response. Frees the application to accept a new request. Default value is 'true'.
	Maximum Connections	1	The maximum number of concurrent external connections. Default value is 1.
	Dimensions Unit of Measure	in	The unit of measure for the length, width, height, and volume. Acceptable values are "in" (inches/cubic inches), "cm" (centimeters/cubic centimeters) and "od" (Old Dominion centimeters/cubic feet). If value is not one of the values listed, inches is assumed.
	Weight Passthrough	True/False	Weight value included in the Cubiscan request is passed through to the response message. If false, weight obtained by iDimSS is inserted into the response message.

Table 5-1. System Settings

Category	Setting	Default	Definition
Mettler	Enabled	True/False	Metler is enabled. Default value is 'false'.
	Server Port	6001	Port used to listen for incoming connections and requests. Default value is 6001.
	Close Connection After Response	True/False	Application immediately closes connection to external system after sending response. Frees the application to accept a new request. Default value is 'true'.
	Maximum Connections	1	Maximum number of concurrent external connections. The default value is 1.
	Dimensions Unit of Measure	in	The unit of measure for the length, width, height, and volume. Acceptable values are "in" (inches/cubic inches), "cm" (centimeters/cubic centimeters) and "od" (Old Dominion centimeters/cubic feet). If the value is not one of the values listed, inches is assumed.
	Unit of Measure Protocol Order	LWH	Order that measurements display
Barcode Scanner	Enabled	True/False	Barcode scanner is enabled. The default value is 'false'.
	TCP Port	7001	Port used by the application to listen for incoming connections and requests. The default value is 7001.
	Maximum Connections	1	Maximum number of concurrent external connections. Default value is 1.
	Close Connection After Response	True/False	Application immediately closes connection to external system after sending response. Frees the application to accept a new request. Default value is 'true'.
Remote I/O	Enabled	True/False	Remote I/O is enabled. Default value is 'false'.
	IP Address	0.0.0.0.	IP address of the Remote I/O hardware.

Table 5-1. System Settings (Continued)

5.4 Dimensioner Testing

From the Administrator menu, Select the **Dimensioner Test** link. The following page appears showing the list of configured dimensioners.

1. Select the button for the target dimensioner and the following test page appears.

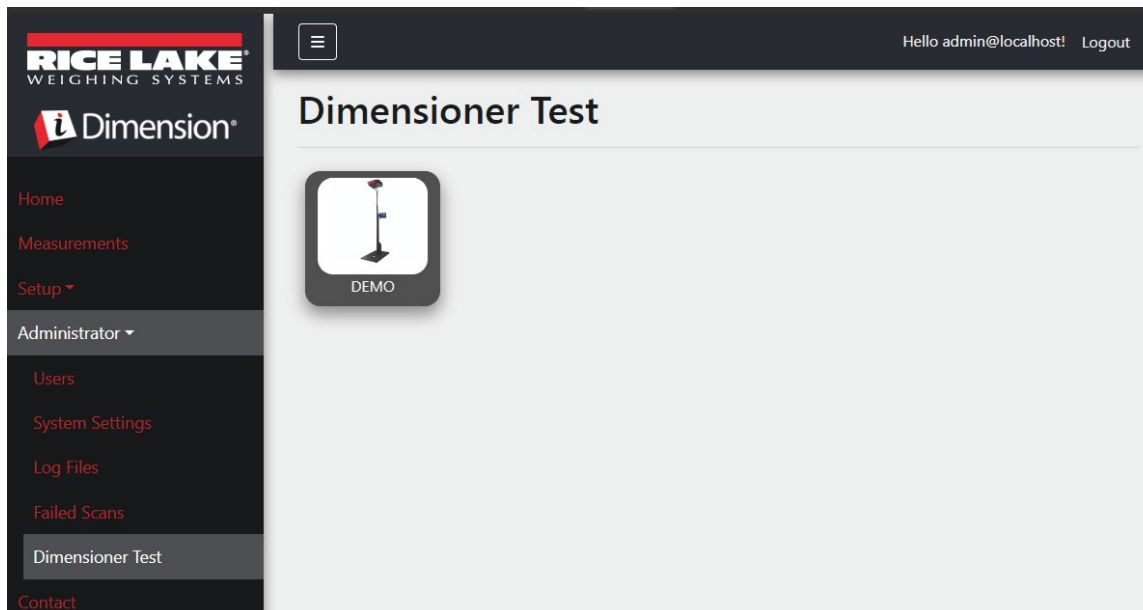

Figure 5-5. Dimensioner Testing

2. Select the **Capture** button to trigger a test of the dimensioner.

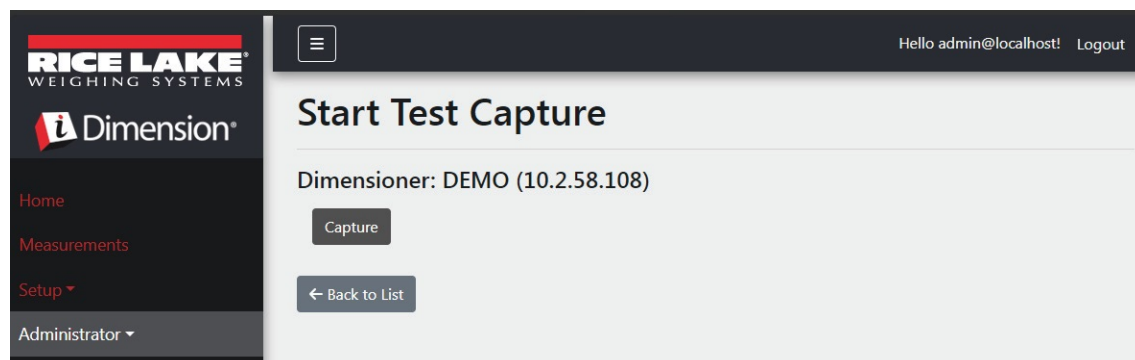

Figure 5-6. Start Test Capture Button

3. The results appear on the Test Complete page.

Capture Id	1242
Capture Date	8/8/2024 10:33:20 AM
Weight	0.00
Length	13.00 in
Width	12.40 in
Height	20.40 in
Volume	3288.48 in ³
Oversized	<input type="checkbox"/>
Undersized	<input type="checkbox"/>

20240808 10:33:06 Scan: 1242 S/N: QVC-3020-01038
13 x 12.4 x 20.4 (in)
PRO Number/Manifest Number: TEST
Length: 13.0 in
Width: 12.4 in
Height: 20.4 in
Weight: 0

← Back to List

Figure 5-7. Test Capture Complete



NOTE: None of the data is stored to the database and the file transfer mechanisms are not triggered. Select the **Back to List** button to return to the list of dimensioners.

5.5 Computer to Computer Communications

The application supports access to the system data via a standard REST API. Authentication is handled using OAuth2 and bearer tokens as shown in the API definition files.



NOTE: If the application is not installed on a machine, API can be accessed.

API information is available from the about screen in Swagger, raw form and PDF.

The screenshot displays the 'About iDimension® Software Suite' page. The left sidebar contains navigation links: Home, Measurements, Setup, Administrator, Contact, and About (selected). The main content area shows the following information:

- iDimension® Software Suite
- Version: 2.31.0.0
- Build Date: Mon 02/10/2025 14:50:51.93
- © 2025 Rice Lake Weighing Systems
- Explore the iDimension® Software Suite API
- Links to OpenAPI 3.0 definition files:
 - iDimension® v1.0 OpenAPI 3.0 definition file
 - iDimension® v1.1 OpenAPI 3.0 definition file
 - iDimension® v1.2 OpenAPI 3.0 definition file
 - iDimension® v1.3 OpenAPI 3.0 definition file
 - iDimension® v1.4 OpenAPI 3.0 definition file
 - iDimension® v1.5 OpenAPI 3.0 definition file
 - iDimension® v1.6 OpenAPI 3.0 definition file
 - iDimension® v1.7 OpenAPI 3.0 definition file
 - iDimension® v1.8 OpenAPI 3.0 definition file
 - iDimension® v1.9 OpenAPI 3.0 definition file
- API Documentation

Figure 5-8. API Information

6.0 Appendix

6.1 Filename Template Tokens/Printer Label Tokens

The tokens listed in this section are applicable when configuring Filename Templates or Label Format in the following pages:

- Primary FTP Configuration ([Section 3.5.5 on page 61](#))
- Secondary FTP/FTPS Configuration ([Section 3.5.5 on page 61](#))
- SMB File Copy Configuration ([Section 3.5.6 on page 63](#))
- STFP Upload Configuration ([Section 3.5.7 on page 65](#))
- Label Printing Configuration Label Format parameters ([Section 3.5.9 on page 67](#))

Token	Description
%DATE%	The date of the measurement formatted as: yyyyMMdd.
%DATE:(optional format specifier)%	<p>The following format specifiers are supported:</p> <ul style="list-style-type: none"> • 'M' –: The month, formatted as a single digit or two digits as appropriate. • 'MM' –: The month, formatted as two digits with a leading zero as appropriate. • 'MMM' –: The abbreviated month as three characters. • 'MMMM' –: The full name of the month. • 'y' –: The year, formatted as a single digit from 0 to 99. • 'yy' –: The year, formatted as two digits from 00 to 99. • 'yyy' –: The year, with a minimum of three digits. • 'yyyy' –: The year, with a minimum of four digits. • 'd' –: The day of the month, from 1 to 31. • 'dd' –: The day of the month, from 1 to 31. • 'ddd' –: The abbreviated name of the day of the week. • 'dddd' –: The full name of the day of the week. <p>NOTE: The format can optionally contain a '-' (dash) character as a separator. Example: For a date of March 15, 2021 with the format: %DATE:yy-MM-dd% would result in this output: 21-03-15</p>
%TIME%	The time of the measurement formatted as: HHmmss (24 hour format).
%TIME:(optional format specifier)%	<p>The following format specifiers are supported:</p> <ul style="list-style-type: none"> • 'h' – The hour, using a 12 hour clock from 1 to 12. • 'hh' – The hour, using a 12 hour clock from 01 to 12. • 'H' – The hour, using a 24 hour clock from 0 to 23. • 'HH' – The hour, using a 24 hour clock from 00 to 23. • 'm' – The minute, from 0 to 59. • 'mm' – The minute, from 00 to 59. • 's' – The second, from 0 to 59. • 'ss' – The second, from 00 to 59. <p>NOTE: The format can optionally contain a ':' (colon) character as a separator. Example: For a time of 3:25:24 PM with the format: %TIME:HH:mm:ss% would result in this output: 15:25:24</p>
%PRO%	The pro or manifest number used for the measurement.
%PRO:(optional format specifier)%	<p>The format specifier is described as follows:</p> <ul style="list-style-type: none"> • Field Width: Justification: Padding Character • Field Width: 1 - 99, the minimum width of the pro number. If the data exceeds the width value, the data is truncated. • Justification: L or R, the data is justified left or right within the field width and padded with the padding character. • Padding Character: One of the following allowed characters: 0, - (dash), or _ (underscore). <p>Example: For a Pro Number of 1234567 and the format of %PRO:14:R:0% would result in this output: 00000001234567</p>
%CAPTUREID%	The capture id for the measurement.

Table 6-1. File Name Template Tokens

%CAPTUREID:(optional format specifier)%	The format specifier is in the format Field Width:Justification:Padding Character , where: <ul style="list-style-type: none"> • Field Width: 1 - 99: the minimum width of the capture id. If the data exceeds the width value, the data is truncated. • Justification: L or R, the data is justified left or right within the field width and padded with the padding character. • Padding Character: One of the following allowed characters: 0, - (dash), or _ (underscore).
%IMAGENAME%	The name of the image(s) associated with the measurement.
%IMAGENAME:(optional format specifier)%	The format specifier is in the format Field Width:Justification:Padding Character , where: <ul style="list-style-type: none"> • Field Width: 1 - 99, the minimum width of the capture id. If the data exceeds the width value, the data is truncated. • Justification: L or R, the data is justified left or right within the field width and padded with the padding character. • Padding Character: One of the following allowed characters: 0, - (dash), or _ (underscore).
%UNIQUEID%	A unique identifier that ensures unique filenames.
%DIMNAME%	The name of the dimensioner associated with the measurement.
%DIMNAME: (optional format specifier)%	The format specifier is described as follows: <ul style="list-style-type: none"> • Field Width: Justification: Padding Character • Field Width: 1 - 99, the minimum width of the name. If the data exceeds the width value, the data is truncated. • Justification: L or R, the data is justified left or right within the field width and padded with the padding character. • Padding Character: One of the following allowed characters: 0, - (dash), or _ (underscore).
%USER1%	Unique user entered data (see Section 4.1 on page 75).
%USER1:(optional format specifier)%	The format specifier is in the format Field Width:Justification:Padding Character , where: <ul style="list-style-type: none"> • Field Width: 1 - 99, the minimum width of the capture id. If the data exceeds the width value, the data is truncated. • Justification: L or R, the data is justified left or right within the field width and padded with the padding character. • Padding Character: One of the following allowed characters: 0, - (dash), or _ (underscore).
%USER2%	Unique user entered data (see Section 4.1 on page 75).
%USER2:(optional format specifier)%	The format specifier is in the format Field Width:Justification:Padding Character , where: <ul style="list-style-type: none"> • Field Width: 1 - 99, the minimum width of the capture id. If the data exceeds the width value, the data is truncated. • Justification: L or R, the data is justified left or right within the field width and padded with the padding character. • Padding Character: One of the following allowed characters: 0, - (dash), or _ (underscore).
%USER3%	Unique user entered data (see Section 4.1 on page 75).
%USER3:(optional format specifier)%	The format specifier is in the format Field Width:Justification:Padding Character , where: <ul style="list-style-type: none"> • Field Width: 1 - 99, the minimum width of the capture id. If the data exceeds the width value, the data is truncated. • Justification: L or R, the data is justified left or right within the field width and padded with the padding character. • Padding Character: One of the following allowed characters: 0, - (dash), or _ (underscore).

Table 6-1. File Name Template Tokens

6.2 Barcode Scanner Service

This allows configuration to enable/disable a service that listens for incoming PRO/Manifest data over TCP that can trigger the dimensioning process for the default scanner.

Enabled: Set to enable the TCP listening server.

TCP Port: The port number used by the listening server. The default value is 7001.

6.3 Error Codes

Scans with error codes are stored in the iDim SS program under the **Administrator > Failed Scans** menu.

Response	Description
Capture timeout	<p>There is no item under the dimensioner. Dimensioner does not see an object. iDimSS software times out if dimensioner does not respond.</p> <ul style="list-style-type: none"> ▶ Solution: Place freight under dimensioner and re-scan. <p>iDimSS is not able to retrieve data from one of the configured sensors/cameras.</p> <ul style="list-style-type: none"> ▶ Solution: <ul style="list-style-type: none"> – Confirm the configured sensors/cameras are correct. – Ensure low res images are checked in applicable capture definition in QubeVu. – Ensure camera is configured correctly.
No Response from QVTracker	<ul style="list-style-type: none"> • Check dimensioner • Unable to trigger the dimensioner, may be in a stopped or starting system status
New capture Id timeout	<ul style="list-style-type: none"> • Initial capture ID has been queried, capture has been sent, the system did not provide a new capture within 5 seconds • Try to perform a dimension again
No capture Id	<p>There is no communication from the iDimSS software to the dimensioner. Issues could be:</p> <ul style="list-style-type: none"> • Network connection from the iDimSS software to the dimensioner is down ▶ Solution: Check connection to dimensioner. Restart hub of device <ul style="list-style-type: none"> • Dimensioner is powered off ▶ Solution: Turn on dimensioner.
System Not Ready	<p>Dimensioner will not dimension freight in any other state such as Stopped, Started, Starting or Configuring.</p> <p>To determine cause of the not ready state, further tech support and troubleshooting is required. Contact Rice Lake Weighing Systems at 800-472-6703 or closest service center.</p>
Forks Too Low	<p>The forklift's tines are too low.</p> <p>Stop and Go:</p> <ul style="list-style-type: none"> • Forklift forks are too low ▶ Solution: Raise forklift forks slightly to allow for stop and go to separate the pallet from the floor.
Forks Too High	<p>The forklift's forks are too high.</p> <p>Stop and Go:</p> <ul style="list-style-type: none"> • Forklift forks are too high ▶ Solution: Lower forklift forks slightly to allow for stop and go to separate the pallet from the floor. <p>Drop and Clear:</p> <ul style="list-style-type: none"> • Forklift is too close to the freight; Dimensioner recognizes the reflectors within the work area and is trying to dimension the freight as Stop and Go. ▶ Solution: Clear forklift and reflectors from 8.5 ft x 8.5 ft (259.1 cm x 259.1 cm) work area.
Unknown Dimensions Center the freight or check the reflectors	<p>The item dimensioned is out of bounds on one side of the work area or dimensioner does not see both reflectors.</p> <p>Stop and Go</p> <ul style="list-style-type: none"> ▶ Solution: <ul style="list-style-type: none"> – If possible, dimension the item as Drop and Clear. – Check reflectors. If damaged, replace. <p>Drop and Clear</p> <ul style="list-style-type: none"> ▶ Solution: <ul style="list-style-type: none"> – Center the freight. – Remove any other items from work area.

Table 6-2. Error Codes Responses and Descriptions

Response	Description
Unknown Dimensions Center the freight	Item dimensioned is out of bounds on one side of the work area. ► Solution: • Center the object under the dimensioner, within work area. • Remove any other items from work area.
Unknown Dimensions Item is too large - drop and clear	The item is too large, drop and clear. Stop and Go • Item is out of bounds on two sides of work area. ► Solution: – If Pallet is more than 2 in above the ground, lower the freight and re-scan. – If possible, dimension item as Drop and Clear.
Unknown Dimensions Item too large	The item Item is too large. Drop and Clear • Item is out of bounds on two sides of work area. ► Solution: – If the item is smaller than max dimension of size of the dimensioner then confirm the work area size and orientation are correct.
Capture Error	When a capture error occurs while processing a request to the dimensioner, a detailed error log is recorded with a summary that includes: • Dimensioner Name • Pro Number/Manifest Number • Error Message • Error Date
Unknown Error	An error has occurred that is not a part of the errors listed above Check error log

Table 6-2. Error Codes Responses and Descriptions (Continued)



NOTE: Duplicate messages can be sent with a unique identifier during processing when connection to the host is lost.

6.4 RTD Desktop Display

Enable the web real-time display for the dimensioner in the dimensioner settings to display the RTD Desktop Display prompt in the home screen. Select the dimensioner in the Real-Time Display menu.

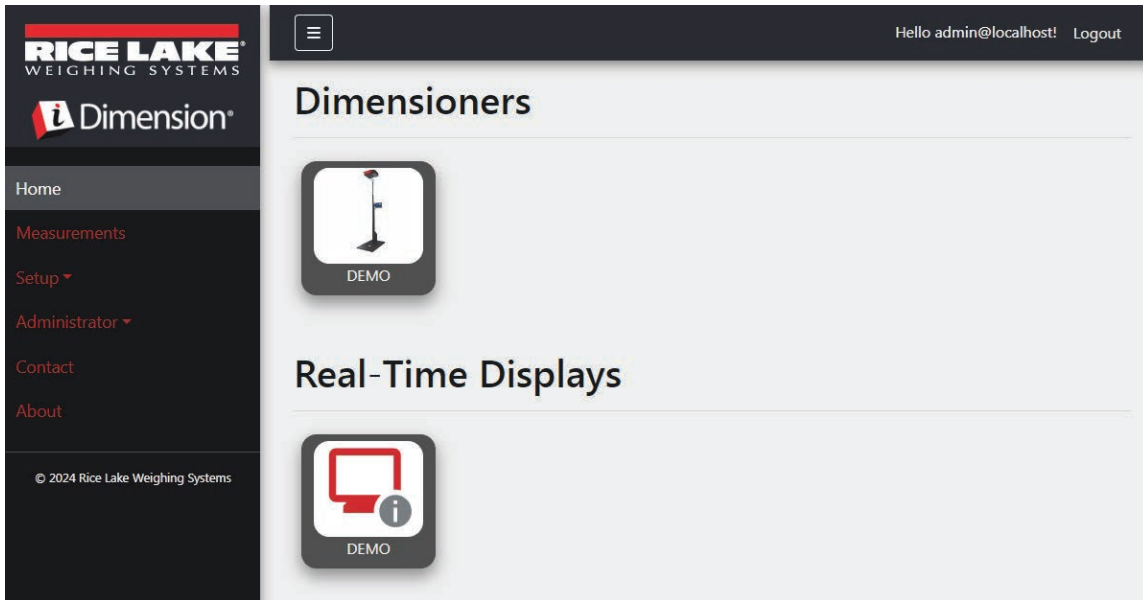

Figure 6-1. Real Time Display on Home Screen

Desktop application opens a new tab to display the dimensioner Real-Time Display

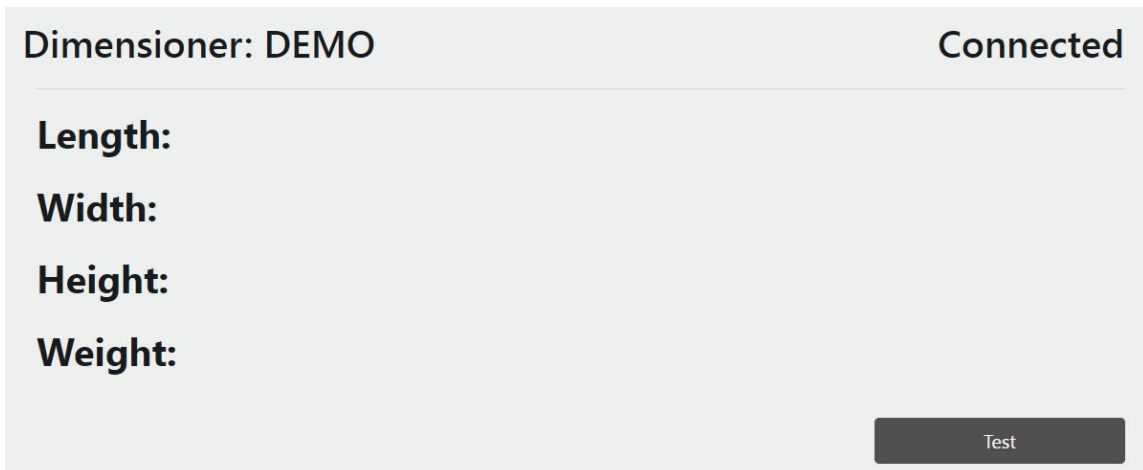
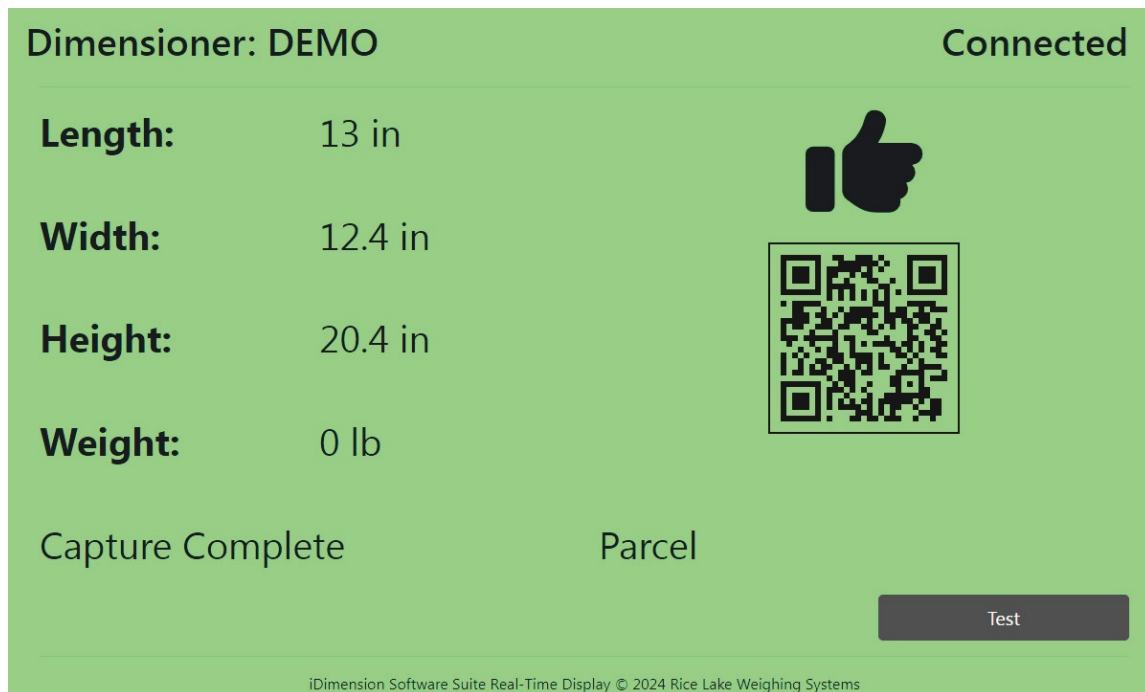

Figure 6-2. Real Time Display on Home Screen

When dimensioner is triggered, the Real-Time Display window displays the results of the measurement Display. If measurement is successful, a green screen with a thumbs up displays (Figure 6-3). If



iDimension Software Suite Real-Time Display © 2024 Rice Lake Weighing Systems

Figure 6-3. Successful Measurement Real Time Display



NOTE: Visibility of the QR code and the on-screen Test button are toggled in the dimensioner settings.

If there is an error, one of the following error messages displays:

Response	Description
Unknown Dimensions: Center freight or check the reflectors	The item dimensioned is out of bounds on one side of the work area or dimensioner does not see both reflectors. If the dimensioner configured for Stop and Go <ul style="list-style-type: none"> Solution: <ul style="list-style-type: none"> – If possible, dimension the item as Drop and Clear. – Check reflectors. If damaged, replace. If the dimensioner configured for Drop and Clear <ul style="list-style-type: none"> Solution: <ul style="list-style-type: none"> – Center the freight. – Remove any other items from work area.
Unknown Dimensions: Center the freight	Item dimensioned is out of bounds on one side of the work area. <ul style="list-style-type: none"> Solution: <ul style="list-style-type: none"> – Center the object under the dimensioner, within work area. – Remove any other items from work area.
Unknown Dimensions: Item is too large - drop and clear	This error only occurs in Stop and Go mode. Issue could be: Item is out of bounds on two sides of work area. <ul style="list-style-type: none"> Solution: <ul style="list-style-type: none"> – If Pallet is more than 2 in (5 cm) above the ground, lower the freight and re-scan. – If possible, dimension item as Drop and Clear.
Unknown Dimensions: Item is too large	This error only occurs in Drop and Clear mode. Issue could be: Item is out of bounds on two sides of work area. <ul style="list-style-type: none"> Solution: If the item is smaller than max dimension of size of the dimensioner then confirm the work area size and orientation are correct.
Forks Too Low	If dimensioner is configured for Stop and Go, issue could be: Forklift forks are too low <ul style="list-style-type: none"> Solution: Raise forklift forks slightly to allow for stop and go to separate the pallet from the floor. If dimensioner is configured for Drop and Clear, issue could be: Forklift is too close to the freight; Dimensioner recognizes the reflectors within the work area and is trying to dimension the freight as Stop and Go. <ul style="list-style-type: none"> Solution: Clear forklift and reflectors from 8.5 ft x 8.5 ft (260 x 260 cm) work area.

Table 6-3. Real-Time Display Error Codes

Response	Description
System Not Ready	Dimensioner is not in a Ready or Remove state. Issue could be: Dimensioner will not dimension freight in any other state such as Stopped, Started, Starting or Configuring . To determine cause of the not ready state, further tech support and troubleshooting is required. Contact Rice Lake Weighing Systems at 800-472-6703 or nearest Rice Lake Weighing Service Center
Capture timeout	No Item Under Dimensioner. Problems could be: Dimensioner does not see an object. iDimSS software times out if dimensioner does not respond. <ul style="list-style-type: none"> • Solution: Place freight under dimensioner and re-scan. iDimSS is not able to get data from one of the configured sensors/cameras. <ul style="list-style-type: none"> • Solution: <ul style="list-style-type: none"> – Confirm the configured sensors/cameras are correct. – Ensure low res images are checked in applicable capture definition in QubeVu. – Ensure camera is configured correctly.
No capture ID	No Connection to Dimensioner There is no communication from the iDimSS software to the dimensioner. Issues could be: Network connection from the iDimSS software to the dimensioner is down <ul style="list-style-type: none"> • Solution: Check connection to dimensioner. Dimensioner is powered off <ul style="list-style-type: none"> • Solution: Turn on dimensioner.
Yellow screen that reads: Reconnecting...	No Connection to iDimSS The RTD is not able to see the iDimSS software. Issues could be: RTD device is not connected to iDimSS device network <ul style="list-style-type: none"> • Solution: Reconnect RTD to device network. • Solution: Verify IP address and port number in RTD settings. If the RTD device is connected to iDimSS device network, iDimSS service may not be running. <ul style="list-style-type: none"> • Solution: Ensure iDimSS software is running.
Gray screen that reads: Capture Error	When a capture error occurs while processing a request to the dimensioner, a detailed error log is recorded with a summary that includes: <ul style="list-style-type: none"> • Dimensioner Name • Pro Number/Manifest Number • Error Message • Error Date

Table 6-3. Real-Time Display Error Codes (Continued)

6.5 iDim SS Images

QVRemoteImage1 through QVRemoteImage8

QubeVu Remote Images are the images provided from the sensors. The primary use of these images is to include the bounding of the items measured. Each sensor will provide a unique view from the sensors angle.

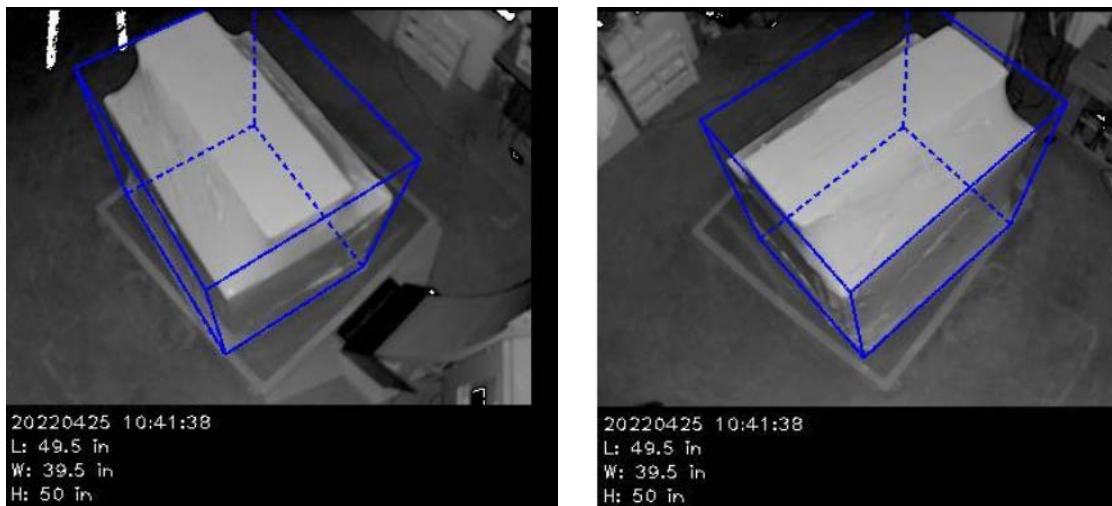

QVRemoteCameraImage1 and QVRemoteCameraImage2

QubeVu Remote Camera Images are the images provided from the color cameras. The primary use of these images is to provide a high-resolution image for use in object identification and claims processing for damaged freight. Each camera will provide a unique view from the installation location. The Axis camera can be configured from the IP address when typed into a web browser.





© Rice Lake Weighing Systems Content subject to change without notice.

230 W. Coleman St. • Rice Lake, WI 54868 • USA USA: 800-472-6703 • International: +1-715-234-9171