

Healthweigh® H151-11-5

*Class I MDR Physician Scale
with Height Measuring Rod*

Operation Manual



© Rice Lake Weighing Systems. All rights reserved.

Rice Lake Weighing Systems® is a registered trademark of
Rice Lake Weighing Systems.

All other brand or product names within this publication are trademarks or
registered trademarks of their respective companies.

All information contained within this publication is, to the best of our knowledge, complete and
accurate at the time of publication. Rice Lake Weighing Systems reserves the right to make
changes to the technology, features, specifications and design of the equipment without notice.

The most current version of this publication, software, firmware and all other product
updates can be found on our website:

www.ricelake.com

Revision History

This section tracks and describes manual revisions for awareness of major updates.

Revision	Date	Description
A	October 3, 2023	Established revision history
B	August 13, 2024	Updated compliance and certification sections
C	November 5, 2024	Added power supply to parts list

Table i. Revision Letter History



Technical training seminars are available through Rice Lake Weighing Systems. Course descriptions and dates can be viewed at www.ricelake.com/training or obtained by calling 715-234-9171 and asking for the training department.

Contents

1.0 Introduction	5
1.1 Disposal	6
2.0 Setup	7
2.1 Unpacking the Scale	7
2.2 Parts for Assembly	7
2.3 Assembling the Scale	8
2.4 Transporting the Scale	9
2.5 Setting the Device	10
3.0 Operation	11
3.1 Keypad	11
3.2 Display	12
3.3 Scale Operation	13
3.4 Weighing	13
3.5 BMI Procedure	13
3.6 Rechargeable Battery	14
3.7 Power and Communication Connections	15
3.8 Height Readings	16
3.9 Communication	16
3.10 Print Button	16
4.0 Maintenance	17
4.1 Cleaning	17
4.2 Replacing Batteries	17
4.3 Calibration Procedure	17
4.4 Troubleshooting	18
5.0 Specifications	20
6.0 Appendix	21



Rice Lake continually offers web-based video training on a growing selection of product-related topics at no cost. Visit www.ricelake.com/webinars

1.0 Introduction

The Healthweigh® Physician Scale is an electrically-powered device designed to be placed on/integrated into the floor and upon which a patient is intended to stand to measure and display total body weight. It is not designed to weigh a wheelchair-bound patient or bed/stretcher.

Lightweight and slender, the scale is a professional tool providing precision weighing information. The design patented scale is multi-functional; weight is automatically displayed; after height input into scale, the patient's BMI is displayed.



Manuals are available from Rice Lake Weighing Systems at www.ricelake.com/manuals

Warranty information is available at www.ricelake.com/warranties

Safety Definitions:



DANGER: Indicates an imminently hazardous situation that, if not avoided, will result in death or serious injury. Includes hazards that are exposed when guards are removed.



WARNING: Indicates a potentially hazardous situation that, if not avoided, could result in serious injury or death. Includes hazards that are exposed when guards are removed.



CAUTION: Indicates a potentially hazardous situation that, if not avoided, could result in minor or moderate injury.



IMPORTANT: Indicates information about procedures that, if not observed, could result in damage to equipment or corruption to and loss of data.

General Safety



Do not operate or work on this equipment unless this manual has been read and all instructions are understood. Failure to follow the instructions or heed the warnings could result in injury or death. Contact any Rice Lake Weighing Systems dealer for replacement manuals.



WARNING: Failure to heed could result in serious injury or death.

Do not use in the presence of flammable materials.

Operating at other voltages and frequencies than specified could damage the equipment. Use only medical approved mains adapters compliant with EN60601-1 standard.

Do not modify this equipment without authorization of the manufacturer.

Do not put this equipment next to or stacked on top of other equipment. This may result in malfunction. If such placement is unavoidable, ensure equipment is monitored regularly for correct operation.

Do not use accessories, transducers or cables other than those specified or provided by manufacturer. This could result in increased electromagnetic emissions or decreased electromagnetic immunity leading resulting in malfunction (see [Section 7.0 on page 22](#)).

Portable RF communications accessories (including peripherals such as antenna cables and external antennas) should be used no closer than 30 mm to the equipment or cables specified by the manufacturer. This may result in equipment performance degradation (see [Section 7.0 on page 22](#)).

Ensure the equipment is located in a shielded location. Failure to do so may result in performance degradation, interference with other equipment or interference with radio services.

This equipment has been tested for radiated RF immunity at selected frequencies. Using this equipment near equipment emitting other frequencies could result in improper operation (see [Section 7.0 on page 22](#)).



CAUTION: To prevent injury, never leave the person being weighed unattended while on the scale.

To prevent injury, do not transport the scale while a patient is on the scale.

Make sure no load is on the scale before transporting the scale.

Do not drop the scale or subject it to violent shocks.

The scales are for determining weight of persons in rooms intended for carrying out medical care. The scales are NOT intended to diagnose, prevent and monitor diseases. The scales are equipped with serial interface that can connect to the equipment compliant with EN60601-1 standard.

Do not use scale for dynamic weighing.

Do not leave a permanent load on the weighing plate. This can damage the scale.

Be careful to avoid shock and overloading the scale in excess of the prescribed maximum load rating (MAX) minus any tare weight that is already present.

Never operate the scale in a hazardous location.

The scale design is not explosion-proof. Flammable mixture can form from anesthetic means containing oxygen or nitrous oxide (laughing gas).



IMPORTANT: For accurate weighing, the scale must be placed on a flat, stable surface.

For accurate weighing, verify proper operation according to the procedure described in this manual before each use.

If the "LO Bat" indicator activates, for accurate weighing, recharge the battery or connect the scale to an AC power source as soon as possible.

To avoid cross contamination, clean the scale plate after each weighing. Avoid direct skin contact during weighing.

The H151-11-5 is not equipped with the function of rechargeable battery.

The purpose of this scale is to determine weight in the course of medical practice.

Used as non-automatic scale, a person is to be positioned in the center of the scale plate. Weight can be read after stable value has been obtained.

Materials in the products have been tested and approved for the safe use by operator and patient.

All batteries included with Healthweigh products intended for sale in the EU market are classified as 'Portable Batteries for General Use' and comply with European Battery Regulation (EU) 2023/1542.

1.1 Disposal



Product Disposal

The product must be brought to appropriate separate waste collection centers at the end of its life cycle.

Proper separate collection to recycle the product helps prevent possible negative effects on the environment and to health, and promotes the recycling of the materials. Users who dispose of the product illegally shall face administrative sanctions as provided by law.

Battery Disposal

Dispose of batteries at appropriate waste collection centers at the end of their life cycle in accordance with local laws and regulations. Batteries and rechargeable batteries may contain harmful substances that should not be disposed of in household waste. Batteries may contain harmful substances including but not limited to: cadmium (Cd), lithium (Li), mercury (Hg) or lead (Pb). Users who dispose of batteries illegally shall face administrative sanctions as provided by law.



WARNING: Risk of fire and explosion. Do not burn, crush, disassemble or short-circuit lithium batteries.

2.0 Setup

2.1 Unpacking the Scale

Visually inspect the scale to ensure all components are included in the box.

The box should contain the scale, this manual and a box labeled *Parts Inside*.

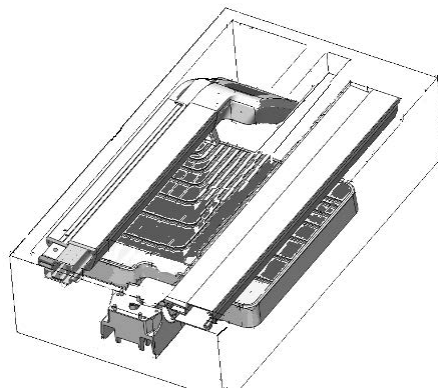

Figure 2-1. Unpacking the Scale

The *Parts Inside* box includes the following parts:

- Two (2) Wheels
- One (1) wheel hinge
- Five (5) pan head cross recess M5 x 35 screws
- Two (2) pan head cross recess M4 x 16 screws
- 6 AA batteries
- Medical-approved power supply with shielding and 1500 mm cable (230/120/ ACV 50/60 Hz, 9 VDC 0.5 AMP)

2.2 Parts for Assembly

Remove the following parts from the box and arrange them on a clear work area:

- Scale platform
- Upper height rod
- Upper pillar with indicator
- Bottom pillar



CAUTION: Take care not to drop parts. Mishandling parts may cause damage to parts or injury to personnel.

Use the following tools to assemble the scale:

Philips screwdriver size 2

2.3 Assembling the Scale

1. Insert the bottom pillar to the scale platform, using the studs as guides.



CAUTION: Take care **NOT** to catch the load cell cable between these parts.



IMPORTANT: Pay attention that there are two screw holes on the bottom pillar, which on assembly needs to be position upward.

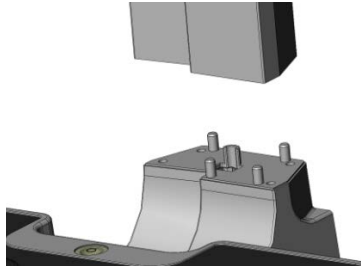

Figure 2-2. Insert Bottom Pillar to Scale Platform

2. Insert the four M5 screws and tighten them in place with Phillips screwdriver.

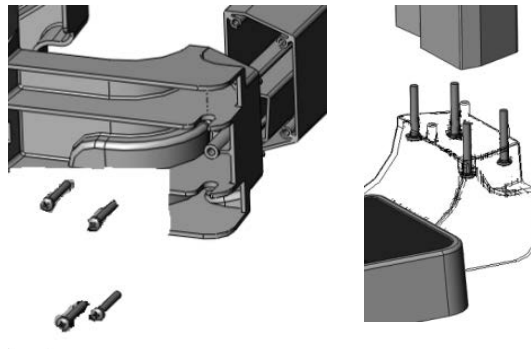

Figure 2-3. M5 Screws Installation

3. From the *Parts Inside* box, take out the two wheels and the hinge.
4. Place each wheel on the hinge and assemble them in the groove, locking in place using the M5 screw and a Phillips screwdriver.

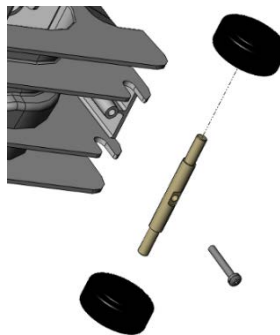



Figure 2-4. Wheel Installation

5. Insert the upper pillar into the bottom pillar.

 **IMPORTANT:** Take care not to damage the load cell cable.

6. Insert the extra cable into the bottom pillar.
7. Insert the height rod edge into the appropriate rail.
8. Secure the upper unit assembly by screwing the two M4 screws in the back of the unit.

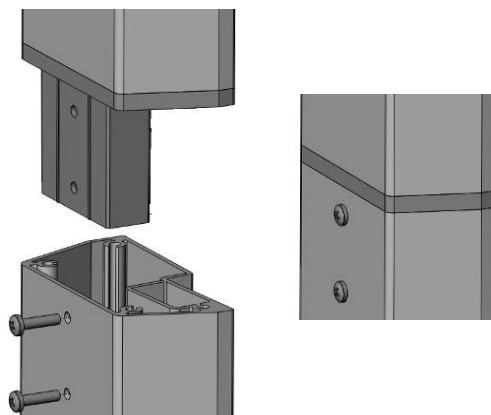



Figure 2-5. Assembling Pillars Before (left) and After (right)

2.4 Transporting the Scale

The scales are equipped with two wheels, which enable it to be transported over short distances.

 **CAUTION:** Ensure that there are no other people in the immediate vicinity.
Ensure there is no load on the scale
Do not drop the scale during repositioning. Dropping the scale, might damage the scale and/or cause personal injury.

1. Unplug the power adapter from the socket.
2. Tilt the scale back so it can freely move on the wheels.
3. Relocate the scale to its new location.
4. Set the device in an upright position.
5. Plug the power adapter unit into the socket.

2.5 Setting the Device

1. Setup the device so it only makes contact with the ground via the foot screw.
2. Setup the scale so that the weighing area does not touch other objects.
3. While you are weighing, ensure that the patient doesn't touch the scale display or pole.
4. Place the scale on a flat, stable surface.

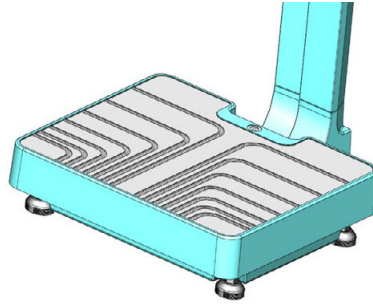

Figure 2-6. Scale Footing

5. Align the scale by turning the foot screws the air bubble in the spirit level must be precisely positioned in the middle of the circle.

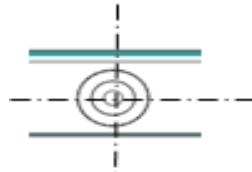

Figure 2-7. Scale Footing

3.0 Operation

3.1 Keypad



Figure 3-1. Keypad







Key	Name	Function
	On/Off	Turns the scale on or off.
	Print - kg	A long press will trigger a transmission of data sent out by RS232 (see Section 3.8 on page 16). When data is sent out from the port, the display flashes the word PRINT to acknowledge the data was sent.
	Zero	Zeroes the weight on the scale if the scale is stable. This function will only work if the weight on the scale is 2% or less of full capacity.
	Hold/Release	Pressing on this key while HOLD indicator is off will keep the most current weight value shown on the display along with the HOLD indicator. Pressing on this key while HOLD indicator is on will release the weight and turn off the HOLD indicator. This key is not active in BMI mode.
	BMI	Enters BMI mode. Only works if there is a locked weight shown on the display and the function is turned on in the configuration settings.
	Up/Down	Adjusts the value of the flashing digit/number.

Table 3-1. Keypad Functions



Key	Name	Function
	Clear	Causes the value to return to default (170.0 cm). In BMI final result display, pressing this key will return the scale to weighing mode.
	Enter	Accepts the value of the parameter last entered and moves to the next stage. A long press during scales start-up process will enter id display (before parameter mode).

Table 3-1. Keypad Functions (Continued)

3.2 Display

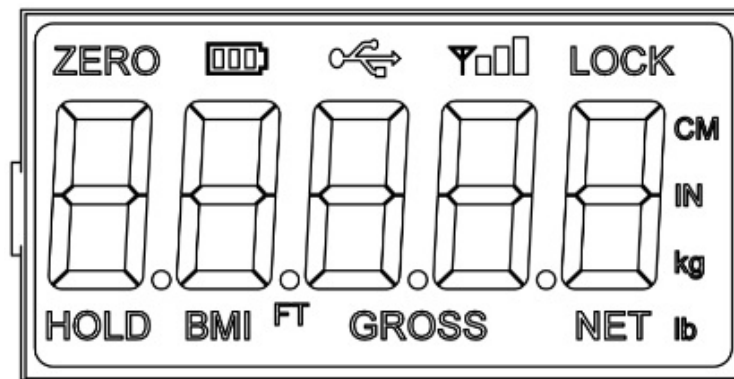

Figure 3-2. Display

Display	Description
ZERO	Scale ready for weighing
Battery Indication	Power left in the battery
USB	USB connected to the scale
LOCK	Weight is stable and the display is locked on the value
CM	Unit of length on the SI measurement system
IN	Unit of length on the Imperial and US customary measurement systems
kg	Unit of mass on the SI measurement system
lb	Unit of mass on the Imperial and US customary measurement system
NET	Indicates net weight value while tare is on
GROSS	Indicates eight value while tare is off
FT	Unit of length on the Imperial and US customary measurement system
BMI	Indicates BMI calculation is on
HOLD	Indicates weight reading will remain on screen until release (by pressing the HOLD again)
oz	Unit of mass on the Imperial and US customary measurement systems

Table 3-2. Display Descriptions

3.3 Scale Operation

1. To operate the scale, using the AC adapter, insert the AC adapter plug into the back of the scale and the AC adapter in to the wall power socket.
2. To operate the scale with dry batteries, insert the batteries (if it is the initial use).
3. Press the **ON/OFF** button to turn the scale on.
4. The display will show *START*, display test, version number and finally *00.0*.
5. When the self-test function is complete, the digital display should read *00.0* and the **CHARGE** indicator should be illuminated on the back.



IMPORTANT: Firmware version: 11454

The scale is ready to weigh load.

3.4 Weighing

1. Place a weight on the scale. The digital display should blink until the weight calculation is complete.
2. Press a short press, on the **PRINT** button to select the weight units, either in kilograms or in pounds.
3. Press the **REWEIGH** button; the digital display should again show the weight of the scale display.
4. To keep the weight reading, press the **HOLD** button; the *HOLD* will appear on the display.
5. Remove the weight from the scale. The digital display should continue to show the weight.
6. Press the **HOLD** button, the **HOLD** indicator will disappear and the digital display should return to zero.



WARNING: Three beeps will sound upon weighing. Make sure the **HOLD is released if no beeps sounded.**



NOTE: If the set up procedure failed, refer to the **TROUBLESHOOTING section for instructions. If the problem is not resolved, refer to qualified service personnel.**

When the AC adapter is inserted into power source the LED lights up red. When dry batteries are fully drained, replace the batteries.

3.5 BMI Procedure

1. Person steps on scale while *ZERO* displays.



IMPORTANT: While you are weighing, ensure that the patient doesn't touch the scale display.

2. Weight is display (without **HOLD** annunciator turned on).
3. Press the **BMI** button to enter BMI mode. **BMI** and **cm** indicators are on and the display shows the height's default value 170.0 cm. All digits are flashing.
4. Use **UP/DOWN** buttons to adjust the entire value. Pressing once will adjust by 0.5 cm. If you hold the key down it will keep increasing or decreasing the values.
5. Press **ENTER** to accept the values. BMI value shows on the display.
6. Pressing **CLEAR** to return to weighing mode. BMI indicator is off.



NOTE: The last height value entered is saved until the Zero is displayed or negative weight is detected. At this point, the value returns to the default value.

Hold/Release Function

1. When the person is on the scale, press the **HOLD\RELEASE** key.
2. When the person steps off the scale the weight will remain the same. The zero flag will not turn on.
3. At this stage the **ZERO** key will not work. The only way to return to zero from here is to press the **HOLD\RELEASE** key once more.

3.6 Rechargeable Battery

For dry cell batteries, the indicator can be supplied with 6 AA dry cell batteries, which will be inserted at the back of the indicator. The batteries will be secured with a cover placed on the indicator back.

1. Remove the battery compartment cover.
2. Insert the supplied batteries.
3. Reinstall the battery compartment cover.

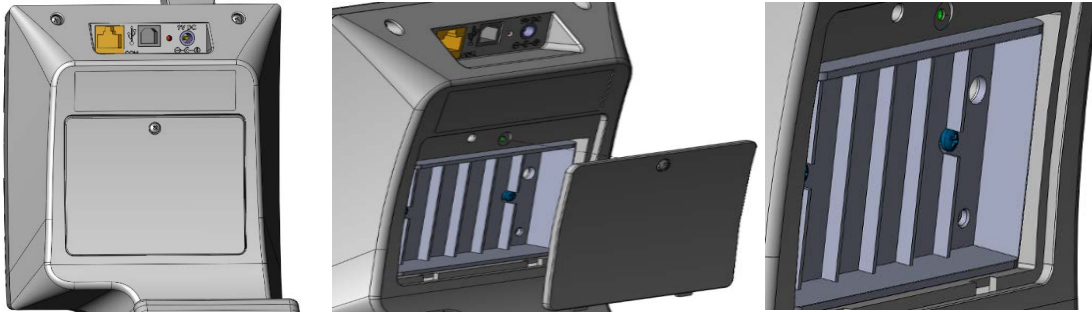

Figure 3-3. Battery Change Procedure



NOTE: A Philips head screwdriver is required for battery removal.



IMPORTANT: Dispose of batteries at appropriate waste collection centers at the end of their life cycle in accordance with local laws and regulations. Batteries and rechargeable batteries may contain harmful substances that should not be disposed of in household waste. Batteries may contain harmful substances including but not limited to: cadmium (Cd), lithium (Li), mercury (Hg) or lead (Pb). Users who dispose of batteries illegally shall face administrative sanctions as provided by law.

Battery Indicator

Battery Status	Flag Indicator
Maximum battery value	3 bars are on
Medium 2 battery value	2 bars are on
Medium 1 battery value	1 bar is on
Low battery	Battery frame
Minimum	Flashing battery frame
Critical	Scrolling <i>LOW BAT</i> and auto shutoff
No battery	Off

Table 3-3. Battery Status Indicators

- If external power supply is connected the battery flag is turned off.
- When on battery, the backlight power is reduced to 60 percent.

3.7 Power and Communication Connections

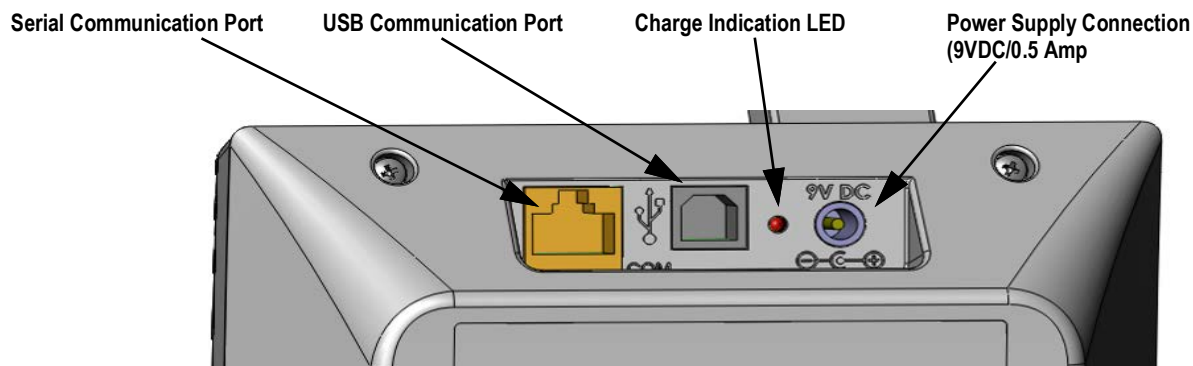

Figure 3-4. Back of Indicator

Port	Location
Serial Communication Port	An RS232 communication cable can be connected to the left connector (labeled COM) and then a computer.
USB Communication Port	A USB communication cable can be connected to the middle connector (labeled with the USB symbol) and then a computer.
Power Supply Connection	Connect the power adapter to the right connector, (labeled with the power inlet specification). Next, connect the power adapter to the wall socket.

Table 3-4. Port Connection Locations



NOTE: CHARGE indicator led will light RED upon connecting the power adapter. On scales with dry batteries the led will continue to emit RED.

3.8 Height Readings

Use the following procedure to perform height readings.

1. Lift up the height level and extract the height rod.
2. Position the patient on the center of the scale.
3. Gently lower the height rod, until it touches the patient's head.
4. Verify the patient is looking forward and the height level is horizontal.
5. Height reading can be seen on the ruler, as seen on the yellow marking.

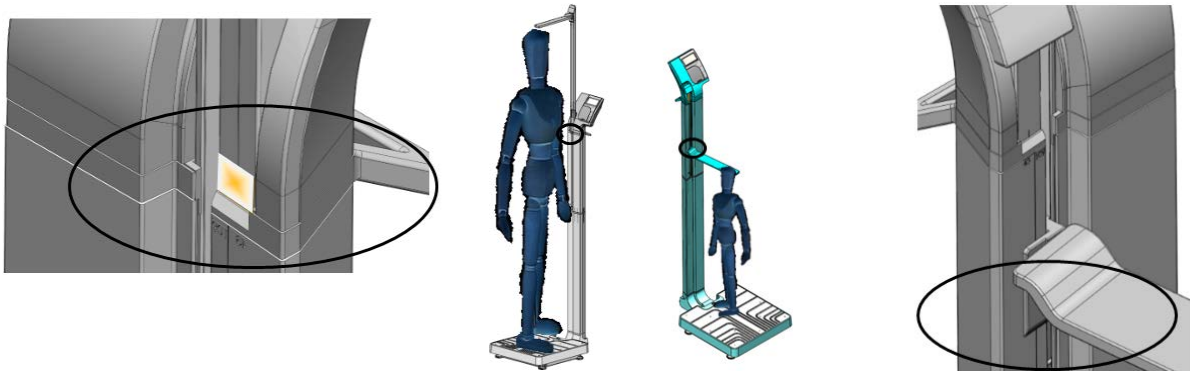

Figure 3-5. Yellow Ruler Locations

3.9 Communication

The scale has a communication protocol: ESC protocol. An ESC protocol is using the escape (0X1B or ASCII 27) to indicate that there is a command following. On the computer, side there must be a listener created by the vendor that will interpret this protocol. This listener must also take care of all the issues regarding data integrity, etc., to make sure that the data sent and received is valid.

Communication can be execute through either RS232 I/O port or USB I/O port. The communication parameters are:

- 9600 baud (selectable in the programming mode)
- 8 data bits
- 1 stop bit
- No parity
- No handshaking

For the USB connection, the USB driver installation will be on Windows® systems. The USB driver can be downloaded from the distributor and installation will be with the distributor's guidance. The scale support ESC protocol, for addition information contact distributor.

3.10 Print Button

A long press will send data from both RS232 and USB ports. When data is transmitted out via a port the display flashes the word PRINT to acknowledge the data was sent.

In weight mode

PATIENT WEIGHT 60.1 kg

In BMI (On calculated BMI display only)

For kg Unit of Measurement:

PATIENT WEIGHT 60.1 kg

PATIENT HEIGHT 170.0 cm

PATIENT BMI 20.8

In case of underweight or overweight, the word UNDER or OVER will be sent accordingly.

4.0 Maintenance

This section provides instructions for maintenance, cleaning and troubleshooting Healthweigh scale models.



IMPORTANT: Before first use and after periods of non-use, check the scale and batteries for proper operation and function. If the scale does not operate correctly, refer to qualified service personnel.

Check overall appearance of the scale for damage, wear and tear.

Check the batteries for damage, wear and tear. Do not use if damaged.

Inspect AC adapter for cord cracking or fraying or for broken or bent prongs.

For models with dry battery powered indicators, remove the batteries before periods of non-use.



WARNING: Maintenance operations not mentioned in this section, should be performed by qualified service personnel.

4.1 Cleaning

Proper care and cleaning is essential to ensure a long life of accurate and effective operation.



WARNING: Disconnect the scale from the AC power source before cleaning.



CAUTION: Do not immerse the scale into cleaning or other liquid solution.

Clean all external surfaces with a clean damp cloth or tissue.

4.2 Replacing Batteries

On a low battery indication, follow the instructions on how to replace the batteries.



WARNING: Before you replace the batteries, disconnect the scale from the AC power source.

1. Turn off the scale.
2. Open the batteries' cover and remove it; keep it for reassembly.
3. Replace the batteries with a new set of 6xAA 1.5V batteries.
4. Close the battery cover.
5. Turn on the scale.



IMPORTANT: Dispose of batteries at appropriate waste collection centers at the end of their life cycle in accordance with local laws and regulations. Batteries and rechargeable batteries may contain harmful substances that should not be disposed of in household waste. Batteries may contain harmful substances including but not limited to: cadmium (Cd), lithium (Li), mercury (Hg) or lead (Pb). Users who dispose of batteries illegally shall face administrative sanctions as provided by law.



WARNING: Inappropriate batteries placement - will cause damage to batteries and might ignite the batteries.

4.3 Calibration Procedure

Calibration to be performed by authorized personnel only.



IMPORTANT: Scales with OIML Class III compliance have a seal to prevent any unauthorized person from performing calibration.

4.4 Troubleshooting

Refer to the following instructions to check and correct any failures before contacting service personnel.

Symptom	Possible Cause	Corrective Action
Scale does not turn on when using rechargeable battery	Dead battery	Connect scale to power source Replace batteries
	Faulty electrical outlet	Use a different outlet
	Bad power supply	Replace adapter
	External object interfering with the scale	Check and remove all interference from the scale
Questionable weight/ Scale does not zero	Weighing tray is not placed properly	Place the tray in its proper place
	Display did not show 0.0 kg before weighing	Remove patient, zero the scale and begin weighing process again
	Scale not placed on a stable surface	Place the scale on a stable surface and begin weighing process again
	Scale is out of calibration	Check weigh with known weight value
	The display shows STOP	Load on the scale exceeds the capacity
the display shows _____	Load is in under-load condition	Make sure the weighing tray is placed on the base
The display shows LO Bat	Rechargeable battery is low	Recharge the battery according to instructions

Table 4-1. Troubleshooting Checklist

Error No.	Definition	Check/Replace
SAT	A/D saturation	Check loadcell - Call technician
RTC	Error in reading Real Time Clock	Battery of real time is empty or faulty board - Call technician

Table 4-2. Error List

5.0 Specifications

H151-11-5 Capacity and Graduation

Max 250 kg, Min 2 kg, Graduation ("e") 0.1 kg

Power Requirements

Adapter 240V/100, 50/60Hz-9 VDC, 500mA

Use only medically approved mains adapters compliant with EN60601-1 standards.

Environmental

Operating Temperatures: 0°C to 40°C

Storage Temperatures: 0°C to 50°C

Humidity: 85%

Use in atmospheric pressure

Product Dimensions

Length: 37.5 cm

Width: 37.5 cm

Standing Platform Height: 8 cm

Display Height: 133 cm

Maximum Height: 220 cm

Weight: 10.5 kg



WARNING: In order to comply with EN60601-1, use UL/CE approved AC/DC adapter UE15WPC-1201255PA.

The scale is not intended for use in the presence of flammable mixtures.

6.0 Appendix

Guidance and Manufacture's Declaration – Electromagnetic Immunity

The medical scale is suitable for use in the specified electromagnetic environment and it has meets the following immunity test levels. Higher immunity levels may cause the medical scale's essential performance lost or degraded.

Phenomenon	Basic EMC Standard or Test Method	Home healthcare facility environment
Electrostatic discharge	IEC 61000-4-2:2008	+/- 8 kV contact +/- 2 kV, +/- 4 kV, +/- 8 kV, +/- 15 kV air
Radiated RF EM fields	IEC 61000-4-3:2006+A1+A2	10 V/m 80MHz-2.7GHz 80%AM at 1kHz
Proximity fields from RF wireless communications equipment	IEC 61000-4-3:2006+A1+A2	See the RF wireless communication equipment table in "Recommended minimum separation distances".
Rated power frequency magnetic fields	IEC 61000-4-8:2009	30A/m; 50 Hz or 60Hz
Electric fast transients bursts	IEC 61000-4-4:2012	Input a.c. power PORT, Input d.c. power PORT, ± 2 kV, 100kHz repetition frequency PATIENT coupling PORT, Signal input/output parts PORT: ± 1 kV, 100 kHz repetition frequency
Surges	IEC 61000-4-5:2014	Input a.c. power PORT, Input d.c. power PORT, Line to line: ± 0.5 kV, ± 1 kV Line to earth: ± 0.5 kV, ± 1 kV, ± 2 kV Signal input/output parts PORT? ± 2 kV
Conducted disturbances induced by RF fields	IEC 61000-4-6:2013	Input a.c. power PORT, Input d.c. power PORT, PATIENT coupling PORT, Signal input/output parts PORT 3 V in 0.15 MHz - 80 MHz 6 V in ISM and/or amateur radio bands between 0.15 MHz and 80 MHz 80 % AM at 1kHz
Voltage dips	IEC 61000-4-11:2004	0% U_T : 0.5 cycle at 0°, 45°, 90°, 135°, 180°, 225°, 270°, and 315° 0% U_T : 1 cycle and 70% U_T : 25/30 cycles sine phase at 0°
Voltage interruptions	IEC 61000-4-11:2004	0% U_T : 250/300 cycle
Proximity magnetic fields immunity test	IEC 61000-4-39:2017	No. Test frequency Modulation Immunity test level (A/m) 30 kHz CW 8 134.2 kHz Pulse modulation, 2.1 kHz 65 13.56 MHz Pulse modulation, 50 kHz 7.5

U_T : rated voltage(s); E.g. 25/30 cycles means 25 cycles at 50Hz or 30 cycles at 60Hz

Guidance and Manufacture's Declaration – Electromagnetic Emissions

The medical scale is suitable for use in the specified electromagnetic environment and it has meets the following standard's emission requirements.

Phenomenon	Profession Healthcare Facility Environment	Home Healthcare Environment
Conducted and radiated RF emissions	CISPR 11, Group 1, Class B	CISPR 11, Group 1, Class B
Harmonic distortion	IEC 61000-3-2:2005+A1+A2, Class A	IEC 61000-3-2:2005+A1+A2, Class A
Voltage fluctuations and flicker	IEC 61000-3-3:2013	IEC 61000-3-3:2013

Recommended Minimum Separation Distances

Nowadays, many RF wireless equipments have being used in various healthcare locations where medical equipment and/or systems are used. When they are used in close proximity to medical equipment and/or systems, the medical equipment and/or systems' basic safety and essential performance may be affected. This medical scale has been tested with the immunity test level in the below table and meet the related requirements of IEC 60601-1-2:2014. The customer and/or user should help keep a minimum distance between RF wireless communications equipment and this medical scale as recommended below.

Test Frequency (MHz)	Band (MHz)	Service	Modulation	Maximum Power (W)	Distance (m)	Immunity Test Level (V/m)
385	380-390	TETRA 400	Pulse modulation 18Hz	1.8	0.3	27
450	430-470	GMRS 460 FRS 460	FM ± 5 kHz deviation 1 kHz sine	2	0.3	28
710	704-787	LTE Band 13, 17	Pulse modulation 217Hz	0.2	0.3	9
745						
780						
810	800-960	GSM 800/900, TETRA 800, iDEN 820, CDMA 850, LTE Band 5	Pulse modulation 18Hz	2	0.3	28
870						
930						
1720	1700-1990	GSM 1800; CDMA 1900; GSM 1900; DECT; LTE Band 1, 3, 4, 25; UMTS	Pulse modulation 217Hz	2	0.3	28
1845						
1970						
2450	2400-2570	Bluetooth, WLAN, 802.11 b/g/n, RFID 2450, LTE Band 7	Pulse modulation 217Hz	2	0.3	28
5240	5100-5800	WLAN 802.11 a/n	Pulse modulation 217Hz	0.2	0.3	9
5500						
5785						



© Rice Lake Weighing Systems Content subject to change without notice.

230 W. Coleman St. • Rice Lake, WI 54868 • USA USA: 800-472-6703 • International: +1-715-234-9171