

150-10-6

*Digital Physician Scale Waist-Level
Software Version 11525*

Operation Manual



© Rice Lake Weighing Systems. All rights reserved.

Rice Lake Weighing Systems® is a registered trademark of
Rice Lake Weighing Systems.

All other brand or product names within this publication are trademarks or
registered trademarks of their respective companies.

All information contained within this publication is, to the best of our knowledge, complete and
accurate at the time of publication. Rice Lake Weighing Systems reserves the right to make
changes to the technology, features, specifications and design of the equipment without notice.

The most current version of this publication, software, firmware and all other product
updates can be found on our website:

www.ricelake.com

Revision History

This section tracks and describes the current and previous manual revisions for awareness of major updates and when the updates took place.

Revision	Date	Description
B	August 18, 2022	Established a revision history; formatted content to match other medical manuals; software version 11525
C	December 11, 2024	Revised batter replacement instructions

Table i. Revision Letter History



Technical training seminars are available through Rice Lake Weighing Systems. Course descriptions and dates can be viewed at www.ricelake.com/training or obtained by calling 715-234-9171 and asking for the training department.

Contents

1.0 Introduction	5
1.1 FCC Compliance	5
1.2 Disposal	5
1.3 Safety	6
2.0 Assembly	7
2.1 Unpacking	7
2.1.1 Repackaging	7
2.2 Scale Assembly	7
2.2.1 Wheel Assembly	8
2.2.2 Attach Second Column to First Column	9
2.2.3 Insert Batteries	10
2.2.4 Power Connection	10
3.0 Operation	11
3.1 Weighing	12
3.2 Hold/Release Function	12
3.3 Using the Body Mass Index (BMI) Function	12
3.4 Troubleshooting	13
4.0 Communication	14
4.1 Push-button Keypad Print	14
4.2 USB Connection	15
5.0 Maintenance	16
5.1 Basic Maintenance	16
5.2 Cleaning	16
6.0 Specifications	17



Rice Lake continually offers web-based video training on a growing selection of product-related topics at no cost. Visit www.ricelake.com/webinars

1.0 Introduction

The 150-10-6 Digital Physician Scale is efficiently designed to provide accurate, reliable and repeatable weight measurements. It is equipped with a handle and two heavy-duty rear wheels for easy portability.



Manuals are available from Rice Lake Weighing Systems at www.ricelake.com/manuals

Warranty information is available at www.ricelake.com/warranties

1.1 FCC Compliance

United States

This equipment has been tested and found to comply with the limits for a Class A digital device, pursuant to Part 15 of the FCC Rules. These limits are designed to provide reasonable protection against harmful interference when the equipment is operated in a commercial environment. This equipment generates, uses, and can radiate radio frequency energy and, if not installed and used in accordance with the instruction manual, may cause harmful interference to radio communications. Operation of this equipment in a residential area is likely to cause harmful interference in which case the user will be required to correct the interference at his own expense.

Canada

This digital apparatus does not exceed the Class A limits for radio noise emissions from digital apparatus set out in the Radio Interference Regulations of the Canadian Department of Communications.

Le présent appareil numérique n'émet pas de bruits radioélectriques dépassant les limites applicables aux appareils numériques de la Class A prescrites dans le Règlement sur le brouillage radioélectrique édicté par le ministère des Communications du Canada.

1.2 Disposal



Product Disposal

The product must be brought to appropriate separate waste collection centers at the end of its life cycle.

Proper separate collection to recycle the product helps prevent possible negative effects on the environment and to health, and promotes the recycling of the materials. Users who dispose of the product illegally shall face administrative sanctions as provided by law.

Battery Disposal

Dispose of batteries at appropriate waste collection centers at the end of their life cycle in accordance with local laws and regulations. Batteries and rechargeable batteries may contain harmful substances that should not be disposed of in household waste. Batteries may contain harmful substances including but not limited to: cadmium (Cd), lithium (Li), mercury (Hg) or lead (Pb). Users who dispose of batteries illegally shall face administrative sanctions as provided by law.



WARNING: Risk of fire and explosion. Do not burn, crush, disassemble or short-circuit lithium batteries.

1.3 Safety

Safety Definitions:



DANGER: Indicates an imminently hazardous situation that, if not avoided, will result in death or serious injury. Includes hazards that are exposed when guards are removed.



WARNING: Indicates a potentially hazardous situation that, if not avoided, could result in serious injury or death. Includes hazards that are exposed when guards are removed.



CAUTION: Indicates a potentially hazardous situation that, if not avoided, could result in minor or moderate injury.



IMPORTANT: Indicates information about procedures that, if not observed, could result in damage to equipment or corruption to and loss of data.

General Safety



Do not operate or work on this equipment unless this manual has been read and all instructions are understood. Failure to follow the instructions or heed the warnings could result in injury or death. Contact any Rice Lake Weighing Systems dealer for replacement manuals.



WARNING

Failure to heed could result in serious injury or death.

Ensure every individual who operates or works with this unit has read and understands all safety information.

Do not transport the scale while someone is on the scale.

Do not allow minors (children) or inexperienced persons to operate this scale.

Do not use in the presence of flammable materials.

Do not use this product if any of the components are loose or cracked.

Do not use near water.

Do not use the scale on slippery surfaces, such as a wet floor.

Do not use this scale when a person's body or feet are wet, such as after taking a bath.

Do not place fingers into slots or possible pinch points.

To avoid cross contamination, the scale should be cleaned regularly.

Prior to cleaning, make sure the scale is disconnected from the power source.

People with disabilities, or who are physically frail, should always be assisted by another person when using this scale.



IMPORTANT

Do not drop the scale or subject it to violent shocks.

Do not jump on the scale.

For accurate weighing, the scale must be placed on a flat, stable surface.

Operating at voltages and frequencies other than specified could damage the equipment.

Avoid contact with excessive moisture.

Do not make alterations or modifications to the scale.

Rice Lake Weighing Systems offers optional AC adapters; utilizing an adapter not supplied by Rice Lake Weighing Systems voids all warranties and approvals.

Weight exceeding the maximum capacity may damage the scale.

2.0 Assembly

2.1 Unpacking

Place the carton on a hard, level surface for unpacking, preferably in the area where it will be used. If parts were damaged in shipment, notify Rice Lake Weighing Systems and the shipper immediately.

Parts contained in the shipping box include:

- Scale (the base and attached column)
- This manual
- White box labeled **Parts Inside** which contains the following:
 - Wheels (2)
 - Wheel hinge (1)
 - Pan head screws (8)
 - AA batteries (6)

2.1.1 Repackaging

All component parts have been wrapped in plastic. Retain the packaging for use in the event that the scale must be returned or moved. It must be properly packed with sufficient packing materials. Whenever possible, use the original carton when shipping the scale back.



IMPORTANT: Damage caused by improper packaging is not covered by the warranty.

2.2 Scale Assembly

Use the following steps to set up the scale.



NOTE: A Phillips head screwdriver will be needed for installation.

1. Place the scale on a hard, level surface for the most accurate weighments in an area where the weighing process will occur.
2. Carefully lift the scale out of the packaging material; lifting by the scale base.



IMPORTANT: The scale base and scale column are connected by a cable and requires great care when removing from the box so that the cabling does not get damaged.



Figure 2-1. Cabling Connecting the Scale Platform and Scale Column

3. Gently thread the excess cable through the top of the scale column to eliminate any excess cable at the bottom of the column. This will eliminate the chance of pinching the cable as the column is being connected to the scale base.

4. Attach the scale column to the base as shown in [Figure 2-2](#) making sure not to pinch the cable.



Figure 2-2. Attach Scale Column to Scale Base

5. Using the enclosed screws, attach the column to the scale base as shown in [Figure 2-3](#).



Figure 2-3. Attach With Screws

2.2.1 Wheel Assembly

Attach the wheel assembly to the scale prior to connecting the second column. To attach the wheels, use the following steps.

1. Attach the two wheels to the wheel assembly rod as shown in [Figure 2-4](#).



Figure 2-4. Attach Wheel Assembly

2. Attach the wheel assembly to the scale using a Phillips head screw and tighten with a screwdriver.

2.2.2 Attach Second Column to First Column

Once the wheel assembly is attached, finish the scale assembly using the following instructions.



NOTE: Ensure that the cable is extending through the top of the lower column so that it can be plugged into the second (upper) column.

1. Plug the cable from the lower column into the upper column.

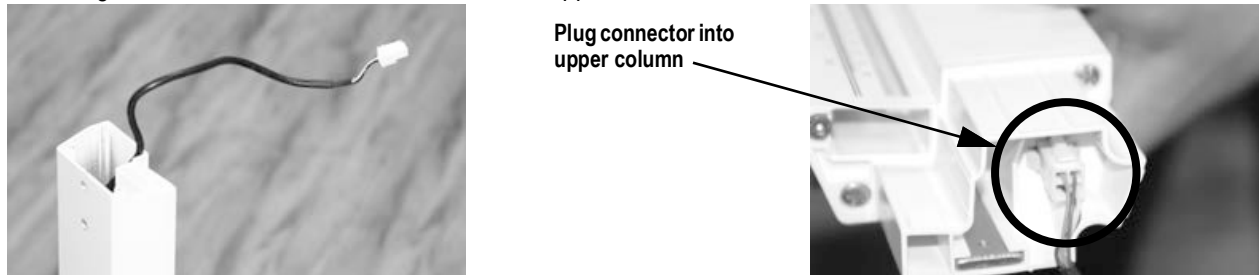

Figure 2-5. Extend Cable Through Scale Column

2. Once the cable is connected, place the upper column onto the lower column, aligning the screw holes. Ensure the cable does not get pinched.

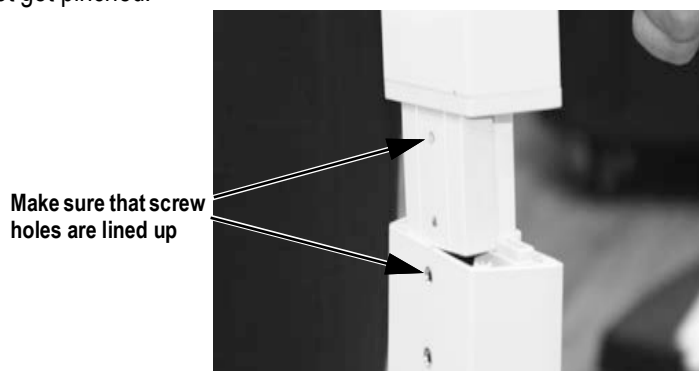

Figure 2-6. Insert Upper Column into Lower Column

3. Secure with two screws using a Phillips head screwdriver.

2.2.3 Insert Batteries

The six AA batteries supplied with the scale provide an average of 25 hours of continuous use.

To install the batteries:

1. Turn thumbscrew counterclockwise then remove battery cover.
2. Insert batteries into the battery chamber as illustrated.

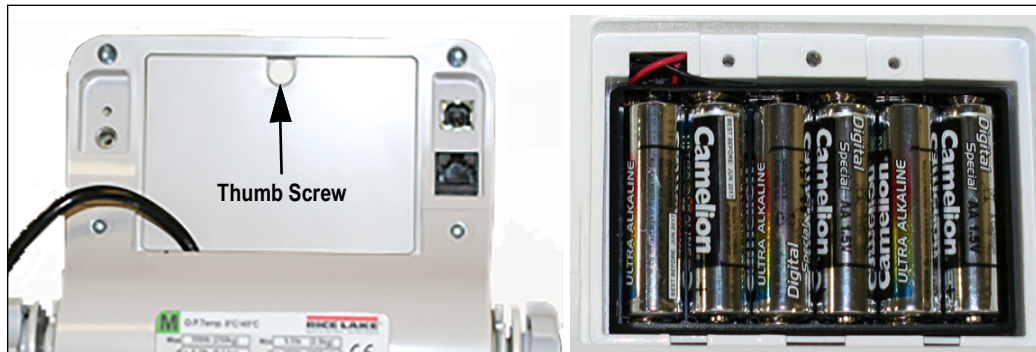

Figure 2-7. Battery Chamber

3. Put the cover in place and turn the thumbscrew clockwise to secure.



NOTE: Remove the batteries prior to storing if the product is not going to be used for an extended period of time.



NOTE: If the LO BAT indicator activates, for accurate weighing, replace the batteries or connect the scale to an AC power source as soon as possible.

2.2.4 Power Connection

An optional AC power adapter can be used when a power outlet is available.



IMPORTANT: Only use power adapters supplied by or purchased from Rice Lake Weighing Systems. The use of a power adapter not from Rice Lake Weighing Systems voids the warranty.

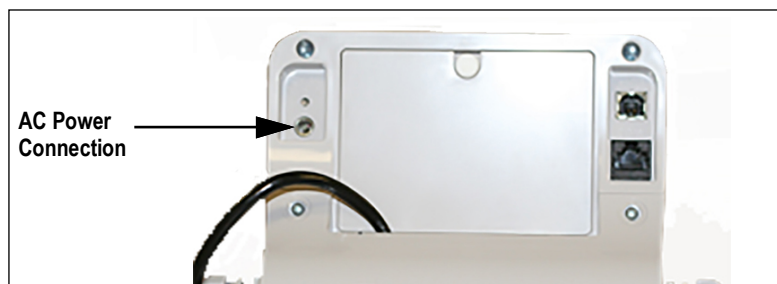

Figure 2-8. Power Connection Site



NOTE: The battery annunciator on the display turns off when using an AC power connection. The brightness of the backlight is reduced to 60% when using battery power.

3.0 Operation

This section describes the front panel and includes procedures for operation of the scale.



Figure 3-1. Front Panel Keypad

Key Descriptions

The unit has nine front panel keys. Key functions are described in the table below.



IMPORTANT: The front panel keys are very sensitive, so only a gentle press is required.











Key	Name	Function
 On/Off	On/Off	Powers the scale on or off.
 Print LB/KG	Print LB/KG	Sends data out from the RS-232 port. Allows to toggle between kilograms and pounds providing that it is enabled in Configuration mode. Cannot toggle while in the BMI mode.
 Zero	Zero	Only functions if the current weight is stable and less than 2% of the capacity of the scale. Anything over 2% requires a recalibration.
 Hold Release	Hold Release	Displays most current weight value on the display and holds that value when the patient is off the scale. A second press releases the weight value. Not active while in BMI mode.
 BMI	BMI	Pressing the BMI key enables access to the BMI (Body Mass Index) mode (defaults when scale is turned on). The patient is gets on the scale, weight stabilizes and press the BMI key. The display then asks for the patient height to calculate out the patient BMI.
 CLEAR	CLEAR	When using the BMI function, the display will be looking for a height entry. Pressing Clear changes this entry back to 190.0 cm (default) or 5 ft, 7.5 in. Once BMI is displayed, pressing the Clear key exits BMI.
 ENTER	ENTER	Used to accept height in BMI mode; accepts the value of the parameter last entered and moves to the next stage. Pressing and holding Enter during startup will display ID. This is the first setup on entering into configuration mode.
 Up/Down Arrows	Up/Down Arrows	Adjusts the value of the flashing digit/number. Adjusts height input (0.5 in/0.5 cm) while in BMI mode.

Table 3-1. Scale Key Functions



3.1 Weighing

Use the following steps to weigh a patient.

1. Press  to turn on the scale. **0.0** displays along with **ZERO** on the upper display.
2. Have the patient step on the scale. The patient's weight is displayed, the **LOCK** annunciator is on and the indicator beeps to indicate the end of the weighing process.
3. Press  to change the display from lb to kg and vice-versa.
4. Press and hold  until **OFF** displays to turn off the scale.

3.2 Hold/Release Function

Use the following steps to use the Hold/Release function:

1. Press  to turn on the scale. **0.0** displays along with **ZERO** on the upper display.
2. Have the patient step on the scale.
3. Press  once the patient's weight stabilizes. The patient's weight and the **HOLD** and **LOCK** annunciators remain on the display when the patient is off the scale.
4. Press  again to return the scale to zero.







NOTE: Pressing  prior to the patient getting on the scale will also hold the weight display.





3.3 Using the Body Mass Index (BMI) Function

Use the following steps in determining the BMI.

LB Mode

1. Ensure the scale is at zero.
2. Have the patient step onto the scale.
3. Have the person step on the scale to obtain a weight. The **LOCK** annunciator appears on the display.
4. Press . The **BMI** and **FT/IN** annunciators light and a default height value of 5 feet and 7.5 inches (5-07.5) flashes.
5. Use   to adjust the height value, and press .
6. The BMI value and **BMI** annunciator are shown on the display. Press  to return to weighing mode and the BMI function will be turned off.

KG Mode

1. Ensure that the scale is at zero.
2. Have the patient step on the scale to obtain a weight. The **LOCK** annunciator appears on the display.
3. Press . The **BMI** and **CM** annunciators appear and a default height value of 170.0 cm (170.0) flashes.
4. Use   to adjust the height value.
5. Press .
6. The BMI value and **BMI** annunciator appear on the display. Press  to return to weighing mode and the BMI function.

3.4 Troubleshooting

Refer to the following table to check and correct any failure before contacting service personnel.

Symptom	Possible Cause	Corrective Action
Scale does not turn on	Dead batteries	Replace batteries or connect to AC power
	Faulty electrical outlet	Use a different electrical outlet
	Bad power supply	Replace adapter
Questionable weight or the scale does not zero	External object is interfering with the scale	Remove the interfering object from the scale
	Display did not show 0.0 before weighing	Help the patient off the scale, zero the scale and begin the weighing process again
	Scale is not placed on a level floor	Ensure scale is level and begin the weighing process again
	Scale is out of calibration	Check the weight with a certified calibration weight
The display shows a STOP message	The load on the scale exceeds the capacity of the scale	Remove the excess weight and use the scale according to manufacture specifications
The display shows LO Bat message	The battery is low	Replace batteries
The display shows E and Err messages as detailed below		
E06	Identifier - ADC	AD too high
E07		AD too low
E10	Overload	Scale has been overloaded. Remove load from scale
E4L	BAT	Battery low, but still usable- one bar left on indicator display
E4U		Battery low and unstable - no bars left on indicator display
E11	CAL	Calibration Error - recalibrate scale
Err 1	Load cell cable may be plugged into wrong connection port	Ensure cable is connected to the load cell connection port. Note: Load cell connection point is located underneath the curved plastic cover of the indicator. Remove four back retaining screws, remove curved back cover to access load cell connection point.
Err 2	Low saturation state (low A/D)	The load cell is not connected properly; Check the cables and mechanical connections; if the problem persists, replace the set of load cells
Err 3	High saturation state (high A/D)	See Err 2
Err 6	Unstable weight; Cannot calibrate	Check the load cell mechanical surroundings and ensure nothing is contacting the load cell and that the cables are properly welded
Err 7	Scale isn't moving	Make sure feet are installed on the scale. Turn the feet all the way in and then back them out three full turns, then level the scale
SAT	Damaged load cell cable	Replace load cell cable
	Load cell cable may be plugged into wrong connection port	Ensure cable is connected to the load cell connection port. Note: Load cell connection point is located underneath the curved plastic cover of the indicator. Remove four back retaining screws, remove curved back cover to access load cell connection point.

Table 3-2. Troubleshooting

4.0 Communication

The unit comes with an RS-232 port that enables weight data to be transmitted to other equipment, such as a computer or printer. The RS-232 cable with DB-9 connector (PN 100719) is available from Rice Lake Weighing Systems. That connection is shown in USB Connection section on the next page.

The RS-232 parameters are:

- 9600 baud (selectable in the programming mode)
- 8 data bits
- 1 stop bit
- no parity
- no handshaking

There are three methods of communication:

- Push-button keypad print
- Standard remote protocol
- Escape protocol

4.1 Push-button Keypad Print

With a stable, in-range weight, press and hold  for at least three seconds, or until the scale emits two quick beeps.



NOTE: If the scale does not beep after five seconds, release  as the weight was either in motion or out of range.

If displaying weight and not BMI, the scale will send out the following 21 character string:

```
xxxxxxxx<SP>uu<SP>mmmmm<SP><CR><LF>
```

Token	Description
xxxxxxxx	Weight with decimal point and “-” sign
<SP>	Space
uu	Unit - lb or kg
mmmmm	Mode - gross or net
<CR>	Carriage return
<LF>	Line feed (moves cursor down to the next line)

Table 4-1. Print Format Tokens

Example:

```
-10 Lb net = <SP><SP><SP><SP>-10.0<SP>lb<SP><SP>Net<SP><SP><SP><CR><LF>
```

```
10 Lb gross = <SP><SP><SP><SP><SP>10.0<SP>lb<SP>Gross<SP><CR><LF>
```

- The scale will send out the following data while in **BMI** mode (displaying the BMI value):

Setting	Value
Gross Weight	215 Lb
Tare Weight	0.0 Lb
Net Weight	215 Lb
Patient Height	6-01.0 ft
Patient BMI	28.4

Table 4-2. BMI Data

4.2 USB Connection

The scale has the capability of connecting to a Windows® computer (PC) using a USB cable (not included) and a terminal emulation program. A terminal emulation program allows the transfer of data between the scale and PC using a serial port.



Figure 4-1. Connection Ports

NOTE: Apple® and Macintosh® computers are unable to transfer the necessary data to the scale. Only use a PC for data transfer.

Connecting software and downloads should always be addressed by the IT department for safety reasons and can vary depending on what type of computer platform is being used.

NOTE: Consult the IT department if driver protections are preventing the use of the USB driver. Driver protections may need to be temporarily disabled on Windows 10 or later computers to allow for the installation of the USB driver.

1. Connect the scale's indicator to a PC using a USB-Type B to USB-Type A cable (not included).
2. Turn the indicator on.

NOTE: In most cases, the PC should find the driver and automatically configure the driver when the scale is plugged into a USB port.

3. Open a terminal emulation program, such as Advanced Serial Port Terminal, pUttY or Hercules (used in this example).
4. Connect to the serial port assigned by the PC (COM5 in example). This can be found in Device Manager. Once selected, press **Open**.

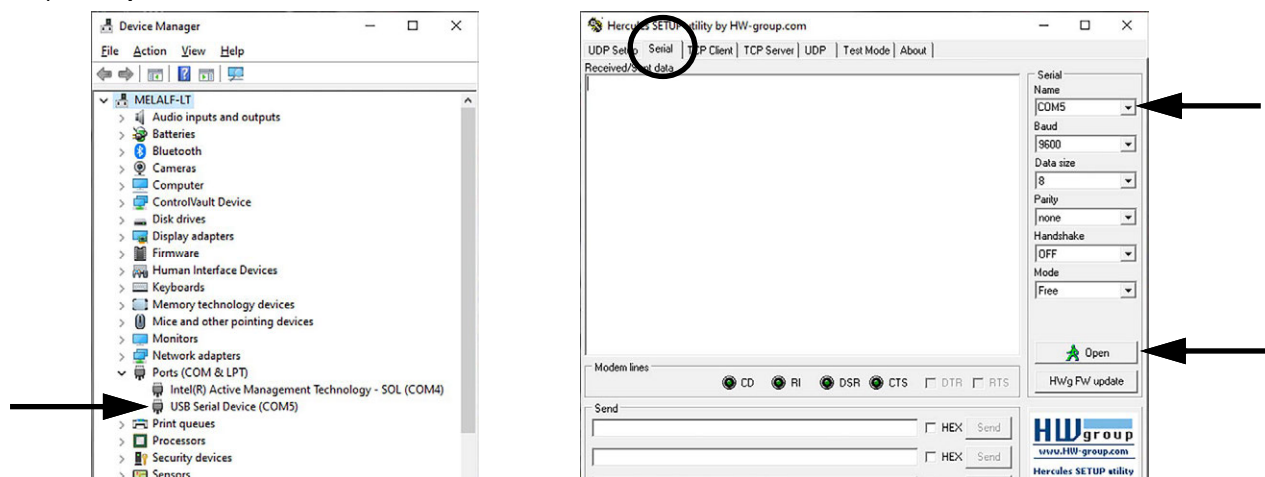

Figure 4-2. Connecting to a Serial Port

5. With weight on the scale, press and hold the **Print** button on the indicator for three seconds. The patient's weight is sent to the PC.

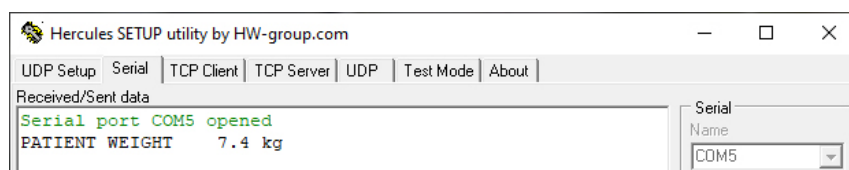

Figure 4-3. Patient Weight Displayed

5.0 Maintenance

The following section provides instructions for maintaining and cleaning the unit.



IMPORTANT: Do not immerse the scale in cleaning or other liquid solutions.

Do not use Isopropyl alcohol or other solutions to clean the indicator display surface.

5.1 Basic Maintenance

Before the first use of the scale and after periods of non-use, check the scale for proper operation and function. If the scale does not operate correctly, contact a qualified service personnel.

Go through the following steps for basic maintenance.

- Check the overall appearance of the entire scale for any obvious signs of damage
- Inspect the condition of the AC power adapter cord for cracking, fraying or for broken or bent prongs

5.2 Cleaning

Proper care and cleaning is essential to ensure a long life of accurate and effective operation. Before beginning the cleaning process, disconnect the scale from the AC power source.

- Clean all external surfaces with a clean, damp cloth or tissue. Mild soap and water solution may be used. Dry with a clean soft cloth
- Do not immerse the scale into cleaning or other liquid solutions
- Do not use Isopropyl alcohol or other solutions to clean the display surface

6.0 Specifications

Power

120 VAC - 9VDC - 60Hz / 230 VAC - 9VDC - 50Hz

Battery Type

6 AA size Alkaline batteries

Battery Use

25 hours continuous use

Automatic power-off can be configured

Data Communications

RS-232 with RJ-45 jack

Selectable baud rate, default - 9600

8 bits

No parity

1 stop bit

No handshaking

Environmental

Operating Temperature 50°F to 104°F (14°C to 40°C)

Storage Temperature 32°F to 158°F (0°C to 70°C)

Humidity 85% relative humidity

Capacity

550 lb x 0.2 lb (250 kg x 100 g)

Dimensions

Scale Platform 14.7 in W x 14.7 in L x 3 in H (37.5 cm W x 37.5 cm L x 7.6 cm H)

Overall Height 48.4 in (123 cm)

Certifications and Approvals



E113986

Complies with ANSI/AAMI ES60601-1:2005/A2:2010/(R)2012

CAN/CSA-C22.2 No. 60601-1:14



© Rice Lake Weighing Systems Content subject to change without notice.

230 W. Coleman St. • Rice Lake, WI 54868 • USA USA: 800-472-6703 • International: +1-715-234-9171