

CARDINAL

CARDINAL®

Cardinal Price Index By Rice Lake Weighing Systems PN

CARDINAL®

RL PN	SUGGESTED LIST	PAGE #	RL PN	SUGGESTED LIST	PAGE #	RL PN	SUGGESTED LIST	PAGE #
10029	CONSULT	225	109640	CONSULT	224	CM738	CONSULT	225
15232	CONSULT	XX	109641	CONSULT	224	CM739L	CONSULT	226
15263	CONSULT	223	109642	CONSULT	224	CM740	CONSULT	225
15266	CONSULT	Not Shown	109643	CONSULT	224	CM741	CONSULT	225
15274	CONSULT	223	109644	CONSULT	224	CM742P	CONSULT	218
15285	CONSULT	223	111251	CONSULT	228	CM743P	CONSULT	218
15295	CONSULT	Not Shown	154029	CONSULT	222	CM744P	CONSULT	218
15297	CONSULT	Not Shown	154030	CONSULT	222	CM745P	CONSULT	218
15306	CONSULT	Not Shown	156479	CONSULT	226,228	CM746P	CONSULT	219
22005	CONSULT	XX	CM701	CONSULT	223	CM747	CONSULT	223
22100	CONSULT	Not Shown	CM702	CONSULT	223	CM748P	CONSULT	224
44793	CONSULT	220	CM703P	CONSULT	224	CM749	CONSULT	225
46285	CONSULT	219	CM704P	CONSULT	224	CM750	CONSULT	218
46296	CONSULT	220	CM705	CONSULT	223	CM751	CONSULT	218
46299	CONSULT	221	CM706	CONSULT	223	CM752	CONSULT	218
46302	CONSULT	221	CM707	CONSULT	223	CM753	CONSULT	218
46307	CONSULT	219	CM708	CONSULT	223	CM754	CONSULT	218
46323	CONSULT	220	CM709	CONSULT	223	CM755	CONSULT	220
65351	CONSULT	219	CM710P	CONSULT	224	CM756	CONSULT	222
66219	CONSULT	227	CM711P	CONSULT	224	CM757	CONSULT	218
67297	CONSULT	229	CM712P	CONSULT	224	CM759	CONSULT	224
67497	CONSULT	229	CM713P	CONSULT	224	CM761P	CONSULT	219
69431	CONSULT	229	CM714P	CONSULT	224	CM762P	CONSULT	219
71005	CONSULT	220	CM715L	CONSULT	226	CM763	CONSULT	220
71006	CONSULT	218	CM715L-2	CONSULT	Not Shown	CM764	CONSULT	220
71008	CONSULT	220	CM716	CONSULT	225	CM765	CONSULT	227
89095	CONSULT	226,228	CM716-1	CONSULT	Not Shown	CM766	CONSULT	225
89099	CONSULT	225,228	CM717	CONSULT	225	CM767	CONSULT	227
89102	CONSULT	229	CM718	CONSULT	222	CM768	CONSULT	226
89103	CONSULT	229	CM719	CONSULT	222	CM769	CONSULT	221
89137	CONSULT	229	CM720	CONSULT	222	CM769-2	CONSULT	220
89223	CONSULT	225	CM721	CONSULT	222	CM770P	CONSULT	219
89286	CONSULT	221	CM725P	CONSULT	219	CM771	CONSULT	225
89289	CONSULT	226	CM726	CONSULT	219	CM772L	CONSULT	226
89438	CONSULT	228	CM727	CONSULT	221	CM773	CONSULT	221
89455	CONSULT	222	CM728	CONSULT	221	CM775L	CONSULT	226
89466	CONSULT	228	CM729	CONSULT	221	CM776	CONSULT	221
89728	CONSULT	228	CM730P	CONSULT	224	CM777	CONSULT	220
90815	CONSULT	222	CM731	CONSULT	223	CM778P	CONSULT	220
90836	CONSULT	222	CM732	CONSULT	220	CM779	CONSULT	227
90846	CONSULT	222	CM733	CONSULT	221	CM783	CONSULT	221
91765	CONSULT	228	CM734P	CONSULT	219	CM784L	CONSULT	226
94458	CONSULT	222	CM735P	CONSULT	219	CM785	CONSULT	227
94459	CONSULT	222	CM736	CONSULT	219	CM787	CONSULT	218
109639	CONSULT	224	CM737	CONSULT	227	CM789P	CONSULT	218

*Item obsolete or discontinued. When remaining stock is depleted, published prices are withdrawn and the item is subject to a special order quote.

XX Call for details.



Cardinal Cross Reference By Equivalent Cardinal Number

EQUIV. CARDINAL #	RL PN	PAGE #	EQUIV. CARDINAL #	RL PN	PAGE #	EQUIV. CARDINAL #	RL PN	PAGE #
100-1465	67297	229	0119-C068	CM785	227	1401-B008-2	CM734P	219
0102-C011	156479	226,228	0309-B003	CM773	221	1401-B009-1	CM735P	219
0103-B120-08	89099	225,228	0309-B044 C25	SZ16951	XX	1401-B011-1	CM770P	219
0103-C204-OA	111251	228	0309-C003-3	SZ17269	XX	1411-B004	CM732	220
0105-C071-OA	156480	XX	0309-C007-61	CM776	221	1411-B005	CM755	220
0112-B242-08	89223	225	0309-C008-60	CM783	221	1411-B006	CM769-2	220
0113-B374-08	SZ19209	XX	0309-C149-OA	SZ16950	XX	1411-B007	CM726	219
0119-B127-53	CM719 CM720 CM721	222	0309-0150-OA	SZ16949	XX	1411-B008	CM757	218
0119-B007	CM715L	226	0409-B013	CM769	220,221	1412-B001-3	CM702	XX
0119-B018	CM716	225	0409-B015	CM733	221	1412-B001-5	CM747	223
0119-B019	CM717	225	0409-B027	CM728	221	1412-B001-7	CM731	223
0119-B022	CM749	225	0409-B028	CM727	221	1412-B001-9	CM701	223
0119-B025	CM738	225	0409-B029	CM729	221	1412-B001-13	CM708	223
0119-B026	CM740	225	0409-B040 C10	nose iron	XX	1412-B001-19	CM707	223
0119-B028	CM766	225	0409-B051	nose iron	XX	1412-B012-13	CM708	223
0119-B013-1	CM756	222	0604-B090	71006	218	1417-B001	CM750	218
0119-B103-2	CM718	222	1400-B001-5	CM712P	224	1417-B002	CM787	218
0119-B125-52	CM759	224	1400-B001-9	CM703P	224	1417-B003	CM751	218
0119-B127-52	CM719	222	1400-B001-13	CM710P	224	14SRF	CM771	225
0119-B127-52	CM720	222	1400-B001-19	CM704P	224	16SRF	CM715L	226
0119-B127-52	CM721	222	1400-B001-21	CM748P	224	17SRF	CM717	225
0119-B195	CM784L	226	1400-B001-25	CM713P	224	24SR	CM788	XX
0119-B197	CM749	225	1400-B001-21		XX	26SR	CM768L	XX
0119-C007	CM784L	226	1400-B001-27		XX	27SR	CM766	XX
0119-C008	CM767	227	1400-B001-29	CM730P	224	44SRF	CM741	225
0119-C009	CM765	227	1400-B004	CM761P	219	46SRF	CM775L	226
0119-C010	CM779	227	1400-B005	CM789P	218	47SRF	CM738	225
0119-C011	CM790 SZ5617	XX	1400-B006	CM742P	218	61353-3	CM733	221
0119-C013	CM780	227	1400-B007	CM744P	218	C-37	CM727	221
0119-C014	CM739L	226	1400-B008	CM743P	218	C-38	CM728	221
0119-C016	CM737	227	1400-B009	CM745P	218	C-39	CM729	221
0119-C017	CM768L	XX	1401-B006-1	CM762P	219	C113	CM769	221
0119-C019	CM788	XX	1401-B006-3	CM746P	219	D68	CM733	221
0119-0040	66219	227	1401-B007-2	CM725P	219	2993-B021-08	89728	228
						6020-0060	15263	223



*Item obsolete or discontinued. When remaining stock is depleted, published prices are withdrawn and the item is subject to a special order quote.

XX Call for details.

CARDINAL®

Individual Cardinal Scale Parts

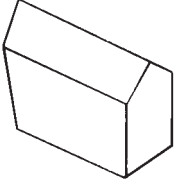
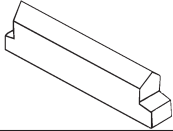
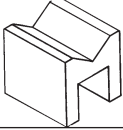
Dormant Scale Parts

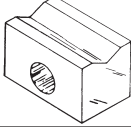
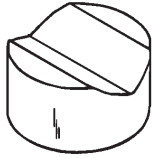
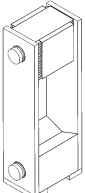
RICE LAKE PN	DESCRIPTION	SUGG. LIST	
CM744P	Equiv. Cardinal no. 1400-B007 Size: 3/8 in x 3/4 in x 1 in Pivot, tapered ends	Consult	
CM742P	Equiv. Cardinal no. 1400-B006 Size: 3/8 in x 3/4 in x 1 1/4 in Pivot	Consult	
CM743P	Equiv. Cardinal no. 1400-B008 Size: 3/8 in x 3/4 in x 1 7/8 in Pivot	Consult	
CM789P	Equiv. Cardinal no. 1400-B005 Size: 3/8 in x 3/4 in x 2 3/8 in Pivot, tapered ends	Consult	
CM745P	Equiv. Cardinal no. 1400-B009 Size: 3/8 in x 3/4 in x 2 3/4 in Pivot	Consult	
CM752	Equiv. Cardinal no. 265 R15 Size: 15/16 in x 15/16 in x 1 in Bearing	Consult	
CM753	Equiv. Cardinal no. 265 R225, 1411-B007 Size: 15/16 in x 15/16 in x 1 in Bearing	Consult	
CM754	Equiv. Cardinal no. 265 R219 Size: 7/8 in x 7/8 in x 11/16 in Bearing	Consult	
CM757	Equiv. Cardinal no. 1411-B008, 265 R217 Size: 15/16 in x 1 3/8 in x 2 1/2 in Hole size: .515 in Bearing	Consult	
CM750	Equiv. Cardinal no. 1400-B001, 265R110 Size: 1 in dia x 9/16 in Bearing	Consult	
CM751	Equiv. Cardinal no. 1417-B003, 265 R21 Size: 1 1/4 in dia x 1 in Bearing	Consult	
CM787	Equiv. Cardinal no. 1417-B002 Size: 2 in dia x 1 3/8 in Bearing	Consult	
71006	Equiv. Cardinal no. 0604-B090 Size: 1 5/8 in x 1 in x 4 1/4 in Center connection	Consult	

Individual Cardinal Scale Parts

Hopper Scale Parts

RICE LAKE PN	DESCRIPTION	SUGG. LIST
CM762P	Equiv. Cardinal no. 1401-B006-1 Size: 3/8 in x 3/8 in x 2 in Pivot	Consult
CM746P	Equiv. Cardinal no. 1401-B006-3 Size: 3/8 in x 3/8 in x 3 in Pivot	Consult
CM725P	Equiv. Cardinal no. 1401-B007-2 Size: 1/2 in x 1/2 in x 3 in Pivot	Consult
CM734P	Equiv. Cardinal no. 1401-B008-2 Size: 5/8 in x 5/8 in x 3 1/2 in Pivot	Consult
CM735P	Equiv. Cardinal no. 1401-B009-1 Size: 3/4 in x 3/4 in x 3 1/2 in pivot	Consult
65351	Equiv. Cardinal no. n/a Size: 3/4 in x 3/4 in x 3 1/2 in Pivot, stainless steel	Consult
CM770P	Equiv. Cardinal no. 1401-B011-1 Size: 1 in x 1 in x 5 in Pivot	Consult
46285	Pivot Size: 1 in dia x 3 1/2 in Use wedge 46286	Consult
CM761P	Equiv. Cardinal no. 1400-B004 Size: 1/4 in x 5/8 in x 7/8 in Pivot	Consult
46307	Equiv. Cardinal no. n/a Size: 1/4 in x 5/8 in x 7/8 in Pivot, stainless steel	Consult
CM726	Equiv. Cardinal no. 1411-B007 Size: 1 in x 7/8 in x 1 1/8 in Hole size: 21/64 in Bearing	Consult
CM736	Equiv. Cardinal no. n/a Size: 1 1/4 in x 1 in x 1 1/4 in Hole size: 25/64 in Bearing	Consult
89455	Equiv. Cardinal no. 0409-C017-OA Size: 1 1/4 in x 2 1/4 in x 9 3/8 in Center connection	Consult

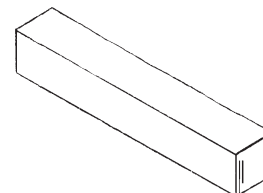

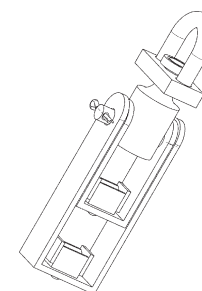
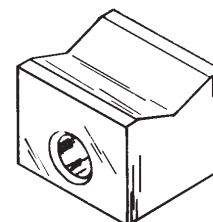
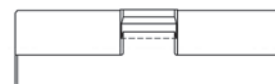

Must measure the size of old pivot with a micrometer. We will grind to size for CONSULT3.00 each

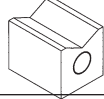

Individual Cardinal Scale Parts

Hopper Scale Parts (Cont.)

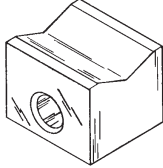
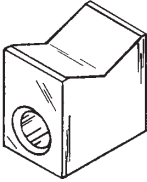
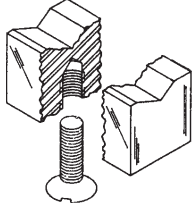
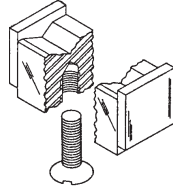
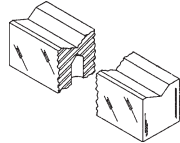
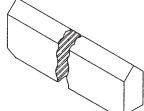
RICE LAKE PN	DESCRIPTION	SUGGESTED LIST	
71005	Equiv. Cardinal no. n/a Size: 1 in x 1 in x 1 1/4 in	Consult	
71008	Equiv. Cardinal no. n/a Size: 1 in x 1 1/4 in x 1 1/8 in With frictions	Consult	
CM755	Equiv. Cardinal no. 1411-B005 Size: 1 3/8 in x 15/16 in x 1 5/16 in Bearing	Consult	
46323	Equiv. Cardinal no. n/a Size: 1 3/8 in x 15/16 in x 1 5/16 in Bearings, stainless steel	Consult	
44793	Equiv. Cardinal no. n/a Size: 1 3/8 in x 1 3/8 in x 1 5/16 in Hole size: 3/8 in Bearing	Consult	
CM769-2	Equiv. Cardinal no. 1411-B006 Size: 1 3/4 in x 1 1/2 in x 1 13/16 in Hole size: 5/8 in Bearing	Consult	
CM732	Equiv. Cardinal no. 1411-B004 Size: 25/32 in x 25/32 in x 17/32 in Hole size: 1/4 in - offset Bearing	Consult	
CM763	Equiv. Cardinal no. n/a Size: 3/4 in x 3/4 in x 1 in Hole size: 1/4-20 thread Bearing Screw not included Use screw, Rice Lake PN 22005	Consult	
CM764 46296	Equiv. Cardinal no. n/a Size: 3/4 in x 3/4 in x 1 1/4 in SST Hole size: 1/4-20 thread Bearing, with friction plates Screw not included Use screw, Rice Lake PN 22005	Consult Consult	
CM777	Equiv. Cardinal no. n/a Size: 3/4 in x 3/4 in x 4 5/8 in Hole size: 1/4 in dia	Consult	
CM778P	Equiv. Cardinal no. n/a Size: 3/8 in x 3/4 in x 4 5/8 in Pivot	Consult	

Individual Cardinal Scale Parts

Hopper Scale Parts (Cont.)

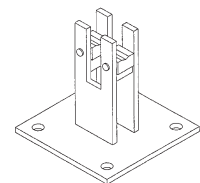
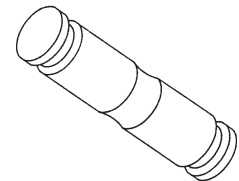
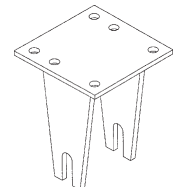
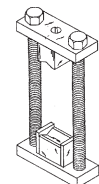
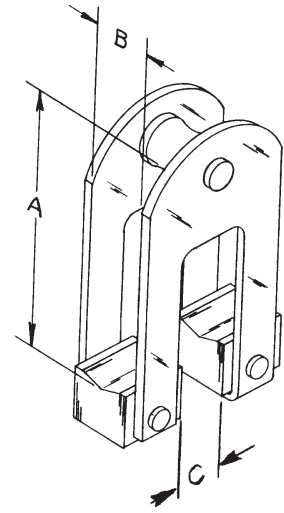

RICE LAKE PN	DESCRIPTION	SUGG. LIST
CM728	Equiv. Cardinal no. C-38, 0409-B027 Size: A. 2 in B. 3/4 in C. 9/16 in Assembly includes CM732 bearings And Rice Lake PN 15266 pins	Consult
CM727	Equiv. Cardinal no. C-37, 0409-B028 Size: A. 3 1/8 in B. 1 in C. 9/16 in Assembly includes Rice Lake PN CM726 Bearings and Rice Lake PN 22100 pins	Consult
CM729	Equiv. Cardinal no. C-39, 0409-B029 Size: A. 4 in B. 1 3/8 in C. 1 in Assembly includes Rice Lake PN CM755 Bearings and Rice Lake PN 15295 pins Cotter pin pn15232	Consult
46299	Equiv. Cardinal no. C-39, 0409-B029 Size: A. 4 in B. 1 3/8 in C. 1 in assembly includes bearing PN 46323 and pin PN 47992 stainless steel	Consult
89286	Equiv. Cardinal no. Size A. 3 13/16 in B. 1 3/8 in C. 1 in New style CM729 with taller Bearings, PN 44793	Consult
CM769	Equiv. Cardinal no. C113, 0409-B013 Size: A. 4 1/4 in B. 1 3/4 in C. 1 1/2 in Assembly includes Rice Lake PN CM769-2 Bearings and Rice Lake PN 15306 pins	Consult
CM733	Equiv. Cardinal no. D68, 61353-3, 0409-B015 Size of plate: 1 in x 3/8 in x 2 3/4 in Size of bearing: 3/4 in x 3/4 in x 1 in Size of bolt: 3/8 in - 16 in x 6 in Upper bearing: Rice Lake PN CM763 Lower bearing: Rice Lake PN CM764	Consult
CM776	Equiv. Cardinal no. 0309-C007-61 Base: 8 in x 8 in Total height: 10 1/2 in FS2.5, FS3, FS4 See page xxx for other chair	Consult
CM773	Equiv. Cardinal no. 0309-B003 Size: 1 1/4 in dia x 5 1/4 in Trunnion pin FS2.5, FS3, FS4	Consult
46302	Equiv. Cardinal no. Size: 1 1/4 in dia x 5 1/4 in SST Trunnion pin FS2.5, FS3, FS4	Consult
CM783	Equiv. Cardinal no. 0309-C008-60 Base: 8 in x 8 in Total height: 8 in Assembly includes Rice Lake PN CM755 Bearings and Rice Lake PN 15297 pins FS2.5, FS3, FS4 See page 328 for other stands	Consult



CARDINAL®

Individual Cardinal Scale Parts

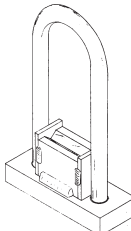
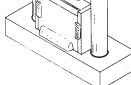
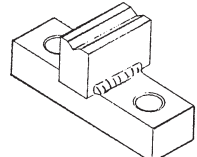
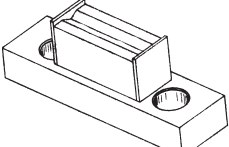
Truck Scale Parts

RICE LAKE PN	DESCRIPTION	SUGGESTED LIST	
CM718	Equiv. Cardinal no. 0119-B103-2 Size: bearing, 1 5/8 in long 3 1/4 in loop length, inside Transverse lever tip loop	Consult	
CM756	Equiv. Cardinal no. 0119-B103-1 Size: bearing, 2 1/8 in long 3 1/2 in inside loop length Transverse lever tip loop	Consult	
CM719	Equiv. Cardinal no. 0119-B127-52 Size: bearing, 2 1/8 in long Total length 5 in Between holes 3 1/4 in center to center Hole size: 11/16 in Upper center connection	Consult	
CM720	Equiv. Cardinal no. 0119-B127-52 Size: bearing, 2 1/8 in long Total length 5 in Between holes 3 1/4 in center to center Hole size: 11/16 in Lower center connection	Consult	
*CM721	Equiv. Cardinal no. 0119-B127-52 Size: 5/8 in in dia x 18 in long Main lever shackle bolt Other bolts listed below	Consult	

*OTHER BOLTS AVAILABLE

RICE LAKE PN	DESCRIPTION	SUGGESTED LIST
154030.....	1/2 in - 13 x 16 in	Consult
90846.....	5/8 in - 11 x 8 in	Consult
90836.....	5/8 in - 11 x 13 in	Consult
90815.....	5/8 in - 11 x 16 in	Consult
CM721	5/8 in - 11 x 18 in	Consult
154029.....	3/4 in - 10 x 12 in	Consult
94458.....	3/4 in - 10 x 15 in	Consult
94459.....	3/4 in - 10 in x 21 in.....	Consult
.....	7/8 in - 9 in x 19 in.....	CONSULT

*Item obsolete or discontinued. When remaining stock is depleted, published prices are withdrawn and the item is subject to a special order quote.

XX Call for details.

Individual Cardinal Scale Parts

Truck Scale Parts (Cont.)

RICE LAKE PN	DESCRIPTION	SUGGESTED LIST
CM705	Equiv. Cardinal no. n/a Size: 1 in x 1 in x 1 1/2 in long Bearing	Consult
CM706	Equiv. Cardinal no. n/a Size: 1 in x 1 in x 1 3/4 in long Bearing	Consult
CM701	Equiv. Cardinal no. 1412-B001-9 Size: 1 in x 1 in x 2 in long Bearing	Consult
CM707	Equiv. Cardinal no. 1412-B001-19 Size: 1 in x 1 in x 4 in long Bearing	Consult
CM708	Equiv. Cardinal no. 1412-B001-13 Size: 1 in x 1 in x 5 in long Bearing	Consult
CM702	Equiv. Cardinal no. 1412-B001-3 Size: 1 in x 1 in x 6 in long Bearing	Consult
CM709	Equiv. Cardinal no. n/a Size: 1 in x 1 in x 7 in long Bearing	Consult
CM747	Equiv. Cardinal no. 1412-B001-5 Size: 1 in x 1 in x 8 in long Bearing	Consult
CM731	Equiv. Cardinal no. 1412-B001-7 Size: 1 in x 1 in x 10 in long Bearing	Consult
15274	Equiv. Cardinal no. n/a Size: 5/16 in dia x 3/4 in Roll pin	Consult
15263	Equiv. Cardinal no. n/a Size: 1/4 in dia x 3/4 in Roll pin	Consult
15285	Equiv. Cardinal no. Na Size: 3/8 in dia x 1 in Roll pin	Consult

HOLE SIZE ON ALL BEARINGS
5/16 in DIAMETER

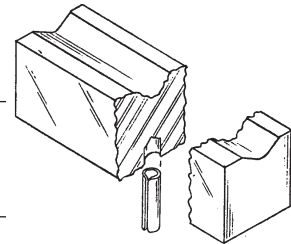

PIN SOLD SEPARATELY
BELOW



Individual Cardinal Scale Parts

Truck Scale Parts (Cont.)

CARDINAL®

RICE LAKE PN	DESCRIPTION	SUGGESTED LIST
CM710P	Equiv. Cardinal no. 1400-B001-13 Size: 1/2 in x 1 1/8 in x 1 1/2 in long Pivot:	Consult
109639	0.484 in x 1 in x 1 1/2 in	Consult
CM711P	Equiv. Cardinal no. n/a Size: 1/2 in x 1 1/8 in x 1 3/4 in long Pivot:	Consult
CM703P	Equiv. Cardinal no. 1400-B001-9 Size: 1/2 in x 1 1/8 in x 2 in long Pivot:	Consult
109640	0.484 in x 1 in x 2 in	Consult
CM712P	Equiv. Cardinal no. 1400-B001-5 Size: 1/2 in x 1 1/8 in x 3 7/8 in long Pivot:	Consult
109641	0.484 in x 1 in x 3 7/8 in	Consult
CM713P	Equiv. Cardinal no. 1400-B001-25 Size: 1/2 in x 1 1/8 in x 5 in long Pivot:	Consult
109642	0.484 in x 1 in x 5 in	Consult
CM704P	Equiv. Cardinal no. 1400-B001-19 Size: 1/2 in x 1 1/8 in x 6 in long Pivot:	Consult
109643	0.484 in x 1 in x 6 in	Consult
*CM714P	Equiv. Cardinal no. n/a Size: 1/2 in x 1 1/8 in x 7 in long Pivot:	Consult
CM748P	Equiv. Cardinal no. 1400-B001-21 Size: 1/2 in x 1 1/8 in x 8 in long Pivot:	Consult
109644	0.484 in x 1 in x 8 in	Consult
CM730P	Equiv. Cardinal no. 1400-B001-29 Size: 1/2 in x 1 1/8 in x 10 in long Pivot:	Consult
CM759	Equiv. Cardinal no. 0119-B125-52 Size: 1 3/4 in x 4 in x 15 in long Shackle	Consult

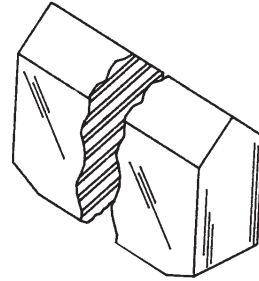

**ALL PIVOTS ARE
0.495 in W x 1.125 in H**
When ordering, measure
height and thickness. This
may vary. CONSULT \$3.00 net
charge each for grinding
to size.

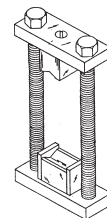



*Item obsolete or discontinued. When remaining stock is depleted, published prices are withdrawn and the item is subject to a special order quote.

XX Call for details.

Individual Cardinal Scale Parts

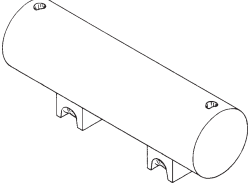
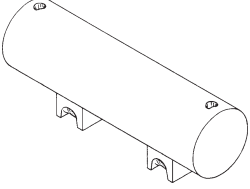
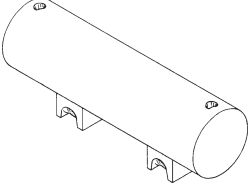
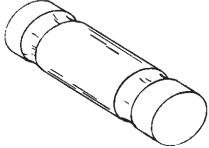
Truck Scale Parts (Cont.)

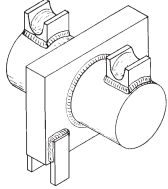
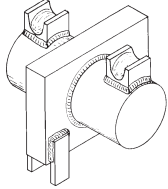
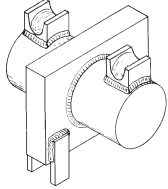
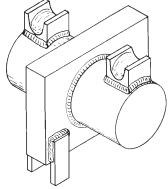
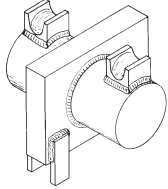
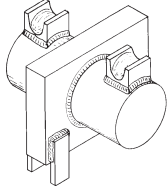
RICE LAKE PN	DESCRIPTION	SUGGESTED LIST	
CM738	Equiv. Cardinal no. 0119-B025, 47SRF Size: 1 3/4 in dia x 8 1/4 in long Use with CM740 or CM741 Trunnion (link pin)	Consult	
CM717	Equiv. Cardinal no. 0119-B019, 17SRF Size: 2 in dia x 9 1/4 in long Use with CM716, CM771, or CM749 Trunnion (link pin)	Consult	
CM766	Equiv. Cardinal no. 27SR and 0119-B028 Size: 1 1/4 in dia x 6 3/8 in long Use with CM788 and CM768L Trunnion (link pin)	Consult	
89099	Equiv. Cardinal no. 0103-B120-08 Size: 2 1/2 in dia x 11 1/4 in Trunnion old style; model EPR	Consult	
89223	Equiv. Cardinal no. 0112-B242-08 Size: 6 in x 4 1/2 in x 27 3/4 in Trunnion; model LPL	Consult	
CM740	Equiv. Cardinal no. 0119-B026 Size: 5 3/4 in x 3/8 in x 4 1/2 in Welded on tabs to hold bearing Use bearing CM708 and link CM739L Type A	Consult	
CM741	Equiv. Cardinal no. 44SRF Size: 5 3/4 in x 2 5/8 in x 4 1/2 in Machined slot to hold bearing Use bearing CM708 and link CM775L Type B	Consult	
CM716	Equiv. Cardinal no. 0119-B018, 14SRF Size: 5 3/4 in x 4 in x 5 1/2 in Welded on tabs to hold bearing Use bearing CM702 and link CM715L Type A	Consult	
CM771	Equiv. Cardinal no. 14SRF Size: 5 3/4 in x 3 1/4 in x 5 1/2 in Machined slot to hold bearing Use bearing CM702 and link CM772L Type A	Consult	
CM749	Equiv. Cardinal no. 0119-B022, 0119-B197 Size: 5 3/4 in x 4 in x 7 1/2 in Welded on tab to hold bearing Use bearing CM747 and link CM784L Type A	Consult	
10029	Equiv. Cardinal no. 24SR and 0119-C019 Size: 4 1/4 in x 2 in x 3 3/8 in Use with CM766 and CM768L Type B (casting)	Consult	

CARDINAL®

Individual Cardinal Scale Parts

Truck Scale Parts (Cont.)

CARDINAL®

RICE LAKE PN	DESCRIPTION	SUGGESTED LIST
CM739L	Equiv. Cardinal no. 0119-C014 Size: 5/8 in x 4 1/8 in x 12 3/8 in Inside length: 8 3/4 in Use with saddle block CM740	Consult
CM775L	Equiv. Cardinal no. 46SRF Size: 5/8 in x 4 1/4 in x 11 3/8 in Inside length: 7 3/4 in Use with saddle block CM741	Consult
CM715L	Equiv. Cardinal no. 0119-B007,16SRF Size: 5/8 in x 4 7/8 in x 13 3/8 in Inside length: 9 1/2 in Use with saddle block CM716	Consult
CM772L	Equiv. Cardinal no. n/a Size: 5/8 in x 5 in x 12 5/16 in Inside length: 8 3/4 in Use with saddle block CM771	Consult
CM784L	Equiv. Cardinal no. 0119-C007, 0119-B195 Size: 5/8 in x 6 in x 14 1/4 in Inside length: 9 3/8 in Use with saddle block CM749	Consult
CM768	Equiv. Cardinal no. 26SR and 0119-C017 Size: 1/2 in x 3 5/8 in x 10 1/4 in Inside length: 7 1/4 in Use with saddle block CM788	Consult
89289	Equiv. Cardinal no. 0112-C246-OA Size: 5/8 in x 5 in x 14 1/2 in Inside length: 10 3/4 in Link models LP	Consult
156479	Equiv. Cardinal no. 102-C019A Size: 5/8 in x 5 in x 10 in Inside length: 6 in Link model EPR, 35k load cells	Consult
89095	Equiv. Cardinal no. 0103-C121-OA Size: 3/4 in x 6 in x 12 in Inside length: 7 in Link, model EPR, 50K CELLS	Consult
156480	Equiv. Cardinal no. 0105-C071-OA Size: 1 in x 6 in x 12 in Inside length: 7 in Link model EPR, 75k load cells	Consult

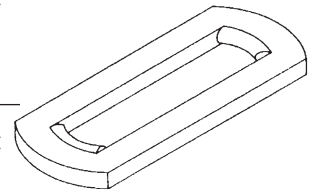
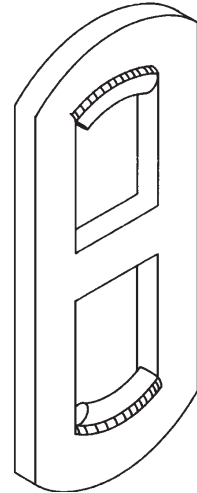

Individual Cardinal Scale Parts

Truck Scale Stands and Chairs

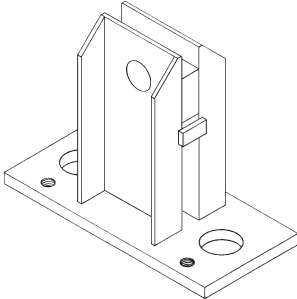
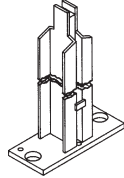
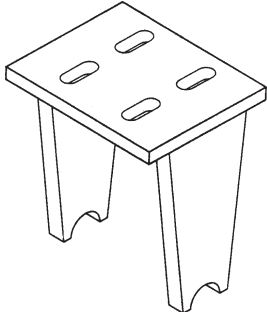
RICE LAKE PN	DESCRIPTION	SUGGESTED LIST	
CM737	Equiv. Cardinal no. 0119-C016 Base: 6 in x 13 in x 10 1/2 in Height: 9 3/8 in to bearing For 5 in bearing, CM708 Used in 20- and 25-ton, two-section 40-Ton, 3 section scale scales; stand	Consult	
CM765	Equiv. Cardinal no. 0119-C009 Base: 8 in x 14 in Height: 12 1/2 in For 6 in bearing, CM702 Used in 30-, 50- and 60-ton scales; stand	Consult	
CM779	Equiv. Cardinal no. 0119-C010 Base: 8 in x 14 in Height: 12 1/2 in For 8 in bearing, CM747 Used in 80-ton scale; stand	Consult	
66219	Equiv. Cardinal no. 0119-C040 Size: 5 in x 8 in x 6 in For PV scales	Consult	
CM785	Equiv. Cardinal no. 0119-C068 Base: 6 in x 14 in Height, total: 23 in Torque tube stand	Consult	
CM767	Equiv. Cardinal no. 0119-C008 Base: 8 in x 10 in Height: 12 1/4 in Use with CM717 trunnion pin Used in 30-ton, 2 section, 50-, 60- And 80-ton, 2, 4 and 5 section scales Chair	Consult	



CARDINAL®

*Item obsolete or discontinued. When remaining stock is depleted, published prices are withdrawn and the item is subject to a special order quote.

XX Call for details.

Individual Cardinal Scale Parts

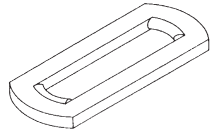
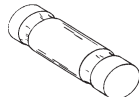
Model EPR Truck Scale

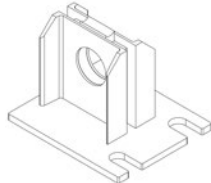
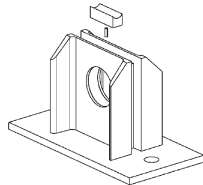
RICE LAKE PN	DESCRIPTION	SUGGESTED LIST	
156479	Equiv. Cardinal no. 102-C019A Size: 5/8 in x 5 in x 10 in Inside length: 6 in Link model EPR 35k load cells	CONSULT	
89095	Equiv. Cardinal no. 0103-C121-OA Size: 3/4 in x 6 in x 12 in Link 7 in id 50k load cell	Consult	
156480	Equiv. Cardinal no. 0105-C071-OA Size: 1 in x 6 in x 12 in Inside length: 7 in Link model epr 75k load cells	Consult	
89099	Equiv. Cardinal no. 0103-B120-08 Size: 2 1/2 in dia x 11 1/4 in Trunnion	Consult	
89438	Equiv. Cardinal no. 2993-B036-08 Size: 1 1/4 in dia x 3 5/8 in Rocker pivot	Consult	
89466	Equiv. Cardinal no. 0103-C127-OA Size: 11 in x 13 in x 9 in high Stand side access With bearing insert PN 89728	Consult	
111251	Equiv. Cardinal 0103-C204-OA Size: 11 in x 13 in x 9 in high Stand, top access With bearing insert PN 89728	Consult	
89728	Equiv. Cardinal no. 2993-B021-08 bearing 1 in x 1 in x 3 in	Consult	
91765	Equiv. Cardinal no DB50000S Load cell 50k	Consult	

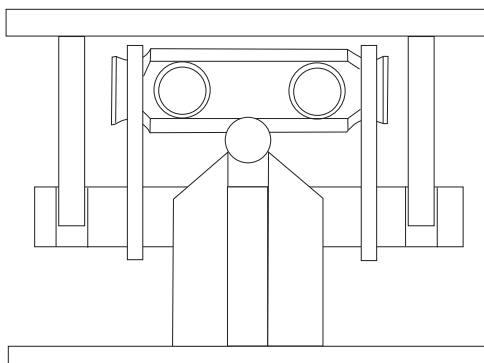

Cardinal Diagram

NOTE: Diagram not to scale

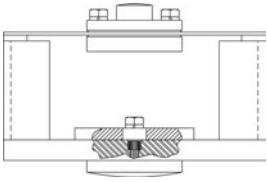
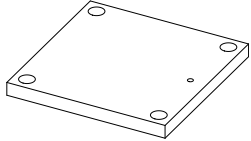
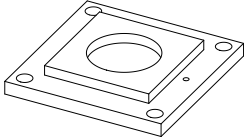
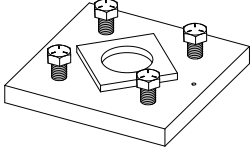
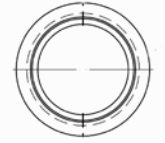

Individual Cardinal Scale Parts

Electronic Truck Scale

RICE LAKE PN	DESCRIPTION	SUGGESTED LIST	
67297	Equiv. Cardinal no. 100-1465 Size: 6 in W x 7 5/16 in H x 11 in L Load cell box	Consult	
89102	Equiv. Cardinal no. Size: 1/2 in x 6 in x 6 in Top plate, no retainer	Consult	
89103	Equiv. Cardinal no. 0146-B018-OA Size 1/2 in x 6 in x 6 in Top plate For truck scales with SCA 50 k Load cells	Consult	
89137	Equiv. Cardinal no. Size: 1 in x 9 in x 9 in Base plate with leveling lugs For truck scales with SCA 50 k Load cells	Consult	
69431	Equiv. Cardinal no. Size: 2 1/4 in dia x 13/16 in tall Load cups with o-ring For truck scales with SCA 50 k Load cells	Consult	
67497	Equiv. Cardinal no. 3501-B034 Size: 3/4 in thick x 4 in dia Button at top of this page For bottom of PN 67297	Consult	

CARDINAL®

CARDINAL KITS

CARDINAL®

Cardinal Kit Price Index By Rice Lake PN

RL PN	SUGGESTED LIST	PAGE #	RL PN	SUGGESTED LIST	PAGE #	RL PN	SUGGESTED LIST	PAGE #
CM-751-K	CONSULT	236	CM-759-K	CONSULT	240	CM-767-K	CONSULT	241
CM-752-K	CONSULT	236	CM-760-K	CONSULT	238	CM-768-K	CONSULT	241
CM-753-K	CONSULT	237	CM-761-K	CONSULT	237	CM-769-K	CONSULT	239
CM-754-K	CONSULT	237	CM-762-K	CONSULT	237	CM-770-K	CONSULT	239
CM-755-K	CONSULT	238	CM-763-K	CONSULT	236	CM-771-K	CONSULT	239
CM-756-K	CONSULT	240	CM-764-K	CONSULT	236			
CM-757-K	CONSULT	242	CM-765-K	CONSULT	243			
CM-758-K	CONSULT	242	CM-766-K	CONSULT	243			

Cardinal Kit Reference By Capacity

CAPACITY	RICE LAKE PN	PAGE #	CAPACITY	RICE LAKE PN	PAGE #	CAPACITY	RICE LAKE PN	PAGE #
Pivot and Bearing Kits			Suspension Kits			Dormant Scales		
15 TON	CM-751-K	236	15 TON	CM-764-K	236	6,500 LB	CM-765-K	243
20 AND 25 TON	CM-752-K	236	20 AND 25 TON	CM-763-K	236	12,000 LB	CM-766-K	243
30 TON	CM-753-K	237	30 TON	CM-762-K	237	50 AND 60 TON	CM-767-K	241
40 TON	CM-754-K	237	40 TON	CM-761-K	237	50 AND 60 TON	CM-768-K	241
50 TON	CM-755-K	238	50 TON	CM-760-K	238	50 TON	CM-769-K	239
50 AND 60 TON	CM-756-K	240	50 AND 60 TON	CM-759-K	240	50 TON	CM-770-K	239
80 TON	CM-757-K	242	80 TON	CM-758-K	242	50 TON	CM-771-K	239

Cardinal Truck Scale Profile

Typical Height Dimensions

SR MECHANICAL PIT TYPE

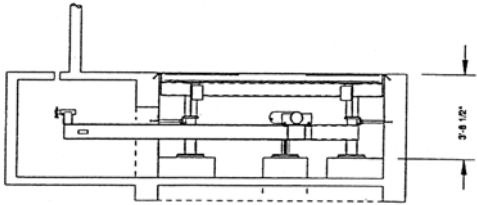

SRICE LAKE MECHANICAL PIT TYPE WITH SINGLE LOAD CELL

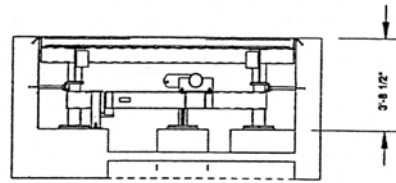

PR MECHANICAL PORTABLE TYPE

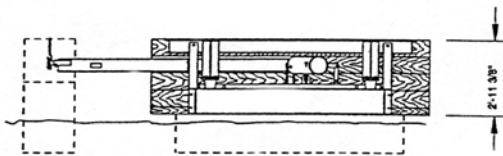

PRICE LAKE MECHANICAL PORTABLE TYPE WITH SINGLE LOAD CELL

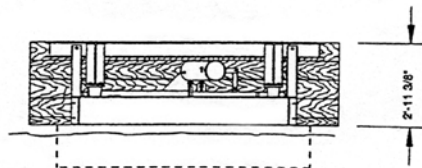

LP-2 MECHANICAL LOW PROFILE WITH STEEL DECK

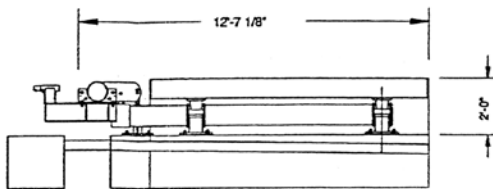

LP-2C MECHANICAL LOW PROFILE WITH CONCRETE DECK

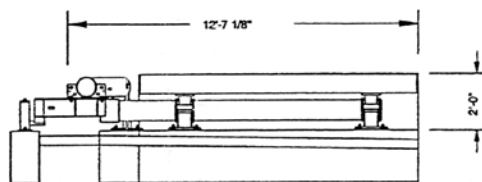

Cardinal Truck Scale Profile

Typical Height Dimensions

CARDINAL®

LPL-3 MECHANICAL LOW PROFILE, FLAT TOP, SINGLE LOAD CELL

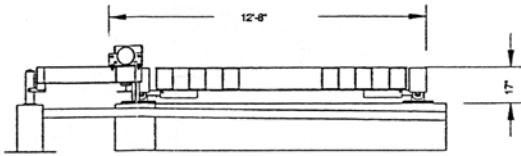

EPR ELECTRONIC LOW PROFILE PORTABLE

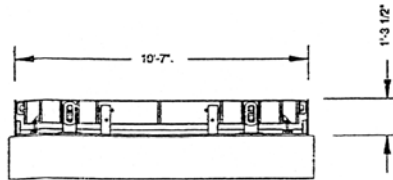

SRC ELECTRONIC PIT TYPE

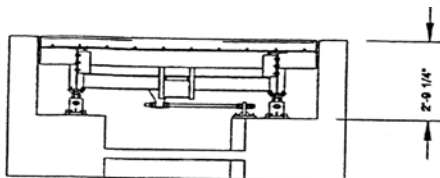

PRC-H ELECTRONIC LOW PROFILE WITH HIPS

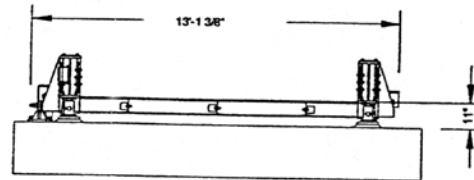

PRC-1 ELECTRONIC LOW PROFILE, FLAT TOP, STEEL DECK

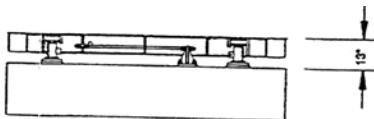

PRC-1-C ELECTRONIC LOW PROFILE FLAT TOP CONCRETE DECK

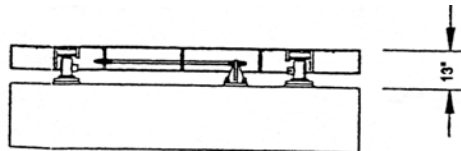

Cardinal Motor Truck Scale

REFERENCE SHEET

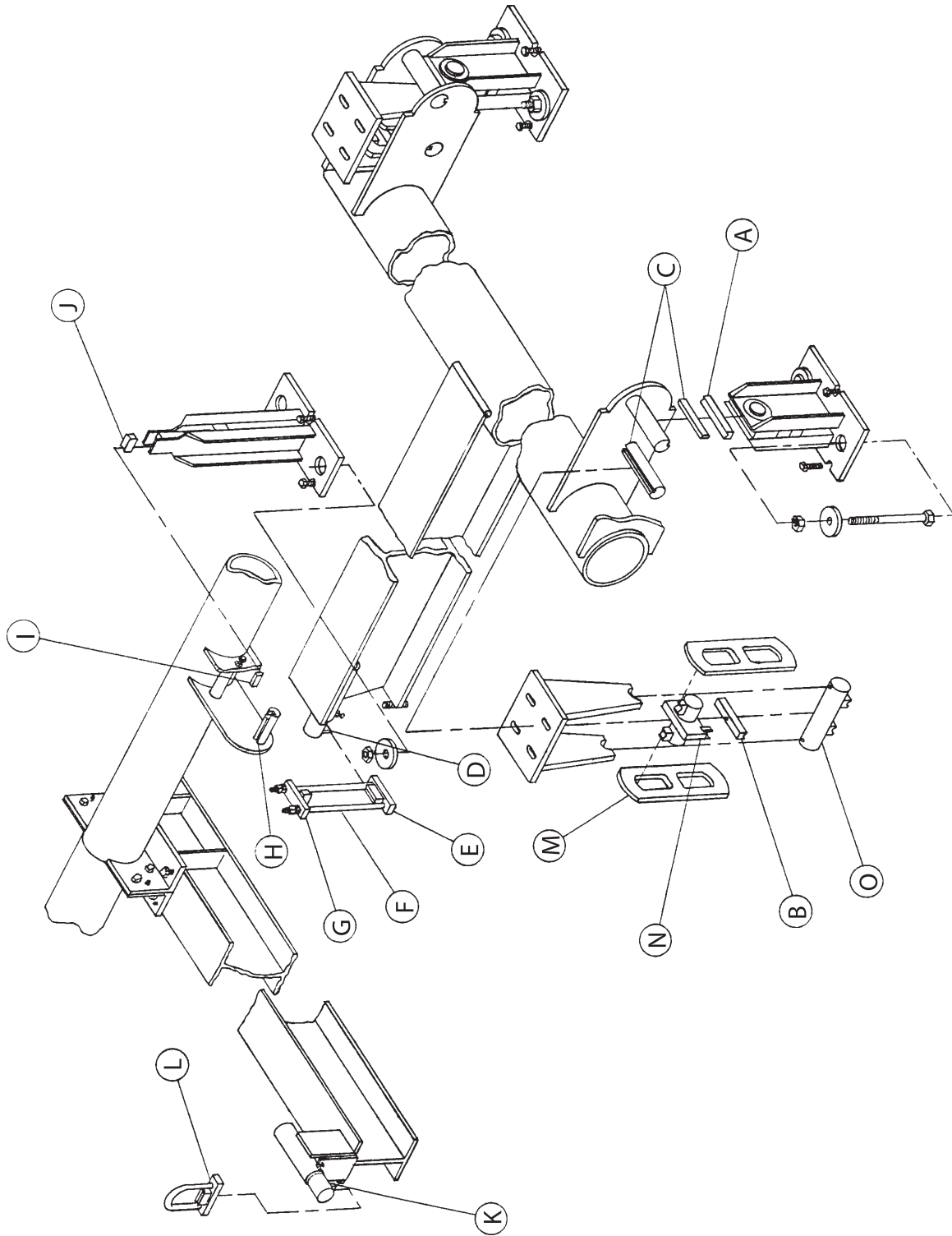

MEASURE LOAD OR FULCRUM PIVOT HEIGHT AND WIDTH BEFORE ORDERING

CARDINAL®

Truck Scale

CARDINAL®

Kit No. CM-751-K

Pivot and Bearing Kit For Model 1522SR, 2-Section, 15-Ton, 22-Ft. Truck Scale* SR, SRice Lake, PR and PRice Lake

REF #	QTY	RICE LAKE PN	EQUIV. CARDINAL #	DESCRIPTION
A	4	CM707	1412-B001-19	Bearing, fulcrum
B	4	CM707	1412-B001-19	Bearing, load
C	8	CM712P	1400-B001-5	Pivot, load and fulcrum
D	2	CM710P	1400-B001-13	Pivot, tip
E, F, G	2	CM758	0119-B125-51	Shackle assembly
H	2	CM712P	1400-B001-5	Pivot, load
I	2	CM703P	1400-B001-9	Pivot, fulcrum
J	2	CM701	1412-B001-9	Bearing, fulcrum
K	1	CM710P	1400-B001-13	Pivot, tip
L	1	CM718	0119-B103-2	Loop, tip

**ALL PIVOTS ARE
0.495 in W x 1.125 in H**
When ordering, measure height and thickness. This may vary. **CONSULT 3.00 net charge each for grinding to size.**

Consult Suggested list/32 lb shipping weight

Kit No. CM-764-K

Suspension Kit For CM-751-K

REF #	QTY	RICE LAKE PN	EQUIV. CARDINAL #	DESCRIPTION
M	8	CM768	0119-C017 (26SR)	Link
N	4	CM788	0119-C019 (24SR)	Saddle block
O	4	CM766	0119-B028	Trunnion

Consult Suggested list/47 lb shipping weight

Kit No. CM-752-K

Pivot and Bearing Kit For Models 2024SR, 2010 APL Axle Load 2034SR, 2524SR, 2-Section, 20-Ton, 24- and 34-Ft. Truck Scale, 2-Section, 25-Ton, 24-Ft. Truck Scale* SR, SRice Lake, PR and PRice Lake

REF #	QTY	RICE LAKE PN	EQUIV. CARDINAL #	DESCRIPTION
A	4	CM708	1412-B001-13	Bearing, fulcrum
B	4	CM708	1412-B001-13	Bearing, load
C	8	CM713P	1400-B001-25	Pivot, lead and fulcrum
D	2	CM710P	1400-B001-13	Pivot, tip
E, F, G	2	CM759	0119-b125-52	Shackle assembly
H	2	CM712P	1400-B001-5	Pivot, load
I	2	CM703P	1400-B001-9	Pivot, fulcrum
J	2	CM701	1412-B001-9	Bearing, fulcrum
K	1	CM710P	1400-B001-13	Pivot, tip
L	1	CM718	0119-b103-2	Loop, tip

**ALL PIVOTS ARE
0.495 in W x 1.125 in H**
When ordering, measure height and thickness. This may vary. **CONSULT 3.00 net charge each for grinding to size.**

Consult Suggested list/36 lb shipping weight

Kit No. CM-763-K

Suspension Kit For CM-752-K

REF #	QTY	RICE LAKE PN	EQUIV. CARDINAL #	DESCRIPTION
M	8	CM739L	0119-C014	Link
N	4	CM740	0119-B026	Saddle block
O	4	CM738	0119-B025, 47SRF	Trunnion

Consult Suggested list/100 lb shipping weight

* Measure load or fulcrum pivot height and width before ordering.

Truck Scale

Kit No. CM-753-K

Pivot and Bearing Kit For Models 3024SR, 3034SR, 2-Section, 30-Ton, 24- and 34-Ft. Truck Scale SR, SRice Lake, PR and PRice Lake

REF #	QTY	RICE LAKE PN	EQUIV. CARDINAL #	DESCRIPTION
A	4	CM702	1412-B001-3	Bearing, fulcrum
B	4	CM702	1412-B001-3	Bearing, load
C	8	CM704P	1400-B001-19	Pivot, load and fulcrum
D	2	CM703P	1400-B001-9	Pivot, tip
E	2	CM720	0119-B127-52	Bearing, lower shackle
F	4	CM721	0119-B127-52	Bolt, shackle
G	2	CM719	0119-B127-52	Bearing, upper shackle
H	2	CM712P	1400-B001-5	Pivot, load
I	2	CM703P	1400-B001-9	Pivot, fulcrum
J	2	CM701	1412-B001-9	Bearing, fulcrum
K	1	CM703P	1400-B001-9	Pivot, tip
L	1	CM756	0119-b103-1	Loop, tip

**ALL PIVOTS ARE
0.495 in W x 1.125 in H**
When ordering, measure height and thickness. This may vary. **CONSULT3.00 net charge each for grinding to size.**

Consult Suggested list/40 lb shipping weight

Kit No. CM-762-K

Suspension Kit For CM-753-K

REF #	QTY	RICE LAKE PN	EQUIV. CARDINAL #	DESCRIPTION
M	8	CM715L	0119-B007 (16SRF)	Link
N	4	CM716	0119-B018 (14SRF)	Saddle block
O	4	CM717	0119-B019 (17SRF)	Trunnion

Consult Suggested list/140 lb shipping weight

Kit No. CM-754-K

Pivot and Bearing Kit For Model 4040SR, 3-Section, 40-Ton, 40-Ft. Truck Scale* SR, Rice Lake, PR and Rice Lake

REF #	QTY	RICE LAKE PN	EQUIV. CARDINAL #	DESCRIPTION
A	6	CM708	1412-B001-13	Bearing, fulcrum
B	6	CM708	1412-B001-13	Bearing, load
C	12	CM713P	1400-B001-25	Pivot, load and fulcrum
D	3	CM710P	1400-B001-13	Pivot, tip
E, F, G	3	CM760	0119-B125-53	Shackle assembly
H	3	CM712P	1400-B001-5	Pivot, load
I	3	CM703P	1400-B001-9	Pivot, fulcrum
J	3	CM701	1412-B001-9	Bearing, fulcrum
K	1	CM703P	1400-B001-9	Pivot, tip
L	1	CM756	0119-B103-1	Loop, tip

**ALL PIVOTS ARE
0.495 in W x 1.125 in H**
When ordering, measure height and thickness. This may vary. **CONSULT3.00 net charge each for grinding to size.**

Consult Suggested list/54 lb shipping weight

Kit No. CM-761-K

Suspension Kit For CM-754-K

REF#	QTY	RICE LAKE PN	EQUIV. CARDINAL #	DESCRIPTION
M	12	CM739L	0119-C014	Link
N	6	CM740	0119-B026	Saddle block
O	6	CM738	0119-B025 (47SRF)	Trunnion

Consult Suggested list/133 lb shipping weight

* Measure load or fulcrum pivot height and width before ordering.

Truck Scale

CARDINAL®

Kit No. CM-755-K

Pivot and Bearing Kit For Model 5045SR, 3535 SR, 3540 SR, 3-Section,
50-Ton, 45-Ft. Truck Scale*, SR, SRice Lake, PR and PRice Lake

REF #	QTY	RICE LAKE PN	EQUIV. CARDINAL #	DESCRIPTION
A	6	CM702	1412-B001-3	Bearing, fulcrum
B	6	CM702	1412-B001-3	Bearing, load
C	12	CM704P	1400-B001-19	Pivot, load and fulcrum
D	3	CM703P	1400-B001-9	Pivot, tip
E	3	CM720	0119-B127-52	Bearing, lower shackle
F	6	CM721	0119-B127-52	Bolts, shackle
G	3	CM719	0119-B127-52	Bearing, upper shackle
H	3	CM712P	1400-B001-5	Pivot, load
I	3	CM703P	1400-B001-9	Pivot, fulcrum
J	3	CM701	1412-B001-9	Bearing, fulcrum
K	1	CM703P	1400-B001-9	Pivot, tip
L	1	CM756	0119-B103-1	Loop, tip

ALL PIVOTS ARE
0.495 in W x 1.125 in H
When ordering, measure height and thickness. This may vary. CONSULT 3.00 net charge each for grinding to size.

Consult Suggested list/60 lb shipping weight

Kit No. CM-760-K

Suspension Kit For CM-755-K

REF #	QTY	RICE LAKE PN	EQUIV. CARDINAL #	DESCRIPTION
M	12	CM715L	0119-B007(16SRF)	Link
N	6	CM716	0119-B018(14SRF)	Saddle block
O	6	CM717	0119-B019(17SRF)	Trunnion

Consult Suggested list/200 lb shipping weight

* Measure load or fulcrum pivot height and width before ordering.

Truck Scale

Kit No. CM-769-K

Pivot and Bearing Kit, 5-Section, 50- and 60-Ton, Truck Scale With 5 in Load Fulcrum

REF #	QTY	RICE LAKE PN	EQUIV. CARDINAL #	DESCRIPTION
A	10	CM708	1412-B001-13	Bearing, fulcrum
B	10	CM708	1412-B001-15	Bearing, load
C	20	CM713P	1400-B001-25	Pivot, load and fulcrum
D	5	CM710P	1400-B001-13	Pivot, tip
E,F,G	5	CM759	0119-B125-52	Shackle assembly
H	5	CM712P	1400-B001-5	Pivot, load
I	5	CM703P	1400-B001-9	Pivot, fulcrum
J	5	CM701	1412-B001-9	Bearing, fulcrum
K	1	CM710P	1400-B001-13	Pivot, tip
L	1	CM718	0119-B103-2	Loop, tip

**ALL PIVOTS ARE
0.495 in W x 1.125 in H**
When ordering, measure
height and thickness. This
may vary. **CONSULT 3.00 net**
charge each for grinding to
size.

Consult Suggested list/76 lb shipping weight

Kit No. CM-770-K

Suspension Kit For CM-769-K TYPE A

REF #	QTY	RICE LAKE PN	EQUIV. CARDINAL #	DESCRIPTION
M	20	CM739L	0119-C014	Link
N	10	CM740	0119-B026	Saddle block
O	10	CM738	0119-B025, 47SRF	Trunnion

Consult Suggested list/243 lb shipping weight

Kit No. CM-771-K

Suspension Kit For CM-769-K TYPE B

REF #	QTY	RICE LAKE PN	EQUIV. CARDINAL #	DESCRIPTION
M	20	CM775L	46SRF	Link
N	10	CM741	44SRF	Saddle block
O	10	CM738	0119-B025, 47SRF	Trunnion

Consult Suggested list/234 lb shipping weight

* Measure load or fulcrum pivot height and width before ordering.

Truck Scale

Kit No. CM-756-K

Pivot and Bearing Kit For Models SR, SRice Lake, PR and PRice Lake, 5050SR, 5060SR, 5070SR, 6050SR, 6060SR, 6070SR

4-Section, 50- and 60-Ton, 50-, 60- and 70-Ft. Motor Truck Scale*

REF #	QTY	RICE LAKE PN	EQUIV. CARDINAL #	DESCRIPTION
A	8	CM702	1412-B001-3	Bearing, fulcrum
B	8	CM702	1412-B001-3	Bearing, load
C	16	CM704P	1400-B001-19	Pivot, load and fulcrum
D	4	CM703P	1400-B001-9	Pivot, tip
E	4	CM720	0119-B127-53	Bearing, lower shackle
F	8	CM721	0119-B127-53	Bolt, shackle
G	4	CM719	0119-B127-53	Bearing, upper shackle
H	4	CM712P	1400-B001-5	Pivot, load
I	4	CM703P	1400-B001-9	Pivot, fulcrum
J	4	CM701	1412-B001-9	Bearing, fulcrum
K	1	CM703P	1400-B001-9	Pivot, tip
L	1	CM756	0119-B103-1	Loop, tip

**ALL PIVOTS ARE
0.495 in W x 1.125 in H**
When ordering, measure height and thickness. This may vary. **CONSULT 3.00 net charge each for grinding to size.**

Consult Suggested list/77 lb shipping weight

Kit No. CM-759-K

Suspension Kit For CM-756-K

REF #	QTY	RICE LAKE PN	EQUIV. CARDINAL #	DESCRIPTION
M	16	CM715L	0119-B007(16SRF)	Link
N	8	CM716	0119-B018(14SRF)	Saddle block
O	8	CM717	0119-B019(17SRF)	Trunnion

Consult Suggested list/280 lb shipping weight

* Measure load or fulcrum pivot height and width before ordering.

Truck Scale

Kit No. CM-767-K

Pivot and Bearing Kit For Models 5080SR, 6080SR, SR, SRice Lake, PR and PRice Lake
5-Section, 50- and 60-Ton, 80-Ft. Motor Truck Scale

REF #	QTY	RICE LAKE PN	EQUIV. CARDINAL #	DESCRIPTION
A	10	CM702	1412-B001-3	Bearing, fulcrum
B	10	CM702	1412-B001-3	Bearing, load
C	20	CM704P	1400-B001-19	Pivot, load and fulcrum
D	5	CM703P	1400-B001-9	Pivot, tip main lever
E	5	CM720	0119-B127-53	Bearing, lower shackle
F	10	CM721	0119-B127-53	Bolt, shackle
G	5	CM719	0119-B127-53	Bearing, upper shackle
H	5	CM712P	1400-B001-5	Pivot, load
I	5	CM703P	1400-B001-9	Pivot, fulcrum
J	5	CM701	1412-B001-9	Bearing, fulcrum
K	1	CM703P	1400-B001-9	Pivot, tip
L	1	CM756	0119-B103-1	Loop, tip

ALL PIVOTS ARE
0.495 in W x 1.125 in H
When ordering, measure height and thickness. This may vary. CONSULT 3.00 net charge each for grinding to size.

Consult Suggested list/93 lb shipping weight

Kit No. CM-768-K

Suspension Kit For CM-767-K

REF #	QTY	RICE LAKE PN	EQUIV. CARDINAL #	DESCRIPTION
M	20	CM715L	0119-B007	Link
N	10	CM716	0119-B018	Saddle block
O	10	CM717	0119-B019	Trunnion

Consult Suggested list/337 lb shipping weight

* Measure load or fulcrum pivot height and width before ordering.

Truck Scale

CARDINAL®

Kit No. CM-757-K

Pivot and Bearing Kit For Models SR, SRice Lake, PR and PRice Lake, 8050SR, 8060SR, 8070SR, 4-Section, 80-Ton, 50-, 60- and 70- Ft. Motor Truck Scale*

REF #	QTY	RICE LAKE PN	EQUIV. CARDINAL #	DESCRIPTION
A	8	CM747	1412-B001-5	Bearing, fulcrum
B	8	CM747	1412-B001-5	Bearing, load
C	16	CM748P	1400-B001-21	Pivot, load and fulcrum
D	4	CM703P	1400-B001-9	Pivot, tip
E	4	CM720	0119-B127-52	Bearing, lower shackle
F	8	CM721	0119-B127-52	Bolt, shackle
G	4	CM719	0119-B127-52	Bearing, upper
H	4	CM712P	1400-B001-5	Pivot, load
I	4	CM703P	1400-B001-9	Pivot, fulcrum
J	4	CM701	1412-B001-9	Bearing, fulcrum
K	1	CM703P	1400-B001-9	Pivot, tip
L	1	CM756	0119-B103-1	Loop, tip

ALL PIVOTS ARE
0.495 in W x 1.125 in H
When ordering, measure
height and thickness. This
may vary. CONSULT 3.00 net
charge each for grinding to
size.

Consult Suggested list/86 lb shipping weight

Kit No. CM-758-K

Suspension Kit For CM-757-K

REF NO.	QTY	RICE LAKE PN	EQUIV. CARDINAL #	DESCRIPTION
M	16	CM784L	0119-C007	Link
N	8	CM749	0119-B022	Saddle block
O	8	CM717	0119-B019(17SRF)	Trunnion

Consult Suggested list/327 lb shipping weight

* Measure load or fulcrum pivot height and width before ordering.

Dormant Scale

Kit No. CM-765-K

Pivot and Bearing Kit For Models XD4638L TO XD9672L, XD, XTD and XDL, 6,500 lb Capacity Dormant Scale

QTY	RICE LAKE PN	DESCRIPTION
4.....	CM743P	Pivot, main lever fulcrum, 3/8 in x 3/4 in x 1 7/8 in
4.....	CM745P	Pivot, main lever load, 3/8 in x 3/4 in x 2 3/4 in
4.....	CM751.....	Bearing, main lever fulcrum, 1 1/4 in dia x 1 in
4.....	CM757.....	Bearing, main lever load, 15/16 in x 1 3/8 in x 2 1/2 in
2.....	CM744P	Pivot, main lever tip, 3/8 in x 3/4 in x 1 in
2.....	CM752.....	Bearing, main lever tip, 15/16 in x 15/16 in x 1 in
2.....	CM742P	Pivot, transverse lever fulcrum, 3/8 in x 3/4 in x 1 1/4 in
2.....	CM750.....	Bearing, transverse lever fulcrum, 1 in dia x 9/16 in
2.....	CM744P	Pivot, transverse lever load, 3/8 in x 3/4 in x 1 in
2.....	CM754.....	Bearing, transverse lever, 7/8 in x 7/8 in x 11/16 in
2.....	CM753.....	Bearing, transverse lever fulcrum, 3/4 in x 3/4 in x 3/4 in
1.....	CM746P	Pivot, transverse lever fulcrum, 0.360 Sq. x 3 in

Consult Suggested list/8 lb shipping weight

Kit No. CM-766-K

Pivot and Bearing Kit, 12,000 lb Capacity Dormant Scale, Models SCD and SCDL

QTY	RICE LAKE PN	DESCRIPTION
4.....	CM789P	Pivot, main lever fulcrum, 3/8 in x 3/4 in x 2 3/8 in
4.....	CM745P	Pivot, main lever load, 3/8 in x 3/4 in x 2 3/4 in
4.....	CM787.....	Bearing, main lever fulcrum, 2 in dia x 1/38 in
4.....	CM757.....	Bearing, main lever load, 15/16 in x 1 3/8 in x 2 1/2 in
2.....	CM744P	Pivot, main lever tip, 3/8 in x 3/4 in x 1 in
2.....	CM752.....	Bearing, main lever tip, 15/16 in x 15/16 in x 1 in
2.....	CM742P	Pivot, transverse lever fulcrum, 3/8 in x 3/4 in x 1 1/4 in
2.....	CM750.....	Bearing, transverse lever fulcrum, 1 in dia x 9/16 in
2.....	CM744P	Pivot, transverse lever load, 3/8 in x 3/4 in x 1 in
2.....	CM754.....	Bearing, transverse lever fulcrum, 7/8 in x 7/8 in x 11/16 in
2.....	CM753.....	Bearing, transverse lever fulcrum, 3/4 in x 3/4 in x 3/4 in
1.....	CM746P	Pivot, transverse lever fulcrum, 0.360 Sq x 3 in

Consult Suggested list/11 lb shipping weight

* Measure load or fulcrum pivot height and width before ordering.

