

VS-37

*In-floor Veterinary Scale
Software Version 11525*

Operation Manual



© Rice Lake Weighing Systems. All rights reserved.

Rice Lake Weighing Systems® is a registered trademark of
Rice Lake Weighing Systems.

All other brand or product names within this publication are trademarks or
registered trademarks of their respective companies.

All information contained within this publication is, to the best of our knowledge, complete and
accurate at the time of publication. Rice Lake Weighing Systems reserves the right to make
changes to the technology, features, specifications and design of the equipment without notice.

The most current version of this publication, software, firmware and all other product
updates can be found on our website:

www.ricelake.com

Revision History

This section tracks and describes the current and previous manual revisions for awareness of major updates and when the updates took place.

Revision	Date	Description
A	November 25, 2024	Established a revision history; software version 11525

Table i. Revision Letter History



Technical training seminars are available through Rice Lake Weighing Systems. Course descriptions and dates can be viewed at www.ricelake.com/training or obtained by calling 715-234-9171 and asking for the training department.

Contents

1.0 Introduction	5
1.1 FCC Compliance	5
1.2 Disposal	5
1.3 Safety	6
2.0 Installation	7
2.1 Scale	7
2.2 Site Preparation	7
2.3 Unpacking	7
2.4 Assembly	8
2.5 Electrical Interface to the Indicator	8
2.6 Insert Batteries	9
2.6.1 Power Connection	9
2.7 Load Cell Connections	10
2.8 Pit Installation	11
2.9 Dimensions	11
3.0 Operation	12
3.1 Key Descriptions	12
3.2 Weighing	13
3.3 Hold/Release Function	13
3.4 Preset Tare	13
3.5 Toggle Tare	13
3.6 Using the Body Mass Index (BMI) Function	14
3.6.1 LB Mode	14
3.6.2 KG Mode	14
3.7 Troubleshooting	15
4.0 Communications	16
4.1 Push-button Keypad Print	16
4.2 USB Connection	17
5.0 Maintenance	18
5.1 Basic Maintenance	18
5.2 Cleaning	18
6.0 Specifications	19



Rice Lake continually offers web-based video training on a growing selection of product-related topics at no cost. Visit www.ricelake.com/webinars

1.0 Introduction

The VS-37 in-floor veterinary scale is a heavy-duty scale that offers exceptional performance measuring 36 in x 36 in (0.91 m x 0.91 m) and has a capacity of up to 1000 lb (500 kg). The VS-37 in-floor veterinary scale is designed to be mounted in a pit flush with the floor.



Manuals are available from Rice Lake Weighing Systems at www.ricelake.com/manuals

Warranty information is available at www.ricelake.com/warranties

1.1 FCC Compliance

United States

This equipment has been tested and found to comply with the limits for a Class A digital device, pursuant to Part 15 of the FCC Rules. These limits are designed to provide reasonable protection against harmful interference when the equipment is operated in a commercial environment. This equipment generates, uses, and can radiate radio frequency energy and, if not installed and used in accordance with the instruction manual, may cause harmful interference to radio communications. Operation of this equipment in a residential area is likely to cause harmful interference in which case the user will be required to correct the interference at his own expense.

Canada

This digital apparatus does not exceed the Class A limits for radio noise emissions from digital apparatus set out in the Radio Interference Regulations of the Canadian Department of Communications.

Le présent appareil numérique n'émet pas de bruits radioélectriques dépassant les limites applicables aux appareils numériques de la Class A prescrites dans le Règlement sur le brouillage radioélectrique édicté par le ministère des Communications du Canada.

1.2 Disposal



Product Disposal

The product must be brought to appropriate separate waste collection centers at the end of its life cycle.

Proper separate collection to recycle the product helps prevent possible negative effects on the environment and to health, and promotes the recycling of the materials. Users who dispose of the product illegally shall face administrative sanctions as provided by law.

Battery Disposal

Dispose of batteries at appropriate waste collection centers at the end of their life cycle in accordance with local laws and regulations. Batteries and rechargeable batteries may contain harmful substances that should not be disposed of in household waste. Batteries may contain harmful substances including but not limited to: cadmium (Cd), lithium (Li), mercury (Hg) or lead (Pb). Users who dispose of batteries illegally shall face administrative sanctions as provided by law.



WARNING: Risk of fire and explosion. Do not burn, crush, disassemble or short-circuit lithium batteries.

1.3 Safety

Safety Definitions:



DANGER: Indicates an imminently hazardous situation that, if not avoided, will result in death or serious injury. Includes hazards that are exposed when guards are removed.



WARNING: Indicates a potentially hazardous situation that, if not avoided, could result in serious injury or death. Includes hazards that are exposed when guards are removed.



CAUTION: Indicates a potentially hazardous situation that, if not avoided, could result in minor or moderate injury.



IMPORTANT: Indicates information about procedures that, if not observed, could result in damage to equipment or corruption to and loss of data.

General Safety



Do not operate or work on this equipment unless this manual has been read and all instructions are understood. Failure to follow the instructions or heed the warnings could result in injury or death. Contact any Rice Lake Weighing Systems dealer for replacement manuals.



WARNING: Failure to heed could result in serious injury or death.

Ensure every individual who operates or works with this unit has read and understands all safety information.

Do not transport the scale while someone is on the scale.

Do not allow minors (children) or inexperienced persons to operate this scale.

Do not use in the presence of flammable materials.

Do not use this product if any of the components are loose or cracked.

Do not use near water.

Do not use the scale on slippery surfaces, such as a wet floor.

Do not place fingers into slots or possible pinch points.

To avoid cross contamination, the scale should be cleaned regularly.

Prior to cleaning, make sure the scale is disconnected from the power source.



IMPORTANT: Do not drop the scale or subject it to violent shocks.

Do not jump on the scale.

For accurate weighing, the scale must be placed on a flat, stable surface.

Operating at voltages and frequencies other than specified could damage the equipment.

Avoid contact with excessive moisture.

Do not make alterations or modifications to the scale.

Rice Lake Weighing Systems offers optional AC adapters; utilizing an adapter not supplied by Rice Lake Weighing Systems voids all warranties and approvals.

Weight exceeding the maximum capacity may damage the scale.

2.0 Installation

The following section provides installation instructions for the VS-37 in-floor veterinary scale.

2.1 Scale

Standard installation of the scale consists of the following:

- Site preparation
- Unpacking the scale
- Assembly
- Electrical interface to the indicator
- Pit installation
- Load cell connections
- Powering the scale

2.2 Site Preparation

Consider the following when choosing a site for the scale:

- Select a site where overweight loads can maneuver easily without crossing the platform
- Avoid areas where damage could occur from side impacts of wheels or forklift tines
- Avoid areas where falling objects could cause shock damage
- Avoid areas where water may damage a scale not meant for a washdown environment
- The scale must be level within 1/4 inch of horizontal
- The interface cable between the scale and the indicator must be protected from crushing, cutting and moisture damage



IMPORTANT: *The scale must not be loaded beyond capacity, even momentarily.*

Choose a site where the floor is level to 1/4 inch to avoid excessive shimming. The floor may require modification if unable to select an area up to this standard.

If the chosen site has potential dangers to cable integrity, cable protection is required, such as running the cable in conduit.

2.3 Unpacking

Remove all packing material and inspect the contents for damage possibly caused during shipment. Contact Rice Lake Weighing Systems and the shipper immediately if there is damage to the scale. The shipping container should contain the scale, pit frame, scale feet, this manual, the indicator, and a 10 ft length of load cell cable.

The VS-37 in-floor veterinary scale has one threaded hole located in the center of the deck to allow for the installation of an eyebolt. An eyebolt hook and chains can be used to lift the scale. It is recommended to use a 1/2 inch-20NF eyebolt for lifting the scale.

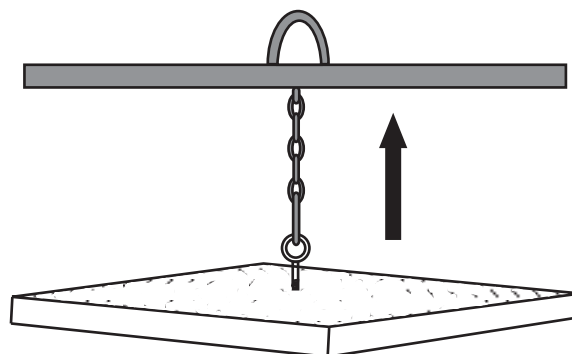

Figure 2-1. Proper Lifting Technique

2.4 Assembly

The scale feet are shipped attached to the scale.

1. Ensure each foot is screwed in until the foot touches either the load cell or the underside of the deck.
2. Unscrew each foot three complete turns and level the scale so all of the feet are in contact with the floor.
3. Adjust corners not contacting the floor by unscrewing the feet until the feet contact the floor surface.
4. When all of the feet are contacting the floor, check the deck with the spirit level to ensure the scale is within 1/4 inch of level.

2.5 Electrical Interface to the Indicator

10' of 4-wire cable for connecting the scale to the weight indicator is supplied with each scale. The junction box is accessible through an access plate located on the side of the scale. Use the following steps to wire the junction box:

1. Remove the two #10 x 3/8 inch screws.
2. Slide the junction box assembly out of the deck.
3. Open and remove the top of junction box.
4. Push the cable end into the junction box through a cord grip.
5. Connect the wires to the indicator terminal (Figure 2-2) as shown in Table 2-1.
6. Pull out excess and tighten the cord grip to hold the cable snugly.

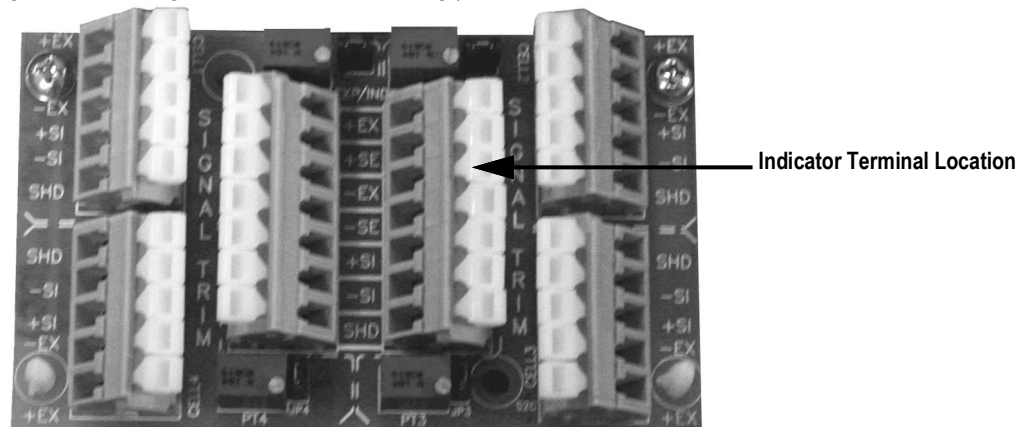

Figure 2-2. Junction Box Wiring

Cable Color Code	Junction Box
White	+EX
Green	-EX
Black	+SIG
Red	-SIG

Table 2-1. Titanium 10-Button Indicator Junction Box Connections

7. The cable must be routed to the indicator in a manner that will protect the cable from damage. The method of cable protection in non-washdown applications is shown in Figure 2-3. Leave a loose coil of excess cable under the scale to facilitate lifting of the scale for servicing and cleaning.

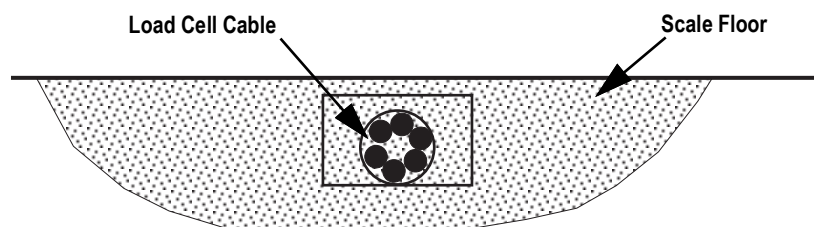

Figure 2-3. Cable Protection

8. Complete the connections to the indicator once the cable is protected and in its final position.
9. Ensure all strain relief fittings are tight.
10. Replace the junction box cover and slide the junction box back into the scale deck.
11. Replace the access plate and secure with the screw removed in [Step 1 on page 8](#).

2.6 Insert Batteries

The six AA batteries supplied with the scale provide an average of 25 hours of continuous use.

To install the batteries:

1. Turn thumbscrew counterclockwise then remove battery cover.
2. Insert batteries into the battery chamber as illustrated.

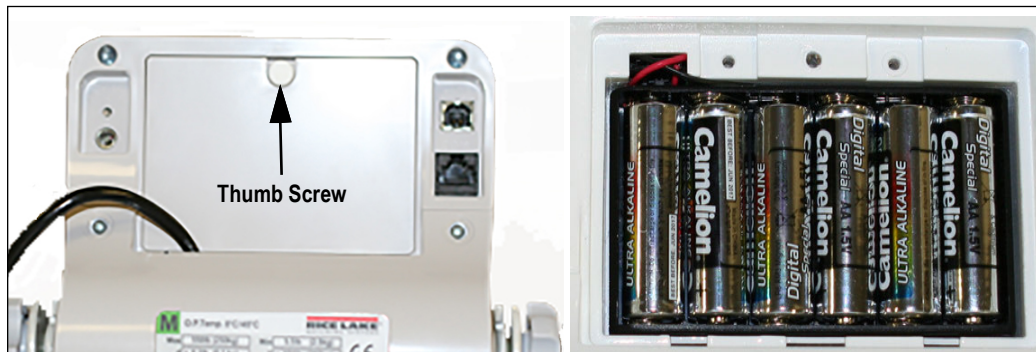

Figure 2-4. Battery Chamber

3. Put the cover in place and turn the thumbscrew clockwise to secure.



NOTE: Remove the batteries prior to storing if the product is not going to be used for an extended period of time.



NOTE: If the LO BAT indicator activates, for accurate weighing, replace the batteries or connect the scale to an AC power source as soon as possible.

2.6.1 Power Connection

An optional AC power adapter can be used when a power outlet is available.



IMPORTANT: Only use power adapters supplied by or purchased from Rice Lake Weighing Systems. The use of a power adapter not from Rice Lake Weighing Systems voids the warranty.

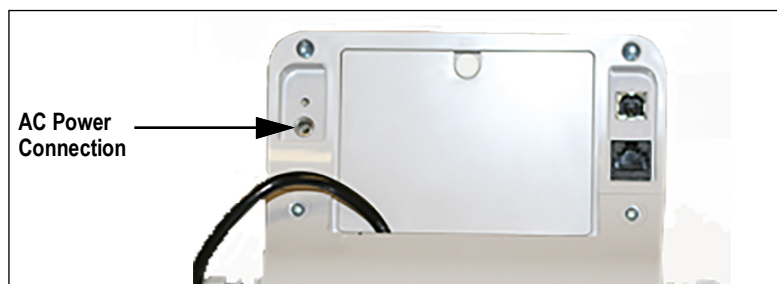

Figure 2-5. Power Connection Site



NOTE: The battery annunciator on the display turns off when using an AC power connection. The brightness of the backlight is reduced to 60% when using battery power.

2.7 Load Cell Connections

The indicator and scale comes factory installed with a load cell cable connection. Follow the procedure below if the load cell cable needs to be replaced or reconnected to the indicator.

1. Unscrew and remove the tilt stand bracket from the indicator to gain access to the load cell connection.

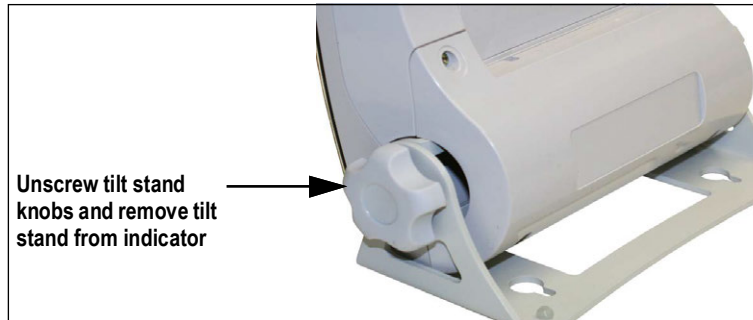

Figure 2-6. Remove Tilt Stand

2. Remove the four back retaining screws to remove the back cover to the indicator.

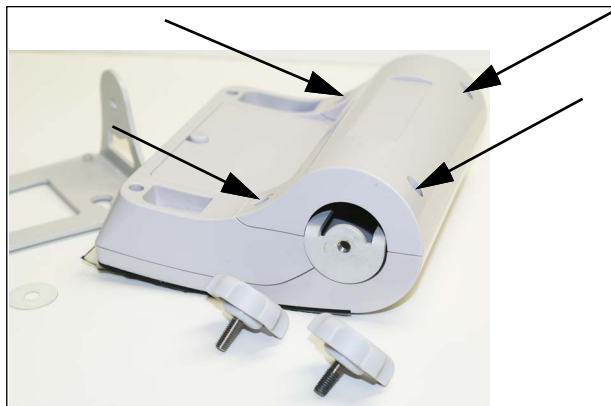

Figure 2-7. Remove Back Cover

3. Plug the end of the load cell cable into the load cell connection. When it clicks the load cell cable is properly seated into the connection.



Figure 2-8. Load Cell Connection Point

4. Reinstall the back cover and attach to the tilt stand.

2.8 Pit Installation

The scale can be installed in a pit using the pit frame. Optional height-adjustment holes are available. The following site considerations and pit frame drawings are meant as a brief overview of the principles involved in mounting a scale in a floor-level pit and are for reference only (the pit must be installed in poured-concrete foundation according to standard construction practices).

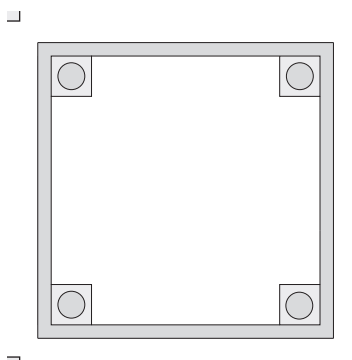

Figure 2-9. Pit Frame Diagram

A 1:24 slope is recommended for the pit with full grouting under the corner pads.

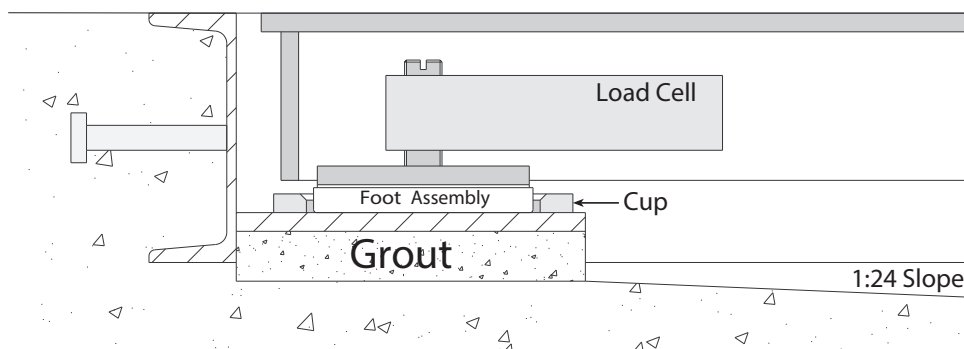

Figure 2-10. Installed VS-37 and Pit Frame Section

2.9 Dimensions

Dimensions for the VS-37 are provided in [Figure 2-11](#).

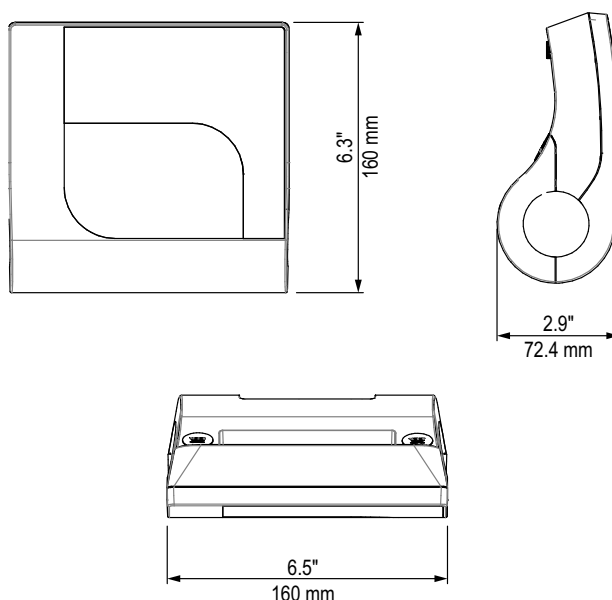

Figure 2-11. Indicator Dimensions

3.0 Operation

This section describes the front panel and includes procedures for operation of the scale.



Figure 3-1. Front Panel Keypad

3.1 Key Descriptions

The display has 10 front panel keys. Key functions are described in the table below.



IMPORTANT: The front panel keys are very sensitive, so only a gentle press is required.













Key	Name	Function
 On/Off	On/Off	Powers the scale on or off
 Print LB/KG	Print LB/KG	Sends data out from the RS-232 port; Allows to toggle between kilograms and pounds providing that it is enabled in Configuration mode; Cannot toggle while in the BMI mode
 Zero	Zero	Only functions if the current weight is stable and less than 2% of the capacity of the scale. Anything over 2% requires a recalibration
 Hold Release	Hold Release	Displays most current weight value on the display and holds that value when the animal is off the scale. A second press releases the weight value. Not active while in BMI mode
	BMI	Pressing the BMI key enables access to the BMI (Body Mass Index) mode (defaults when scale is turned on). The animal is gets on the scale, weight stabilizes and press the BMI key. The display then asks for the animal height to calculate out the animal BMI.
	TARE	Used to remove the weight initially of anything on the scale that shouldn't be included in the total weight of the animal on the scale
	CLEAR	When using the BMI function, the display looks for a height entry. Pressing Clear changes this entry back to 190.0 cm (default) or 5 ft, 7.5 in. Once BMI is displayed, pressing the Clear key exits BMI
	ENTER	Used to accept height in BMI mode; accepts the value of the parameter last entered and moves to the next stage. Pressing and holding Enter during startup will display ID. This is the first setup on entering into configuration mode
	Up Arrows	Adjusts the value of the flashing digit/number Adjusts height input (0.5 in/0.5 cm) while in BMI mode
	Down Arrows	Adjusts the value of the flashing digit/number Adjusts height input (0.5 in/0.5 cm) while in BMI mode

Table 3-1. Key Functions



3.2 Weighing

Use the following steps to weigh.

1. Press  to turn on the scale. **0.0** appears on the display along with the **ZERO** annunciator.
2. Place the animal on the scale. The animal's weight is displayed, the **LOCK** annunciator is on and the indicator beeps to indicate the end of the weighing process.
3. Press  to change the display from lb to kg and vice-versa.
4. Press and hold  until **OFF** displays to turn off the scale.

3.3 Hold/Release Function

Use the following steps to use the Hold/Release function.

1. Press  to turn on the scale. **0.0** prompts along with **ZERO** on the display.
2. Press  once the animal's weight stabilizes. The animal's weight and the **HOLD** and **LOCK** annunciators remain on the display when the animal is off the scale.
3. Press  again to return the scale to zero.





NOTE: Pressing  will not work while using Hold/Release function.



NOTE: Pressing  prior to the animal getting on the scale will also hold the weight display.

3.4 Preset Tare

Use the following steps for the Preset Tare function prior to animal weighing if additional items are being used by the animal.

1. Press  to turn on the scale. **0.0** appears on the display along with the **ZERO** annunciator.
2. Place additional item(s) on the scale.
3. Press  until the display returns to **0.0** and **NET** annunciator appears on the display.
4. Remove additional item(s) from the scale. The weight displays with a negative symbol to the left of it.



NOTE: Not removing the additional item(s) prior to animal weighing will also work.





5. Position the animal and additional item(s) on the scale. The display identifies the animal weight. The **NET** annunciator is still active. The weight of the additional item(s) remains stored in memory for the duration of this weigh in.
6. To cancel the tare weight, remove animal from the scale and press  until **NET** disappears from the display and the display turns back to **0.0** and **GROSS** appears.



NOTE: Tare weight is also canceled when the scale is turned off.

3.5 Toggle Tare





Use the following steps to use the Toggle Tare function when the additional item to be weighed is known.

1. Press  when the scale is empty and **0.0** displays. The default values prompts while **0.0** is flashing on the display (default is programmed to be 33.0 lb/15.0 kg).
2. Use  and  to adjust the value. Press  to start the tare function. The **NET** annunciator turns on instead of the **GROSS** annunciator.





3.6 Using the Body Mass Index (BMI) Function

Use the following steps in determining the BMI.

3.6.1 LB Mode

1. Ensure that the scale is at zero.
2. Place the animal on the scale to obtain a weight. The **LOCK** annunciator appears on the display.
3. Press . The **BMI** and **FT/IN** annunciators appear on the display and a default height value of 5 feet - 7.5 inch (5 - 07.5) is flashing.
4. Use  and  to adjust the height value.
5. Press .
6. The BMI value and **BMI** annunciator are shown on the display. Press  to return to the **Weighing** mode and the BMI function will be turned off.

3.6.2 KG Mode

1. Ensure that the scale is at zero.
2. Place the animal on the scale to obtain a weight. The **LOCK** annunciator appears on the display.
3. Press . The **BMI** and **CM** annunciators appear on the display and a default height value of 170.0 cm (170.0) is flashing.
4. Use  and  to adjust the height value.
5. Press .
6. The BMI value and **BMI** annunciator are shown on the display. Press  to return to the **Weighing** mode and the BMI function will be turned off.

3.7 Troubleshooting

Refer to the following table to check and correct any failure before contacting service personnel.

Symptom	Possible Cause	Corrective Action
Scale does not turn on	Dead batteries	Replace batteries or connect to AC power
	Faulty electrical outlet	Use a different electrical outlet
	Bad power supply	Replace adapter
Questionable weight or the scale does not zero	External object is interfering with the scale	Remove the interfering object from the scale
	Display did not show 0.0 before weighing	Help the animal off the scale, zero the scale and begin the weighing process again
	Scale is not placed on a level floor	Ensure scale is level and begin the weighing process again
	Scale is out of calibration	Check the weight with a certified calibration weight
	Scale base is touching floor during a weighment	Adjust height of feet so fingers can slide between the base of scale and the floor all the way around the platform
The display shows a STOP message	The load on the scale exceeds the capacity of the scale	Remove the excess weight and use the scale according to manufacture specifications
The display shows LO Bat message	The battery is low	Replace batteries
The display shows E and Err messages as detailed below		
E06	Identifier - ADC	AD too high
E07		AD too low
E10	Overload	Scale has been overloaded. Remove load from scale
E4L	BAT	Battery low, but still usable- one bar left on indicator display
E4U		Battery low and unstable - no bars left on indicator display
E11	CAL	Calibration Error - recalibrate scale
Err 1	Load cell cable may be plugged into wrong connection port	Ensure cable is connected to the load cell connection port. Note: Load cell connection point is located underneath the curved plastic cover of the indicator. Remove four back retaining screws, remove curved back cover to access load cell connection point.
Err 2	Low saturation state (low A/D)	The load cell is not connected properly; Check the cables and mechanical connections; if the problem persists, replace the set of load cells
Err 3	High saturation state (high A/D)	See Err 2
Err 6	Unstable weight; Cannot calibrate	Check the load cell mechanical surroundings and ensure nothing is contacting the load cell and that the cables are properly welded
Err 7	Scale isn't moving	Make sure feet are installed on the scale. Turn the feet all the way in and then back them out three full turns, then level the scale
SAT	Damaged load cell cable	Replace load cell cable
	Load cell cable may be plugged into wrong connection port	Ensure cable is connected to the load cell connection port. Note: Load cell connection point is located underneath the curved plastic cover of the indicator. Remove four back retaining screws, remove curved back cover to access load cell connection point.

Table 3-2. Troubleshooting Table

4.0 Communications

The unit comes with an RS-232 port that enables weight data to be transmitted to other equipment, such as a computer or printer. The RS-232 cable with DB-9 connector (PN 100719) is available from Rice Lake Weighing Systems. That connection is shown in USB Connection section on the next page.

The RS-232 parameters are:

- 9600 baud (selectable in the programming mode)
- 8 data bits
- 1 stop bit
- no parity
- no handshaking

There are three methods of communication:

- Push-button keypad print
- Standard remote protocol
- Escape protocol

4.1 Push-button Keypad Print

With a stable, in-range weight, press and hold  for at least three seconds, or until the scale emits two quick beeps.



NOTE: If the scale does not beep after five seconds, release  as the weight was either in motion or out of range.

If displaying weight and not BMI, the scale will send out the following 21 character string:

```
xxxxxxxx<SP>uu<SP>mmmm<SP><CR><LF>
```

Token	Description
xxxxxxxx	Weight with decimal point and “-” sign
<SP>	Space
uu	Unit - lb or kg
mmmm	Mode - gross or net
<CR>	Carriage return
<LF>	Line feed (moves cursor down to the next line)

Table 4-1. Print Format Tokens

Example:

```
-10 Lb net = <SP><SP><SP><SP>-10.0<SP>lb<SP><SP>Net<SP><SP><SP><CR><LF>
```

```
10 Lb gross = <SP><SP><SP><SP><SP>10.0<SP>lb<SP>Gross<SP><CR><LF>
```

- The scale will send out the following data while in **BMI** mode (displaying the BMI value):

Setting	Value
Gross Weight	215 Lb
Tare Weight	0.0 Lb
Net Weight	215 Lb
Animal Height	6-01.0 ft
Animal BMI	28.4

Table 4-2. BMI Data

4.2 USB Connection

The scale has the capability of connecting to a Windows® computer (PC) using a USB cable (not included) and a terminal emulation program. A terminal emulation program allows the transfer of data between the scale and PC using a serial port.



Figure 4-1. Connection Ports

NOTE: Apple® and Macintosh® computers are unable to transfer the necessary data to the scale. Only use a PC for data transfer.

Connecting software and downloads should always be addressed by the IT department for safety reasons and can vary depending on what type of computer platform is being used.

NOTE: Consult the IT department if driver protections are preventing the use of the USB driver. Driver protections may need to be temporarily disabled on Windows 10 or later computers to allow for the installation of the USB driver.

1. Connect the scale's indicator to a PC using a USB-Type B to USB-Type A cable (not included).
2. Turn the indicator on.

NOTE: In most cases, the PC should find the driver and automatically configure the driver when the scale is plugged into a USB port.

3. Open a terminal emulation program, such as Advanced Serial Port Terminal, pUttY or Hercules (used in this example).
4. Connect to the serial port assigned by the PC (COM5 in example). This can be found in Device Manager. Once selected, press **Open**.

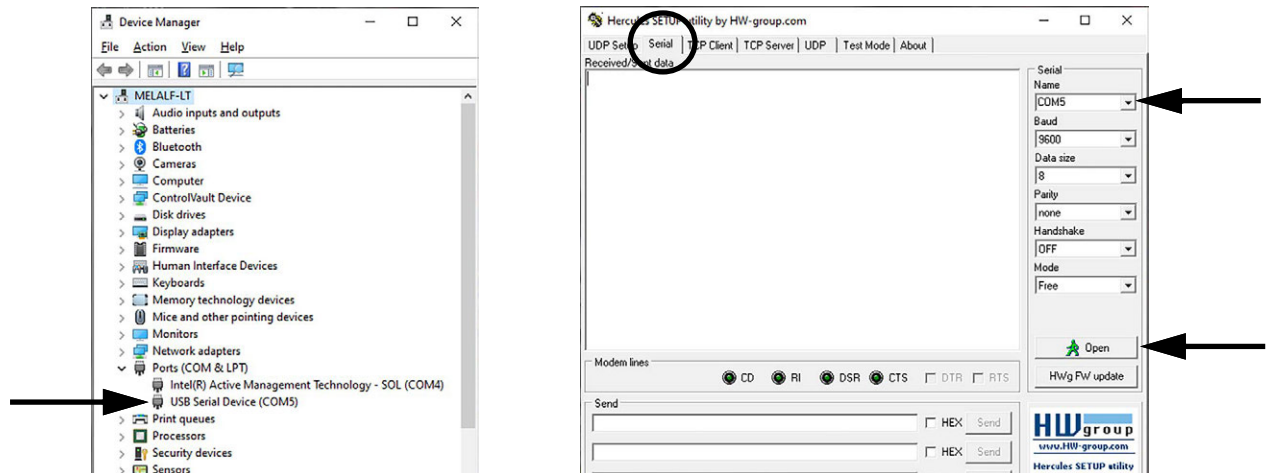

Figure 4-2. Connecting to a Serial Port

5. With weight on the scale, press and hold the **Print** button on the indicator for three seconds. The animal's weight is sent to the PC.

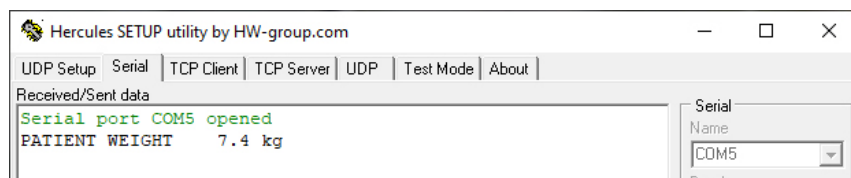

Figure 4-3. Animal Weight Displayed

5.0 Maintenance

The following section provides instructions for maintaining and cleaning the unit.

5.1 Basic Maintenance

Before the first use of the scale and after periods of non-use, check the scale for proper operation and function. If the scale does not operate correctly, contact a qualified service personnel.

Go through the following steps for basic maintenance.

- Check the overall appearance of the entire scale for any obvious signs of damage
- Inspect the condition of the AC power adapter cord for cracking, fraying or for broken or bent prongs

5.2 Cleaning

Proper care and cleaning is essential to ensure a long life of accurate and effective operation. Before beginning the cleaning process, disconnect the scale from the AC power source.

- Clean all external surfaces with a clean, damp cloth or tissue. Mild soap and water solution may be used. Dry with a clean soft cloth
- Do not immerse the scale into cleaning or other liquid solutions
- Do not use isopropyl alcohol or other solutions to clean the display surface

6.0 Specifications

Electrical Grounding

For systems where the scale is connected to a 115 VAC circuit, the indicator must be directly connected to an earth ground with a ground interface cable of no more than 3 W resistance throughout its length.

Power

120 VAC-9 VDC-50 Hz / 230 VAC-9 VDC-50 Hz

Battery Type

AA Alkaline

Battery Use

25 hours of continuous use

Automatic power-off can be configured

Environmental

Operating Temperature 50°F to 104°F (14°C to 40°C)

Storage Temperature 32°F to 158°F (0°C to 70°C)

Humidity 85% relative humidity

Dimensions

(H x L) 36 in x 30 in Handrail and mounting hardware

(W x L) 36 in x 36 in Mild steel painted pit frame

Safe Static Overloading Capacity

Maximum 150% of scale capacity

Load Cell Excitation

Rated Excitation 10 VDC

Maximum Excitation 15 VDC

Grade Level Requirements

The supporting surface for the four feet of the scale must be level within 1/4" of horizontal.



© Rice Lake Weighing Systems Content subject to change without notice.

230 W. Coleman St. • Rice Lake, WI 54868 • USA USA: 800-472-6703 • International: +1-715-234-9171