

# Healthweigh® H251-10-4

---

*Class I MDR Multifunction Handrail Scale*

## Operation Manual



© Rice Lake Weighing Systems. All rights reserved.

Rice Lake Weighing Systems® is a registered trademark of  
Rice Lake Weighing Systems.

All other brand or product names within this publication are trademarks or  
registered trademarks of their respective companies.

All information contained within this publication is, to the best of our knowledge, complete and  
accurate at the time of publication. Rice Lake Weighing Systems reserves the right to make  
changes to the technology, features, specifications and design of the equipment without notice.

The most current version of this publication, software, firmware and all other product  
updates can be found on our website:

[www.ricelake.com](http://www.ricelake.com)

# Revision History

---

This section tracks and describes manual revisions for awareness of major updates.

Revision	Date	Description
A	October 3, 2023	Established revision history
B	August 13, 2024	Updated compliance and certification sections

*Table i. Revision Letter History*



*Technical training seminars are available through Rice Lake Weighing Systems. Course descriptions and dates can be viewed at [www.ricelake.com/training](http://www.ricelake.com/training) or obtained by calling 715-234-9171 and asking for the training department.*

# Contents

---

<b>1.0 Introduction</b>	<b>5</b>
<b>2.0 Setup</b>	<b>7</b>
2.1 Unpacking the Scale	7
2.2 Assembling the Scale	7
2.3 Transporting the Scale	9
2.4 Setting the Device	9
2.5 Using the Scale	9
<b>3.0 Operation</b>	<b>10</b>
3.1 Keypad	10
3.2 Display	11
3.3 Scale Operation	12
3.4 Weighing	12
3.5 BMI Procedure	12
3.6 Rechargeable Battery	13
3.7 Power and Communication Connections	14
3.8 Communication	14
3.9 Print Button	15
<b>4.0 Maintenance</b>	<b>16</b>
4.1 Cleaning	16
4.2 Replacing Batteries	16
4.3 Calibration Procedure	16
4.4 Troubleshooting	17
<b>5.0 Specifications</b>	<b>19</b>
<b>6.0 Appendix</b>	<b>20</b>



Rice Lake continually offers web-based video training on a growing selection of product-related topics at no cost. Visit [www.ricelake.com/webinars](http://www.ricelake.com/webinars)

# 1.0 Introduction

The Healthweigh® Handrail Scale is an electronic device designed to measure the weight of a wheelchair occupant who is unable to vacate their wheelchair. It may also function as a patient stand-on scale. It is designed as a floor-standing or floor integrated platform whereby the known weight of the wheelchair is subtracted from the total measured weight, providing the weight of the wheelchair occupant. It is not designed to weight a bed/stretcher.

The scale is used to establish weight and height, as well as BMI (Body Mass Index). Communication is through serial and/or USB cable. The transmission is sent to a printer or PC with a click of a button. A simple and easy protocol allows a trouble-free interface to an EMR data base system.



Manuals are available from Rice Lake Weighing Systems at [www.ricelake.com/manuals](http://www.ricelake.com/manuals)

Warranty information is available at [www.ricelake.com/warranties](http://www.ricelake.com/warranties)

## Safety Definitions:



**DANGER:** Indicates an imminently hazardous situation that, if not avoided, will result in death or serious injury. Includes hazards that are exposed when guards are removed.



**WARNING:** Indicates a potentially hazardous situation that, if not avoided, could result in serious injury or death. Includes hazards that are exposed when guards are removed.



**CAUTION:** Indicates a potentially hazardous situation that, if not avoided, could result in minor or moderate injury.



**IMPORTANT:** Indicates information about procedures that, if not observed, could result in damage to equipment or corruption to and loss of data.

## General Safety



**Do not operate or work on this equipment unless this manual has been read and all instructions are understood. Failure to follow the instructions or heed the warnings could result in injury or death. Contact any Rice Lake Weighing Systems dealer for replacement manuals.**



**WARNING:** Failure to heed could result in serious injury or death.

**Do not use in the presence of flammable materials.**

**Operating at other voltages and frequencies than specified could damage the equipment. Use only medical approved mains adapters compliant with EN60601-1 standard.**

**Do not modify this equipment without authorization of the manufacturer.**

**Do not put this equipment next to or stacked on top of other equipment. This may result in malfunction. If such placement is unavoidable, ensure equipment is monitored regularly for correct operation.**

**Do not use accessories, transducers or cables other than those specified or provided by manufacturer. This could result in increased electromagnetic emissions or decreased electromagnetic immunity leading resulting in malfunction (see [Section 6.0 on page 20](#)).**

**Portable RF communications accessories (including peripherals such as antenna cables and external antennas) should be used no closer than 30 mm to the equipment or cables specified by the manufacturer. This may result in equipment performance degradation (see [Section 6.0 on page 20](#)).**

**Ensure the equipment is located in a shielded location. Failure to do so may result in performance degradation, interference with other equipment or interference with radio services.**

**This equipment has been tested for radiated RF immunity at selected frequencies. Using this equipment near equipment emitting other frequencies could result in improper operation (see [Section 6.0 on page 20](#)).**



**CAUTION:** To prevent injury, never leave the person being weighed unattended while on the scale.

To prevent injury, do not transport the scale while a patient is on the scale.

Make sure no load is on the scale before transporting the scale.

Do not drop the scale or subject it to violent shocks.

The scales are for determining weight of persons in rooms intended for carrying out medical care. The scales are NOT intended to diagnose, prevent and monitor diseases. The scales are equipped with serial interface that can connect to the equipment compliant with EN60601-1 standard.

Do not use scale for dynamic weighing.

Do not leave a permanent load on the weighing plate. This can damage the scale.

Be careful to avoid shock and overloading the scale in excess of the prescribed maximum load rating (MAX.) minus any tare weight that is already present.

Never operate the scale in a hazardous location. The scale design is not explosion-proof. Attention should be paid that flammable mixture may also be formed from anesthetic means that contain oxygen or nitrous oxide (laughing gas).



**IMPORTANT:** For accurate weighing, the scale must be placed on a flat, stable surface.

For accurate weighing, verify proper operation according to the procedure described in this manual before each use.

If the "LO Bat" indicator activates, for accurate weighing, recharge the battery or connect the scale to an AC power source as soon as possible.

To avoid cross contamination, clean the scale plate after each weighing. Avoid direct skin contact during weighing.

Materials in the products have been tested and approved for the safe use by operator and patient.

The scale purpose is to determine weight in course of medical practice.

Used as non-automatic scale a person is to be positioned in the center of the scale plate. The weighing value can be read off after a stable weighing value has been obtained.

All batteries included with Healthweigh products intended for sale in the EU market are classified as 'Portable Batteries for General Use' and comply with European Battery Regulation (EU) 2023/1542.

## 1.1 Disposal



### Product Disposal

The product must be brought to appropriate separate waste collection centers at the end of its life cycle.

Proper separate collection to recycle the product helps prevent possible negative effects on the environment and to health, and promotes the recycling of the materials. Users who dispose of the product illegally shall face administrative sanctions as provided by law.

### Battery Disposal

Dispose of batteries at appropriate waste collection centers at the end of their life cycle in accordance with local laws and regulations. Batteries and rechargeable batteries may contain harmful substances that should not be disposed of in household waste. Batteries may contain harmful substances including but not limited to: cadmium (Cd), lithium (Li), mercury (Hg) or lead (Pb). Users who dispose of batteries illegally shall face administrative sanctions as provided by law.



**WARNING:** Risk of fire and explosion. Do not burn, crush, disassemble or short-circuit lithium batteries.

## 2.0 Setup

Scales must be verified to monitor weight of patients.

### 2.1 Unpacking the Scale

Visually inspect the scale to ensure all components are included in the box. The box should contain the scale, the indicator, this manual, and a box labeled *Parts Inside*.

Parts Inside box should include the following parts:

- Set of hardware kit for hand rail fixation
- Four feet for the scale
- 5 mm Hex key (Allen key)
- Power adapter 230/120/ ACV 50/60 Hz - 9 VDC 0.5 AMP
- RS232 communication cable 2.0 meter

Remove the scale units from the box and arrange them on a clear work area.

- Scale platform
- handrails
- Hardware kit for attaching the handrails



**CAUTION: Do not drop the scale. Dropping the scale might damage the scale and cause personal injury**

Tools Required for Assembly:

5 mm Hex key (Allen key) supplied

### 2.2 Assembling the Scale

Use the following procedure to assemble the scale:

1. Lower the base platform down to the floor.



**CAUTION: The platform is heavy. Take care not to drop it. Dropping the platform might damage the measuring results.**

2. Unfold the rail into vertical position.
3. Use the hexagon key to tighten the screws into the hinges.

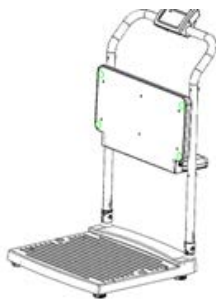

Figure 2-1. Unfolded Scale

4. Tilt back the scale and assemble the feet of the scale.

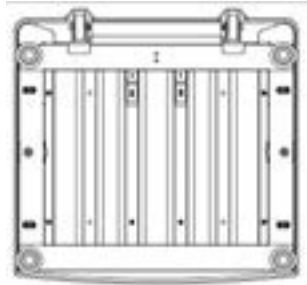

Figure 2-2. Underside of the Scale

5. Attach the side rails by placing each side rail into the hole on the main handrail and in the hole on the base (total 4 holes)



**IMPORTANT:** *Up side is marked on all of handrail adapters.*



Figure 2-3. Side Handrails Assembled

6. Fix all four points with the Allen screw
7. Tighten the Allen screw heads to ensure that the scale is firmly secured and stable.



## 2.3 Transporting the Scale



**CAUTION:** Ensure there is no load on the scale.

While folding the chair, fingers might be caught and pinched and cause personal injury.



**IMPORTANT:** Do not drop the scale while repositioning. Dropping the scale might damage the scale or cause personal injury.

The scales are equipped with wheels to transport over short distances.

1. Unplug the power adapter from the socket.
2. Tilt back the scale, until the scale weight is fully on the wheels.
3. Gently place the scale in its new position. Be careful not to drop the scale, this might damage the measuring results.
4. Plug the power adapter unit into the socket.



Figure 2-4. Transporting Scale

## 2.4 Setting the Device



**CAUTION:** Scale should only make contact with the ground via the foot screw.

Setup the scale in an open area away from other objects.



**IMPORTANT:** While weighing, ensure that the patient doesn't touch the scale display.

1. Place the scale on a flat, stable surface.
2. Align the scale by turning the foot screws. The air bubble in the spirit level must be precisely position in the middle of the circle.

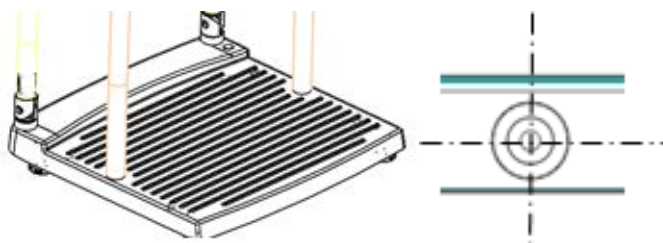

Figure 2-5. Leveling the Scale Base

## 2.5 Using the Scale



**IMPORTANT:** While weighing, ensure that the patient doesn't touch the scale display.

When folding the chair, fold it to a fully closed position. The chair might fall if not completely closed.

## 3.0 Operation

### 3.1 Keypad

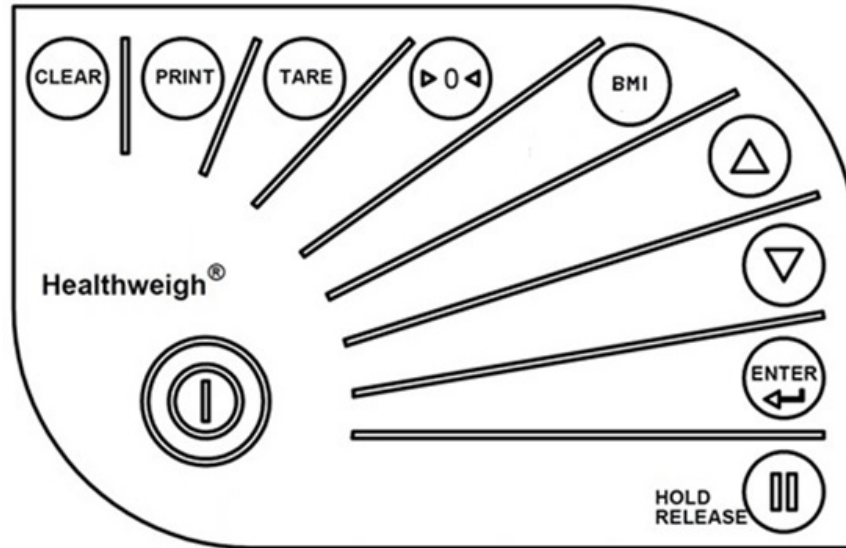

Figure 3-1. Keypad

Key	Name	Function
	On/Off	Turns the scale on or off.
	Print kg/lb	A long press will trigger a transmission of data sent out by RS232 (see <a href="#">Section 3.8 on page 14</a> ). When data is sent out from the port, the display flashes the word PRINT to acknowledge the data was sent. In configuration mode, a short press allows toggling between pounds and kilograms. No toggle in BMI mode.
	Zero	Zeroes the weight on the scale if the scale is stable. This function will only work if the weight on the scale is 2% or less of full capacity.
	Hold/Release	Pressing on this key while HOLD indicator is off will keep the most current weight value shown on the display along with the HOLD indicator. Pressing on this key while HOLD indicator is on will release the weight and turn off the HOLD indicator. This key is not active in BMI mode.
	BMI	Enters BMI mode. Only works if there is a locked weight shown on the display and the function is turned on in the configuration settings.
	Up/Down	Adjusts the value of the flashing digit/number.

Table 3-1. Keypad Functions



Key	Name	Function
	Clear	Causes the value to return to default (170.0 cm). In BMI final result display, pressing this key will return the scale to weighing mode.
	Enter	Accepts the value of the parameter last entered and moves to the next stage. A long press during scales start-up process will enter id display (before parameter mode).
	Tare	Weight under the limit will enter manual tare. If above the limit will enter tare function. NET and GROSS indicators are on according to the tare operation.

Table 3-1. Keypad Functions (Continued)

## 3.2 Display

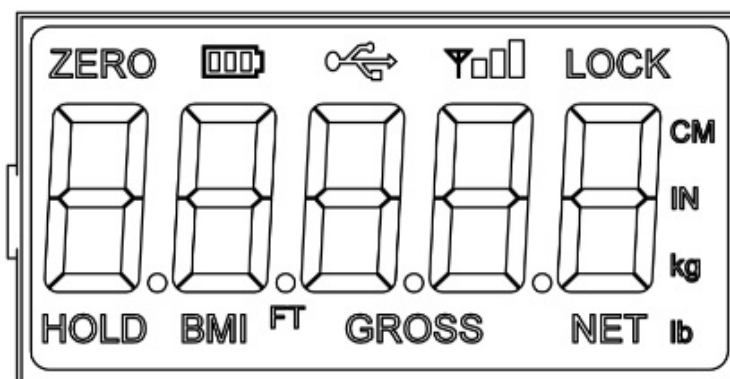

Figure 3-2. Display

Display	Description
ZERO	Scale ready for weighing
Battery Indication	Power left in the battery
USB	USB connected to the scale
LOCK	Weight is stable and the display is locked on the value
CM	Unit of length on the SI measurement system
IN	Unit of length on the Imperial and US customary measurement systems
kg	Unit of mass on the SI measurement system
lb	Unit of mass on the Imperial and US customary measurement system
NET	Indicates net weight value while tare is on
GROSS	Indicates eight value while tare is off
FT	Unit of length on the Imperial and US customary measurement system
BMI	Indicates BMI calculation is on
HOLD	Indicates weight reading will remain on screen until release (by pressing the HOLD again)
oz	Unit of mass on the Imperial and US customary measurement systems

Table 3-2. Display Descriptions

### 3.3 Scale Operation

1. Power the scale using either method below:
  - Connect the scale to the wall outlet with the AC adapter.
  - Ensure rechargeable batteries are installed.
2. Press the **ON/OFF** button to turn the scale on. The display will show *START*, display test, version number and finally *0.000*.
3. When the self-test function is complete, the digital display should read *00.0* and the charge indicator should be illuminated on the back.
4. The scale is ready to weigh a load.

### 3.4 Weighing

1. Place a weight on the scale. The digital display should blink until the weight calculation is complete.
2. Press **PRINT** to select kilograms or pounds.
3. Press **REWEIGH**. The digital display should again show the weight of the scale display.
4. To keep the weight reading, press the **HOLD** button. *HOLD* displays.
5. Remove the weight from the scale. The digital display should continue to show the weight.
6. Press the **HOLD** button. The *HOLD* indicator will disappear and the digital display should return to zero.



**WARNING:** Three beeps sound upon weighing. Make sure the **HOLD** button is released if no beeps were sounded.



**NOTE:** If the setup procedure failed, refer to the troubleshooting section for instructions. If the problem is not resolved, refer to qualified service personnel.

*The rechargeable batteries automatically recharge when the AC adapter connects to the power source.*

*When the AC adapter is inserted into power source the LED lights up red. When the battery is completely recharged the LED changes from red to green.*

*When battery is drained, connect the scale to an AC power source for at least 8 hours to recharge the battery.*

### 3.5 BMI Procedure

#### kg Mode

1. Person steps on scale while *Zero* displays.



**IMPORTANT:** While you are weighing, ensure that the patient doesn't touch the scale display.

2. Weight is display (without *HOLD* annunciator turned on).
3. Press the **BMI** button to enter BMI mode. BMI and cm indicators are on and the display shows the height's default value 170.0 cm. All digits are flashing.
4. Use **UP/DOWN** buttons to adjust the entire value. Pressing once will adjust by 0.5 cm. If you hold the key down it will keep increasing or decreasing the values.
5. Press **ENTER** to accept the values. BMI value shows on the display.
6. Pressing **CLEAR** to return to weighing mode. BMI indicator is off.



**NOTE:** The last height value entered is saved until the *Zero* is displayed or negative weight is detected. At this point, the value returns to the default value.

#### Hold/Release Function

1. When the person is on the scale, press the **HOLD\RELEASE** key.
2. When the person steps off the scale the weight will remain the same.
3. The *ZERO* indicator will not turn on. At this stage the *Zero* button will not work. The only way to return to zero from here is to press the **HOLD\RELEASE** key once more.

### Tare Function

1. When the weight is below the START parameter value press the **TARE** key.
2. The default tare value is displayed (factory programmed at 15.0 kg) while the ZERO annunciator is flashing.
3. Use the **UP/DOWN** key to adjust the value.
4. Press **ENTER** to start the tare function. NET annunciator will be turned on instead of the GROSS annunciator.

### Manual Tare

1. When the weight is above the START parameter value press the **TARE** key.
2. The tare will activate with the value that was displayed at the time of the tare activation.
3. NET annunciator will be turned on instead of the GROSS annunciator.

## 3.6 Rechargeable Battery

The indicator is supplied with a rechargeable battery, which will be inserted at the back of the indicator. The battery is secured with a Y shape crossbar, secured with two Philips screws to the indicator. A cover closes the indicator back.

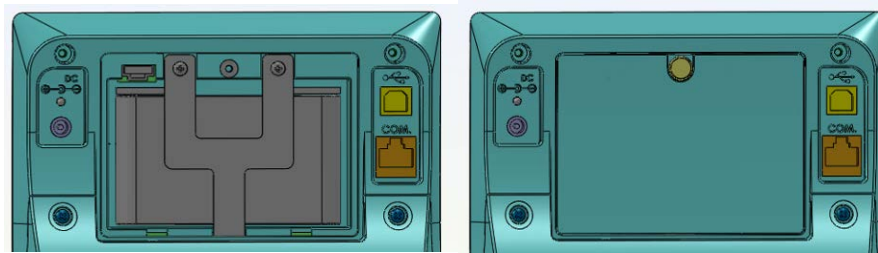

Figure 3-3. Rechargeable Battery Without Cover (left) and With Cover (right)



**NOTE:** A Philips head screwdriver is required for battery removal.



**IMPORTANT:** Dispose of batteries at appropriate waste collection centers at the end of their life cycle in accordance with local laws and regulations. Batteries and rechargeable batteries may contain harmful substances that should not be disposed of in household waste. Batteries may contain harmful substances including but not limited to: cadmium (Cd), lithium (Li), mercury (Hg) or lead (Pb). Users who dispose of batteries illegally shall face administrative sanctions as provided by law.

Battery Status	Flag Indicator
Maximum battery value	3 bars are on
Medium 2 battery value	2 bars are on
Medium 1 battery value	1 bar is on
Low battery	Battery frame
Minimum	Flashing battery frame
Critical	Scrolling "LOW BAT" and auto shutoff
No battery	Off

Table 3-3. Battery Status Indicators

- If external power supply is connected the battery flag is turned off.
- When on battery, the backlight power is reduced to 60 percent.



**NOTE:** Charge indicator LED will light RED upon connecting the power adapter. The LED will light GREEN when the rechargeable batteries are fully charged.

### 3.7 Power and Communication Connections

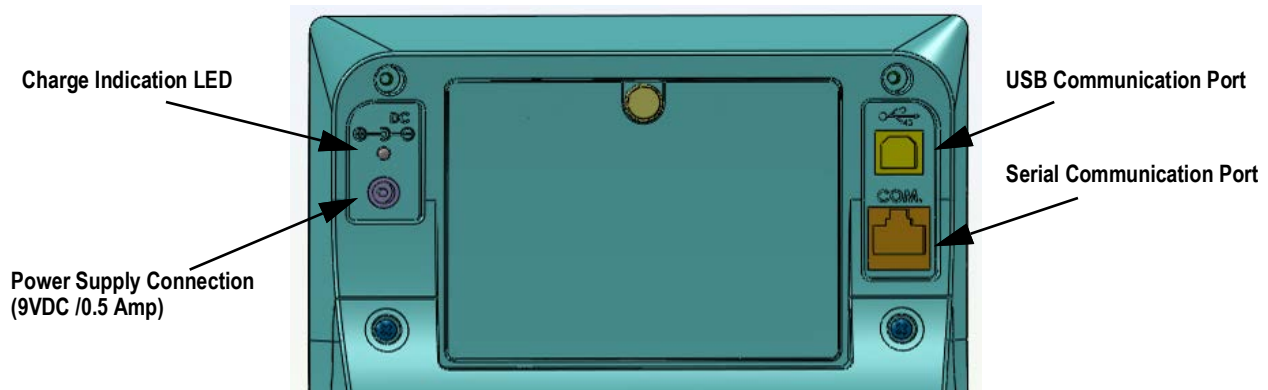

Figure 3-4. Back of Indicator

Port	Location
Serial Communication Port	The RS232 communication cable will be connected to the lower right connector, on the connectors' panel marked with the word COM. Afterward the RS232 communication cable will be connected to the computer.
USB Communication Port	The RS232 communication cable will be connected to the lower right connector, on the connectors' panel marked with the word COM. Afterward the RS232 communication cable will be connected to the computer.
Power Supply Connection	The power adapter will be connected to the left connector, on the connectors' panel, marked with power inlet specification. Afterward the power adapter will be inserted to the wall socket.

Table 3-4. Port Connection Locations

### 3.8 Communication

The scale has a communication protocol: ESC protocol. An ESC protocol is using the escape (0X1B or ASCII 27) to indicate that there is a command following. On the computer, side there must be a listener created by the vendor that will interpret this protocol. This listener must also take care of all the issues regarding data integrity, etc., to make sure that the data sent and received is valid.

Communication can be execute through either RS232 I/O port or USB I/O port. The communication parameters are:

- 9600 baud (selectable in the programming mode)
- 8 data bits
- 1 stop bit
- No parity
- No handshaking

For the USB connection, the USB driver installation will be on Windows® systems. The USB driver can be downloaded from the distributor and installation will be with the distributor's guidance. The scale support EMR protocol, for addition information contact distributor.

### 3.9 Print Button

A long press will send data from both RS232 and USB ports. When data is transmitted out via a port the display flashes the word PRINT to acknowledge the data was sent.

#### In weight mode

PATIENT WEIGHT 60.1 kg

#### In BMI (On calculated BMI display only)

For kg Unit of Measurement:

PATIENT WEIGHT 60.1 kg

PATIENT HEIGHT 170.0 cm

PATIENT BMI 20.8

In case of underweight or overweight, the word UNDER or OVER will be sent accordingly.

## 4.0 Maintenance

---

This section provides instructions for maintenance, cleaning and troubleshooting Healthweigh scale models.



**IMPORTANT:** Before first use and after periods of non-use, check the scale and batteries for proper operation and function. If the scale does not operate correctly, refer to qualified service personnel.

Check overall appearance of the scale for damage, wear and tear.

Check the batteries for damage, wear and tear. Do not use if damaged.

Inspect AC adapter for cord cracking or fraying or for broken or bent prongs.



**WARNING:** Maintenance operations not mentioned in this section, should be performed by qualified service personnel.

### 4.1 Cleaning

Proper care and cleaning is essential to ensure a long life of accurate and effective operation.



**WARNING:** Disconnect the scale from the AC power source before cleaning.



**CAUTION:** Do not immerse the scale into cleaning or other liquid solution.

Clean all external surfaces with a clean damp cloth or tissue.

### 4.2 Replacing Batteries

Use the following instructions to replace batteries:

1. Turn off the scale.
2. Disconnect the scale from the AC power source.
3. Open the batteries' cover and remove it; keep it for reassembly.
4. Insert rechargeable battery pack.
5. Close the battery cover
6. Turn on the scale.



**IMPORTANT:** Dispose of batteries at appropriate waste collection centers at the end of their life cycle in accordance with local laws and regulations. Batteries and rechargeable batteries may contain harmful substances that should not be disposed of in household waste. Batteries may contain harmful substances including but not limited to: cadmium (Cd), lithium (Li), mercury (Hg) or lead (Pb). Users who dispose of batteries illegally shall face administrative sanctions as provided by law.



**WARNING:** Replacing the rechargeable battery should be performed by qualified service personnel.

### 4.3 Calibration Procedure

Calibration to be performed by authorized personnel only



**IMPORTANT:** Scales with OIML Class III compliance have a seal to prevent any unauthorized person from performing calibration.



## 4.4 Troubleshooting

Refer to the following instructions to check and correct any failures before contacting service personnel.

Symptom	Possible Cause	Corrective Action
Scale does not turn on when using rechargeable battery	Dead battery	Connect scale to power source Replace batteries
	Faulty electrical outlet	Use a different outlet
	Bad power supply	Replace adapter
Questionable weight/ Scale does not zero	External object interfering with the scale	Check and remove all interference from the scale
	Weighing tray is not placed properly	Place the tray in its proper place
	Display did not show 0.0 kg before weighing	Remove patient, zero the scale and begin weighing process again
	Scale not placed on a stable surface	Place the scale on a stable surface and begin weighing process again
	Scale is out of calibration	Check weigh with known weight value
The display shows <i>STOP</i>	Load on the scale exceeds the capacity	Remove the excess weight and use the scale according to its limits
the display shows _____	Load is in under-load condition	Make sure the weighing tray is placed on the base
The display shows <b>LO Bat</b>	Rechargeable battery is low	Recharge the battery according to instructions

Table 4-1. Troubleshooting Checklist

Error No.	Definition	Check/Replace
SAT	A/D saturation	Check loadcell - Call technician
RTC	Error in reading Real Time Clock	Battery of real time is empty or faulty board - Call technician

Table 4-2. Error List

## 5.0 Specifications

---

### H251-10-4 Capacity and Graduation

Max 300 kg, Min 2 kg, Graduation ("e") 0.1 kg

### Power Requirements

Adapter 240V/10, 50/60Hz-9 VDC, 500 mA

Use only medically approved mains adapters compliant with EN60601-1 standards.

### Environmental

Operating Temperatures: 0°C to 40°C

Storage Temperatures: 0°C to 50°C

Humidity: 85%

Use in atmospheric pressure

### Product Dimensions

Length: 65 cm

Width: 65 cm

Display Height: 115 cm

Weight: 45 kg

### Platform Dimensions

Length: 50 cm

Width: 65 cm

Standing Platform Height: 6 cm

### Chair Dimensions

Length: 50 cm

Width: 25 cm



**WARNING:** In order to comply with EN60601-1, use UL/CE approved AC/DC adapter UE15WPC-1201255PA.

*The scale is not intended for use in the presence of flammable mixtures.*

## 6.0 Appendix

### Guidance and Manufacture's Declaration – Electromagnetic Immunity

The medical scale is suitable for use in the specified electromagnetic environment and it has meets the following immunity test levels. Higher immunity levels may cause the medical scale's essential performance lost or degraded.

Phenomenon	Basic EMC Standard or Test Method	Home healthcare facility environment
Electrostatic discharge	IEC 61000-4-2:2008	+/- 8 kV contact +/- 2 kV, +/- 4 kV, +/- 8 kV, +/- 15 kV air
Radiated RF EM fields	IEC 61000-4-3:2006+A1+A2	10 V/m 80MHz-2.7GHz 80%AM at 1kHz
Proximity fields from RF wireless communications equipment	IEC 61000-4-3:2006+A1+A2	See the RF wireless communication equipment table in "Recommended minimum separation distances".
Rated power frequency magnetic fields	IEC 61000-4-8:2009	30A/m; 50 Hz or 60Hz
Electric fast transients bursts	IEC 61000-4-4:2012	Input a.c. power PORT, Input d.c. power PORT, $\pm 2$ kV, 100kHz repetition frequency PATIENT coupling PORT, Signal input/output parts PORT: $\pm 1$ kV, 100 kHz repetition frequency
Surges	IEC 61000-4-5:2014	Input a.c. power PORT, Input d.c. power PORT, Line to line: $\pm 0.5$ kV, $\pm 1$ kV Line to earth: $\pm 0.5$ kV, $\pm 1$ kV, $\pm 2$ kV Signal input/output parts PORT? $\pm 2$ kV
Conducted disturbances induced by RF fields	IEC 61000-4-6:2013	Input a.c. power PORT, Input d.c. power PORT, PATIENT coupling PORT, Signal input/output parts PORT 3 V in 0.15 MHz - 80 MHz 6 V in ISM and/or amateur radio bands between 0.15 MHz and 80 MHz 80 % AM at 1kHz
Voltage dips	IEC 61000-4-11:2004	0% $U_T$ : 0.5 cycle at 0°, 45°, 90°, 135°, 180°, 225°, 270°, and 315° 0% $U_T$ : 1 cycle and 70% $U_T$ : 25/30 cycles sine phase at 0°
Voltage interruptions	IEC 61000-4-11:2004	0% $U_T$ : 250/300 cycle
Proximity magnetic fields immunity test	IEC 61000-4-39:2017	No. Test frequency Modulation Immunity test level (A/m)  30 kHz CW 8  134.2 kHz Pulse modulation, 2.1 kHz 65  13.56 MHz Pulse modulation, 50 kHz 7.5
$U_T$ : rated voltage(s); E.g. 25/30 cycles means 25 cycles at 50Hz or 30 cycles at 60Hz		

## Guidance and Manufacture's Declaration – Electromagnetic Emissions

The medical scale is suitable for use in the specified electromagnetic environment and it has meets the following standard's emission requirements.

Phenomenon	Profession Healthcare Facility Environment	Home Healthcare Environment
Conducted and radiated RF emissions	CISPR 11, Group 1, Class B	CISPR 11, Group 1, Class B
Harmonic distortion	IEC 61000-3-2:2005+A1+A2, Class A	IEC 61000-3-2:2005+A1+A2, Class A
Voltage fluctuations and flicker	IEC 61000-3-3:2013	IEC 61000-3-3:2013

## Recommended Minimum Separation Distances

Nowadays, many RF wireless equipments have being used in various healthcare locations where medical equipment and/or systems are used. When they are used in close proximity to medical equipment and/or systems, the medical equipment and/or systems' basic safety and essential performance may be affected. This medical scale has been tested with the immunity test level in the below table and meet the related requirements of IEC 60601-1-2:2014. The customer and/or user should help keep a minimum distance between RF wireless communications equipment and this medical scale as recommended below.

Test Frequency (MHz)	Band (MHz)	Service	Modulation	Maximum Power (W)	Distance (m)	Immunity Test Level (V/m)
385	380-390	TETRA 400	Pulse modulation 18Hz	1.8	0.3	27
450	430-470	GMRS 460 FRS 460	FM ± 5 kHz deviation 1 kHz sine	2	0.3	28
710	704-787	LTE Band 13, 17	Pulse modulation 217Hz	0.2	0.3	9
745						
780						
810	800-960	GSM 800/900, TETRA 800, iDEN 820, CDMA 850, LTE Band 5	Pulse modulation 18Hz	2	0.3	28
870						
930						
1720	1700-1990	GSM 1800; CDMA 1900; GSM 1900; DECT; LTE Band 1, 3, 4, 25; UMTS	Pulse modulation 217Hz	2	0.3	28
1845						
1970						
2450	2400-2570	Bluetooth, WLAN, 802.11 b/g/n, RFID 2450, LTE Band 7	Pulse modulation 217Hz	2	0.3	28
5240	5100-5800	WLAN 802.11 a/n	Pulse modulation 217Hz	0.2	0.3	9
5500						
5785						





© Rice Lake Weighing Systems Content subject to change without notice.

230 W. Coleman St. • Rice Lake, WI 54868 • USA USA: 800-472-6703 • International: +1-715-234-9171