

# 1280 Enterprise™ Series

*Color Touchscreen Programmable Indicator*

*Version 2.06*

## Technical Manual



© Rice Lake Weighing Systems. All rights reserved.

Rice Lake Weighing Systems® is a registered trademark of  
Rice Lake Weighing Systems.

All other brand or product names within this publication are trademarks or  
registered trademarks of their respective companies.

All information contained within this publication is, to the best of our knowledge, complete and  
accurate at the time of publication. Rice Lake Weighing Systems reserves the right to make  
changes to the technology, features, specifications and design of the equipment without notice.

The most current version of this publication, software, firmware and all other product  
updates can be found on our website:

[www.ricelake.com](http://www.ricelake.com)

# Revision History

This section tracks and describes manual revisions for awareness of major updates.

Revision	Date	Description
–	January 2016	Initial manual release with the launch of the product; firmware version 1.0
N	July 12, 2022	Revision history established; firmware version 2.05 <ul style="list-style-type: none"> <li>• Added Diagnostics key to main UI virtual keypad</li> <li>• Enhanced Total Scale capability</li> <li>• Enhanced TCP Command Server capability</li> <li>• iQUBE diagnostic graphic</li> <li>• Added Memory Commands</li> <li>• Added Touch Screen Commands</li> <li>• Emphasized existing content regarding grounding cables</li> <li>• Updated menu options in Revolution</li> <li>• Added overload and underload errors</li> </ul>
O	March 28, 2023	Australia regulatory mode added; firmware version 2.05.04
P	July 14, 2023	Second generation A/D scale cards added
Q	January 2, 2024	Updated menu and capabilities; firmware version 2.06.00
R	March 1, 2024	Added first and second generation option card details
S	July 8, 2024	Universal mount tilt stand dimensions updated to reflect new holes to accommodate optional floor stand
T	August 12, 2024	Added setpoint examples, updated images

Table i. Revision Letter History



Technical training seminars are available through Rice Lake Weighing Systems. Course descriptions and dates can be viewed at [www.ricelake.com/training](http://www.ricelake.com/training) or obtained by calling 715-234-9171 and asking for the training department.

# Contents

<b>1.0</b>	<b>Introduction</b>	<b>9</b>
1.1	Safety	9
1.2	Features	10
1.2.1	Other Features	10
1.2.2	Enclosure Types	10
1.2.3	Option Cards	10
1.3	FCC Compliance	10
1.4	Weigh Mode	11
1.5	Numeric/Alpha Entry	12
1.6	Main Menu User Interface	13
1.6.1	Calibration	13
1.6.2	Setpoints	14
1.6.3	Audit Trail	14
1.6.4	Language	15
1.6.5	Return to Weigh Mode	15
1.7	Indicator Virtual Keypad Operation	15
1.7.1	Toggle Gross/Net Mode	16
1.7.2	Toggle Units	16
1.7.3	Zero Scale	16
1.7.4	Tare	16
1.7.5	Print Ticket	16
1.7.6	Diagnostics	16
1.7.7	Accumulator Functions	17
1.7.8	Peak Hold	17
1.7.9	Softkey Setup	17
1.8	Keypad Operations	18
1.8.1	Navigation Keys	18
1.8.2	Numeric Keypad	18
1.8.3	Toggle Gross/Net Mode	18
1.8.4	Toggle Units	18
1.8.5	Zero Scale	18
1.8.6	Tare	19
1.8.7	Print Ticket	19
1.8.8	Accumulator Functions	19
1.9	Alibi Storage	20
1.10	Peak Hold	20
1.11	Rate Of Change	20
1.12	Setpoint Entry	20
1.13	Softkey Operations	21
1.14	Error Conditions	21
<b>2.0</b>	<b>Installation</b>	<b>22</b>
2.1	Unpacking	22
2.2	Mounting/Assembly	22
2.2.1	Torque Values	22
2.2.2	Universal Mount Enclosure with Tilt Stand	23
2.2.3	Wall Mount Enclosure	27
2.2.4	Panel Mount Installation	30



Rice Lake continually offers web-based video training on a growing selection of product-related topics at no cost. Visit [www.ricelake.com/webinars](http://www.ricelake.com/webinars)

2.3	Cable Connections	35
2.3.1	Water/Dust Tight Cord Grips	35
2.3.2	Shield Grounding Through Cord Grips	36
2.3.3	Shield Grounding with Clamp and Ground Stud	36
2.3.4	ESD Grounding for Touch Only Models	37
2.3.5	Load Cells	39
2.3.6	Serial Communications	40
2.3.7	CPU Digital I/O Wiring	41
2.4	Wiring Schematics	42
2.4.1	Key Pad Model	42
2.4.2	Touch Screen Only (Virtual Keypad)	43
2.5	Configuration Methods	43
2.6	CPU Board Replacement	44
2.6.1	Remove CPU Board from Face Plate	44
2.7	Power Supply Replacement	45
2.8	Replace Fan Plate and Back Plane	46
2.9	Replacement Parts	47
2.10	Label Legend	56
<b>3.0</b>	<b>Configuration Menu</b>	<b>57</b>
3.1	Access Setup Parameters	57
3.2	Access Configuration Menu – Sealed Indicator	57
3.3	Configuration Menu	59
<b>4.0</b>	<b>Scale Configuration</b>	<b>61</b>
4.1	Scale Kind	61
4.1.1	Scale Alias	62
4.1.2	Scale Format	63
4.1.3	Split Mode	64
4.2	Scale Calibration	65
4.2.1	Standard Calibration	65
4.2.2	Multi-Point Calibration	67
4.2.3	Last Zero Calibration	67
4.2.4	Temporary Zero Calibration	67
4.2.5	Theoretical Calibration	68
4.3	Scale Filtering	68
4.3.1	Adaptive Digital Filter	69
4.3.2	Three Stage Filter	69
4.4	Scales Setup	70
4.5	Maintenance	71
4.6	Serial Scale Type	71
4.6.1	Legal for Trade	71
4.6.2	Industrial Scales	72
4.6.3	Configuration	72
<b>5.0</b>	<b>Communications</b>	<b>73</b>
5.1	Serial Menu	74
5.2	Ethernet Menu	75
5.2.1	Using an Internet Browser as a Remote Display	76
5.2.2	Resetting the Network Connection	76
5.2.3	Wired Adapter	76



Technical training seminars are available through Rice Lake Weighing Systems. Course descriptions and dates can be viewed at [www.ricelake.com/training](http://www.ricelake.com/training) or obtained by calling 715-234-9171 and asking for the training department.

5.2.4	Wi-Fi Adapter .....	77
5.2.5	Wi-Fi Direct .....	77
5.2.6	TCP Command Server .....	79
5.2.7	Stream Server .....	79
5.2.8	TCP Client 1, 2 & 3 .....	79
5.3	Fieldbus Menu .....	80
5.4	iQUBE <sup>2</sup> Scale .....	80
<b>6.0</b>	<b>Features .....</b>	<b>81</b>
6.1	Softkeys .....	82
6.1.1	Enable/Disable Softkeys .....	82
6.1.2	Predefined Softkeys .....	82
6.1.3	Database Softkey .....	83
6.1.4	LaserLight Softkey .....	84
6.2	General Parameters .....	84
6.2.1	Local/Remote Operation .....	85
6.3	Regulatory .....	85
6.4	Passwords .....	88
6.5	Locale .....	88
6.6	Contact Info .....	89
6.7	FTP Server .....	89
6.7.1	Set FTP Server Password .....	89
6.7.2	Initialize FTP Server .....	90
6.8	Advanced Printing .....	90
6.9	View Alibi Storage .....	91
<b>7.0</b>	<b>Formats .....</b>	<b>92</b>
7.1	Print Format .....	93
7.1.1	Default Print Formats .....	93
7.1.2	Print Format Destination Ports .....	94
7.1.3	Print Format Tokens .....	94
7.2	Stream Format Menu .....	96
7.2.1	Stream Format Tokens .....	97
<b>8.0</b>	<b>Digital I/O .....</b>	<b>99</b>
<b>9.0</b>	<b>Analog Output .....</b>	<b>101</b>
<b>10.0</b>	<b>Setpoints .....</b>	<b>103</b>
10.1	Select Setpoint for Configuration .....	104
10.2	Setpoint Configuration .....	106
10.2.1	Targets .....	111
10.2.2	Preacts .....	112
10.2.3	Actions .....	112
10.2.4	Digital I/O .....	112
10.2.5	Settings .....	112
10.3	Batch Operations .....	113
10.4	Batching Examples .....	115
10.4.1	Example 1 .....	115
10.4.2	Example 2 .....	116
<b>11.0</b>	<b>Diagnostics .....</b>	<b>117</b>



Rice Lake continually offers web-based video training on a growing selection of product-related topics at no cost. Visit [www.ricelake.com/webinars](http://www.ricelake.com/webinars)

<b>12.0 System Settings</b> .....	<b>118</b>
12.1 Devices .....	119
12.2 Email .....	120
12.3 Updating the A/D Scale Card Firmware .....	121
12.3.1 First Generation Scale Card Firmware Loading Procedure .....	122
12.3.2 Second Generation Option Card Firmware Updating Procedure .....	123
<b>13.0 Option Cards</b> .....	<b>124</b>
13.1 Hardware Serial Command .....	124
13.2 Option Card Firmware .....	124
<b>14.0 Importing/Exporting</b> .....	<b>125</b>
14.1 Importing Configuration .....	125
14.1.1 Importing Built-in iRite Configuration .....	126
14.1.2 Importing Revolution Files from a Flash Drive or Micro SD Card .....	126
14.2 Importing iRite™ Programs .....	126
14.2.1 Importing Built-in iRite Programs .....	126
14.2.2 Importing iRite from a Flash Drive or Micro SD Card .....	127
14.2.3 Send Configuration from Revolution to Device .....	127
14.3 Importing Database Data .....	128
14.3.1 Importing Databases from a Flash Drive or Micro SD Card .....	128
14.3.2 Downloading Databases to the 1280 .....	128
14.4 Exporting Configuration .....	129
14.4.1 Exporting to Flash Drive or Micro SD Card .....	129
14.4.2 Get Configuration From Device to Revolution .....	129
14.5 Exporting Database Data .....	129
14.5.1 Exporting Database to Flash Drive or Micro SD Card .....	129
14.5.2 Saving Databases from the 1280 to a PC .....	130
14.6 Exporting Diagnostic Log .....	130
14.7 Connecting to the Indicator from Revolution .....	130
14.8 Current Firmware .....	132
14.8.1 Check Current Firmware .....	132
14.9 Updating Firmware with USB Flash Drive .....	133
14.9.1 Download Firmware to USB .....	133
14.9.2 Update Firmware to 1280 .....	133
14.9.3 Errors .....	135
14.10 Updating Firmware from the Network .....	137
14.10.1 Errors .....	138
14.10.2 Switch Firmware Versions .....	138
14.11 Visual Studio Code – iRite .....	140
<b>15.0 Display Editor</b> .....	<b>141</b>
15.1 Configurable Splash Screen .....	141
15.2 Widgets .....	141
15.2.1 Scale Widgets .....	143
15.2.2 Bitmap Widgets .....	144
15.2.3 Bar Graph Widgets .....	145
15.2.4 Label Widgets .....	146
15.2.5 Symbol Widgets .....	147
15.2.6 Image Widgets .....	148
15.2.7 Chart Widgets .....	151



Technical training seminars are available through Rice Lake Weighing Systems. Course descriptions and dates can be viewed at [www.ricelake.com/training](http://www.ricelake.com/training) or obtained by calling 715-234-9171 and asking for the training department.

15.2.8	Line Widgets .....	152
15.2.9	Softkey Widgets .....	153
15.3	Widget Colors .....	154
<b>16.0</b>	<b>EDP Commands .....</b>	<b>157</b>
16.1	Key Press Commands .....	157
16.2	Reporting Commands .....	158
16.3	Clear and Reset Commands .....	158
16.4	Parameter Setting Commands .....	159
16.4.1	Scales Commands .....	159
16.4.2	Communication Commands .....	162
16.4.3	Feature Commands .....	165
16.4.4	Regulatory Commands .....	166
16.4.5	Print Format Commands .....	168
16.4.6	Display Widget Commands .....	169
16.4.7	Digital Input/Output Commands .....	170
16.4.8	Analog Output Commands .....	170
16.4.9	Fieldbus Commands .....	170
16.5	Weigh Mode Commands .....	170
16.6	Batching Control Commands .....	171
16.7	Database Commands .....	172
16.8	iQUBE <sup>2</sup> Configuration Commands .....	174
16.9	1280 Calibration Using Serial Commands .....	174
16.10	Net Update Commands .....	175
<b>17.0</b>	<b>Compliance .....</b>	<b>176</b>
<b>18.0</b>	<b>Specifications .....</b>	<b>178</b>



Rice Lake continually offers web-based video training on a growing selection of product-related topics at no cost. Visit [www.ricelake.com/webinars](http://www.ricelake.com/webinars)



## 1.0 Introduction

This manual is intended for use by service technicians responsible for installing and servicing 1280 Enterprise Series digital weight indicators.



Manuals are available from Rice Lake Weighing Systems at [www.ricelake.com/manuals](http://www.ricelake.com/manuals)

Warranty information is available at [www.ricelake.com/warranties](http://www.ricelake.com/warranties)

### 1.1 Safety

#### Safety Definitions:



**DANGER:** Indicates an imminently hazardous situation that, if not avoided, will result in death or serious injury. Includes hazards that are exposed when guards are removed.



**WARNING:** Indicates a potentially hazardous situation that, if not avoided, could result in serious injury or death. Includes hazards that are exposed when guards are removed.



**CAUTION:** Indicates a potentially hazardous situation that, if not avoided, could result in minor or moderate injury.



**IMPORTANT:** Indicates information about procedures that, if not observed, could result in damage to equipment or corruption to and loss of data.

#### General Safety



**Do not operate or work on this equipment unless this manual has been read and all instructions are understood. Failure to follow the instructions or heed the warnings could result in injury or death. Contact any Rice Lake Weighing Systems dealer for replacement manuals.**



**WARNING:** Failure to heed could result in serious injury or death.

*Some procedures described in this manual require work inside the indicator enclosure. These procedures are to be performed by qualified service personnel only.*

*Do not allow minors (children) or inexperienced persons to operate this unit.*

*Do not operate without enclosure completely assembled.*

*Do not place fingers into slots or possible pinch points.*

*Do not use this product if any of the components are cracked.*

*Do not make alterations or modifications to the unit.*

*Do not remove or obscure warning labels.*

*Do not submerge.*

*Before opening the unit, ensure the power cord is disconnected from the power source.*

*Disconnect all power before servicing. Multiple power sources may be present. Failure to do so may cause property damage, personal injury or death.*

*For permanently connected equipment, a readily accessible disconnect device shall be incorporated in the building installation wiring.*

*Pluggable units must be installed near the socket/outlet and be easily accessible.*

*Use copper or copper-clad aluminum conductors only.*

### 1.2 Disposal



#### Product Disposal

The product must be brought to appropriate separate waste collection centers at the end of its life cycle.

Proper separate collection to recycle the product helps prevent possible negative effects on the environment and to health, and promotes the recycling of the materials. Users who dispose of the product illegally shall face administrative sanctions as provided by law.

## 1.3 Features

Features of the 1280 include:

- Support for up to eight scales (combination of analog load cell, total, serial scales or program scales)
- Eight programmable Digital I/O bits available on the CPU board (connector J1) including onboard pulse input pins, with 24 additional per option card
- Two communication ports which support RS-232, RS-485 and RS-422
- Two USB host ports
- One USB device port
- AC or DC power options
- Ethernet – wired, Wi-Fi and Wi-Fi Direct
- Bluetooth functionality not accessible in Version 2.00

### 1.3.1 Other Features

- Built in Web Server for remote access to screens
- Configurable print formats can be defined for up to 1000 characters; additional print formats can be created with iRite
- Includes truck in/out, recipe batching, counting, checkweighing and filling/dosing iRite programs and source codes
- 100 configurable setpoints
- The 1280 is NTEP, OIML, Measurement Canada and Australian Government certified (see [Section 18.0 on page 178](#))

### 1.3.2 Enclosure Types

- Universal
- Panel Mount – numeric keypad
- Panel Mount – touch-only (7 in and 12 in display)
- Wall Mount

### 1.3.3 Option Cards

The CPU board provides six slots for installing scale or other option cards. Available option cards include:

- Single- and dual-channel scale cards to drive up to sixteen 350 ohm load cells per card; scale cards support both 4- and 6-wire load cell connections
- Single- and dual-channel analog output card for 0–10 VDC, 0–20 mA or 4–20 mA tracking of gross or net weight values
- 24-channel digital I/O expansion card
- Dual channel serial port card (with RS-232, RS-422 and RS-485)
- Dual channel analog input card for  $\pm 100$  mV,  $\pm 10$  VDC, 0–20 mA or 4–20 mA
- 4-channel relay card
- CompactCom card which supports EtherNet/IP™, DeviceNet™, ProfiNet, Profibus® DP Modbus TCP, and EtherCAT networks

## 1.4 FCC Compliance

### United States

This equipment has been tested and found to comply with the limits for a Class A digital device, pursuant to Part 15 of the FCC Rules. These limits are designed to provide reasonable protection against harmful interference when the equipment is operated in a commercial environment. This equipment generates, uses and can radiate radio frequency energy and, if not installed and used in accordance with the instruction manual, may cause harmful interference to radio communications. Operation of this equipment in a residential area is likely to cause harmful interference in which case the user will be required to correct the interference at his own expense.

### Canada

This digital apparatus does not exceed the Class A limits for radio noise emissions from digital apparatus set out in the Radio Interference Regulations of the Canadian Department of Communications.

Le présent appareil numérique n'émet pas de bruits radioélectriques dépassant les limites applicables aux appareils numériques de la Class A prescrites dans le Règlement sur le brouillage radioélectrique édicté par le ministère des Communications du Canada.

## 1.5 Weigh Mode

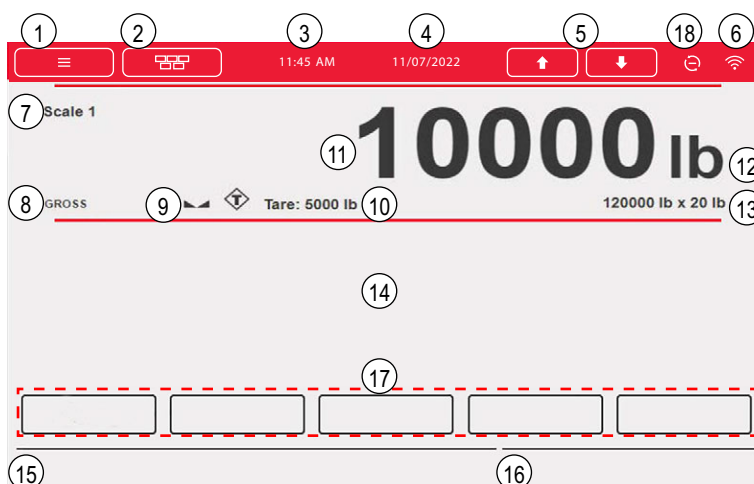

Figure 1-1. Weighing Mode Display Screen



**NOTE:** The display illustrations in this manual are for reference only, they can be different from default illustrations depending on the colors, graphics or programs which have been loaded.

Item No.	Description
Status Bar	
1	Menu key – press to enter setup menus and audit trail information
2	Virtual keypad – press to enter; <b>Zero, Tare, Gross/Net, Print, Units</b> and <b>Diagnostics</b> keys are identical to the physical keys located on the front panel
3	Current time – press to set the time <b>NOTE: Current time must be set accurately for some functions to work</b>
4	Current date – press to set the date <b>NOTE: Current Date must be set accurately for some functions to work</b>
5	Scale arrows – use to scroll through the attached scales in the current scale area (up to eight scales)
6	Wi-Fi Symbol - indicates Wi-Fi signal strength; when faded, Wi-Fi is not connected or out of range; press on the symbol to display the <b>Network Information Screen</b> which includes information on Wired Ethernet, Wi-Fi and Wi-Fi Direct; allows restart all network connections
18	Net Update firmware status icon - indicates if a newer Net Update firmware is available
Weight Display Area	
7	Current scale – number of currently displayed scale
8	Gross/Net – current weighing mode
9	Standstill icon – indicates scale is stable
10	Tare – weight of tare in system
11	Weight reading for current scale
12	Unit of measure
13	Capacity and division size (values are for illustration only)
14	Application area – contains configuration of widgets (text boxes, bar graphs, icons and others)
15	Display line for text (messages from an iRite program)
16	System messages or status (batch running, print queued and others)
Softkeys	
17	Softkeys – five softkeys which can be setup from the default list, or user defined custom text and iRite programming functionality; these can be removed for more screen customization

Table 1-1. Weigh Mode Display



**NOTE:** When a system reset is performed (Version 1.05 and later) the Weigh Mode display is populated with a scale widget and a softkey widget. This gives end users access to softkey setup without having to use EDP commands or revolution.

## 1.6 Numeric/Alpha Entry

When data entry is required, a keyboard or a numeric keypad displays on the screen. The indicator's front panel is also equipped with a numeric keypad.

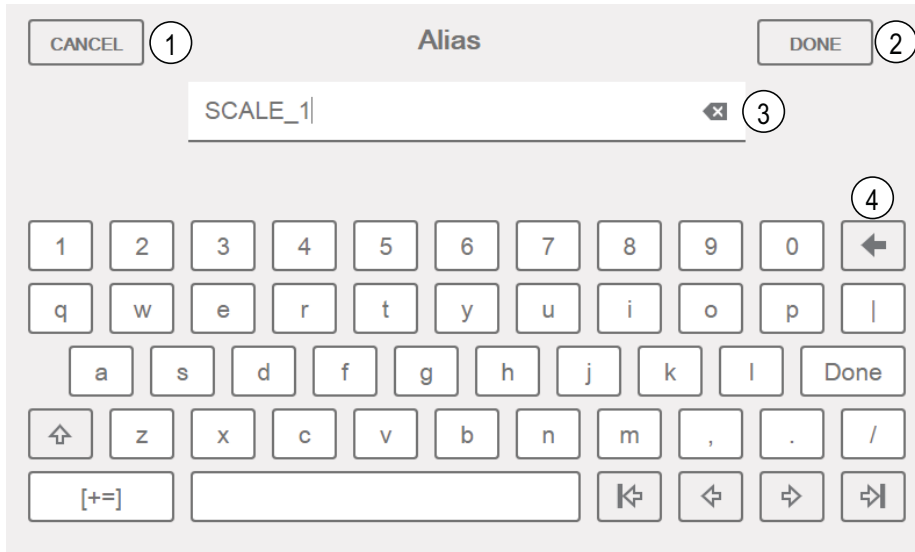

Figure 1-2. On-screen Alphanumeric Keyboard

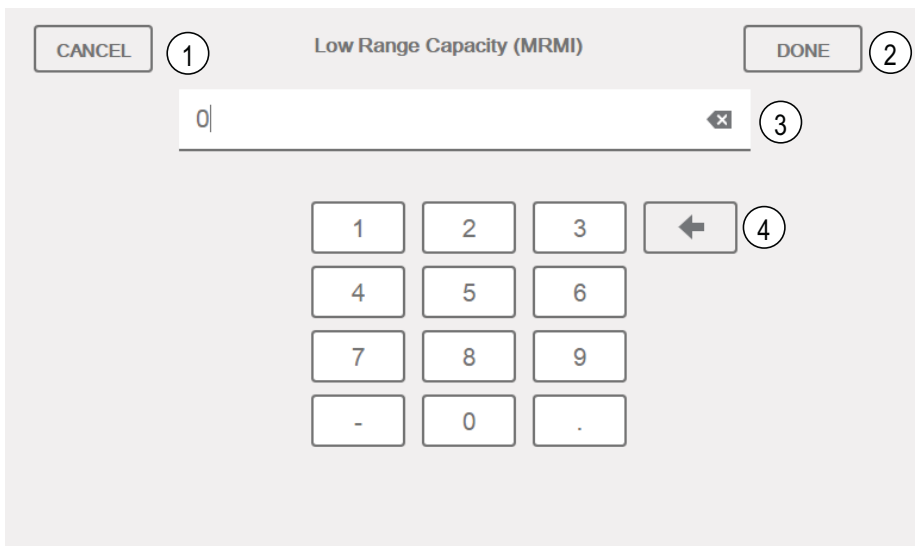

Figure 1-3. On-screen Numeric Keypad

Item No.	Description
1	Cancel – exits keyboard
2	Done – completes keyboard entry
3	Clear – deletes everything in the prompt line
4	Backspace – deletes one character at a time

Table 1-2. Keyboard Descriptions

## 1.7 Main Menu User Interface

The Main Menu allows the operator access to Configuration, Calibration, Setpoint Values, Audit Trail and Language.

From the weigh mode, press  to enter the main menu.

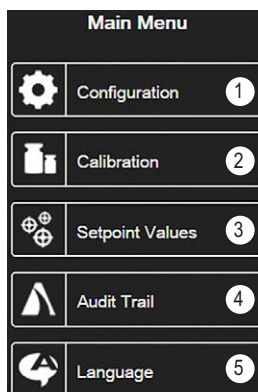









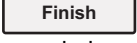

Figure 1-4. Main Menu User Interface

Item No.	Description
1	Configuration – may be inaccessible to the operator by password protection
2	Calibration – allows the operator to perform a calibration
3	Setpoint Values – access to setpoint targets and settings
4	Audit Trail – view number of configuration and calibration edits, plus the last calibration date
5	Language – allows scale language to be changed

Table 1-3. Main Menu User Interface

### 1.7.1 Calibration

Use the following steps to perform a standard calibration on a scale.

1. Select the scale to be calibrated and enter the calibration menu.
2. Press .
3. Select the method of calibration. Press .
4. Select if chains, hooks or other items are being used with the weights during calibration.
5. Press .
6. Remove all weight from the scale except for chains and hooks (if used).
7. Press . The current weight and **Zero Calibration Complete** displays.
8. Press .
9. Enter span weight for the value of the calibration test weights used to calibrate the scale. This is required prior to running the span calibration.
10. With the test weight on the scale platform and the test weight value entered into the calibration weight window, the corresponding scale span value is ready to be calibrated.
11. Press . The current span weight displays.
12. Press . Calibration results display.
13. Press . Display returns to Calibration menu.
14. If hooks or chains were used during calibration, remove these and the test weights from the scale. The re-zero function is used to remove a calibration offset when hooks or chains are used to hang the test weights during both zero and span calibration.
15. Press .

## 1.7.2 Setpoints

Targets are a set of values which when met, cause the setpoint to trip.

Parameter	Default	Description
Value	0	Setpoint Value: Weight-based – specifies the target weight value, 0–9999999 Time-based – specifies time in 0.1 second intervals, range 0–65535 Counter – specifies the number of consecutive batches to run, range 0–65535
Source	Scale 1	Select Scale 1–8
Trip	Higher	Specifies if the setpoint is satisfied when the weight is higher or lower than the setpoint value, within a band established around the value or outside of the band; in a batch sequence with: <ul style="list-style-type: none"> <li>• <b>Trip = Higher</b> – associated digital output is active until the setpoint value is exceeded</li> <li>• <b>Trip = Lower</b> – output is active until the weight goes below the setpoint value</li> <li>• <b>Trip = Inband</b> – setpoint is satisfied when the weight is within a band established around the value</li> <li>• <b>Trip = Outband</b> – setpoint is satisfied when weight is outside a band established around the value, excluding the value</li> </ul>

Table 1-4. Target Parameters

Settings allow the operator to select the mode of the setpoint (batch or free-running). If enabled, it can be accessed by softkey, for defining a name and optional prompt.

Parameter	Default	Description
Batch	Off	Specifies whether the setpoint is used as a batch (On) or continuous (Off) setpoint
Access	On	Specifies the access allowed to setpoint parameters display by pressing the <b>Setpoint</b> softkey in weigh mode; if set to <b>Off</b> , values can be displayed but not changed; if set to <b>Hide</b> , values do not display
Enable	On	Turns the setpoint on or off
Alias	--	Enter a name for the setpoint
Prompt	--	Alphanumeric message or prompt which can be displayed in a label widget

Table 1-5. Setpoint Parameters

## 1.7.3 Audit Trail

Audit trail support provides tracking information for configuration and calibration events. A separate calibration and configuration counter is provided for each scale; a single system configuration counter tracks all global changes applied to multiple scales.

To prevent misuse, unsaved configuration or calibration changes are counted as change events; restoration of the previous saved configuration or calibration is also counted.

Select to view the legally relevant version, the configuration counters and the calibration counters.

1. Press  to send the audit trail data out the configured communications port (default is port 1).
2. Select  to return to weigh mode.

Audit Trail			
Legally Relevant Version: 1.0			
Regulatory Agency: NTEP			
	Configuration	Calibration	Last Calibration Date
System	0		
Scale 1	5	4	02:34 PM 04/10/2015
Scale 2	2	2	02:34 PM 04/10/2015
Scale 3	2	0	
Scale 4	2	2	02:34 PM 04/10/2015
Scale 5	2	2	02:34 PM 04/10/2015
Scale 6	2	0	
Scale 7	2	2	02:34 PM 04/10/2015
Scale 8	0	0	

Figure 1-5. Audit Trail Screen

## 1.7.4 Language

The 1280 has 16 language choices, setting the language is only available in weigh mode. Configuration mode remains in English.

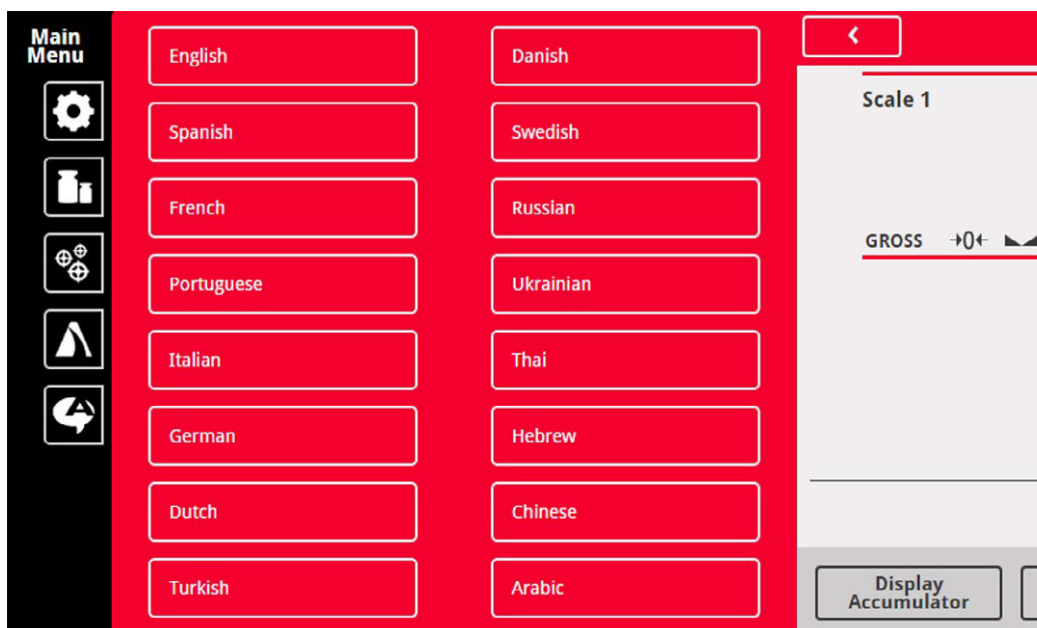
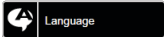



Figure 1-6. Language Selections

1. Press  to display the list of available languages.
2. Select the desired language.
3. Press  to save the selection and return to the weigh mode.

## 1.7.5 Return to Weigh Mode

When settings are complete for Configuration, Calibration or Setpoint Values, press .



displays for a few seconds then display returns to the weigh mode.

## 1.8 Indicator Virtual Keypad Operation

Press  to open the virtual keypad. **Zero**, **Tare**, **Gross/Net**, **Print**, **Units** and **Diagnostics** function the same as the physical keys located on the front panel of the keyed 1280.

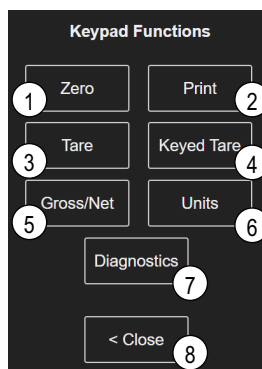

Figure 1-7. Virtual Keypad Functions

**Keyed Tare** is the equivalent to the keyed tare softkey. Press , a numeric keypad displays to enter a tare value.

### 1.8.1 Toggle Gross/Net Mode

Press  to toggle the display mode between gross and net.

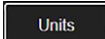

- If a tared value is in the system, **Net** is displayed (net equals gross minus tare)
- If there is no tare in the system, **Gross** is displayed

### 1.8.2 Toggle Units

Press  to toggle between primary, secondary and tertiary units.

### 1.8.3 Zero Scale

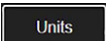
Use the following steps to zero the scale (if it is within the acceptable zero range).



1. In gross mode, remove all weight from the scale and wait for  to display.
2. Press . When  displays, the scale is zeroed.

### 1.8.4 Tare

Use the following instructions to acquire a tare, remove a stored tare and enter a tare using the display softkeys.



#### Acquire Tare

Used to store the weight currently on the scale as a tare weight and switch to net mode.

1. Place a container on the scale and wait for  to display.
2. Press . Net displays, indicating the weight has been tared.

#### Remove Stored Tare Value

Used to remove a stored tare value.

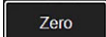
1. Remove all weight from the scale to obtain gross zero.
2. When  displays, press  (in OIML mode, press ). Gross displays.

Alternatively, remove a stored tare value using a keyed tare of zero.

#### Keyed Tare



Used to add a keyed tare.

1. Press . A numeric keypad displays.
2. Enter a value and press **Done**.

### 1.8.5 Print Ticket

Press  to send the gross or net ticket format to the configured serial, USB or Ethernet port associated with its ticket format. When displaying the accumulator, it prints the accumulator format.

To print tickets using auxiliary formats (1–20), press the  softkey (not part of virtual keypad).

1. Wait for  to display.
2. Press .
3. Enter an auxiliary format number (1–20) and press **Done** to send the date to the serial port.

### 1.8.6 Diagnostics

Displays iQUBE<sup>2</sup> diagnostics screen if installed.



## 1.8.7 Accumulator Functions

### Acquiring Weight

If the accumulator is enabled while in configuration, weight is accumulated whenever a print operation is performed by:

- Pressing 
- Activating a digital input print
- Receiving a KPRINT serial command
- iRite calling the PRINT ( ) function
- Activating the accumulator with a setpoint

The scale must return to zero before the next accumulation.

### Display or Clear the Accumulator

- A softkey can be programmed for each function
- A Display or Clear Accumulator Digital Input can be activated (ClearAccum0 iRite API, can be cleared with a setpoint)
- A serial command can be sent

### Print the Accumulated Value



To print the accumulated value, press  while displaying the accumulator.

## 1.8.8 Peak Hold

Peak hold is used to determine, display and print the greatest weight reading during a weighing cycle.

There are three types of peak hold: automatic, manual and bi-directional.

To use the peak hold function:

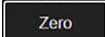
1. Tare the scale to put it into net mode.
2. Increase the weight. As the weight increases, the indicator captures and holds the highest weight recorded.
3. Press  to see the real live weight (as opposed to the peak hold weight).
4. Press  or  to clear the peak hold (it clears automatically when set to **Automatic Mode**).

## 1.8.9 Softkey Setup

The standard 7 in panel mount has front panel keys, navigation softkeys and a virtual keypad. The 7 in and 12 in key-less panel mounts only support a virtual keypad.

1. To enter navigation softkey designations for the 7 in panel mount, navigate to the main menu and select **Configuration/Features/Softkeys**.
2. Press .
3. Scroll to the desired softkey and press **Done**.



Figure 1-8. Softkeys

## 1.9 Keypad Operations



Figure 1-9. 1280 Front Panel

### 1.9.1 Navigation Keys

Navigation keys are primarily linked to iRite handlers. If no iRite handlers exist, the navigation keys toggle through a selection of displayed scales.

### 1.9.2 Numeric Keypad

Use the numeric keypad for entering numbers or keyed tares.

Press **CLEAR** to backspace when entering numbers/letters.

Press **ENTER** to save entries from the numeric keypad.

### 1.9.3 Toggle Gross/Net Mode

Pressing **GROSS B/N NET** toggles the display mode between gross and net.

- If a tared value is in the system, **Net** is displayed (net equals gross minus tare)
- If there is no tare in the system, **Gross** is displayed

### 1.9.4 Toggle Units

Pressing **UNITS** toggles between primary, secondary and tertiary units.

### 1.9.5 Zero Scale

Use the following instructions to zero the scale (if it is within the acceptable zero range).



1. In gross mode, remove all weight from the scale and wait for **▲▲** to display.
2. Press **ZERO**. When **→0←** displays, the scale is zeroed.

## 1.9.6 Tare

Use the following instructions to acquire a tare, remove a stored tare and enter a tare using the keyboard.



### Acquire Tare

Used to store the weight currently on scale as tare weight and switch to net mode.

1. Place container on scale and wait for  to display.
2. Press . **Net** displays indicating the weight has been tared.

### Remove Stored Tare Value

Used to remove a stored tare value.

1. Remove all weight from the scale to obtain gross zero.
2. When  displays, press  (in OIML mode, press ). **Gross** displays.

Alternatively, remove a stored tare value using a **Keyed Tare** of zero.

### Keyed Tare



Used to add a keyed tare.

1. Enter a value from the numeric keypad or an attached keyboard.
2. Press . **Net** displays indicating the keyed tare weight is in the system.

## 1.9.7 Print Ticket

Pressing  sends the gross or net ticket format to the configured serial, USB or Ethernet port associated with its ticket format. When displaying the accumulator, it prints the accumulator format.

To print tickets using auxiliary formats (1–20), enter the format number with the numeric keypad.

1. Wait for  to display.
2. Enter an auxiliary format (1–20).
3. Press  to send data to the serial port.

## 1.9.8 Accumulator Functions

### Printing While in Accumulate

If the accumulator is enabled, weight is accumulated whenever a print operation is performed by:

- Pressing 
- Activating a digital input print
- Receiving a KPRINT serial command
- iRite calling the **PRINT ( )** function
- Activating the accumulator setpoint

The scale must return to zero before the next accumulation

### Display or Clear the Accumulator

- A softkey can be programmed for each function
- A **Display or Clear Accumulator Digital Input** can be activated
- A serial command can be sent

### Print the Accumulated Value

To print the accumulated value, press  while displaying the accumulator.

## 1.10 Alibi Storage

Alibi storage is a database of past transactions listed by date. This allows previous print transactions to be recalled and reprinted. Alibi storage is enabled using the **Features** menu in configuration mode. Print transactions can be recalled by assigning a softkey to Alibi.



1. Press the **Alibi** softkey.
2. Use the arrows to scroll to the record required.
3. Press **Reprint** to print the record.
4. Repeat steps 2-3 until all records required have been printed.
5. Press **Done**.

## 1.11 Peak Hold

Peak hold is used to determine, display and print the greatest weight reading during a weighing cycle.

There are three types of peak hold: automatic, manual and bi-directional.

To use the peak hold function:

1. Tare the scale to put it into net mode.
2. Increase the weight. As the weight increases, the indicator captures and holds the highest weight recorded.
3. Press  to see the real live weight (as opposed to the peak hold weight).
4. Press  or  to clear the peak hold (unless it is set to automatic mode in which case it clears automatically).

## 1.12 Rate Of Change

Rate of change is expressed in weight per time unit (weight/time).

*Example: lb/sec*

To view the rate of change:

1. Press the **Display Rate of Change** softkey.
2. To return to the live weight, press **Display Rate of Change** again.

## 1.13 Setpoint Entry

Setpoints can be configured to perform actions or functions based on specified parameter conditions. For more information on setpoints, see [Section 10.0 on page 103](#).

To change the setpoint value:

1. Press **Setup**.
2. Press the **Setpoint Values** key in the Main menu or from the black drop down list, or press the **Setpoint** softkey.
3. Press **Setpoint 1** to select the setpoint (1–100) for which the target value needs to be changed.
4. Press the red number of the setpoint in the table. It may be necessary to use the arrows at the bottom of the screen scroll through the setpoints.
5. Press **Value** to bring up the numeric entry keypad.
6. Enter the new target value and press **Done**.
7. Press **Settings** to toggle between enabled and disabled.
8. Press **Done** and **Save and Exit**.

## 1.14 Softkey Operations

Softkeys are configured to provide additional operator functions. Softkeys are displayed as digital buttons at the bottom of the touch screen display area, see [Figure 1-1 on page 11](#).

Softkey	Description
Blank	No softkey available
User Defined 1–10	Up to 10 softkeys can be created using one of the user defined options (22 characters or less available)
Time/Date	Displays current time and date; allows time and date change
Display Tare	Displays tare value in the entry prompt
Display Accumulator	Displays accumulator value, if enabled, for the current scale
Display Rate of Change	Displays rate-of-change value, if enabled, for the current scale
Setpoint	Displays a menu of configured setpoints; allows display and change of some setpoint parameters
Batch Start	Starts a batch from the current step if a Batch Run digital input is active or not defined; if a Batch Run digital input is defined and inactive, Batch Start resets the batch to the first step
Batch Stop	Stops an active batch and turns off all associated digital outputs; requires a Batch Start to resume processing
Batch Pause	Pauses an active batch and turns off all digital outputs except those associated with Concurrent and Timer setpoints; processing is suspended until the indicator receives a Batch Start signal; pressing the BATSTRT digital input, BATSTART serial command, Batch Start softkey or the StartBatch function (iRite) resumes the batch and re-energizes all digital outputs turned off by the Batch Pause
Batch Reset	Stops an active batch and resets the current step to the first batch step; all digital outputs associated with batch setpoints are deactivated; if a batch is stopped or paused, Batch Reset resets the current step to the first step
Select Scale	Enter the scale number (use numeric keypad) to be displayed for multi-scale applications, followed by the select scale softkey
Diagnostics	Opens the iQUBE <sup>2</sup> diagnostics screen
Alibi	Allows previous print transactions to be recalled and reprinted
Contrast	Adjusts the screen backlight intensity
Test	Not available in version 1.00
Stop	Sends AuxFmt13 out its configured port to display a red light on a LaserLight
Go	Sends AuxFmt12 out its configured port to display a green light on a LaserLight
Off	Sends AuxFmt14 out its configured port to turn a LaserLight red/green light off
Display Unit ID	Displays the Unit ID in the lower left corner of the screen
Zero	Zeros the indicator
Gross/Net	Toggles between gross and net modes
Tare	Tare the scale by using the on screen numeric keypad
Keyed Tare	Tare the scale by using the on screen numeric keypad
Units	Toggles between primary, secondary and tertiary units
Print	Prints the configured print format
Aux Print	Auxiliary printing by entering the Auxiliary Format number (1–20)
Screen	Display a different screen by entering a value (1–99) and pressing the Screen softkey
Database	Accesses the import and export database feature from the weigh mode

Table 1-6. Configurable Softkeys

## 1.15 Error Conditions

Table 1-7 displays possible error codes and their remedies.

Symptom	Cause	Remedy
^^^^^^ in weight display	Over-range scale condition	Check scale for out-of-range conditions; Check all scale inputs for positive weight values
vvvvvv in weight display	Under-range scale condition	
- - - - - in weight display	Invalid Weight	

Table 1-7. Error conditions

## 2.0 Installation

This section describes procedures for connecting power, load cells, digital I/O and data communications cables to the 1280 indicator. Instructions for replacement of the circuit boards are also included, along with assembly drawings and replacement parts lists for the service technician.



**Always use Caution when handling electrostatic sensitive devices (ESD).**



**CAUTION:** Electrostatic sensitive device (ESD), observe handling precautions to prevent shock or damage caused from electrostatic discharge.



**WARNING:** Failure to heed the following statements could result in serious injury or death.

- Use a wrist strap for protection and damage to components from electrostatic discharge (ESD) when working inside the indicator enclosure.
- Procedures requiring work inside the indicator must be performed by qualified service personnel only.
- In the wall and universal mounts, the supply cord serves as the power disconnect. The power receptacle to the indicator must be accessible for these models.
- Disconnect all power supply cords before servicing.
- Input power source for the 1280-4D must be PS2/LPS (Class 2).

### 2.1 Unpacking

Immediately after unpacking, visually inspect the 1280 to ensure all components are included and undamaged. The shipping carton should contain the controller, display, parts kit, any options ordered with the unit and the appropriate manuals. If any parts were damaged in shipment, notify Rice Lake Weighing Systems and the shipper immediately.

### 2.2 Mounting/Assembly

There are three enclosure styles – universal mount, wall mount and panel mount.

#### 2.2.1 Torque Values

It is important to maintain the following torques during installation and the replacement of hardware to ensure IP ratings are maintained.

Hardware	Where Used	Torque (in-lb)
Screw, Machine #6-32 UNC	Seal Wire Anchor	20
Screw, Fillister #10-32 UNF	Seal Wire Anchor	20
Screw, 1/4-20 UNC	Front Panel	22
Antenna Jack, 1/4-Extra Fine Thd	Antenna Jack	20
Breather Vent, M12 x 1.5	Breather Vent	10
Samtec Plug, Large Dia Thd	Bulkhead Connection	12
PG9 Cord Grip Nut	Metal Cord Grips	55
PG13.5 Cord Grip Nut	Metal Cord Grips	55
PG9 Cord Grip Cap	Metal Cord Cap	37
PG13.5 Cord Grip Cap	Metal Cord Cap	37
PG9 Plastic Cord Grip Nut	Power Cord	33
PG9 Plastic Cord Grip Cap	Power Cord	22

Table 2-1. Torque Values



**IMPORTANT:** Hardware must be torqued to the specified values to maintain IP rating. Torque values are both recommended and maximum. Both over and under torquing can compromise the IP rating.

## 2.2.2 Universal Mount Enclosure with Tilt Stand

### Remove Shipping Bracket

The universal mount is shipped with a shipping bracket inside the enclosure to stabilize it during shipping.

1. Loosen the four screws securing the front door.

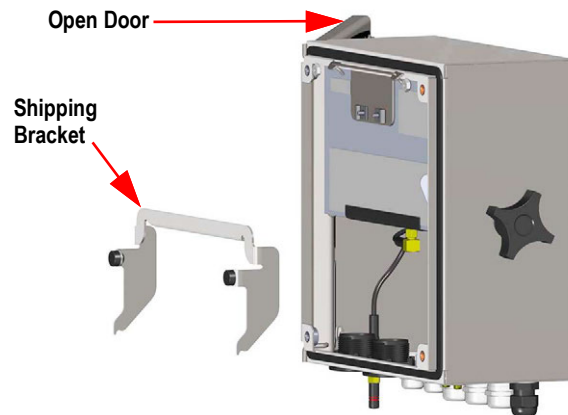

Figure 2-1. Remove Shipping Bracket

2. Pull the door and fully extend the hinge to swing the door open.
3. Remove the loose shipping bracket from the enclosure.



**IMPORTANT:** Shipping bracket must be removed to maintain IP ratings. Retain shipping bracket for future shipping needs.

### Controller Disassembly



**NOTE:** The controller can be tilted up with the locking tab or it can be completely removed from the enclosure by removing the retaining wire bail.

1. Remove the large fillister screw in the back of the indicator to tilt or remove the controller. The seal must be broken for this purpose.



Figure 2-2. Open Cover

2. Loosen the four screws securing the front door.
3. Pull the door and fully extend the hinge to swing the door open.

4. Pull the locking tab to the left to release the controller assembly.
5. Remove the wires connected to the controller assembly.
6. Remove the retaining wire bail connected to the controller assembly. This only needs to be removed if the controller is being removed from the enclosure.
7. Lift controller assembly from the enclosure.

Reverse this procedure for reassembly. Upon reassembly, ensure display and keyboard wires are properly connected.



**NOTE:** To close the door to the universal enclosure, push the bail in and down so that it does not get caught on the controller assembly.

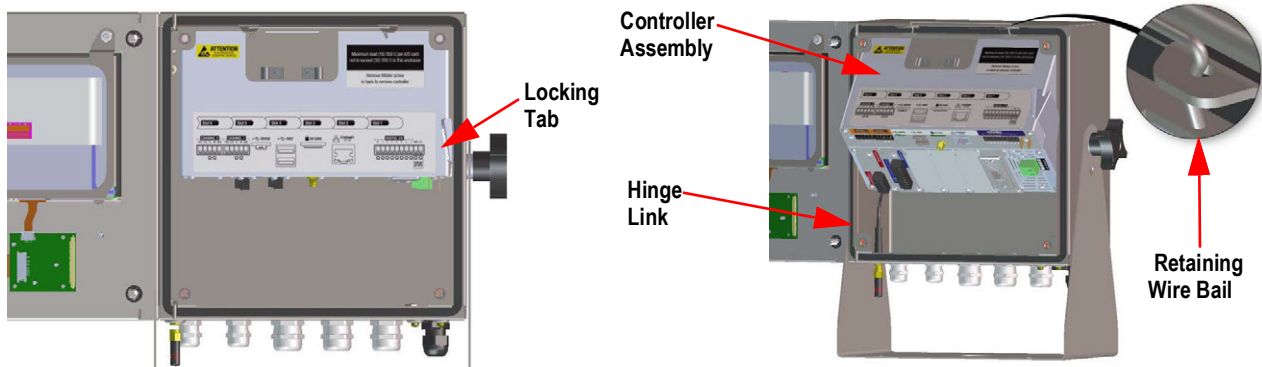

Figure 2-3. Remove CPU Assembly- Universal

### Universal Mount Dimensions

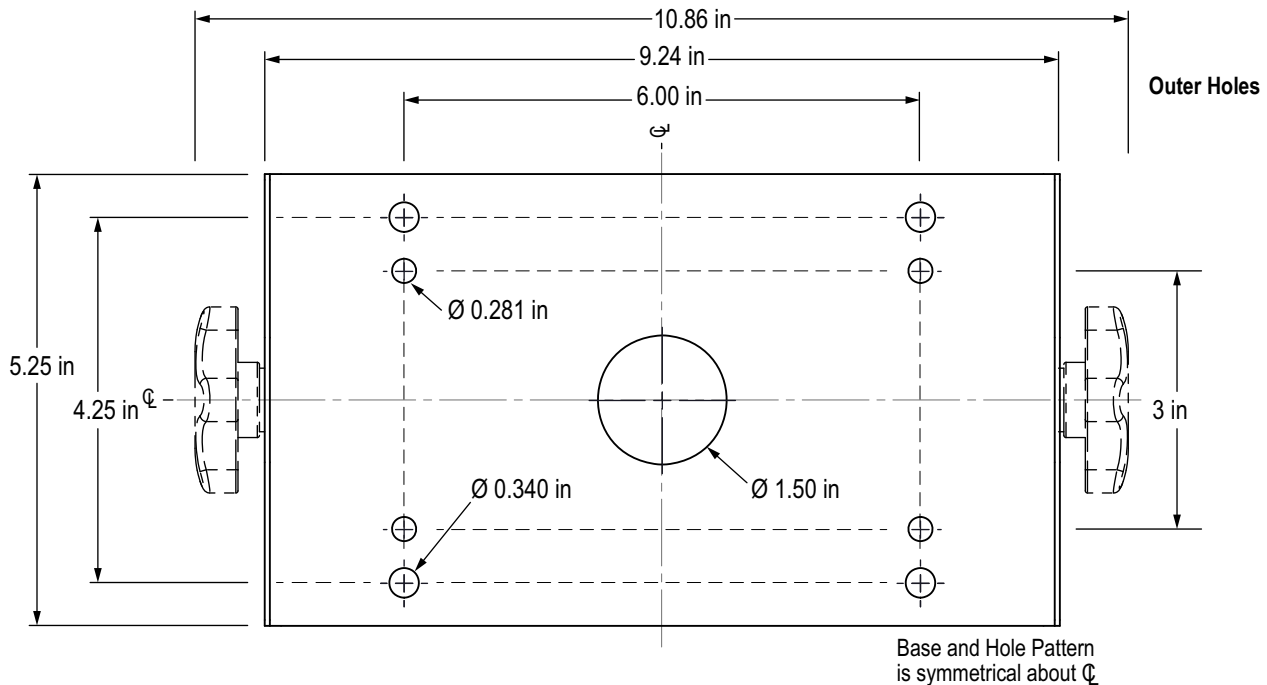

Figure 2-4. Universal Tilt Stand Hole Pattern Dimensions

The outer set of larger holes seat rubber feet or mount the stand to solid surfaces. The inner set of smaller holes mount the universal mount to an optional indicator stand (PN 126384 or PN 19352)



**IMPORTANT:** This illustration is not to scale and is for illustration purposes only. Use the dimensions to mark the holes for the universal mount, or use the bottom of the tilt stand as a template. Do not use this figure as a template.



## Mount to Surface

The universal mount is shipped with a tilt stand and can be mounted on a wall, tabletop or any flat surface.

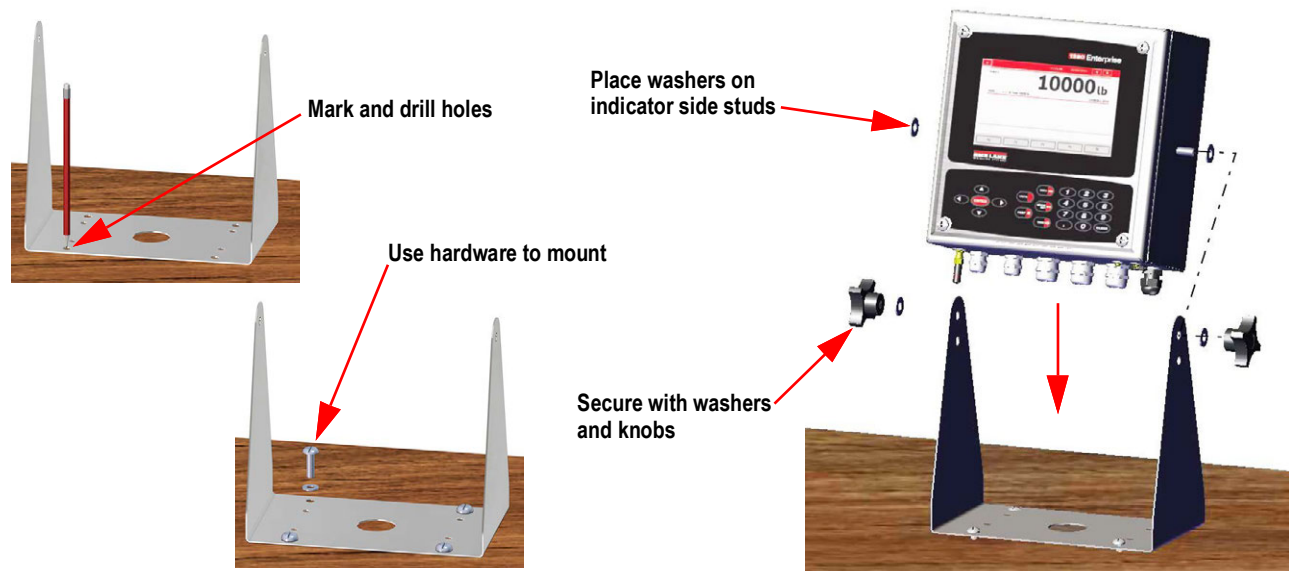

Figure 2-5. Mount Universal Enclosure

1. Using the tilt stand as a template, mark the screw locations. See [Figure 2-4 on page 24](#) for dimensions.



**NOTE:** The universal enclosure can mount to the same location where a 920i universal enclosure was mounted; the screw locations for the tilt stand are the same.

2. Drill holes for the screws.
3. Mount the tilt stand using the appropriate hardware (not included).
4. Place one washer on each side stud of the indicator enclosure.
5. Place the indicator side studs into the holes on the arms of the tilt stand.
6. Secure with remaining washers and hand knobs from the hardware kit.
7. Wire the indicator. See [Section 2.3 on page 35](#).

## Mount to Stand

The universal mount tilt stand can be attached to an optional indicator stand (PN 126384 or PN 19352)

### Sealing the Setup Switch

In certain Legal for Trade applications, it may be necessary to seal the indicator to restrict access from the setup switch. Use the following instructions to seal the universal enclosure.



**IMPORTANT:** The audit trail jumper (JP1) needs to be disabled, in the off (right) position, in order to seal the setup switch with a lead seal wire. Access is not prevented simply by sealing the setup switch.

1. Move the audit trail jumper (JP1) from the On position (by default) to the Off position (right most jumper position), see [Section 2.6 on page 44](#) for instructions on how to remove the CPU board (which is necessary to disable the audit trail jumper). This restricts access from the configuration menu through the front panel.
2. If not previously installed, install the large fillister screw in the back of the indicator.
3. Wrap the lead wire seal through the large fillister screw and the two smaller fillister screws in order to seal the indicator. This restricts access to the setup switch.

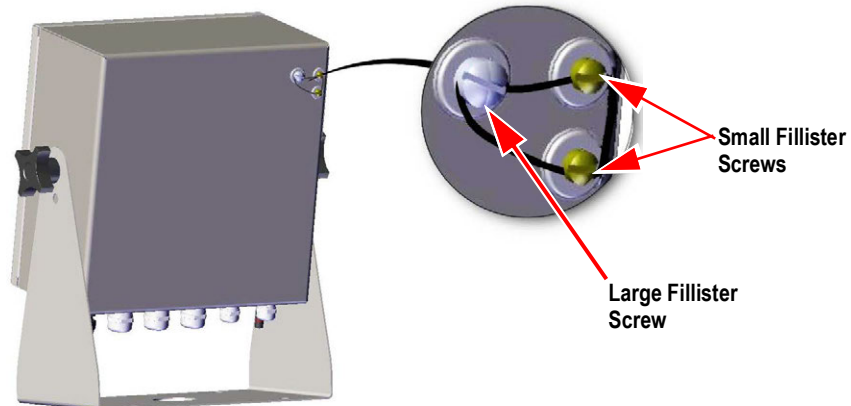

Figure 2-6. Seal the Setup Switch (Universal Mount)

### Sealing the Front Door

In Legal for Trade applications, it is necessary to seal the indicator to restrict access to the internal hardware of the indicator. To seal the universal enclosure front door, wrap a lead wire seal through the large bottom right screw securing the front door and the two small fillister screws on the bottom of the enclosure. Alternatively, the A/D scale card includes fillister screws and a bracket that prevent the load cell cable from being disconnected.

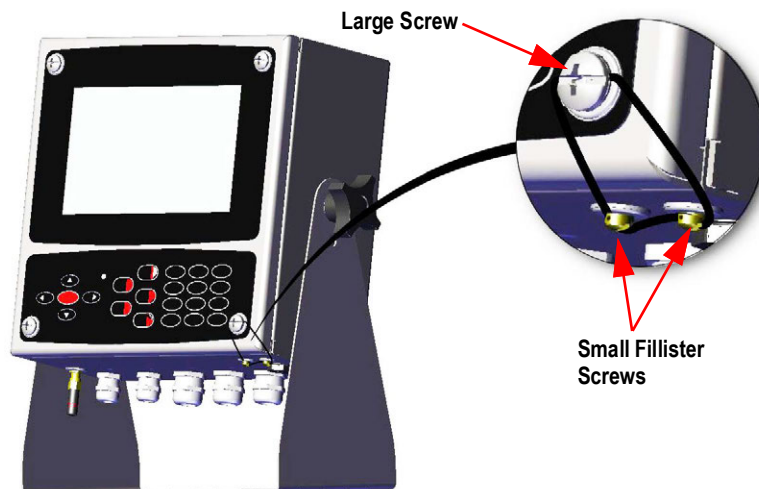

Figure 2-7. Seal the Front Door (Universal Mount)

### 2.2.3 Wall Mount Enclosure

- Using the wall mount as a template, mark the screw locations.



**NOTE:** The wall enclosure can mount to the same location where a 920i was mounted; the screw locations are the same.

- Drill holes for the screws.
- Mount using the appropriate hardware (not included).

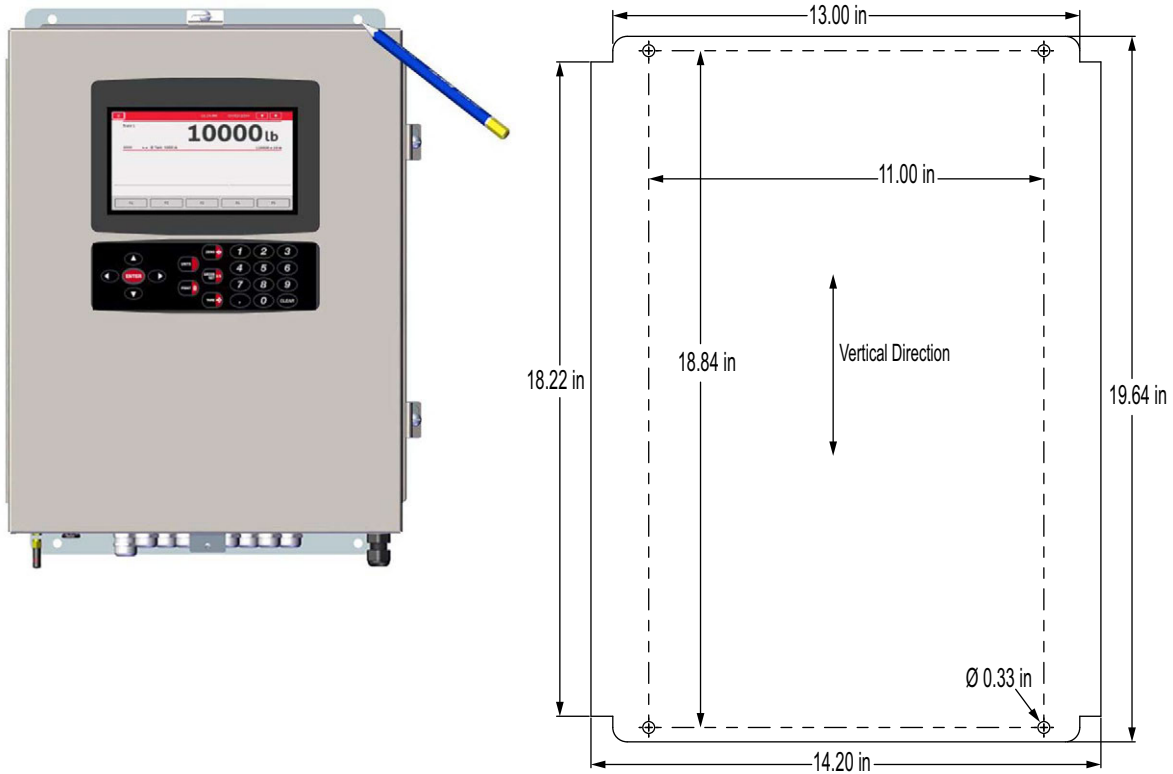

Figure 2-8. Wall Mount



**IMPORTANT:** This illustration is not to scale. It is for illustration purposes only. Use the dimensions to mark the holes for the wall mount. Do not use as a template.

#### Remove Shipping Bracket

- Loosen the four screws on the front door.
- Swing the door open.
- Remove the four screws securing the bracket in place.
- Remove bracket from the enclosure.

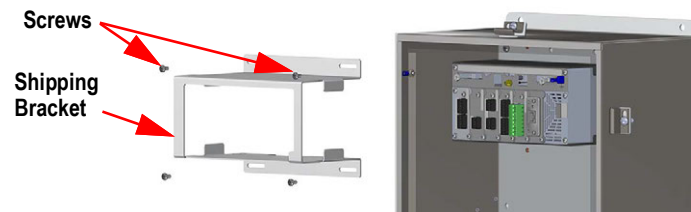

Figure 2-9. Remove Shipping Bracket

## Controller Disassembly

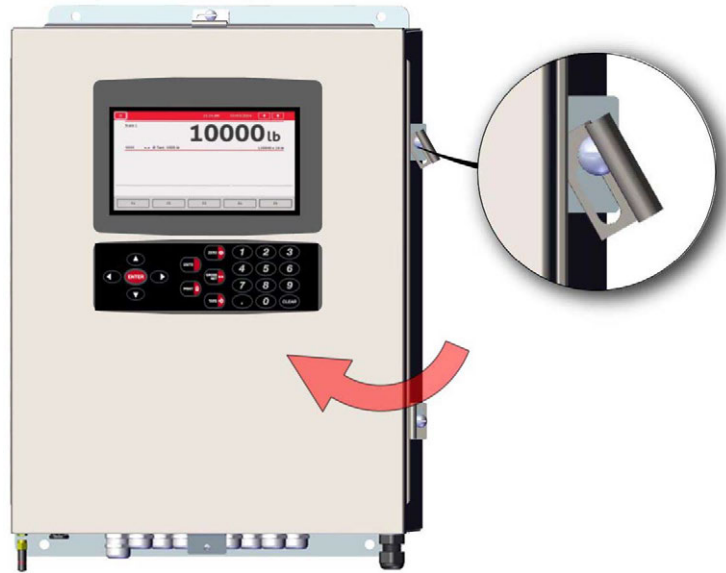

Figure 2-10. Open Door

1. Loosen the four screws on the front door.
2. Swing the door open.
3. Remove the wires connected to the controller assembly.

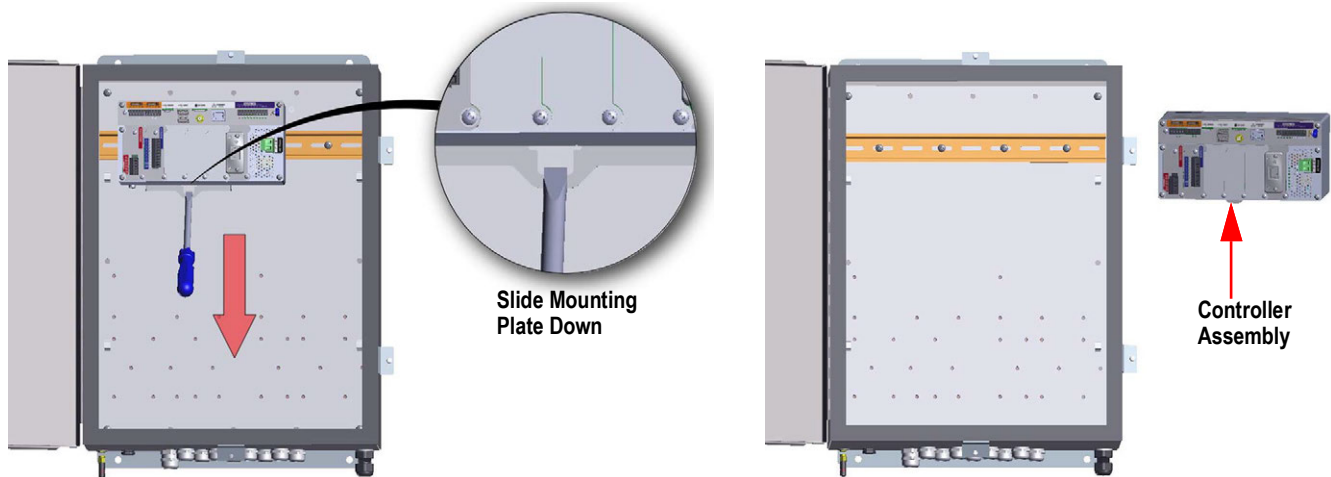

Figure 2-11. Remove Controller Assembly - Wall Mount

4. While supporting the controller assembly, use a screwdriver to slide the mounting plate down.
5. Lift the controller assembly up to remove it from the DIN rail and pull it out of the enclosure.

Reverse this procedure for controller assembly installation.



**NOTE:** When closing the door, tighten screws to 15 in-lb to ensure the enclosure is securely sealed.

## Sealing the Setup Switch

In Legal for Trade applications, it is necessary to seal the indicator to restrict access to the setup switch. Use the following instructions to seal the wall mount enclosure.

**IMPORTANT:** The audit trail jumper (JP1) needs to be disabled, in the off (right) position, in order to seal the setup switch with a lead seal wire. Access is not prevented simply by sealing the setup switch.

1. Move the audit trail jumper (JP1) from the On position (by default) to the off position (right most jumper position), see [Section 2.6 on page 44](#) for instructions on how to remove the CPU board (which is necessary to disable the audit trail jumper). This will restrict access from the configuration menu through the front panel.
2. Wrap the lead wire seal through the large fillister screw and the bottom tab of the DIN rail clip to restrict access to the setup switch.

Enclosure hidden for illustration purposes, controller assembly does not need to be removed from the enclosure to seal the setup switch.

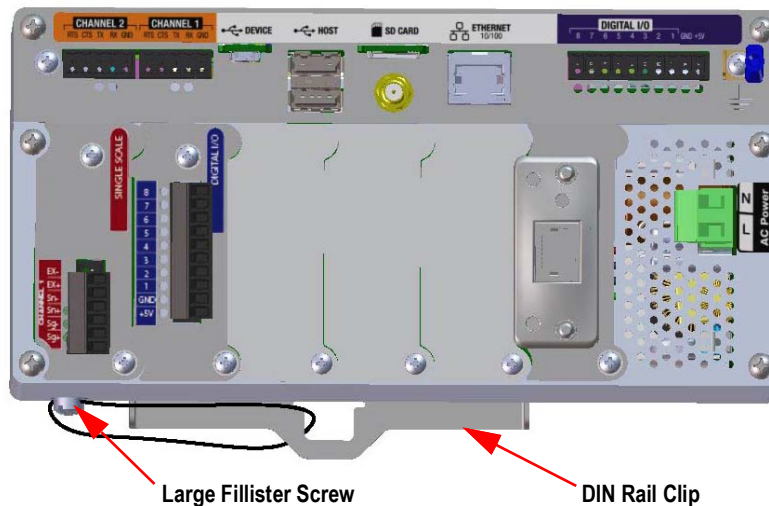

Figure 2-12. Seal the Setup Switch

## Sealing the Front Door

In Legal for Trade applications, it is necessary to seal the indicator to restrict access to the internal hardware of the indicator. To seal the wall mount enclosure front door, wrap the lead wire seal through the large screw securing the front door and the hole in the edge of the door enclosure. Alternatively, the A/D scale card includes fillister screws and a bracket that prevent the load cell cable from being disconnected.

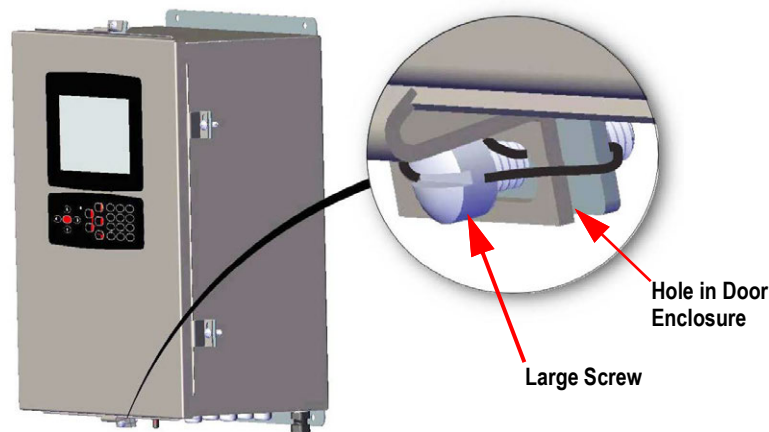

Figure 2-13. Seal the Front Door

## 2.2.4 Panel Mount Installation

The panel mount ships partially assembled. The display assembly must be removed from the DIN rail bracket for installation.

**IMPORTANT:** Models 1280-4A and 1280-4D are intended for installation in a restricted access location.

1. Remove the two screws securing the DIN rail bracket to the display assembly.
2. Use the DIN rail bracket as a template to mark the hole locations on the existing panel.
3. Drill holes at the marked locations. See [DIN Rail Bracket Dimensions](#) below for exact measurements.
4. Place the display assembly and the DIN rail bracket on either side of the panel. Ensure that the DIN rail is horizontal.

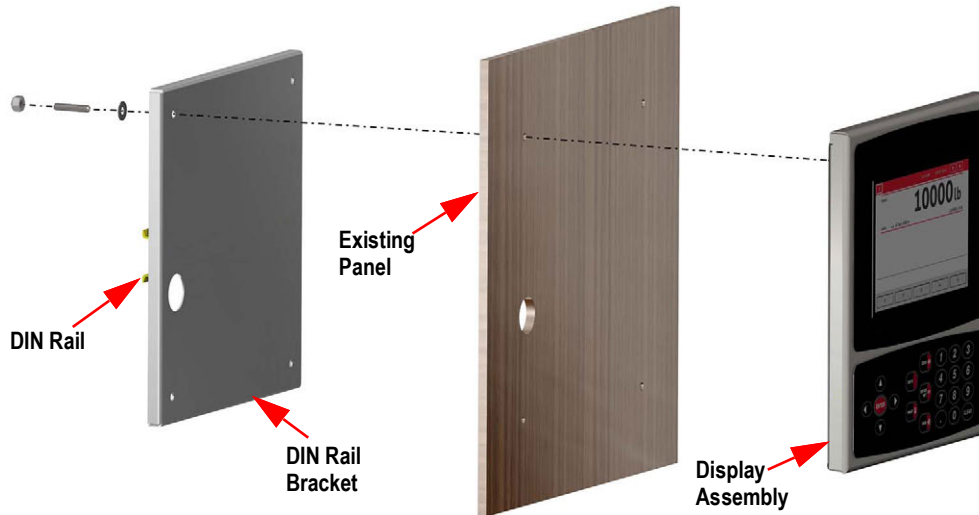

Figure 2-14. Panel Mount Installation

5. Use studs, nuts and washers to secure the display assembly to the DIN rail bracket.

### DIN Rail Bracket Dimensions

**IMPORTANT:** The dimension illustrations are not to scale, they are for reference only. Use the dimensions to mark the holes for the panel mount, or use the DIN rail bracket as a template. Do not use figures as templates.

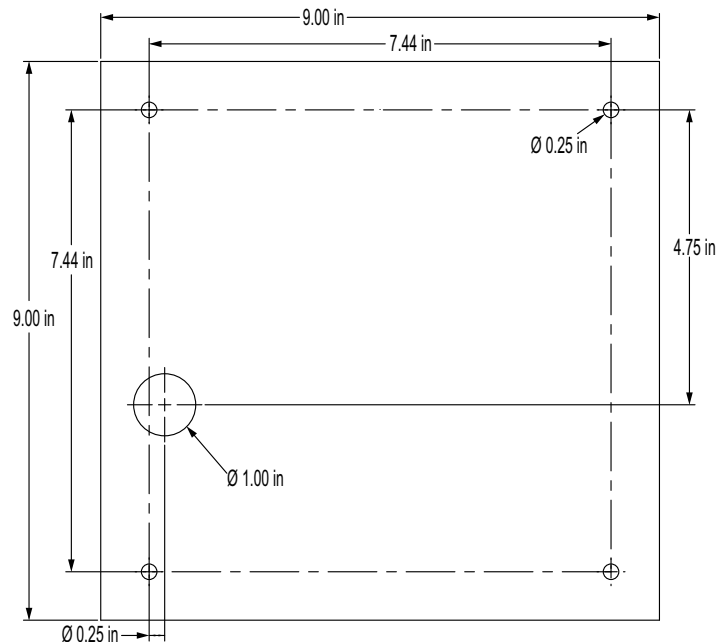

Figure 2-15. 7 Inch Panel Mount (with Keypad) Dimensions

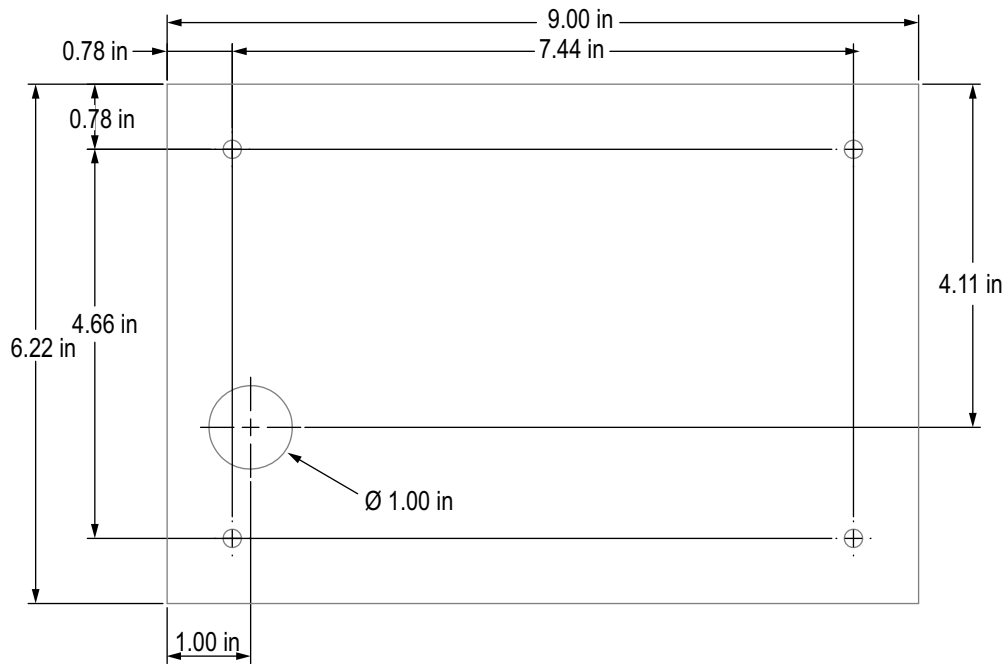

Figure 2-16. 7 in Touch-Only Panel Mount Dimensions

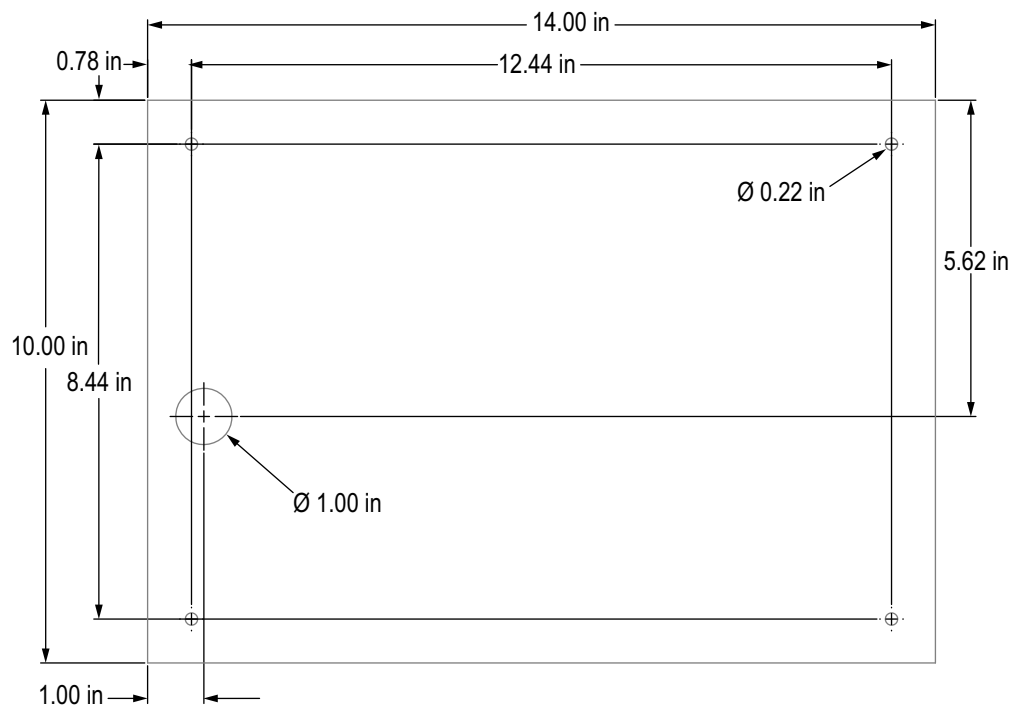

Figure 2-17. 12 in Touch-Only Panel Mount Dimensions

### Install Grounding Bus Bar

The grounding bus bar is installed on the controller assembly for grounding purposes on the panel mount.

1. Remove the four corner screws from the controller assembly.
2. Align the bus bar to the screw holes and secure by reinstalling the screws.

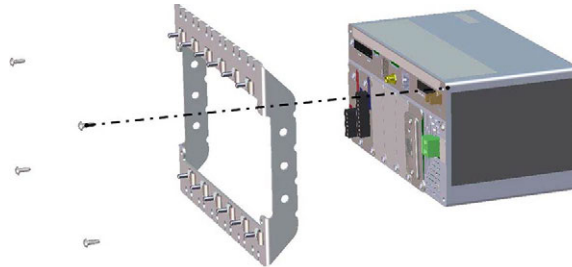

Figure 2-18. Grounding Bus Bar Installation

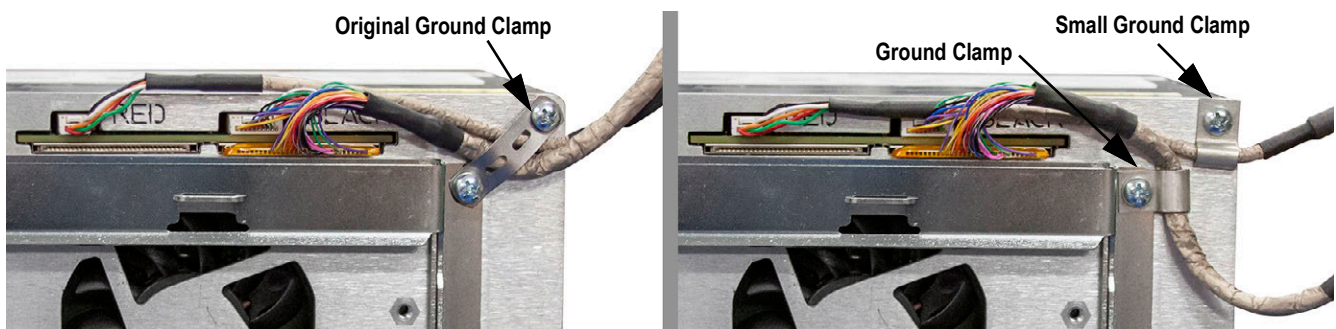

Figure 2-19. Controller Box Shield Grounding



**NOTE:** Reconnect cables to the controller which were disconnect before reinstalling it back into the enclosure.

### Install Controller Assembly

The controller assembly can be mounted to a standard DIN rail.

1. Hook the mounting bracket on the back of the controller assembly onto the DIN rail.



**NOTE:** The controller assembly can be installed up to 30 in from the display assembly of the panel mount.

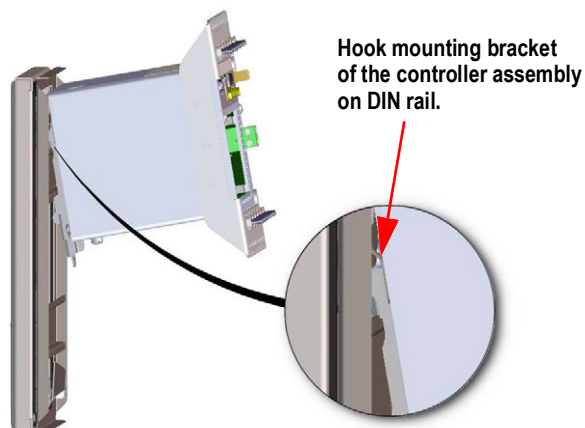

Figure 2-20. Hook Mounting Plate on DIN Rail

2. Push controller assembly against the DIN rail in order to engage the spring clip of the mounting bracket. The controller assembly locks onto the DIN rail.
3. Connect wiring. See [Section 2.3 on page 35](#).



## Removing Controller Assembly

1. Disconnect wiring.
2. Supporting the controller assembly and use a screwdriver to slide the mounting plate down.
3. Unhook the controller assembly from the DIN rail bracket.
4. Carefully remove the controller assembly from the DIN rail bracket and release the mounting plate.

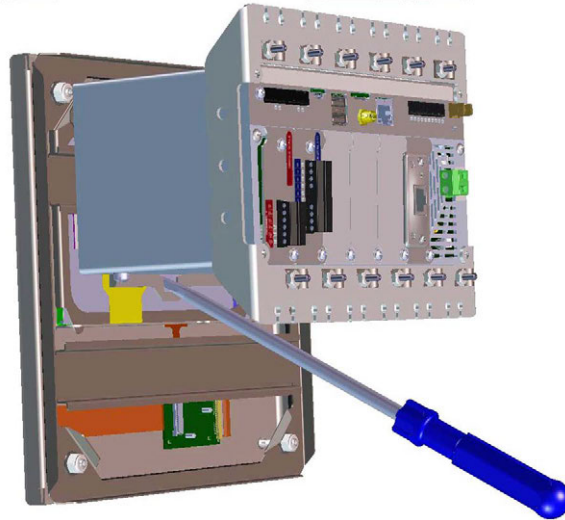

Figure 2-21. Remove Controller Assembly

## Seal Setup Switch

In Legal for Trade applications, it is necessary to seal the indicator to restrict access to the setup switch. Use the following instructions to seal the panel mount enclosure.

**!** **IMPORTANT:** The audit trail jumper (JP1) needs to be disabled, in the off (right) position, in order to seal the setup switch with a lead seal wire. Access is not prevented simply by sealing the setup switch.

Wrap the lead wire seal through the large fillister screw and through the bottom tab of the DIN rail clip to restrict access to the setup switch. Alternatively, the A/D scale card includes fillister screws and a bracket that prevent the load cell cable from being disconnected.

Enclosure and grounding bus bar hidden for illustration purposes. Controller Assembly does not need to be removed from the enclosure to seal the setup switch and the grounding bus bar can remain attached, if installed.

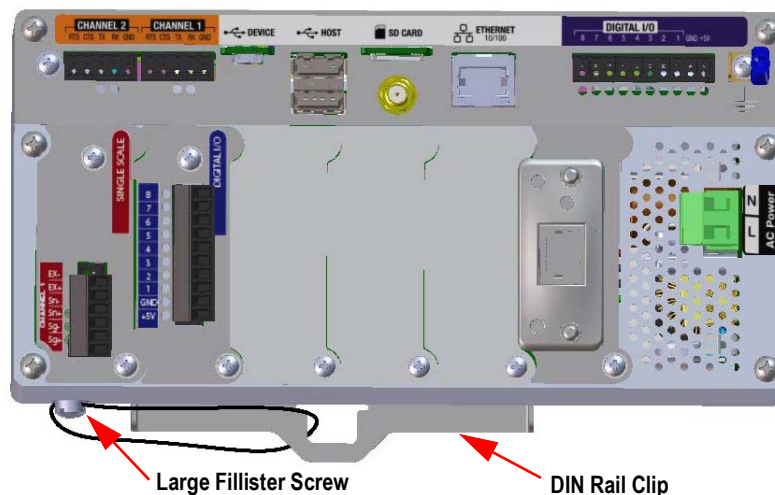

Figure 2-22. Seal the Setup Switch (Panel Mount Enclosure)

Use the following instructions to install option cards. There are two SPI communication buses for the six option card slots: one for slots 1, 2 and 3 and one for slots 4, 5 and 6. Communication is faster with less traffic on an SPI bus. For optimal performance, populate slots 1 and 4 first in order to keep cards on their own SPI bus.

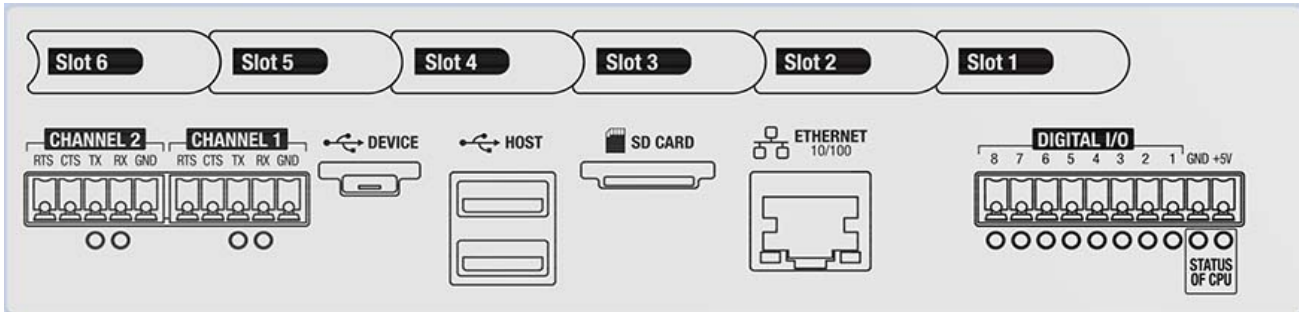

Figure 2-23. Label on Top of Controller Assembly

**NOTE:** Figure 2-24 illustrates label location.

**WARNING:** Always disconnect power before opening the indicator.

**IMPORTANT:** Use a wrist strap to ground yourself and protect components from electrostatic discharge (ESD) when working inside the indicator enclosure.

\* Procedures requiring work inside the indicator must be performed by qualified service personnel only.

\* In the wall and universal mounts, the supply cord serves as the power disconnect. The power receptacle to the indicator must be accessible for these models.

**NOTE:** It is recommended to remove the controller assembly from the universal enclosure for easier installation of option cards. Recommended option card connection torque rating for most options cards is 2-4 in-lb (0.22-0.45 N-m).

Recommended connection torque rating for the relay card is 5 in-lb (0.56 N-m)

16-28 AWG (all other connection specifications associated with option cards can be found in Section 18.0 on page 178)

1. Remove the hardware securing the slot cover plate.
2. Remove the slot cover plate.
3. Slide the option card into place.
4. Secure the card using the hardware which secure the slot cover plate.
5. Connect cables.

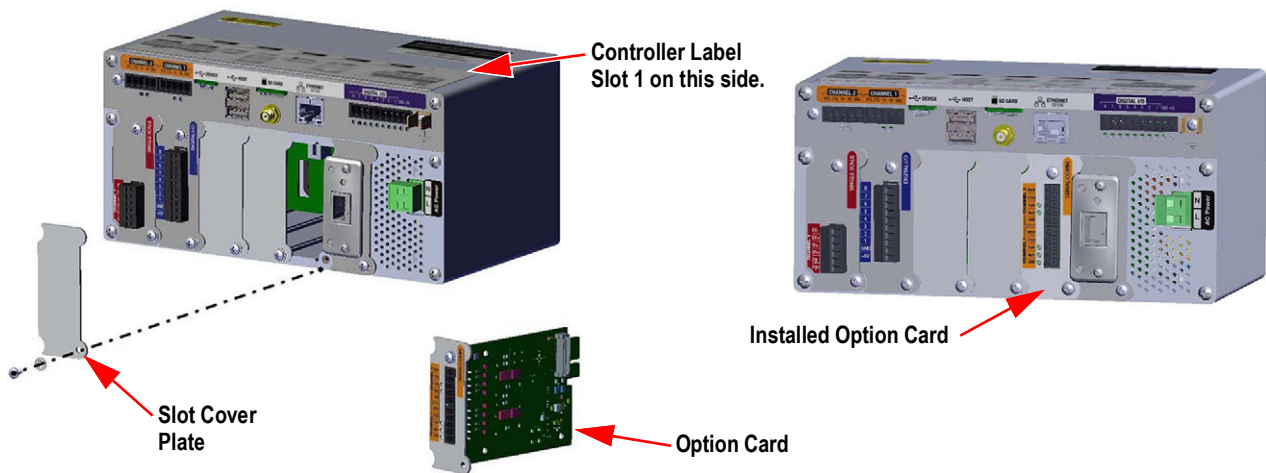

Figure 2-24. Option Card Installation

### Seal the Scale Card

Once an option card has been put into place and cable connections have been made, a seal can be placed over the card and connections to restrict access and keep them from being removed.

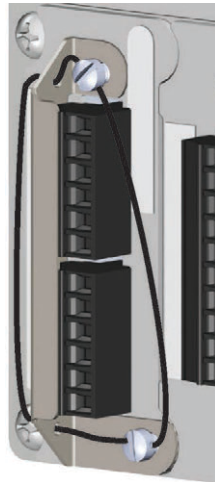

Figure 2-25. Seal Option Card

1. Align the sealing bracket over the connectors on the option card.
2. Secure with two fillister screws.
3. Insert the lead wire seal through the holes in the sealing bracket and the fillister screws.

## 2.3 Cable Connections

The universal and wall enclosures provide cord grips for cabling into the indicator; one for the power cord and the rest are to accommodate interface cables. Install plugs in unused cord grips to prevent moisture from entering the enclosure. Secure wires after cabling is complete to avoid low voltage circuits contacting high voltage circuits.

**IMPORTANT:** If the indicator is on a network that has PoE capable Power Sourcing Equipment (PSE), the PSE must be IEEE 802.af or 802.at compliant. Any PSE that uses passive (always-on) technology will damage the Ethernet port, because it is not designed to act as an Ethernet PoE Powered Device.

### 2.3.1 Water/Dust Tight Cord Grips

The standard cord grip has a black bushing that clamps down on the cable. If cord grip does not run a cable, then add optional post plug to maintain IP seal.

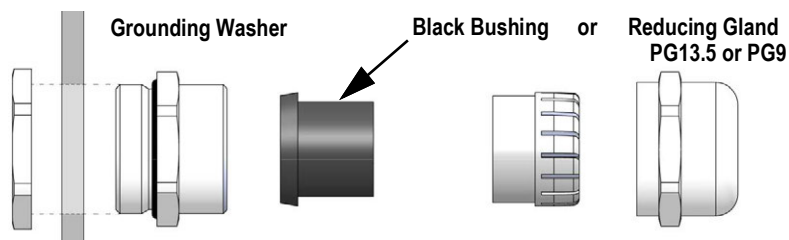

Figure 2-26. Cord Grip with Reducing Gland

Replace the bushing with a reducing gland to accommodate a smaller diameter cable. The reducing gland will allow the cord grip to maintain as much water/dust tightness as possible. Install the reducing gland in the top section of the cord grip in place of the bushing.

Cord Grip (PN)	Cord Grip Diameter	Reducing Gland (PN)	Reducing Gland Diameter
PG13.5 (169876)	0.264-0.472 in (6.7-12 mm)	PG13.5 (195006)	0.157-0.354 in (4-9 mm)
PG9 (169875)	0.157-0.314 in (4-8 mm)	PG9 (195007)	0.118-0.236 in (3-6 mm)

Table 2-2. Cord Grip and Reducing Gland Diameters

### 2.3.2 Shield Grounding Through Cord Grips

To ground cables to the chassis of the universal or wall enclosures, route the cable through one of the metal cord grips. Ensure the exposed shielding makes contact with the tabs of the grounding washer inside the cord grip. Grounding washers are included in the parts kit provided with the indicator.

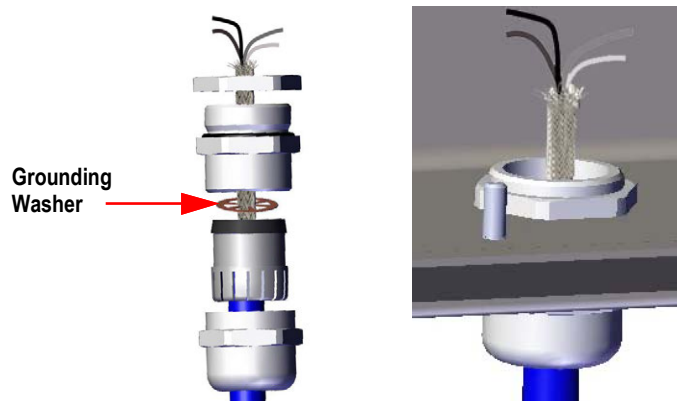

Figure 2-27. Universal and Wall Enclosure Grounding



**IMPORTANT:** All cables routed through the cord grips must be shield grounded against the enclosure. Ensure contact between the exposed shielding and the tabs of the grounding washer. If using foil shields, shield grounding with a clamp and ground stud as in Section 2.3.3 is the most effective grounding method.

### 2.3.3 Shield Grounding with Clamp and Ground Stud

For Universal Mount and Wall Mount indicators:

1. Use hardware provided in the parts kit to install shielding clamps on the grounding studs at the bottom of the enclosure.
2. Route cables through the cord grips and shielding clamps to determine the cable lengths required to reach the appropriate cable connectors.
3. Cut and fold shield wire and foil insulation as in Figure 2-28.
4. Tighten nut to secure.

For Panel Mount indicators, place the shield wire in a grounding clip on the controller assembly to ground load cell and interface cables to the enclosure and secure as above.

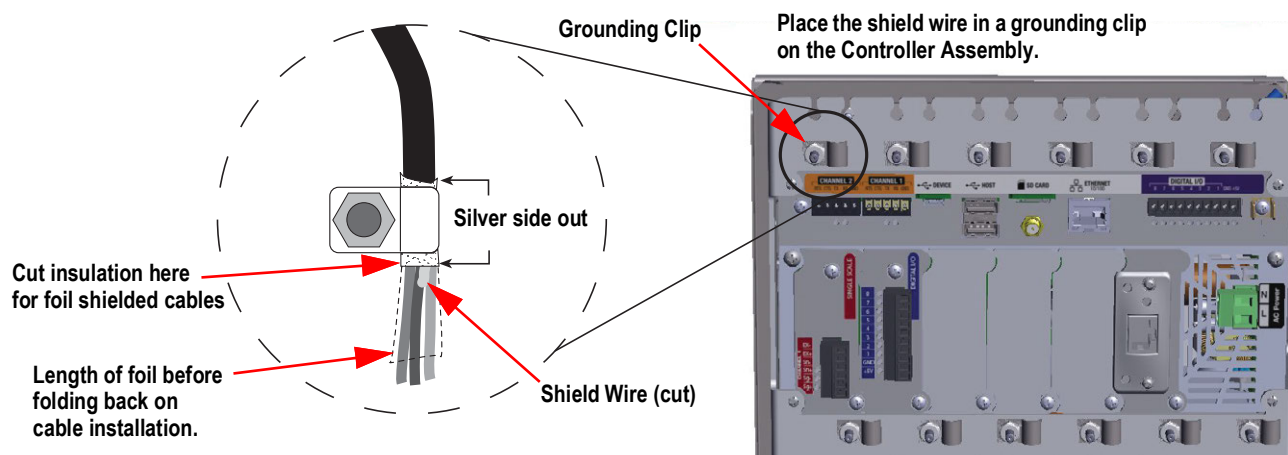

Figure 2-28. 1280 Ground Clamp and Stud Shown on Panel Mount



**NOTE:** The grounding stud from the power supply must be grounded to earth ground per national electrical code (NEC).

### 2.3.4 ESD Grounding for Touch Only Models

The 1280 ESD Grounding Kit (PN 194056) is included with all touch only models. Follow the grounding procedure to properly install the contents of the grounding kit and to avoid any ESD grounding issues.

Part No.	Description	Qty
17780	Ground Strap, 16 in Tinned Copper Braid	1
53075	Clamp, Ground Cable Shield	2
193810	Clamp, Ground Cable Shield Small	2
15139	Washer, Star Lock NO 10 Type A	7
14621	Nut, Keps 6-32NC Hex	1

Table 2-3. 1280 Grounding Kit Parts List

#### Grounding Procedure

1. Ensure the 1280 is powered down and disconnected from power source.
2. Attach ground strap to the backplate of the panel mount using one of the studs and nuts which hold the backplate in place. Order of reassembly must be star washer, ground strap, star washer and lastly the original nut.



**NOTE:** Torque the nuts which secure the backplate to 15 in-lb (1.7 N-m).

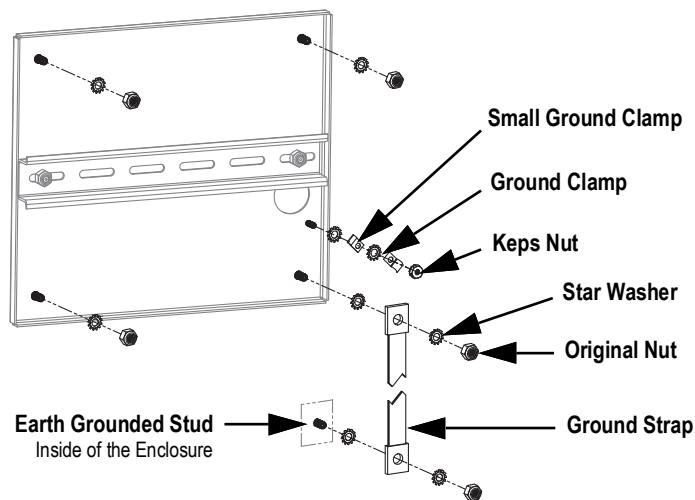

Figure 2-29. Backplate Shield Grounding

3. Secure the other end of the ground strap to an earth grounded stud inside of the enclosure with star washers on either side of the ground strap, see [Figure 2-29](#). Make sure there is an appropriate amount of slack in the grounding strap for opening and closing the enclosure door.
4. Replace the existing washers with star washers for the remaining three studs and nuts which hold the backplate in place.

5. Ground the display cable and the touchscreen cable to the backplate grounding stud using two ground clamps and the Keps nut. PN 193810 ground clamp has a smaller radius and must be used with the touchscreen cable.



**NOTE:** [Figure 2-30](#) is for illustration only and may not represent all panel mount applications. Grounding location and exact stud placement may vary.

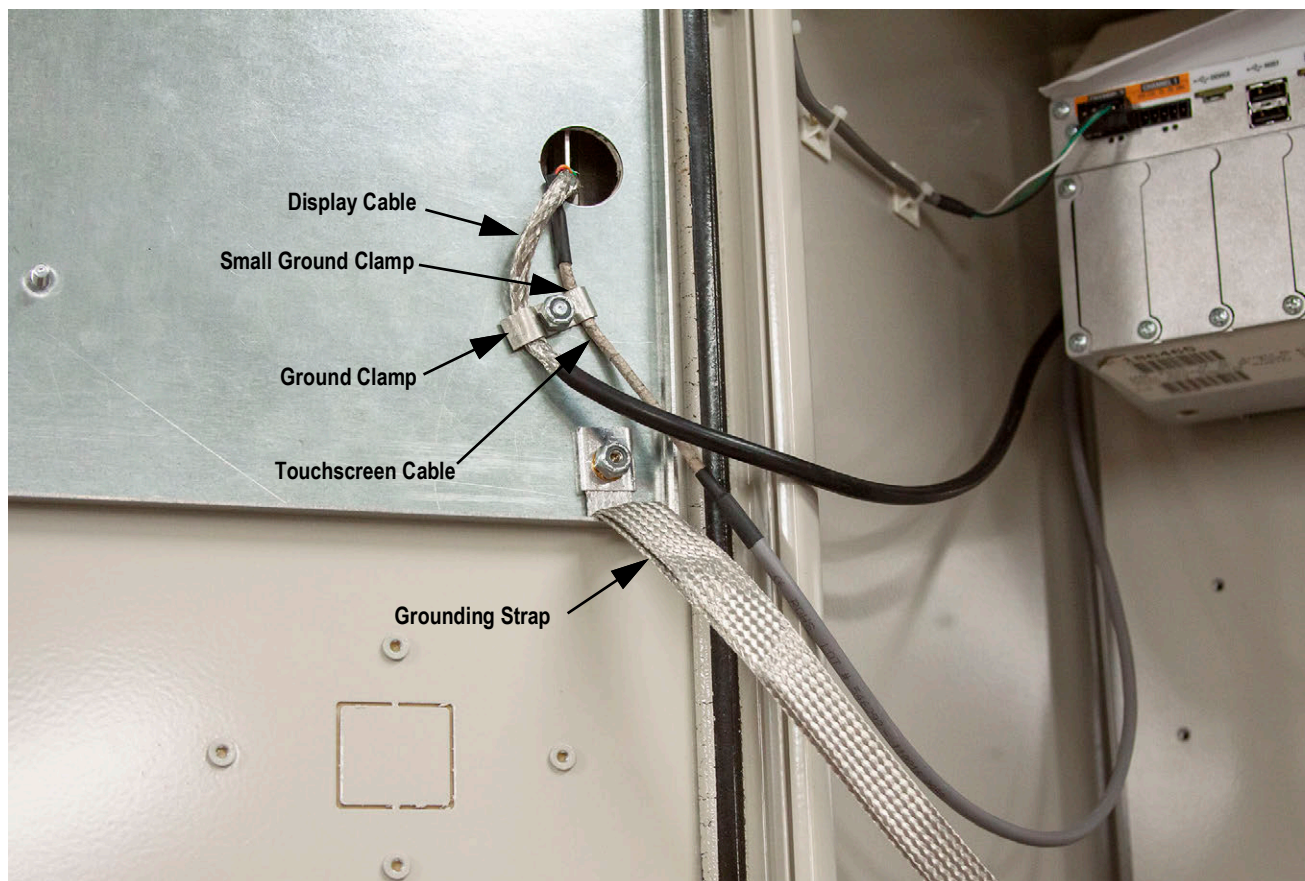

Figure 2-30. Panel Mount Shield Grounding



**NOTE:** Ensure the small ground clamp is installed first then install the ground clamp, see [Figure 2-29](#) on page 37.

6. Remove the 1280 controller box from the enclosure.
7. Remove the original ground clamp used on both the display and touchscreen cables, see [Figure 2-19](#) on page 32.
8. Ground the display cable and the touchscreen cable to the controller box using two ground clamps. PN 193810 ground clamp has a smaller radius and must be used with the touchscreen cable.

### 2.3.5 Load Cells

There are two generations of A/D scale cards. See the below table for identifying characteristics and sources of further information.

Card Generation	Channels	Card PN	Identifying Characteristics	Installation Add. No.	Flash Instructions
First Generation	Single	164085	green circuit board, slide switch, one scale channel	164652	<a href="#">Section 12.3.1 on page 122</a>
	Dual	164683	green circuit board, slide switch, two scale channels	164653	
Second Generation	Single	220026	blue circuit board, push button, one scale channel	220040	<a href="#">Section 12.3.2 on page 123</a>
	Dual	220027	blue circuit board, push button, two scale channels	220039	

Table 2-4. Scale Card Identification Information

Use the following instructions to attach the cable from a load cell or junction box to an installed A/D scale card channel.

1. Route the cables.
2. Wire the load cell cable from the load cell or junction box to the included 6 pin connector.
3. Plug the connector into the appropriate channel of the A/D scale card.



**NOTE:** Wire the load cell cable from the load cell or junction box to connector J1 and/or J2 if using a dual A/D scale card, see [Table 2-5](#) for scale card pin assignments.

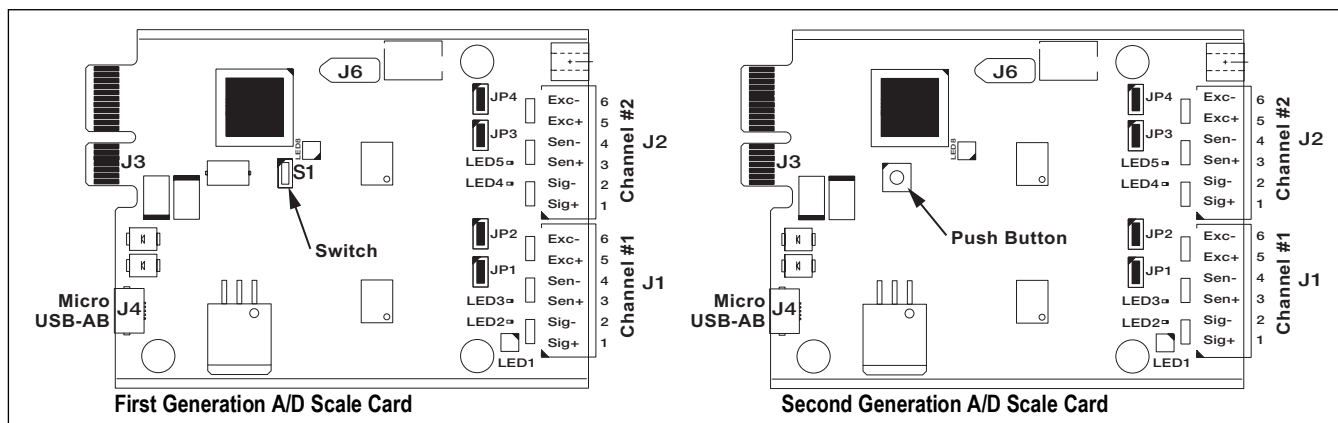

Figure 2-31. Single and Dual A/D Scale Cards



**NOTE:** If using a 6-wire load cell cable (with sense wires), remove jumpers JP1 and JP2 before reinstalling connector J1. On dual-channel A/D scale cards, remove jumpers JP3 and JP4 for connections to J2. For 4-wire installation, leave jumpers JP1 and JP2 on (or JP3 and JP4 depending on the channel).

Scale Card Connector Pin	Function
1	+SIG
2	-SIG
3	+SENSE
4	-SENSE
5	+EXC
6	-EXC

Table 2-5. Scale Card Pin Assignments



**IMPORTANT:** The A/D scale card must be removed from the controller prior to configuring the sense line jumpers.



**NOTE:** The hardware of J2 is not populated on a single A/D scale card.

### 2.3.6 Serial Communications

The two communication ports on the 1280 CPU board support full duplex RS-232, RS-422 or RS-485 communications at up to 115200 bps.

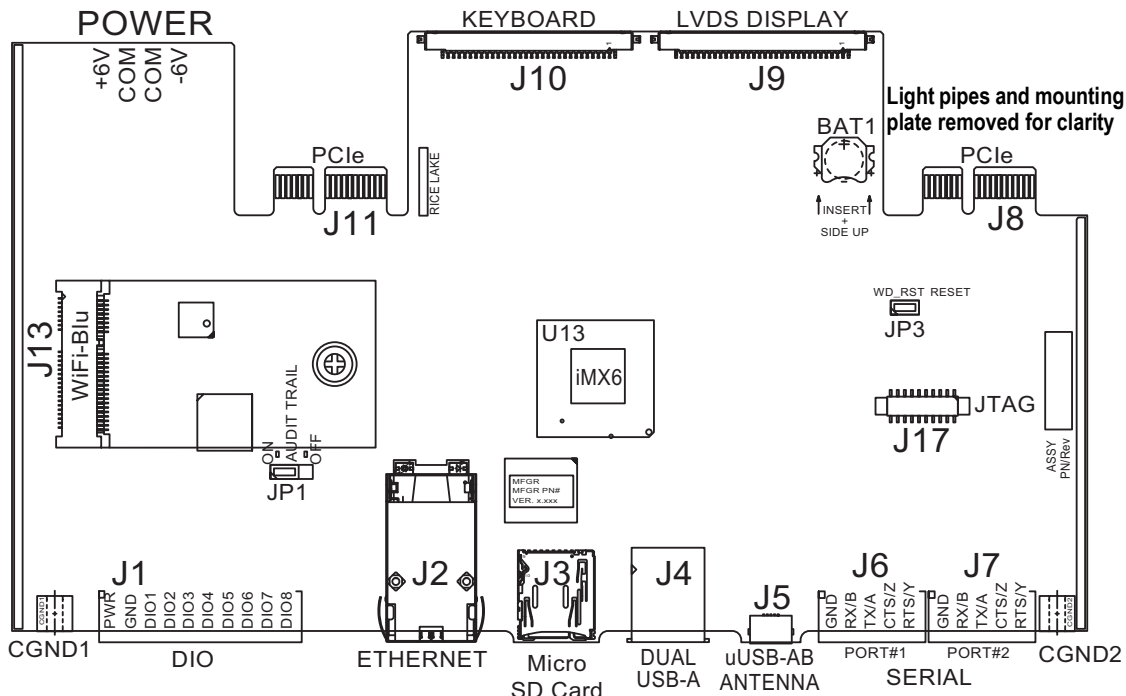

Figure 2-32. CPU Board (Top View)

Use the following instructions to attach serial communication cables.

1. Route cable through the cord grip.
2. Ground the shield wire.
3. Remove the screw holding the face plate.
4. Use clip to ground the front plate.
5. Wire the cables to the connector.
  - See [Table 2-6](#) for the serial protocol desired
6. Plug the wired connector into the intended serial port J6 (Port#1) or J7 (Port#2).

Connector	Pin	Signal	Port
J6	1	GND	1
	2	RS-232 RX/RS-485 B	
	3	RS-232 TX/RS-485 A	
	4	RS-232 CTS/RS-485 Z	
	5	RS-232 RTS/RS-485 Y	
J7	1	GND	2
	2	RS-232 RX/RS-485 B	
	3	RS-232 TX/RS-485 A	
	4	RS-232 CTS/RS-485 Z	
	5	RS-232 RTS/RS-485 Y	

Table 2-6. Serial Port Pin Assignments

Serial ports are configured using the **Serial** menu, see [Section 5.1 on page 74](#) for configuration information.

An optional dual-channel serial communications card, Kit PN 164685, is also available. Each serial option card provides two additional serial ports. Both ports on the option card can support RS-232, RS-422 or RS-485.



**NOTE:** All wiring must conform to the NEC or local ordinances.



### 2.3.7 CPU Digital I/O Wiring

Digital I/O pins are configured using the Digital I/O menu, see [Section 8.0 on page 99](#) for configuration information.

An optional 24 I/O channel card (PN 164684) is also available. Each Digital I/O option card provides an additional 24 configurable I/O bits. Alternatively, a 4-channel Relay card (PN 164689) is also available.

Use the following instructions to wire to the CPU board DIO connector.

1. Route cable through the cord grip, see [Section 2.3.1 on page 35](#).
2. Ground the shield wire, see [Section 2.3.2 on page 36](#).
  - For a wall mount enclosure, route wires to a Relay Rack if equipped (skip [Step 3](#) and [Step 4](#))
3. Remove the screw holding the face plate.
4. Use clip to ground the front plate.
5. Wire the cables to the connector.
6. Plug the connector into J1 on the board.

Connector	Pin	Signal
J1	1	+5 VDC
	2	GND
	3	DIO 1
	4	DIO 2
	5	DIO 3
	6	DIO 4
	7	DIO 5
	8	DIO 6
	9	DIO 7
	10	DIO 8

Table 2-7. CPU Digital I/O Pin Assignments

## 2.4 Wiring Schematics

### 2.4.1 Key Pad Model

For proper wiring of the key pad model, see [Figure 2-33](#).

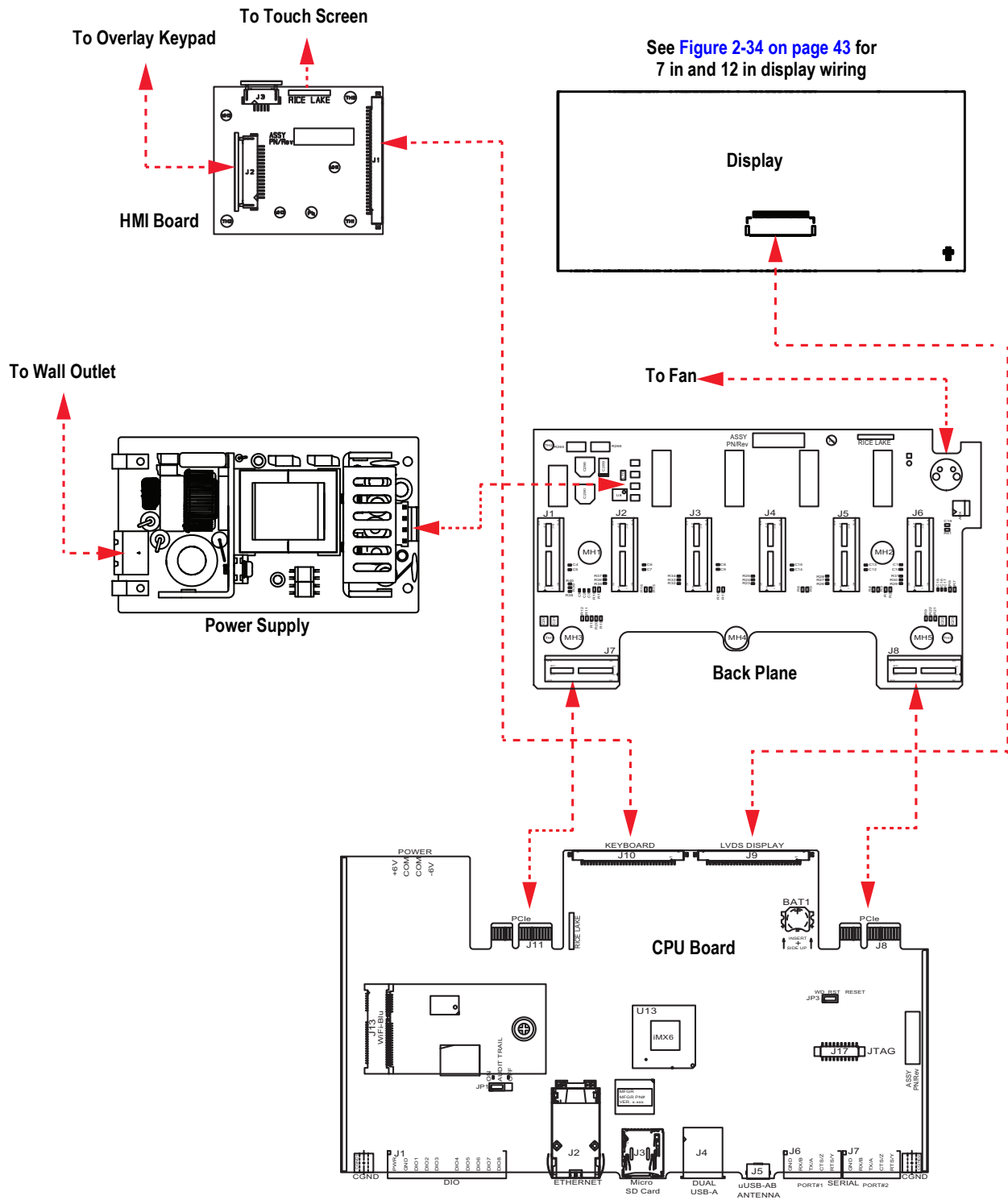

Figure 2-33. Wiring Diagram

## 2.4.2 Touch Screen Only (Virtual Keypad)

To assembly the touchscreen (virtual keypad), see [Figure 2-34](#).

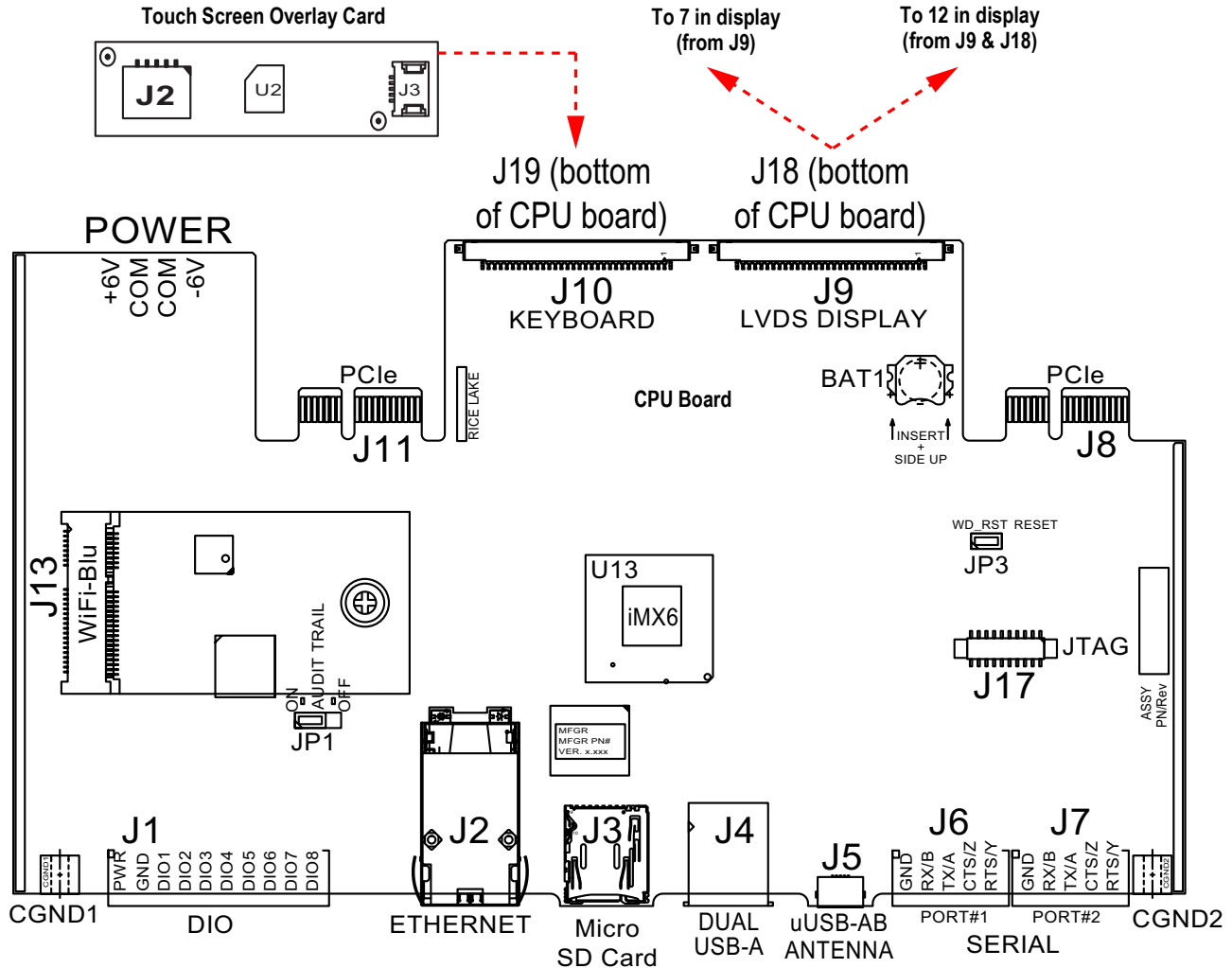

Figure 2-34. Panel Mounts – 7 Inch and 12 Inch Touch-Only

The HMI cable (PN 180002) plugs from J2 on the overlay card to J19 on bottom of CPU board.

Connect CPU to display cable (PN 164995 or 164970) from J9 to 7 in display.

Connect CPU to display cable (PN 180001) from J9 and J18 on the bottom of CPU board to 12 in display.



**NOTE:** Additional cable lengths are available.

## 2.5 Configuration Methods

The indicator can be configured using:

- Front panel keys to navigate through a series of configuration menus; see [Section 3.0 on page 57](#)
- Revolution configuration utility; see [Section 14.0 on page 125](#)
- EDP command configuration; see [Section 16.0 on page 157](#)



**NOTE:** Some configuration parameters, such as those used to configure the display and widgets, cannot be accessed through the configuration menus. Revolution provides the most complete and efficient configuration interface. See [Section 15.0 on page 141](#).

## 2.6 CPU Board Replacement

**WARNING:** Always disconnect power before opening the indicator.

**IMPORTANT:** Use a wrist strap to ground yourself and protect components from electrostatic discharge (ESD) when working inside the indicator enclosure.

\* Procedures requiring work inside the indicator must be performed by qualified service personnel only.

\* In the wall and universal mounts, the supply cord serves as the power disconnect. The power receptacle to the indicator must be accessible for these models.

1. Disconnect all cables from the controller assembly.

**IMPORTANT:** Handle with care. The boards are fragile.

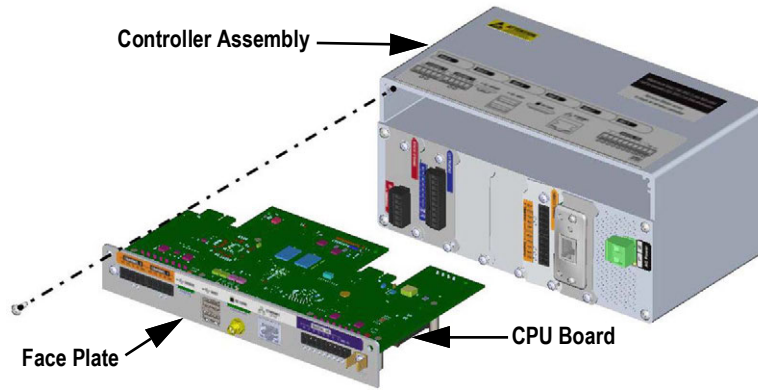

Figure 2-35. Remove CPU Board

2. Remove the two screws securing the face plate to the controller assembly.
3. Remove the face plate and board assembly from the controller.

**IMPORTANT:** Only remove the CPU board from the face plate if it is being replaced.

### 2.6.1 Remove CPU Board from Face Plate

1. Remove the nut securing the antenna.
2. Remove the two screws securing the CPU board to the face plate.

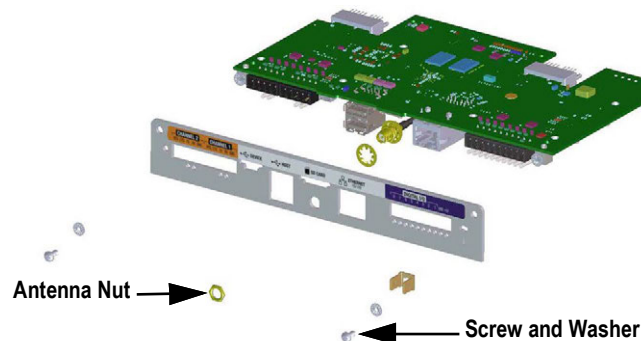

Figure 2-36. CPU Board and Face Plate

3. Separate the face plate and the CPU board.

Reverse procedure for reassembly.

**NOTE:** Recommended CPU board connection torque ratings are 2-4 in-lb (0.22-0.25 N-m).

## 2.7 Power Supply Replacement

**WARNING:** Always disconnect power before opening the indicator.

**IMPORTANT:** Use a wrist strap to ground yourself and protect components from electrostatic discharge (ESD) when working inside the indicator enclosure.

\* Procedures requiring work inside the indicator must be performed by qualified service personnel only.

\* In the wall and universal mounts, the supply cord serves as the power disconnect. The power receptacle to the indicator must be accessible for these models.

Use the following instructions to replace the power supply.

1. Disconnect all cables from the controller assembly.

**IMPORTANT:** Handle with care. The boards are fragile.

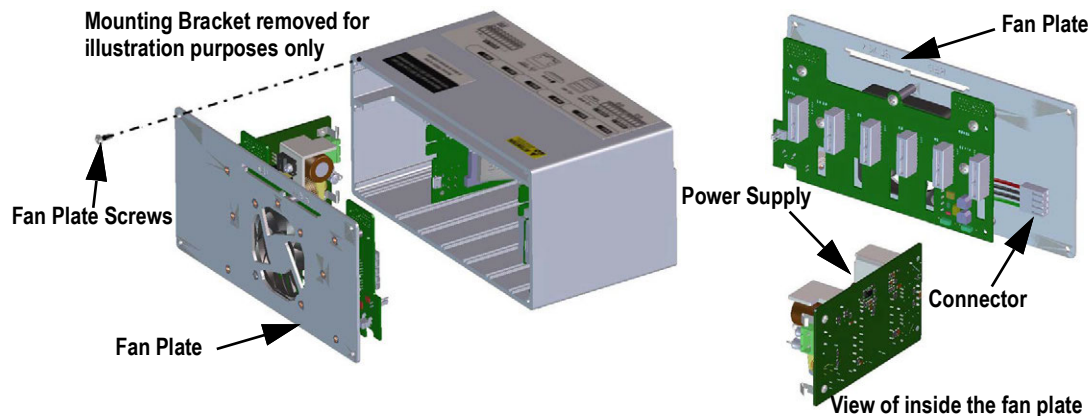

Figure 2-37. Remove Power Supply

2. Remove the four screws from the fan plate.
3. Carefully pull the fan plate/power supply assembly from the enclosure, supporting the power supply as it is removed. It is only connected to the fan plate assembly by a connector.
4. Disconnect the power supply from the connector.

Reverse procedure for reassembly.

**NOTE:** Torque connector screw terminals which secure AC and DC power to 5 in-lb (0.5 - 0.6 N-m).

## 2.8 Replace Fan Plate and Back Plane

**WARNING:** Always disconnect power before opening the indicator.

**IMPORTANT:** Use a wrist strap to ground yourself and protect components from electrostatic discharge (ESD) when working inside the indicator enclosure.

- Procedures requiring work inside the indicator must be performed by qualified service personnel only.
- In the wall and universal mounts, the supply cord serves as the power disconnect. The power receptacle to the indicator must be accessible for these models.

**IMPORTANT:** If replacing CPU boards, a new fan plate is also required.

Use the following instructions to replace the fan plate and back plane.

1. Disconnect the power supply, see [Section 2.7 on page 45](#).
2. Loosen the five screws securing the back plate board assembly and remove the board.

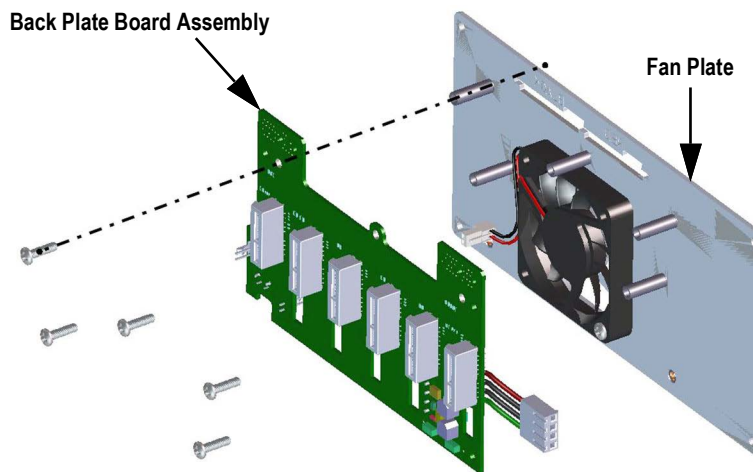

Figure 2-38. Remove Back Plate Board Assembly

**NOTE:** Orientation of the fan prior to removal. It is important the fan is reinstalled in the correct orientation.

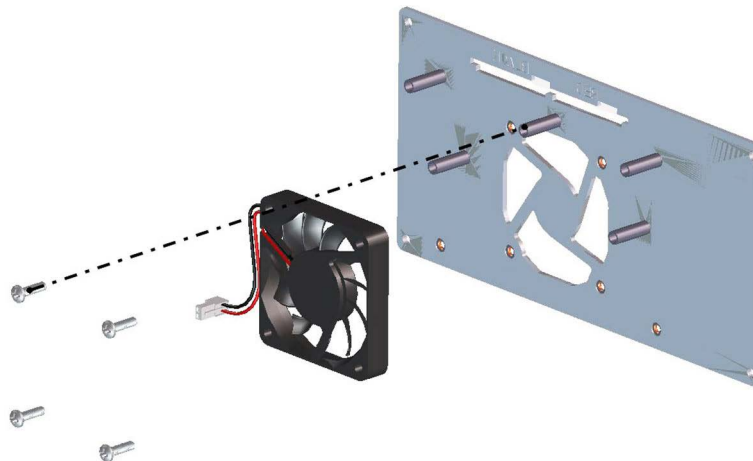

Figure 2-39. Remove Fan

3. Loosen the four screws securing the fan to the fan plate and remove the fan.

Reverse this procedure for reassembly.

## 2.9 Replacement Parts

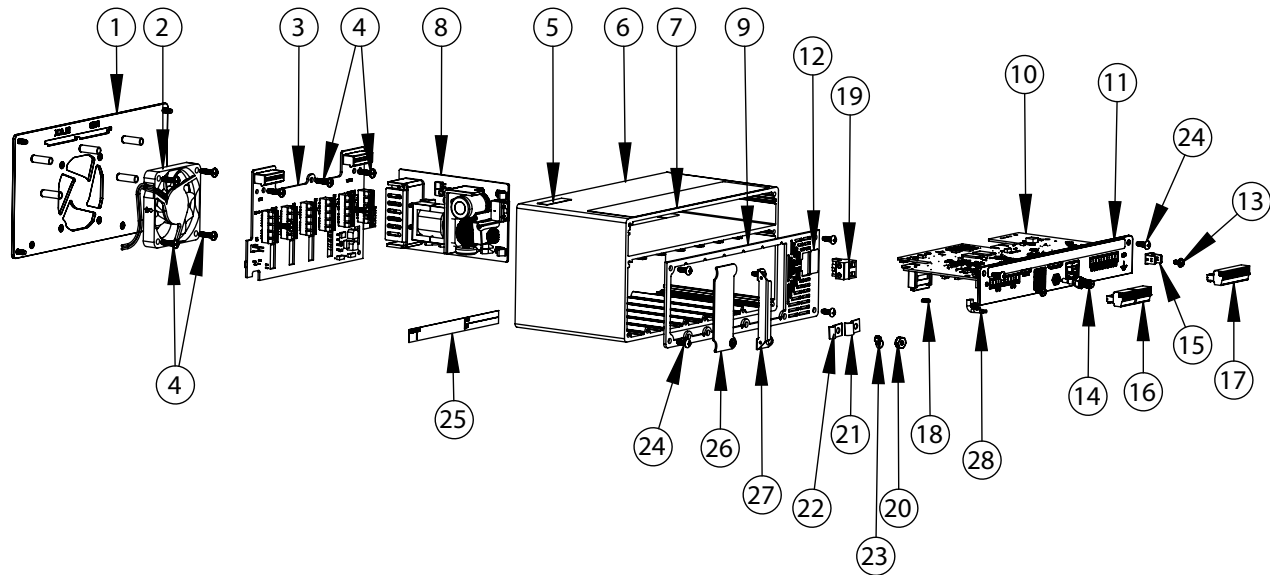

Figure 2-40. Controller Assembly Repair Parts

Item No.	Part No.	Description
1	169350	Fan Mount Plate Assembly
2	166745	Fan Assembly, 60 mm x 10 mm DC
3	160758	Board Assembly, Back Plane
4	44341	Screw, MACH 6-32 NC x 1/2 in lg
5	168591	Label, ESD Warning
6	169159	Extrusion Assembly
7	167190	Label, 1280 Controller
8	162693	AC Power Supply
	162694	DC/DC Power Supply
9	193984	Face Plate Assembly
10	179992	CPU Board Assembly with Face Plate and Fan Plate
11	193985	Face Plate, CPU PCB
12	167476	Label, AC Power
	167477	Label, DC Power
13	14822	Screw, Mach 4-40NC x 1/4 in
14	163336	Cable, Antenna Bulkhead
15	168830	Terminal, Tab 1/4 in Push
16	153882	Conn, 5 Pos Screw Terminal
17	164918	Conn, 10 Pos Screw Terminal
18	170492	Battery, Rechargeable
19	162677	Connector for AC, 2 Pos Screw Terminal
	15888	Connector for DC, 3 Pos Screw Terminal
20	14621	Nut, Kep 6-32 NC Hex
21	67550	Clamp, Ground Shield, Radius 0.125 in
22	53075	Clamp, Ground Shield, Radius 0.078 in
24	163327	Screw, Mach 6-32NC x 3/8 in
25	94422	Label, Capacity
26	163408	Blank Plate, Option Card Slot Cover
27	165927	Clip, Locking Load Cell (Kit PN 166957)

Table 2-8. Controller Assembly Repair Parts List

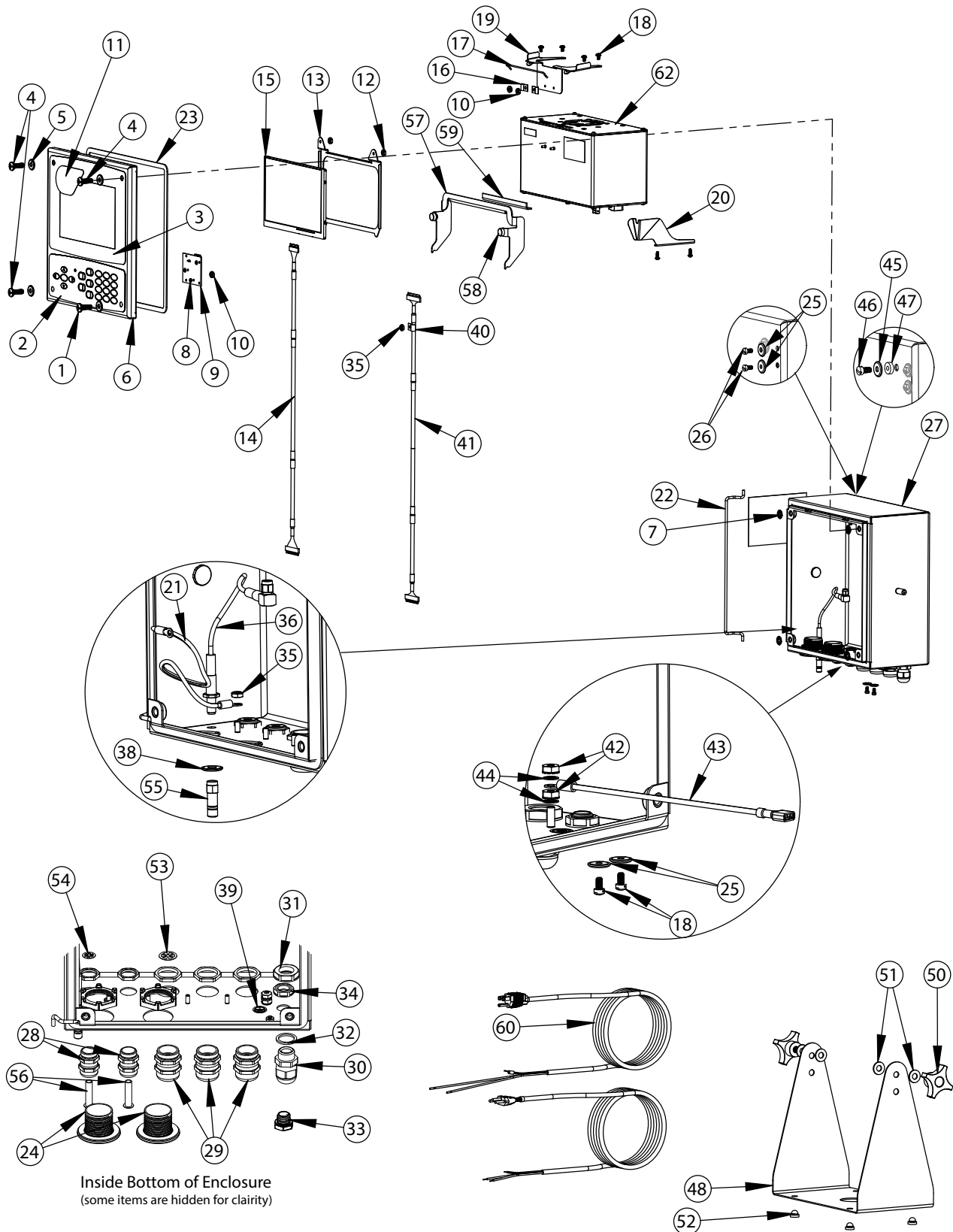

Figure 2-41. Universal Repair Parts



Item No.	Part No.	Description	Item No.	Part No.	Description
	169926	Door Assembly, Universal (inc. 1-11)	30	15626	Cord Grip, Black PG 9
1	165970	Screw, 1/4-20NC x 3/4 in Drilled Head	31	15627	Locknut, Black PCN9
2	161731	Overlay, Keypad	32	30375	Seal Ring, Nylon PG9
3	161730	Overlay, Touchscreen	33	88733	Vent, Breather Sealed
4	166631	Screw, 1/4-20NC x 3/4 in	34	88734	Nut, Breather Vent
5	182281	Washer, Washer Cup 1/4 in	35	58248	Nut, Lock 6-32 NC Hex Nylon
	182246	Washer Gasket, 1/4 in	36	166240	Cable, Antenna Extension
6	169450	Front Door, Universal	38	182281	Washer, Washer Cup 1/4 in
7	166653	Retainer, Push Nut Bolt 1/4 in		182246	Washer Gasket, 1/4 in
8	69898	Washer, Nylon #4 ID = 0.112	39	16892	Label, Ground
9	160759	Board Assembly, HMI Keypad/Touch Interface			Other Items (inc. 40-49)
10	159280	Nut, Lock 4-40 SST	40	67550	Clamp, Ground Cable Shield
11	172840	Decal, 1280 Start Screen	41	166693	Cable, CPU to HMI 18 in
	160383	Universal Display, 500 NITS (inc. 12-15)	42	14626	Nut, Kep 8-32 NC Hex
	160385	Universal Display, 1000 NITS (inc. 12-15)	43	15601	Wire, Ground 9 Inch #8
12	58248	Nut, Lock 6-32 NC HEX Nylon	44	15134	Washer, Lock NO 8 Type A
13	162272	Mounting Bracket Display (500 Nit)	45	182282	Washer Cup #10
	162271	Mounting Bracket Display (1000 Nit)	46	183662	Screw, 10-32 x 1/2, Drilled Hex Head
14	163467	Cable, CPU to Display (500 Nit) 18 in, Black	47	182247	Washer Gasket #10
	163444	Cable, CPU to Display (1000 Nit) 18 in, Black	48	161620	Stand, Tilt Surface Mount
15	163400	Display, (500 NITS) 7 in LCD		163785	Universal Parts Kit (inc. 50-56)
	163399	Display, (1000 NITS) 7 in LCD	50	164064	Hand Knob, 4-Arm 5/16-18
	169461	Universal Controller Bracket (inc. 16-20)	51	79024	Washer, Plain 5/16 in Nylon
16	53075	Clamp, Ground Cable Shield	52	42149	Bumper, Rubber Grommet
17	168545	Bail, Controller Retainer Wire	53	169879	Grounding Clip, PG 13.5
18	14839	Screw, Machine 6-32NC x 1/4 in	54	169878	Grounding Clip, PG 9
19	169462	Bracket Assembly, Controller	55	206703	Antenna, RP-SMA
20	168937	Snap Tap, Controller Support	56	19538	Post Plug, PG 9
	169927	Universal Cabinet Assembly (inc. 21-39)		172220	Post Plug, PG 13.5
21	40672	Wire Assembly, Ground 9 in		195007	Reducing Gland PG 13.5
22	169410	Hinge Link		195006	Reducing Gland PG 9
23	160379	Gasket, Front Panel		172859	Bracket Assembly (inc. 57-59)
24	124695	Panel Plug, Round Solid	57	172856	Bracket, Controller Shipping Support
25	167537	Washer, Sealing BarTite #6	58	15149	Foot, Rubber Bumper
26	183663	Screw, 6-32 x 1/4, Drilled Hex Head	59	172872	Pad, Foam
27	169452	Enclosure Shell Assembly, Universal	60	165108	Cord, US Power
28	169875	Cord Grip, PG 9 With Nut		165109	Cord, European Power
29	169876	Cord Grip, PG 13.5 With Nut	62	199157	Controller Assembly ( <a href="#">Figure 2-40 on page 47</a> )

Table 2-9. Universal Parts List

Cover exploded for clarity

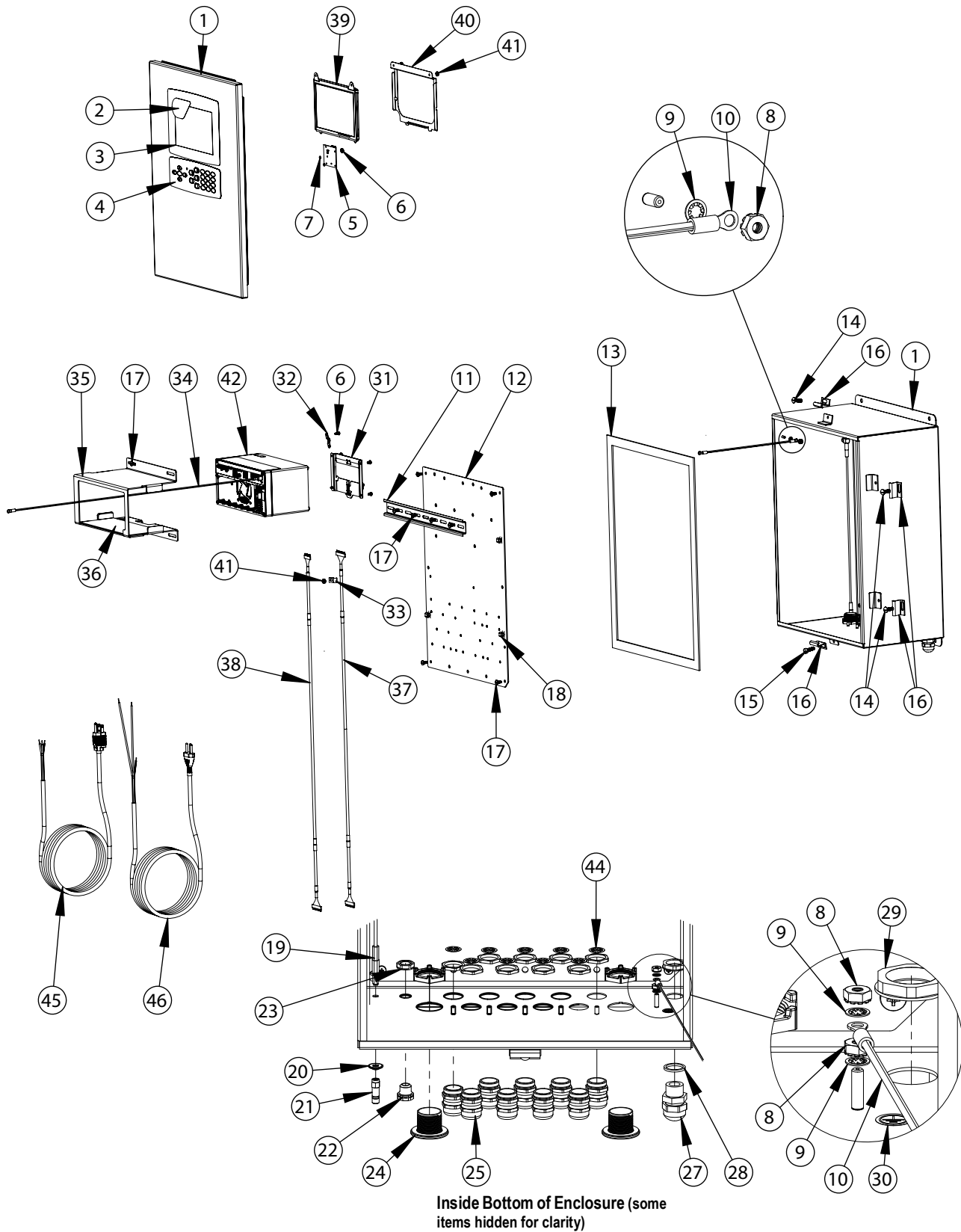

Figure 2-42. Wall Mount Repair Parts

Item No.	Part No.	Description
	164680	1280 Indicator Sub-Assembly (includes 1-34)
1	161416	Enclosure Assembly
2	172840	Decal, 1280 Start Screen
3	164120	Overlay, Touchscreen
4	164121	Overlay, Keypad
5	160759	Board Assembly, Keypad/Touch Interface
6	159280	Nut, Lock 4-40 SST
7	69898	Washer, Nylon #4 ID 0.112 in
8	14626	Nut, Kep 8-32NC Hex
9	15134	Washer, Lock No 8 Type A
10	202490	Wire Assembly, Ground 9 in
11	179418	Rail, DIN 12.75 in Length
12	164900	Back Plane Panel
13	68724	Gasket, Front Cover
14	71447	Screw, Mach 1/4 - 28NF x 3/4 in
15	71455	Screw, Mach 1/4 - 28NF x 3/4 in Drilled
16	71739	Clip, Clinching Enclosure
17	14875	Screw, MACH 10-32NF x 3/8 in
18	80590	Mount, Cable tie Arrowhead
19	166241	Cable, Antenna Extension
20	182246	Gasket, Washer Seal 1/4-Inch
	182281	Washer Shell, 1/4 Inch Sealing
22	88733	Vent, Breather Sealed
23	88734	Nut, Breather Vent
24	124695	Panel Plug, Round Solid
25	169876	Cord Grip, PG13.5 With Nut
	169875	Cord Grip, PG 9 With Nut
27	68600	Cord Grip, PG11
28	68599	Seal Ring, Nylon PG 11
29	68601	Nut, PG 11, Power Cord Cable

Item No.	Part No.	Description
30	16892	Label, Ground Protective
31	166838	Bracket Assembly, DIN Rail
32	53075	Ground Strap
33	67550	Clamp, Ground Cable Shield
34	202490	Wire, Ground 24 in #8 Eye
	173052	Bracket Assembly, 1280 (Includes 35-36)
35	172860	Bracket, 1280 Wall Mount
36	173053	Gasket, 1280 Wall Mount
37	166694	Cable, CPU to HMI 30 in
	166725	Universal Display, 500 NITS (Includes 38-41)
38	166726	Universal Display, 1000 NITS (Includes 38-41)
	164995	Cable, CPU to Display (500 Nit) 30 in
39	164970	Cable, CPU to Display (1000 Nit) 30 in
	163400	Display, (500 Nit) 7 in LCD
40	163399	Display, (1000 Nit) 7 in LCD
	162272	Mounting Bracket (500 Nit)
41	162271	Mounting Bracket (1000 Nit)
	58248	Nut, Lock 6-32NC Hex Nylon
42	199157	Controller Assembly ( <a href="#">Figure 2-40 on page 47</a> )
	163787	Parts Kit 1280 Wall Mount (Inc. items 44)
43	169879	Ground Clip, PG 13.5
	169878	Ground Clip, PG 9
	172220	Post Plug, PG 13.5
	19568	Post Plug PG 9
	195007	Reducing Gland, PG 13.5
	195006	Reducing Gland, PG 9
44	206703	Antenna, RP-SMA
45	165111	Cord, US Power
46	165112	Cord, European Power

Table 2-10. Wall Mount Repair Parts List

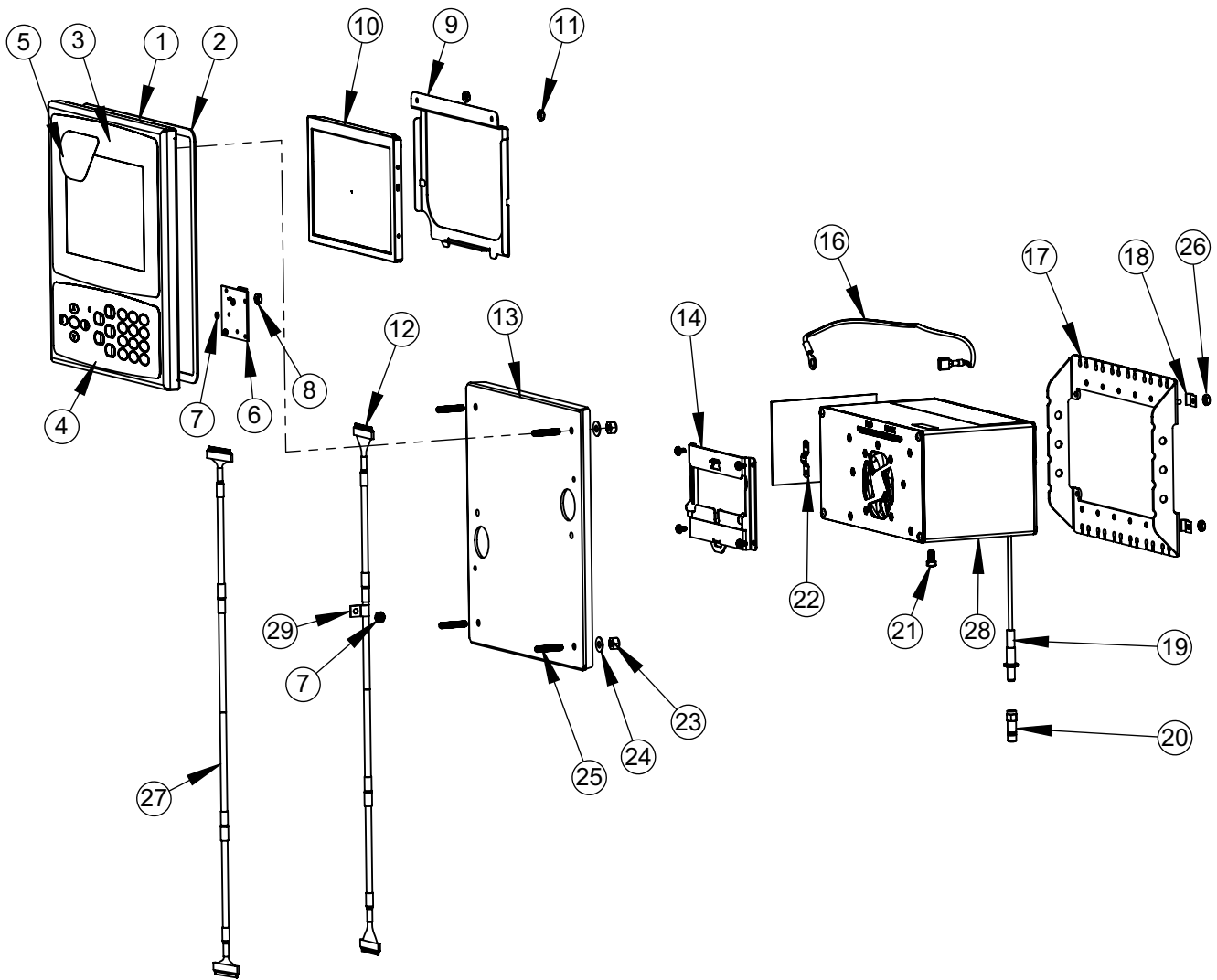

Figure 2-43. 7 Inch Panel Mount Repair Parts

Item No.	Part No.	Description
	169930	Enclosure Face Plate Assembly (Inc 1-7)
1	169929	Face Panel
2	160379	Gasket, Front Panel
3	164120	Overlay, Touchscreen
4	164121	Overlay, Keypad
5	172840	Decal, 1280 Start Screen
6	160759	Board Assembly, Keypad/Touch Interface
7	69898	Washer, Nylon #4 ID = 0.112
8	159280	Nut, Lock Nylon Insert
	166725	500 NIT Display (Inc 9-12)
	166726	1000 NIT Display (Inc 9-12)
9	162272	Mounting Bracket Display (500 Nit)
	162271	Mounting Bracket Display (1000 Nit)
10	163400	Display, (500 Nit) 7 in LCD
	163399	Display, (1000 Nit) 7 in LCD
11	58248	Nut, Lock 6-32NC Hex Nylon
12	164995	Cable, CPU to Display (500 Nit) 30 in
	164970	Cable, CPU to Display (1000 Nit) 30 in
13	186782	Mounting Plate Assembly

Item No.	Part No.	Description
14	166838	Bracket Assembly, DIN Rail
	163786	Parts Kit, Panel (Inc. 16-25 and all NS)
16	202845	Wire, 9 in Ground, 1/4 in Eye
17	169023	Ground Bus Bar
18	53075	Clamp, Ground Cable Shield
19	166241	Cable, Antenna Extension
20	206703	Antenna, RP-SMA
21	14877	Screw, Fillister 10-32NF x 3/8 in
22	168629	Ground Strap, 1280 CPU
23	14630	Nut, Lock 10-32NF Hex
24	22062	Washer, Plain No 10 Type A
25	168877	Screw, Set #10-32 x 1 in
26	14621	Nut, Kep 6-32NX Hex
NS	15130	Washer, Lock No 6 Type A
NS	158207	Screw, Mach 6-32 x 1/4 in Fillister
27	166694	Cable, CPU to HMI 30 in
28	199157	Controller Assembly ( <a href="#">Figure 2-40 on page 47</a> )
29	67550	Clamp, Ground Cable Shield
NS	14839	Screw, Mach 6-32NC x 1/4 in

Table 2-11. 7 Inch Panel Enclosure Repair Parts List



**NOTE:** If controller is not connected to the panel, ground per NEC.

Part No.	Description
14621	Nut, Kep 6-32NC Hex External Tooth Lockwasher
14630	Nut, Lock 10-32NF Hex Nylon Insert Steel
14877	Screw, MACH 10-32NF x 3/8 Slotted Drilled Fillister
15130	Washer, Lock NO 6 Type A Internal Tooth Steel
15139	Washer, Lock NO 10 Type A External Tooth Steel
158207	Screw, Mach 6-32 x 1/4 Slotted Drilled Fillister
166241	Cable, Antenna Extension 30 Inch
206703	Antenna, RP-SMA 2.4, GHz 2dBi, Whip, Tilt, SMA
168629	Ground Strap, 1280 CPU 1/4 inch Eye to Spade

Part No.	Description
202845	Wire Assembly, Ground 9 1/4 inch Eye to Spade
168877	Screw, Set #10-32NF x 1 Hex Socket Head
169023	Ground Bus Bar
17780	Ground Strap, 16 in Tinned Copper Braid
182246	Gasket, Washer Seal 1/4-Inch Fasteners
182281	Washer Shell, 1/4 in Sealing
193810	Ground Cable Clamp Small 0.08
53075	Clamp, Ground Cable Shield 0.078
67550	Clamp, Ground Cable Shield 0.125

Table 2-12. Panel Mount Parts Kit (163786) Parts List

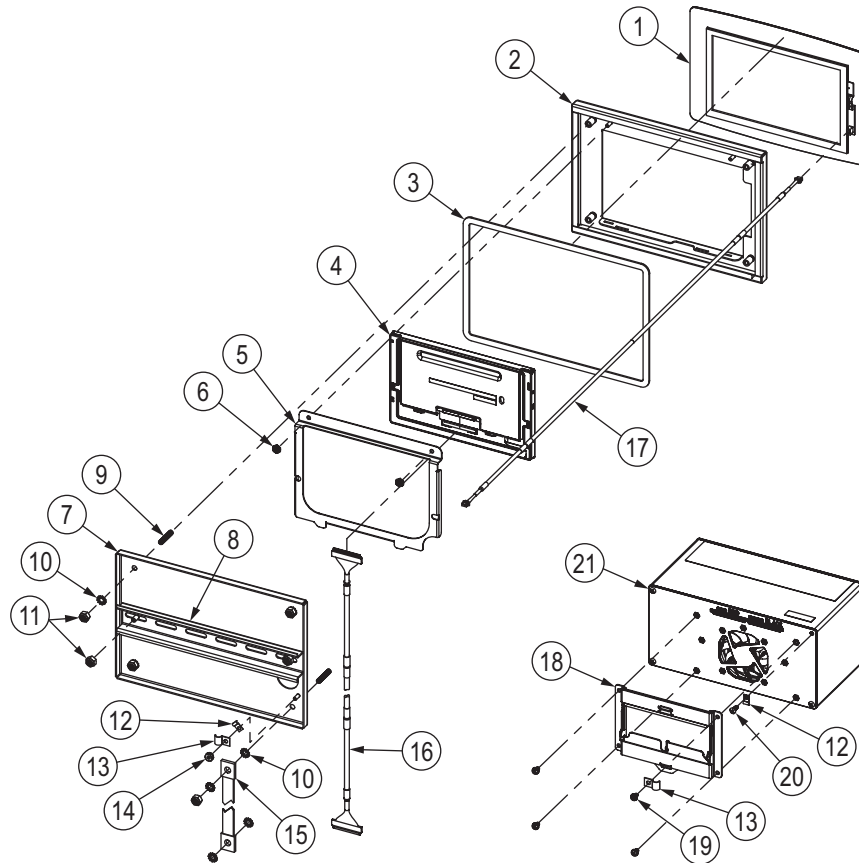

Figure 2-44. 7 Inch Touch-Only Panel Mount Repair Parts

Item No.	Part No.	Description
1	178498	Touchscreen Overlay, 7-Inch 1280 Touch Only
2	176129	Front Panel, 7-Inch 1280 Touch Only
3	176403	Gasket, 7-Inch
4	163400	Display Board, 500 NIT
	163399	Display Board, 1000 NIT
5	162272	Bracket, Display Mount 500 NIT
	162271	Bracket, Display Mount 1000 NIT
6	58248	Lock Nut, 6-32NC Nylon Insert Zinc Plated
7	176371	Mounting Plate Assembly,
8	181660	DIN Rail, 35mm x 15mm (8.5-Inch Length)
9	168877	Set Screw, 10-32NF x 1 Hex Socket Head Cup Point 18-8 SST
10	15139	Washer, Lock No 10 Type A External Tooth Steel Zinc Plated
11	14630	Lock Nut, 10-32NF Hex Nylon Insert Steel Zinc Plated
12	193810	Clamp, Small Ground Cable Shield Radius 0.08 in
13	67550	Clamp, Ground Cable Shield Radius 0.125 in
14	14621	Nut, KEP 6-32 Hex External Tooth Lockwasher Steel Zinc Plated
15	17780	Ground Strap, 16-Inch Tinned Copper Braid
16	164995	Cable, Controller to 500 NIT Display
	164970	Cable, 1280 Controller to 1000 NIT Display
17	180002	Cable, CPU to Touchscreen 30 Inches
18	166838	DIN Rail Mount Assembly, 1280 Controller
19	14839	Screw, Mach 6-32NC x 1/4 SEMS Steel Zinc Plated
20	163327	Screw, Mach 6-32NC x 3/8 Thread Rolling Phillips Pan Head Zinc Plated
21	199157	1280 Controller Assembly (Figure 2-40 on page 47)

Table 2-13. 7 Inch Touch-Only Panel Mount Repair Parts List

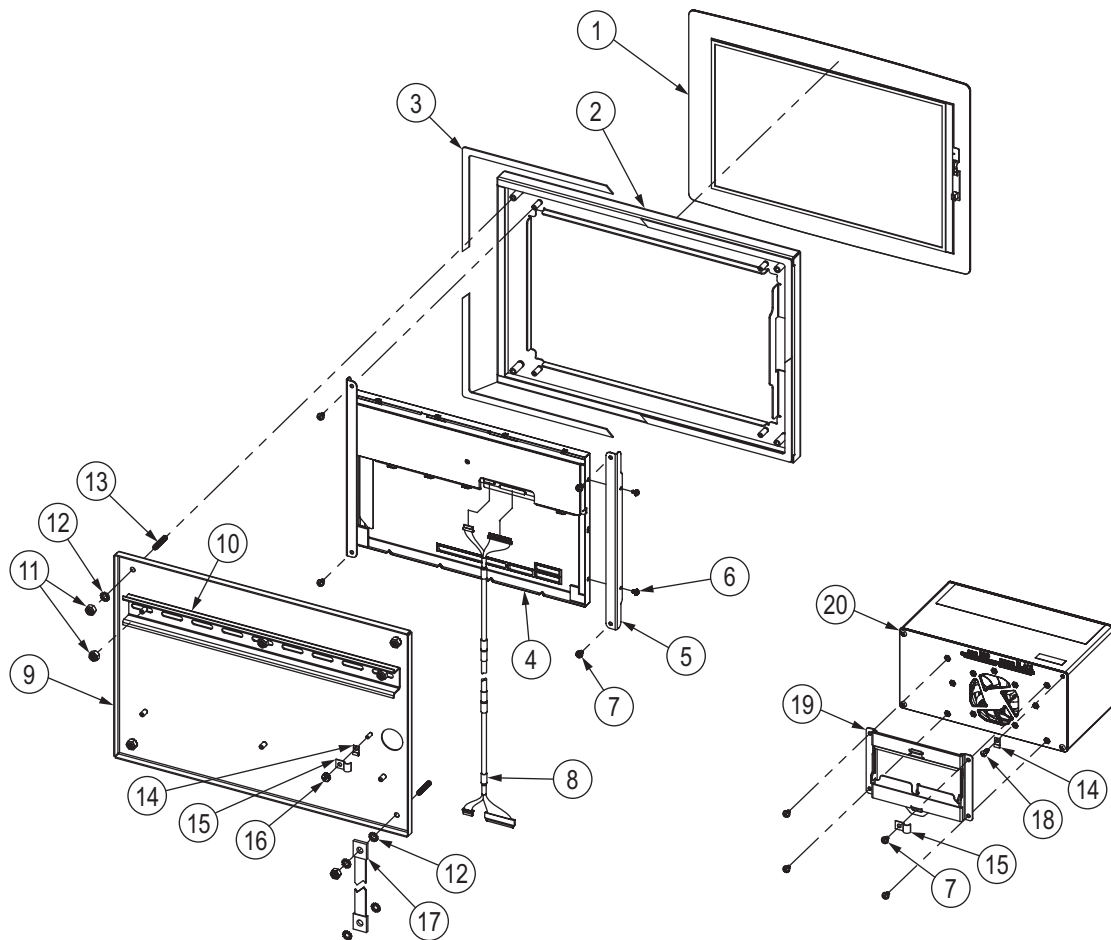

Figure 2-45. 12 Inch Touch-Only Panel Mount Repair Parts

Item No.	Part No.	Description
1	176126	Touchscreen Overlay, 12-Inch
2	176127	Front Panel Assembly, 12-Inch
3	176404	Gasket, 12-Inch Display Panel Mount
4	177396	Display Module, 12-Inch 1500 NIT
5	176242	Bracket, 12-Inch Display Mount
6	157209	Screw, Mach M3-0.5x5mm Pan Head with External Lockwasher SST
7	14839	Screw, Mach 6-32NC x 1/4 SEMS Steel Zinc Plated
8	180001	Cable, 1280 Controller to 12-Inch Display (insulated tape used to secure connection)
9	176372	Mounting Plate Assembly
10	179418	DIN Rail, 35mm x 15mm (12.75 Length)
11	14630	Lock Nut, 10-32NF Hex Nylon Insert Steel Zinc Plated
12	15139	Washer, Lock No 10 Type A External Tooth Steel Zinc Plated
13	168877	Set Screw, 10-32NF x 1 Hex Socket Head Cup Point 18-8 SST
14	193810	Clamp, Small Ground Cable Shield Radius 0.08 inch
15	67550	Clamp, Ground Cable Shield Radius 0.125 inch
16	14621	Nut, KEP 6-32 Hex External Tooth Lockwasher Steel Zinc Plated
17	17780	Ground Strap, 16 inch Tinned Copper Braid
18	163327	Screw, Mach 6-32NC x 3/8 Thread Rolling Phillips Pan Head Zinc Plated
19	166838	DIN Rail Mount Assembly, 1280 Controller
20	199157	1280 Controller Assembly ( <a href="#">Figure 2-40 on page 47</a> )

Table 2-14. 12 Inch Touch-Only Panel Mount Repair Parts List

## 2.10 Label Legend

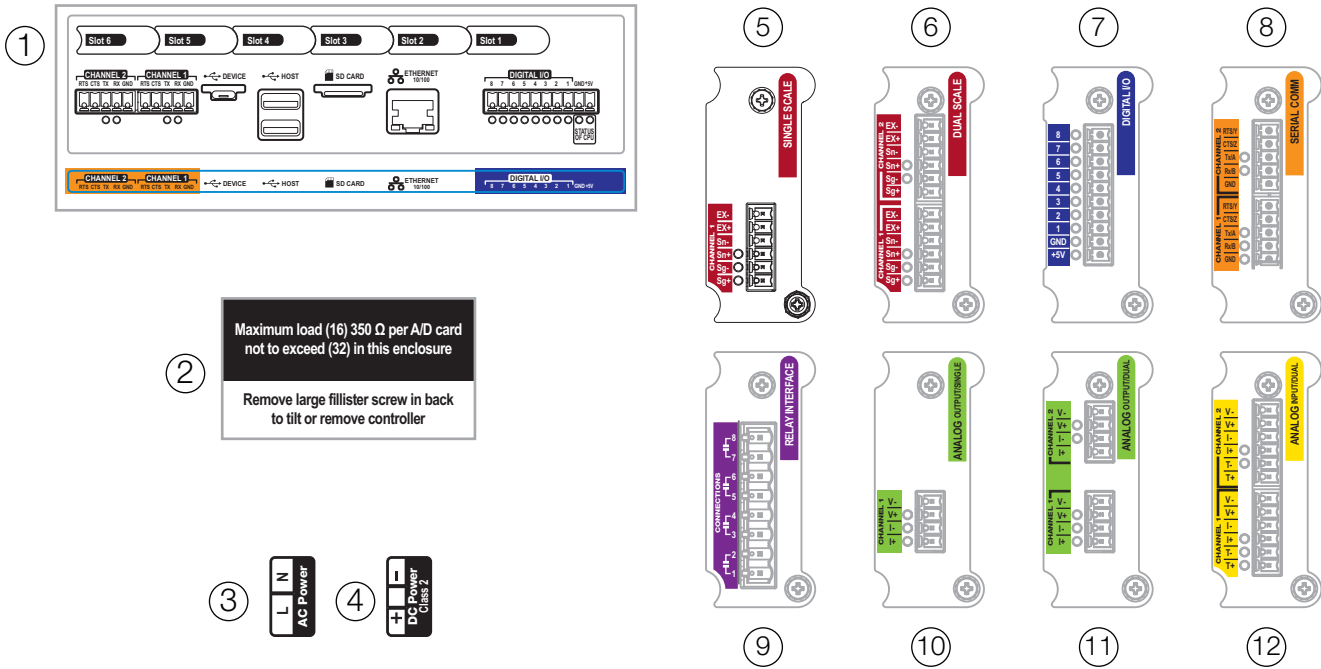

Figure 2-46. Label Repair Parts

**NOTE:** Numbers 5-12 display the position of labels on the option plate.

Item No.	Part No.	Description
1	167190	Label, 1280 Controller
2	168592	Label, Max Load (Universal Only)
3	167476	Label, AC Power 1280
4	167477	Label, DC Power 1280
5	167191	Label, Single Scale Option
6	167192	Label, Dual Scale Option
7	167193	Label, Digital IO Option
8	167194	Label, Serial Option
9	167195	Label, Relay Option
10	167196	Label, Analog Output (Single) Option
11	167197	Label, Analog Output (Dual) Option
12	167198	Label, Analog Input/Thermocouple (Dual) Option

Table 2-15. Label Repair Parts List





## 3.0 Configuration Menu

Configuration has a series of menus which allow the parameters of the indicator to be set up. Detailed descriptions of the Scale Configuration, Communications, Features, Formats, Digital I/O, Analog Output, Setpoints and Diagnostics menus are provided in [Section 4.0 on page 61](#) through [Section 11.0 on page 117](#).

**IMPORTANT:** The audit trail jumper (JP1) needs to be disabled, in the off (right) position, in order to seal the setup switch with a lead wire seal. Access is not prevented simply by sealing the setup switch.

### 3.1 Access Setup Parameters

1. Press  on the weigh mode screen. The **Main Menu** displays.
2. Press  for access to the Configuration menu. If the Configuration menu does not appear, see the following note.

**NOTE:** To access Configuration through the front panel (by pressing the button on the touchscreen, jumper JP1 needs to be in the on (left) position. In order to restrict access to Configuration using the front panel, JP1 needs to be in the off (right) position, requiring the setup switch to access Configuration, see [Figure 3-3 on page 58](#).

3. Access to the configuration menu may be restricted with a password. If prompted, enter the password and press . The Configuration menu displays, see [Section 3.3 on page 59](#).

See [Section 6.4 on page 88](#) for more information on passwords.

### 3.2 Access Configuration Menu – Sealed Indicator

If the indicator has been sealed, there is a jumper in place (JP1) which does not allow access to the configuration menu on the touchscreen. Use the following instructions to enter configuration on a sealed indicator.

1. Break the wire seal.
2. Remove the large fillister screw.
3. Use a non-conductive tool to press the setup switch inside the indicator.

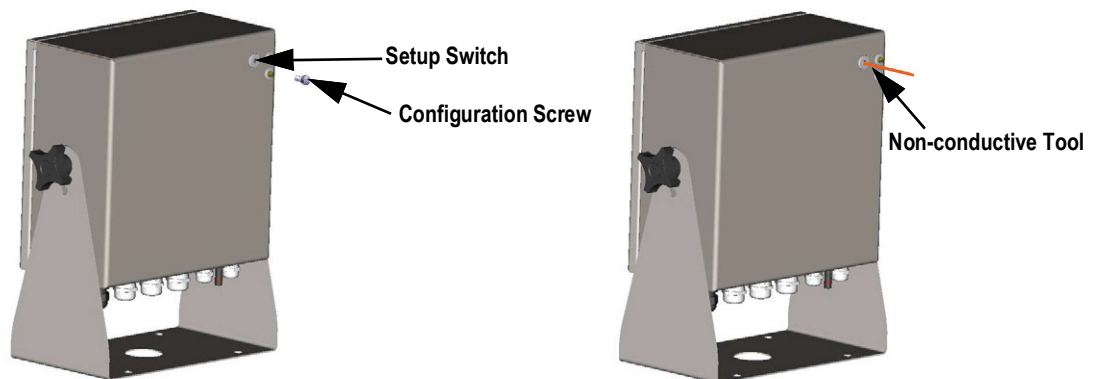

Figure 3-1. Setup Switch Location (Universal Enclosure)

**IMPORTANT:** press lightly to avoid damaging the switch or board.

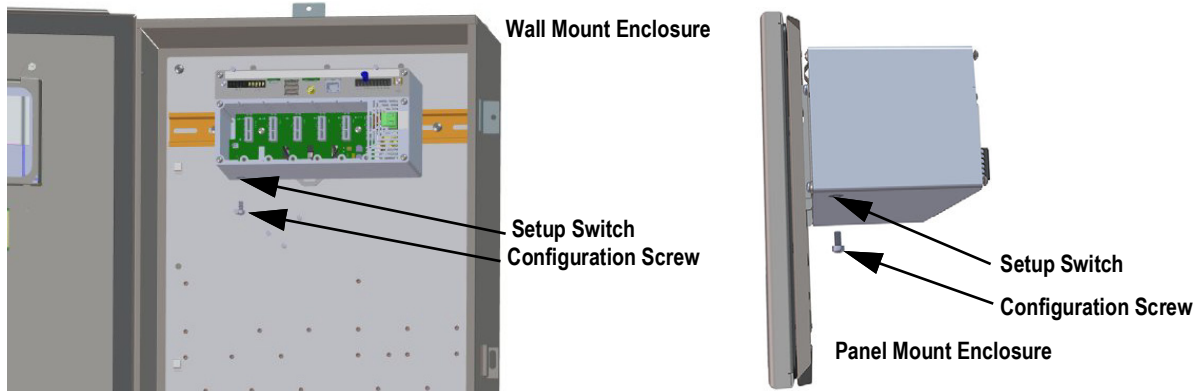

Figure 3-2. Setup Switch Locations (Panel/Wall Mount Enclosures)

4. Access to the configuration menu may be restricted with a password. If prompted, enter the password and press . The configuration menu displays, see [Section 3.3 on page 59](#).

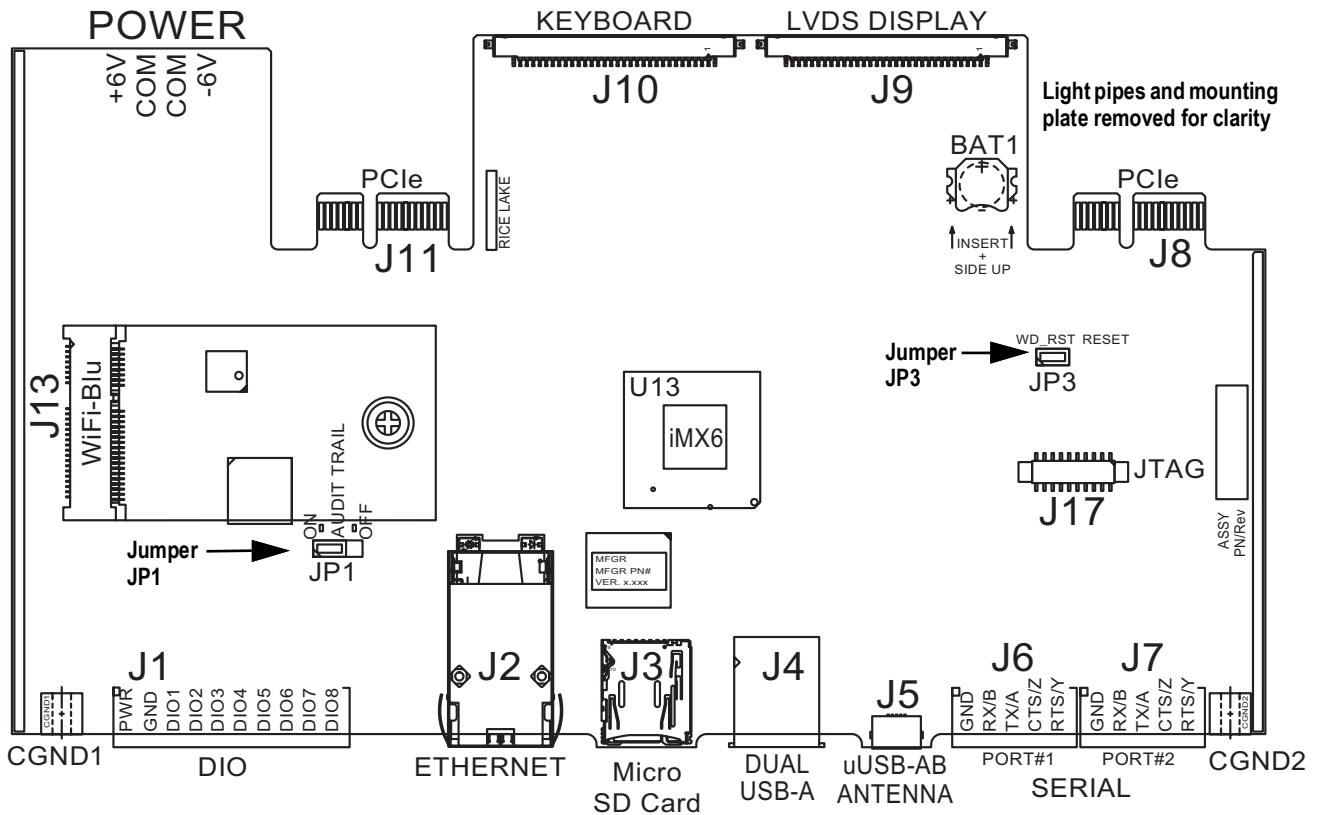

Figure 3-3. Jumper Locations



**NOTE:** The front door to the indicator may also be sealed to prevent access to the hardware. This may be required in some Legal for Trade applications.

### 3.3 Configuration Menu

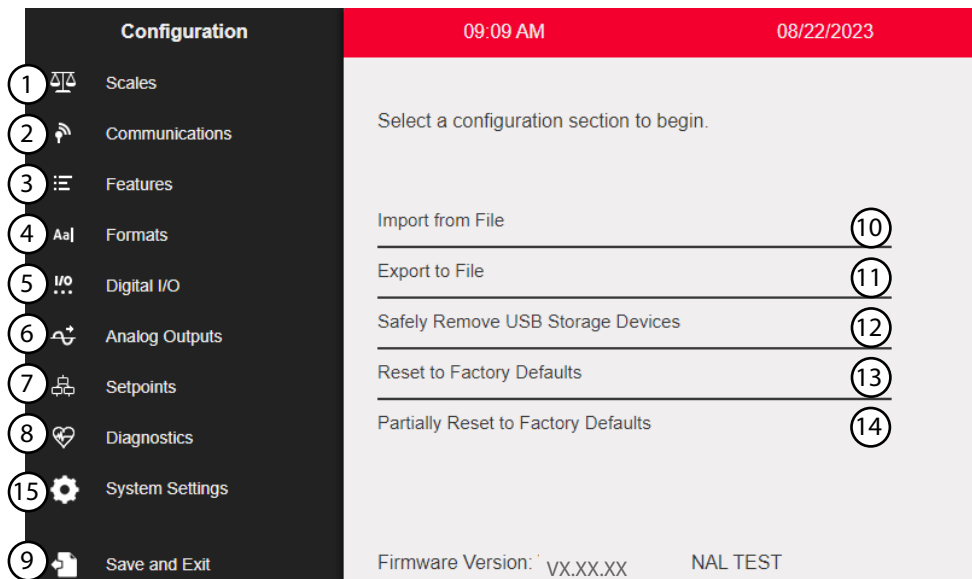

Figure 3-4. Configuration Menu

Item No.	Selection	Description
1	Scales Menu	Set the scale parameter, see <a href="#">Section 4.0 on page 61</a>
2	Communications Menu	Set the communication parameters, see <a href="#">Section 5.0 on page 73</a>
3	Features Menu	Set features parameters, see <a href="#">Section 6.0 on page 81</a>
4	Formats Menu	Set the print and stream format parameters, see <a href="#">Section 7.0 on page 92</a>
5	Digital I/O Menu	Assign functions to digital inputs and outputs, see <a href="#">Section 8.0 on page 99</a>
6	Analog Outputs Menu	Used to configure the analog output, see <a href="#">Section 9.0 on page 101</a>
7	Setpoints Menu	Used to configure setpoints, see <a href="#">Section 10.0 on page 103</a>
8	Diagnostics Menu	Recalibrate touchscreen and set the backlight, see <a href="#">Section 11.0 on page 117</a>
9	Save and Exit Button	Press to save settings and return to weigh mode
10	Import From File	Press to import an existing file, see <a href="#">Section 14.0 on page 125</a>
11	Export to File	Press to export files, see <a href="#">Section 14.0 on page 125</a>
12	Safely Remove USB Storage Devices	Press to release the USB connection before removing the flash drive or USB cable to ensure the drive continues to work properly and does not become corrupt
13	Reset to Factory Defaults	Press to restore all settings to factory defaults
14	Partially Reset to Factory Defaults	Press to partially restore settings to factory defaults, this preserves Ethernet and scale settings
15	System Settings Menu	Used to set options for devices, email, cards and update utilities, see <a href="#">Section 12.0 on page 118</a>

Table 3-1. Configuration Main Menus

## Configuration Menu Map

Figure 3-5 illustrates the menu structure in the configuration menu selections.

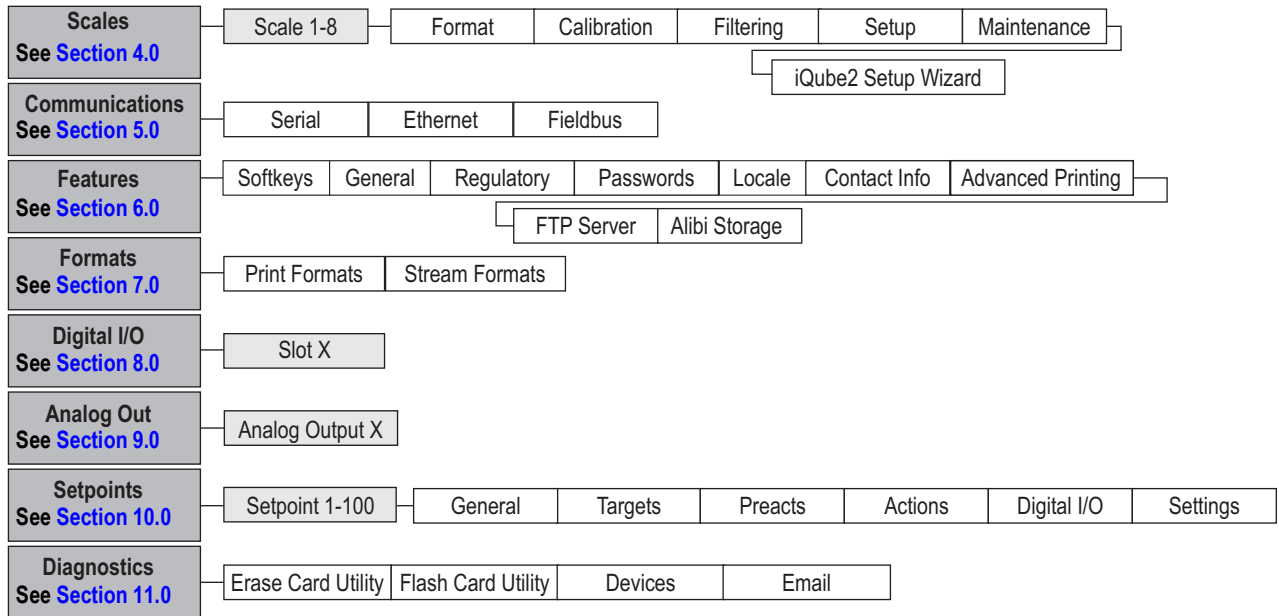



Figure 3-5. Configuration Menu Map

## 4.0 Scale Configuration

The Scales menu allows the setup of parameters for the type of scale to be set up.

From the **Configuration** menu, press  to enter the **Scales** menu. Once all parameters have been set, press  to return to weigh mode.

### 4.1 Scale Kind

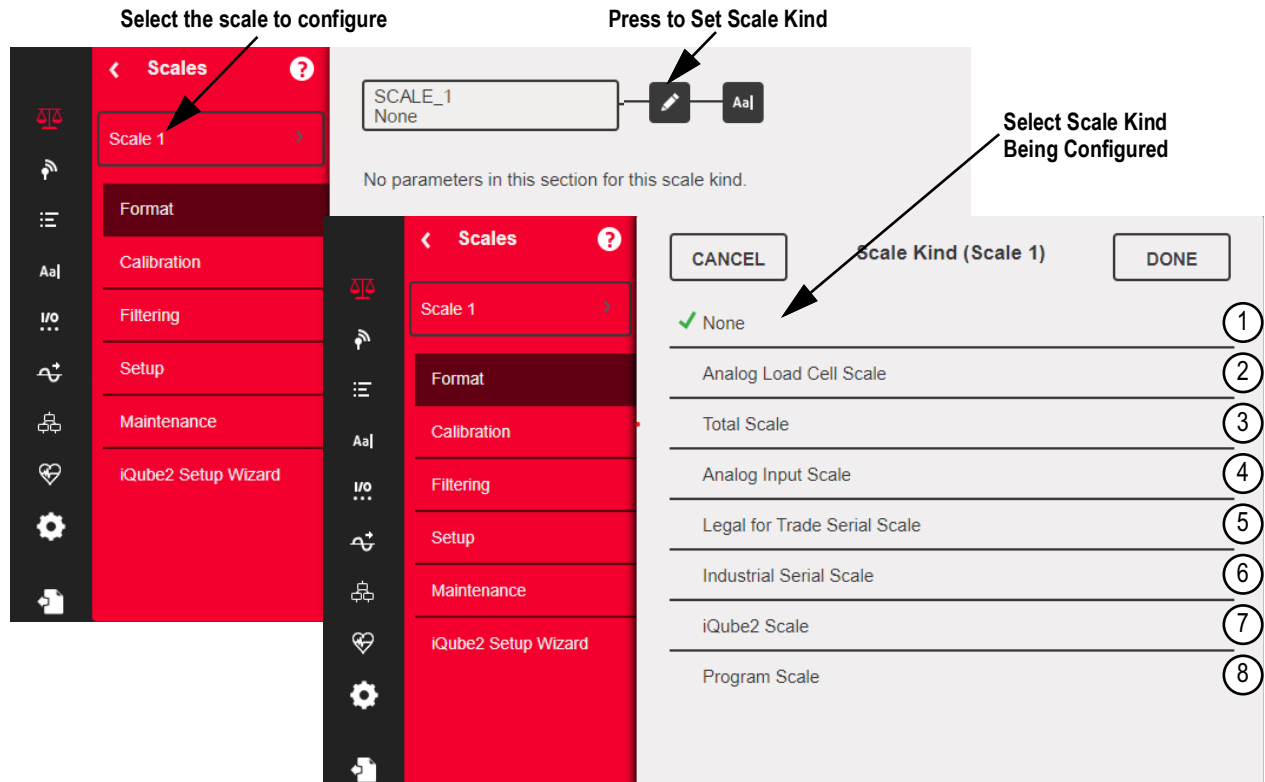



Figure 4-1. Select Scale Kind (Type)

Item No.	Parameter	Description
1	None	A scale kind is not been assigned to the scale number
2	Analog Load Cell Scale	An A/D scale card channel is used for scale (single or dual channel)
3	Total Scale	The output of two or more scales can be configured to function as a Total Scale <b>NOTE: Total Scale Kind will only total A/D or iQUBE<sup>2</sup> scales. Scales must all be the same kind.</b>
4	Analog Input Scale	An analog input card $\pm 10$ V, $\pm 0$ –100 mV, 0–20 mA, 4–20 mA is used for scale <b>NOTE: Analog card not supported in versions 1.09 and 1.10</b>
5	Legal for Trade Serial Scale	A scale receiving a stream of Legal for Trade weight data over a serial or Ethernet connection
6	Industrial Serial Scale	A scale receiving a stream of weight data over a serial or Ethernet connection; parameter values are configurable; scale functions zero and tare can be used
7	iQUBE <sup>2</sup> Scale	Scale is connected to 1280 via an iQUBE <sup>2</sup> Junction Box, see <a href="#">Section 5.4 on page 80</a>
8	Program Scale	iRite program provides the scale data

Table 4-1. Scale Kinds

## Setup a Scale

1. Select the scale (1–8) to be configured from the drop-down menu.
2. Press  to select the scale type. If applicable, available hardware to associate with the selected scale is displayed.  
*Example: An analog load cell scale has hardware identified as slot and channel.*
3. Select the scale hardware to associate with the scale or skip to [Step 4](#).
4. Press . The **Scale Kind** menu displays and the associated hardware is listed.

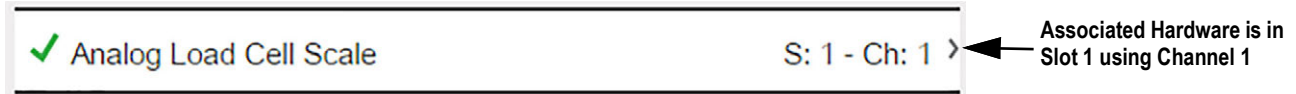



Figure 4-2. Scale Kind and Associated Hardware

5. Press .
6. Enter an alias name (optional), see [Section 4.1.1](#).

### 4.1.1 Scale Alias

An alias (name) can be entered for use in an iRite program or to identify the scale.

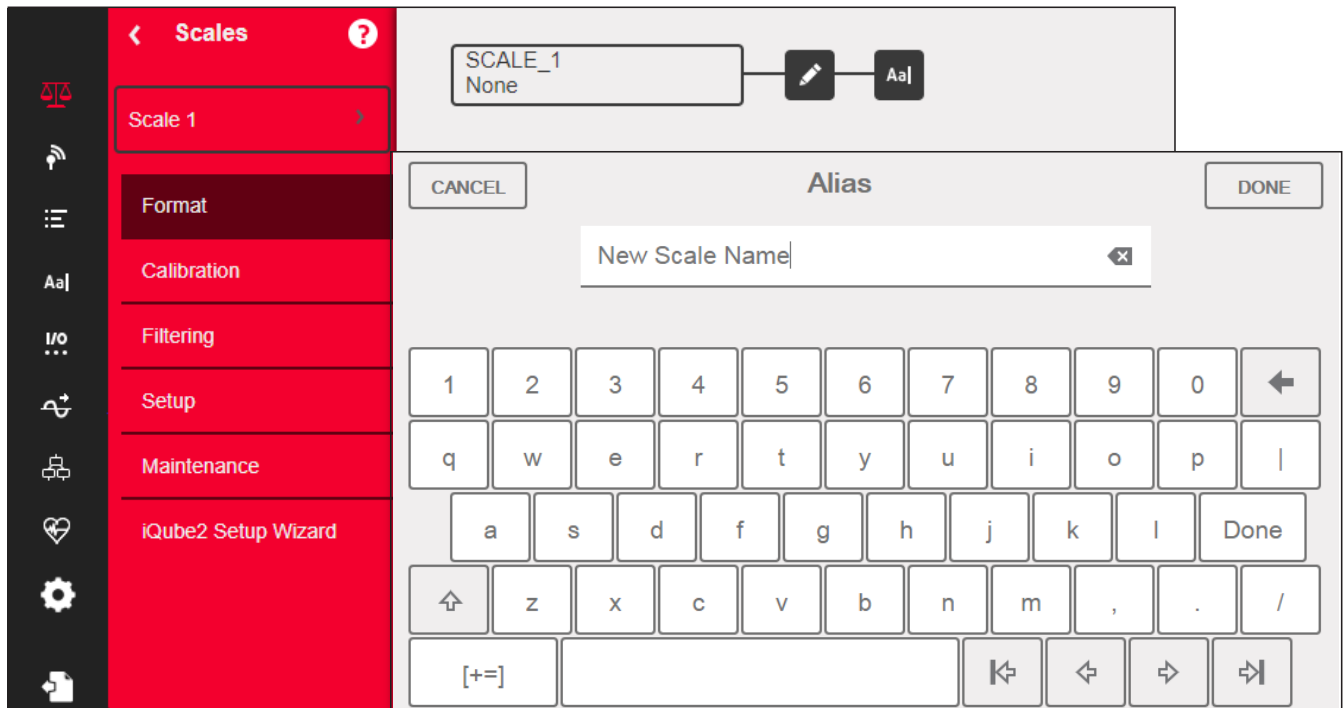



Figure 4-3. Scales Alias Setup Screen

1. Press . The keyboard displays on the screen.
2. Use the keyboard to enter the desired alias (up to 16 characters).
3. Press  when scale alias is correct.

### 4.1.2 Scale Format

The **Scale Format** menu varies depending on which scale kind is being used. Only settings available for the selected scale kind display. Options specific to the scale feature chosen are in blue font on the screen.

Parameter	Default	Description
Analog Input Type	±10 VDC	Choose electrical signal type (only available in analog input scale)
Full Scale Capacity	10,000	Capacity of the scale in primary units
Primary Units Enabled	On	The 1280 is calibrated in Primary Units; when set to <b>Off</b> , primary units do not display, but are still being evaluated in the background for all conversion functions
Primary Units	Pounds (lb)	Sets the units displayed or printed along with the scale weight
Primary Decimal Position	8888888	Number of decimal places or fixed zeros for primary units; the default is 8888888 (no decimal places)
Primary Display Divisions	1	The division the scale counts by as the load changes; associated with the Primary Decimal Position <i>Example: If the Decimal Position is set to 88888.8 and the Display Divisions are set to 5, it counts by 0.5 units.</i>
Secondary Units Enabled	Off	When set to <b>Off</b> , the <b>Units</b> key does not select this unit of measure to perform a weight conversion
Secondary Units	Kilograms (kg)	Sets the units displayed or printed along with the scale weight
Secondary Decimal Position	888888.8	Number of decimal places or fixed zeros for secondary units
Secondary Display Divisions	5	The division the scale counts by as the load changes; this setting is associated with the secondary decimal position <i>Example: If the Decimal Position is set to 88888.8 and the Display Divisions are set to 5, it counts by 0.5 units.</i>
Secondary Multiplier (Custom Units Only)	1	Use with custom units; it is the conversion factor applied to the primary units to convert weight for custom units <i>Example: If primary units were lb and secondary custom units were gallons, there is a secondary multiplier of 8 entered for the relationship between lb and gallons.</i>
Tertiary Units Enabled	Off	When set to <b>Off</b> , the <b>Units</b> key does not select this unit of measure to perform a weight conversion
Tertiary Units	Kilograms (kg)	Sets the units displayed or printed along with the scale weight
Tertiary Decimal Position	888888.8	Number of decimal places or fixed zeros for tertiary units
Tertiary Display Divisions	5	The division the scale counts by as the load changes; associated with the tertiary Decimal Position <i>Example: If the Decimal Position is set to 88888.8 and the Display Divisions are set to 5, it counts by 0.5 units.</i>
Tertiary Multiplier (Custom Units Only)	1	Use with custom units; it is the conversion factor applied to the primary units to convert weight for custom units
Custom Units One	--	Available to enter a name for custom units; maximum length is 8
Custom Units Two	--	
Custom Units Three	--	
Split Mode	Off	Multi-Range, Multi-Interval Settings, see <a href="#">Section 4.1.3 on page 64</a> for more information
Match Source	Off	Count-by of the Total Scale matches the source scales
Sum Internal Resolution	Off	When set to <b>Off</b> , Total Scale sums the adjusted displayed weights of the source scales; When set to On, Total scale sums the unadjusted weight of the source scales and applies the internal resolution (Decimal Position and Display Divisions) that is set in the Total Scale parameters

Table 4-2. Scale Format



**NOTE: Defaults are for NTEP mode.**

### 4.1.3 Split Mode

The 1280 supports multi-range and multi-interval scales of either two or three ranges or intervals. To set up Multi-Range or Multi-Interval:

1. Select **Split Mode** from the **Scales Format** menu.
2. Select **Off**, **Multi-Range** or **Multi-Interval** from the **Split Mode** menu.
3. Press **Done**.

Parameter	Description
Multi-Range	Provides two or three ranges, each extending to the maximum capacity specified for each range; the scale display division changes as the applied weight increases, but does not reset to lower display divisions until the scale returns to center of zero
Multi-Interval	Divides the scale capacity into two or three partial weighing intervals, each with different display divisions; the intervals extend to the maximum capacity specified for each interval; the display divisions change with both increasing and decreasing loads

Table 4-3. Split Mode Parameters

**Low Range Capacity (MRMI)** display once **Split Mode** is set to either **Multi-Range** or **Multi-Interval**.

Parameter	Default	Description
Low Range Capacity (MRMI)	0	Low range capacity of the scale in primary units. This parameter must be set before the indicator displays <b>Low Range Decimal Position</b> , <b>Low Range Display Division</b> or <b>Mid Range Capacity (MRMI)</b>
Low Range Decimal Position	8888888	Number of decimal places or fixed zeros for low range
Low Range Display Division	1	The division the scale counts by as the load changes; this setting is associated with the <b>Low Range Decimal Position</b> <i>Example: If the decimal position is set to 88888.8 and the display divisions are set to 5, it counts by 0.5 units.</i>
Mid Range Capacity (MRMI)	0	Mid range capacity of the scale in primary units; this parameter must be set before the indicator displays <b>Mid Range Decimal Position</b> or <b>Mid Range Display Division</b>
Mid Range Decimal Position	8888888	Number of decimal places or fixed zeros for mid range
Mid Range Display Division	1	The division the scale counts by as the load changes; this setting is associated with the <b>Mid Range Decimal Position</b> <i>Example: If the decimal position is set to 88888.8 and the display divisions are set to 5, it counts by 0.5 units.</i>

Table 4-4. Split Mode Sub-menus

If two ranges are used then:

- Low Range Capacity is set for range 1 capacity
- Full Scale capacity is set for range 2 capacity

If three ranges are used then:

- Low Range Capacity is set for range 1 capacity
- Mid Range Capacity is set for range 2 capacity
- Full Scale Capacity is set for range 3 capacity

### Configure a Multi-Range or Multi-Interval Scale

1. Select **Multi-Range** or **Multi-Interval**.
2. Press . The **Low Range Capacity (MRMI)** parameter displays in blue text under Split Mode.
3. Press **Low Range Capacity (MRMI)** to set a low range capacity. Setting a low range capacity is the only way to access the **Low Range Decimal Position**, **Low Range Display Division** and **Mid Range Capacity (MRMI)** parameters. These parameters display in blue text under **Low Range Capacity (MRMI)** after a low range capacity has been set.



**NOTE:** A **Low Range Capacity** must be set in order for further parameters to display. The **Full Scale Capacity** is either the second or third range.

4. Set the **Low Range Decimal Position** and **Low Range Display Divisions**.
5. Set the **Mid Range Capacity (MRMI)** if desired (optional). When set, the **Mid Range Decimal Position** and **Mid Range Display Division** parameters display in blue text under **Mid Range Capacity (MRMI)**.



6. Calibrate scale, see [Section 4.2](#).



Figure 4-4. Multi-Range Example



**NOTE:** When using Multi-Range, the last count-by reached is held until returning to zero, even when descending through other ranges. When using Multi-Interval, count-by changes both when ascending and descending through other intervals.

## 4.2 Scale Calibration

To enter Scale Calibration, press and select **Calibration**.

Parameters	Defaults	Description
Zero Calibration Counts	8386509	Calculated during calibration, it is the number of A/D counts after the zero calibration
Span Calibration Weight	10,000	Display and edit the test weight value; press <b>Calibrate</b> to calibrate the <b>Span Calibration Point</b> , see <a href="#">Section 4.2.1</a> for more information on Span Calibration
Span Calibration Counts	2186044	Calculated during calibration, this is the A/D count captured at the span/WVAL weight
Capacity Calibration Counts	2186044	Calculated during calibration, this is the A/D count at full scale capacity <b>NOTE: If the scale is calibrated at full capacity then Span Calibration Counts = Capacity Calibration Counts.</b>
Linear Point Weight 1-4	0	The test weight value for the linear calibration point; press <b>Calibrate</b> to calibrate the <b>Linear Calibration Point</b> , or <b>Remove</b> to remove it
Linear Point Counts 1-4	0	The A/D count captured at the linear point weight

Table 4-5. Calibration Menu



**NOTE:** Linear calibration points provide increased scale accuracy by calibrating the indicator at up to four additional points between the zero and span calibrations.

The button begins a step-by-step procedure for calibration, see [Section 4.2.1](#).

### 4.2.1 Standard Calibration

Use the following steps to perform a standard calibration on a scale.

1. Select the scale to be calibrated and enter the calibration menu.
2. Press .
3. Select the method of calibration. Press .

For other methods calibration see:

- [Section 4.2.2 on page 67](#) for multi-point calibration
- [Section 4.2.3 on page 67](#) for last zero calibration and
- [Section 4.2.4 on page 67](#) for temporary zero calibration
- [Section 4.2.5 on page 68](#) for theoretical calibration

4. Select whether or not chains, hooks or other items used for applying weights are used during calibration. Press .
5. Remove all weight from the scale except for chains and hooks (if used).
6. Press . The current weight and **Zero Calibration Complete** displays.
7. Press .
8. Enter Span weight for the value of the calibration test weights used to calibrate the scale. This is required prior to running the span calibration.

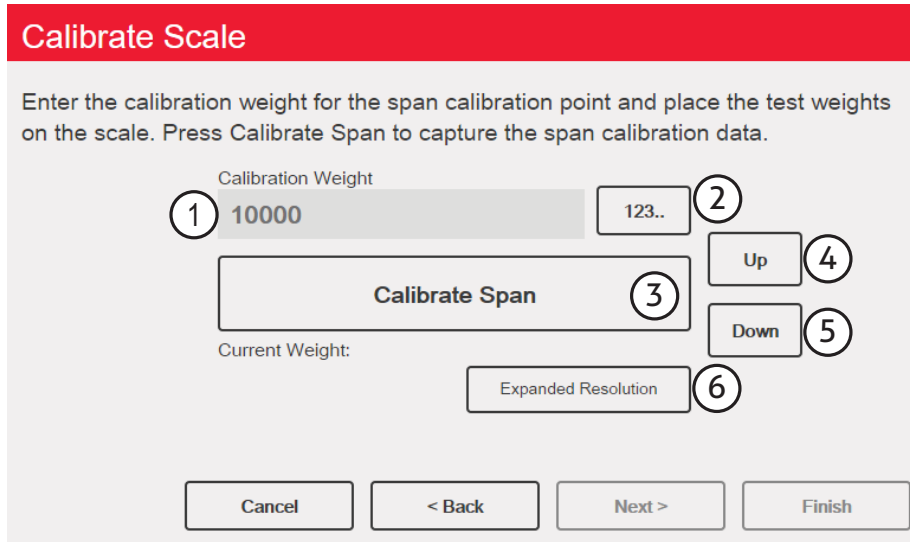

Figure 4-5. Calibrate Span

Item No.	Description
1	Calibration Weight Window – displays calibration weight value
2	123... – press to enter or edit the calibration weight value. Increments based on scale division size or the expanded resolution
3	Calibrate Span – press to calibrate span
4	Up – calibration can be adjusted by changing the calibrated weight; press <b>Up</b> to adjust the calibrated weight value up by one display division; use the Expanded Resolution to adjust the calibrated weight value by a 10th of a display division
5	Down – calibration can be adjusted by changing the calibrated weight; press <b>Down</b> to adjust the calibrated weight value down by one display division; use the Expanded Resolution to adjust the calibrated weight value by a 10th of a display division
6	Expanded Resolution – increases the resolution by a factor of 10

Table 4-6. Calibrate Span

9. Place the test weight on the scale.
10. Press . The current span weight displays.
11. Press . Calibration results are displayed.
12. Press . Display returns to the Calibration menu.
13. The re-zero function is used to remove a calibration offset when hooks or chains are used to hang the test weights during both zero and span calibration. If hooks or chains were used during calibration, remove these and the test weights from the scale.
14. Press .

## 4.2.2 Multi-Point Calibration

A multi-point calibration is performed by entering up to four additional calibration points.

Calibrate Scale

Enter the test weights for linear calibration. Press the Calibrate button for each point to capture the calibration data.

Point	Weight	123..	Current: 6000
1	2000	123..	Calibration Complete
2	4000	123..	Calibration Complete
3	6000	123..	Press to Calibrate
4	0	123..	

Linear Point Calibration Complete.

Cancel

< Back

Next >

Finish

Figure 4-6. Multi-Point Calibration

Item No.	Description
1	123... – press to enter the test weight value
2	Press to Calibrate – captures the calibration value for each point; only available after a test weight value has been entered; displays <b>Calibration Complete</b> after the calibration is finished

Table 4-7. Multi-Point Calibration

### Multi-Point Calibration

- If multi-point values have previously been entered, values are reset to zero when the initial zero calibration is performed
- **Zero Calibration** and **Span Calibration** need to be performed before adding linearization points
- Linear values must not duplicate **Zero Calibration**, **Span Calibration** or previous linear points

## 4.2.3 Last Zero Calibration

This takes the last pushbutton zero in the system (from weigh mode) and uses it as the new zero reference point, after which a new span calibration must be performed. This calibration cannot be performed when calibrating a scale for the first time.

A last zero calibration is typically used on truck scales to allow a scale verification to become a calibration without having to remove the test weights.

## 4.2.4 Temporary Zero Calibration

Temporary zero calibration temporarily zeros the displayed weight of a non-empty scale. After span calibration, the difference between the temporary zero and the previously calibrated zero value is used as an offset.

A temporary zero calibration is typically used on hopper scales to calibrate the span without losing the original zero calibration.

## 4.2.5 Theoretical Calibration

1. Select **Theoretical Calibration**. The **Calibrate Zero** screen displays.

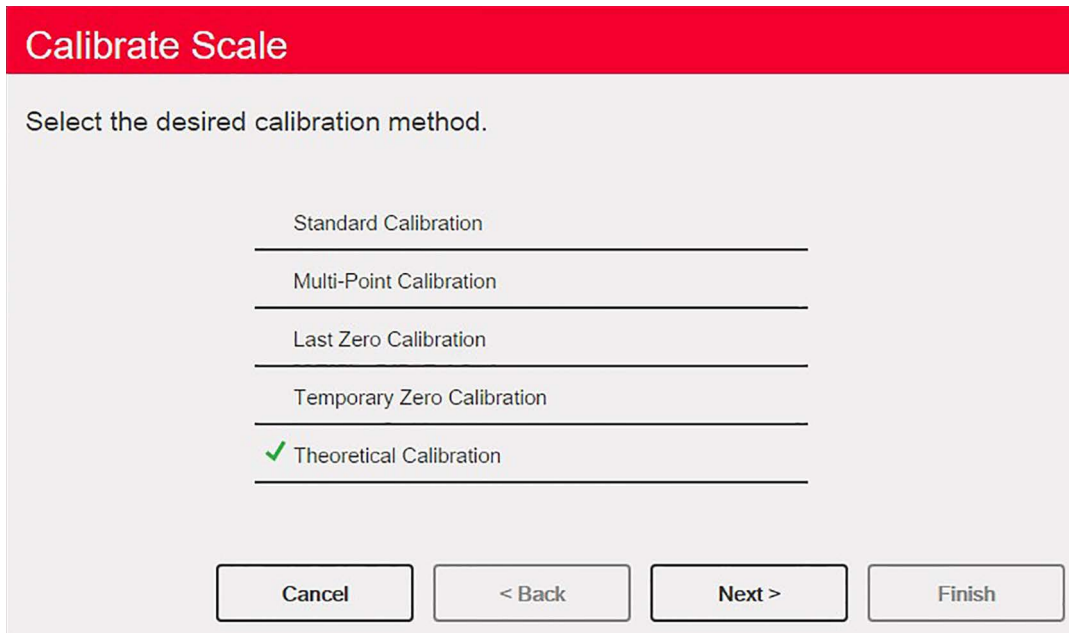



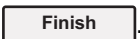

Figure 4-7. Calibration Selection Screen

2. Remove all test weights from the scale.
3. Press . The current weight and **Zero Calibration Complete** displays.
4. Press . The **Total Load Cell Build** screen displays.



**NOTE:** Total Load Cell Build is the sum of the rated capacities of all of load cells in the scale

5. Enter the total load cell build in primary units.
6. Press . The **Average mV/V** screen displays.
7. Enter the average of the mV/V of all the load cells in the scale.
8. Press . The **Calibration Results** screen displays.
9. Press . The calibration menu displays.

## 4.3 Scale Filtering

Digital filtering can be used to create a stable scale reading by removing environmental influences. The 1280 has two filtering methods which can be selected; Adaptive Digital and Three Stage Filtering. Three Stage Filtering is selected by default. In addition, the A/D sample rate and damping time constant can be set in this menu.

To enter scale filtering, press . From the **Scales** menu, select **Filtering**. The following parameters are available.

Parameter	Default	Description
Sample Rate	30 Hz	Selects measurement rate, in samples per second, of the analog-to-digital converter; the sample rate refers to how many times per second the analog signal is converted to digital; it should be set first; better stability is achieved with a lower sample rate setting so 7.5 Hz is more stable than 960 Hz
Digital Filter Type	Three Stage Filter	Sets the filter type to be used; see <a href="#">Section 4.3.1 on page 69</a> for more information on the adaptive digital filter; see <a href="#">Section 4.3.2 on page 69</a> for more information on the three stage filter
Damping Time Constant (seconds)	0.01	Used for flow control to get a smooth increase in weight; it takes two-thirds of the difference in weight change in each time period specified

Table 4-8. Filtering Menu Descriptions

### 4.3.1 Adaptive Digital Filter

The adaptive digital filter has two parameters, the response time and observe noise (instability): **Filter Sensitivity** and **Filter Threshold (Display Divisions)**. These parameters display in blue text after the **Digital Filter Type** is set to **Adaptive Digital Filter**.

Parameter	Default	Description
Filter Sensitivity	Light	Controls the stability and response time of the scale <ul style="list-style-type: none"> <li>• Heavy – results in an output which is more stable but settles slowly; small changes in weight data (a few grads) on the scale base are not seen quickly</li> <li>• Medium – has a quicker response time than heavy, but more stability than light</li> <li>• Light – fastest response to small weight changes, but less stable</li> </ul>
Filter Threshold	10	Digital filter cutout threshold (in display divisions); a weight change exceeding the threshold resets the filtered values; must be set above the noise disturbances in the system; if set to zero, the filter is disabled

Table 4-9. Adaptive Digital Filter Menu Descriptions

### Filtering Threshold

Digital filtering threshold should be set for the amount of observed noise in the system. This parameter can be set in the range of 0 to 99999 display divisions. When a new sampled weight value is acquired, the adaptive digital filter compares the new value to the previous (filtered) output value. If the difference between the new value and the previous output value is greater than the **Threshold** parameter (displayed division), the adaptive digital filter output is reset. The newly acquired sample value replaces the filtered output. If the difference between the new value and the previous output value is less than the **Threshold** parameter, the two values are averaged together using a weighed average. The weighed average is based on the time the system has been stable and the selected sensitivity setting.

The filter can be set to **Off** by entering 0 in the **Threshold** parameter.

1. To determine the initial setting for the threshold, first set the value to 0.
2. In weigh mode, determine the amount of instability which is present. Convert this instability to display divisions.  
*Example: If a heavy-capacity scale (10000 x 5 lb) produces vibration-related readings of up to 50 lb, with occasional spikes to 75 lb, record 50 lb as the threshold weight value.*
3. Set the threshold to the number of display divisions of instability.  
*Example: threshold\_weight\_value / display\_divisions*  
*With a threshold weight value of 50 lb and a display divisions value of 5 lb:  $50 / 5 = 10$ . **Threshold** should be set to 10D for this example.*
4. Further tweak this value, along with the sensitivity, to achieve the desired results. Set sensitivity for the desired response for weight changes; light for less stable but quicker responses, heavy for more stable but slower responses.

### 4.3.2 Three Stage Filter

The Three Stage Digital filter is a simple rolling average filter with three successive stages. The values assigned to each of the three stages determines the number of A/D readings averaged by the stage. The output value of each stage is passed on to the next stage at each A/D update. The overall filtering effect can be expressed by adding the values assigned to the filter stages and subtracting two.

*Example: If the filter stages were set to 16, 4 and 4, the overall filtering effect is 22 ((16+4+4)-2=22). With this configuration, a step change on the input would be fully realized on the display in 22 A/D samples. Setting the filters to 1 ((1+1+1)-2=1) effectively disables the Three Stage Filter.*

Parameter	Default	Description
Filter Sensitivity	2 Consecutive Values	Specifies the number of consecutive A/D readings which must fall outside the Filter Threshold before filtering is suspended
Filter Threshold	None	Sets a threshold value, in display divisions; when a number of consecutive A/D readings (Filter Sensitivity) falls outside of this threshold value (when compared to the output of the filter), filtering is suspended and the A/D value is sent straight through the filter; filtering is suspended if the threshold is set to <b>None</b>
Stage One Filter Value	4	Selects the digital filtering rate used to reduce the effects of environmental influences from the immediate area of the scale; choices indicate the number of A/D conversions per update which are averages to obtain the displayed reading; a higher number gives a more accurate display by minimizing the effect of a few noisy readings, but slows down the response time of the indicator
Stage Two Filter Value	4	
Stage Three Filter Value	4	
RattleTrap	Off	Enables RattleTrap filtering

Table 4-10. Three Stage Digital Filter

## Filter Sensitivity and Threshold

The Three Stage Digital filter can be used by itself to eliminate vibration effects, but heavy filtering also increases response time. **Filter Sensitivity** and **Threshold** can be used to temporarily override filter averaging to improve response time.

### Setting the Digital Filter Parameters

Use the following procedure to determine vibration effects on the scale and optimize the digital filtering configuration.

1. In setup mode, set the digital filter parameters to 1. Set **Filter Threshold** to **None**. Return indicator to weigh mode.
2. Remove all weight from the scale. Watch the indicator display to determine the amount of stability of the scale. Record the weight below which all but a few readings fall. This value is used to calculate the **Threshold** parameter value in [Step 4](#).  
*Example: If a heavy-capacity scale (10000 x 5 lb) produces vibration-related readings of up to 50 lb, with occasional spikes to 75 lb, record 50 lb as the threshold weight value.*
3. Place the indicator in setup mode and set the **Stage Filter Value** parameters to eliminate the vibration effects on the scale (leave **Threshold** set to **None**). Find the lowest effective value for the **Stage Filter Value** parameters.
4. Calculate the **Threshold** parameter value by converting the weight value recorded in Step 2 to display divisions:  
*Example: threshold\_weight\_value / display\_divisions*  
*With a threshold weight value of 50 lb and a display divisions value of 5 lb:  $50 / 5 = 10$ . **Threshold** should be set to 10D for this example.*
5. Set the **Sensitivity** parameter high enough to ignore transient peaks. Longer transients (typically caused by lower vibration frequencies) cause more consecutive out-of-band readings, so **Sensitivity** should be set higher to counter low frequency transients. Reconfigure as necessary to find the lowest effective value for the **Sensitivity** parameter.

### RattleTrap

RattleTrap filtering uses a vibration-dampening algorithm to automatically provide the best features of digital filtering. It is particularly effective for eliminating vibration effects or mechanical interference from nearby machinery. Using RattleTrap filtering can automatically eliminate environmental influences, but usually increase response time over standard digital filtering. If RattleTrap is set to on, sensitivity and threshold parameter settings are ignored.

## 4.4 Scales Setup

To enter the Scales Setup menu, press . From the **Scales** menu, select **Setup**. The following parameters are available.

Parameter	Default	Description
Tare Function	Both	Enables or disables push-button and keyed tares*
Motion Band (Display Division)	1	Sets the level at which scale motion is detected. If motion is not detected for the standstill time or longer, the standstill icon displays* <ul style="list-style-type: none"> <li>• Display divisions are between 1–100</li> <li>• If set to 0, the standstill icon is on at all times and operations including zero, print, and tare is performed regardless of scale motion; if set to 0, it is not Legal for Trade certified</li> </ul>
Overload Range	Full Scale + 2%	Determines the value, in a percentage/display division above capacity, in which the display blanks and the out-of-range error message is displayed*
Initial Zero Range (% of Capacity)	0	When the indicator is turned on and the weight value is between the $\pm$ percent range specified in Calibrated Zero, the indicator automatically zeros off the weight*
Zero Track Band (Display Divisions)	0	For small weight changes around zero, the zero track band is the value which can automatically be tracked off to return the scale to zero; it is entered in display divisions*
Zero Range (% of Capacity)	1.9	Zero range specifies the percent of capacity at which the scale can be zeroed*
Minimum Print Weight	0	The minimum print weight is the weight value which the scale must be above to allow a print; when set to zero, it is disabled
Standstill Time (Seconds)	1.0	Specifies the time (in seconds) which the scale must be out of motion before it is considered to be at standstill*
Accumulator	Off	Accumulation can be toggled On/Off. If on, accumulation occurs on print operation; if off, an accumulation does not occur

Table 4-11. Scales General Descriptions

Parameter	Default	Description
Peak Hold	Off	Used to determine, display and print the greatest weight read during a weighing cycle; the weighing cycle ends when a print command is executed (AUTO setting) or when the peak weight is cleared by pressing <b>Zero</b> or <b>Print</b> ; press <b>Gross/Net</b> to display gross weight data when using the peak hold function <ul style="list-style-type: none"> <li>• Off - peak hold function is off</li> <li>• Normal - positive peak, manual reset; greatest net weight is held in memory until the weight is removed from the scale when either the <b>Zero</b> or <b>Print</b> key is pressed</li> <li>• Bi-directional - bi-directional peak, manual reset; same as Normal, but peak value can be either positive or negative, determined by absolute value</li> <li>• Automatic positive peak, auto print, auto reset; automatic print occurs when the scale load is 0±10 display divisions and at standstill; following the print command, the peak value is cleared and reset automatically</li> </ul>
Rate of Change Decimal Point	8888888	Set decimal position for rate of change; the default is 8888888 (no decimal point)
Rate of Change Time Unit	Seconds	Time unit to be used in rate of change
ROC Capture Window (Seconds)	1.0	The time over which the rate of change is calculated
Power-up Mode	Go	When the indicator is turned on, it performs a display test then enters a warm up period <ul style="list-style-type: none"> <li>• If no motion is detected during the warm up period, the indicator becomes operational when the warm up period ends</li> <li>• If motion is detected, the delay timer is reset and the warm up period is repeated</li> </ul>
Visible	On	Specifies whether scale data is displayed
*Maximum legal value of these parameters varies depending on local regulations		

Table 4-11. Scales General Descriptions (Continued)

## 4.5 Maintenance

To enter the **Scales Maintenance** menu, press . From the **Scales** menu, select **Maintenance**. The following parameters are available.

Parameter	Default	Description
Weight Threshold	1000	The amount of weight which, when exceeded, increments the Number of Weighments
Number of Weighments	0	Displays the total number of weighments (read only)
Maximum Weighment	0	Displays the maximum weighments allowed (read only)
Date of Maximum Weighment	—	Displays the date the maximum weighment occurred (read only)

Table 4-12. Scales Maintenance Menu

## 4.6 Serial Scale Type

The Serial Scale type allows other scale indicators to send gross or net weight data to the 1280 using a continuous stream of data through a communications port.

### 4.6.1 Legal for Trade

For a Legal for Trade serial scale, the data must contain the unit of measure, mode of operation and status (in addition to the weight). The configuration of a Legal for Trade serial scale is very limited as it acts similarly to a remote display. For this reason, the scale cannot be tared or zeroed on the 1280 but must be done on the host indicator.

If the data packet for a Legal for Trade serial scale does not contain all the necessary information, or the information is incorrect, an error occurs.

## 4.6.2 Industrial Scales

For industrial scales, the only data needed is the gross weight. The data can (but does not need to) include the unit of measure, mode or status.

If the unit of measure is included, it can be used to change the capacity label on the 1280 display. If not, the 1280 always assume it is primary units.

If the mode is included, the scale displays an error if anything other than the gross mode is indicated. If the mode is not included, the weight is assumed to be gross.

If status is included, it is ignored with the exception of the center of zero indicator. The serial scale cannot determine if the reading is within the center of zero band. To obtain the center of zero band is to have the host indicator include the information (using the status token) in the data.

Though the 1280 cannot zero an industrial serial scale (zeroing must take place on the host indicator), it is possible to take a tare and display the resulting net weight.



**NOTE: Digital filtering is available with the use of an industrial serial scale. If digital filtering is enabled and the display division size of the incoming weight data is greater than the display division size of the industrial serial scale configuration, the displayed weight counts by the smaller division size, due to the averaging nature of the filters.**

## 4.6.3 Configuration

The 1280 supports serial scale data input on any of the RS-232/RS-485 ports, as well as the Ethernet TCP/IP.

1. In the **Communications** menu, select the desired port.
2. Set the **Input Type** to either **Legal for Trade** or **Industrial Serial Scale**. Set the remaining parameters as necessary to match the parameters of the incoming serial data.
3. In the **Scales** menu, set the scale kind of the scale to either **Legal for Trade Serial Scale** or **Industrial Serial Scale**.
4. Select the communication port to link to the selected scale. Only communications ports which have been configured as serial scales are displayed.
5. Set the capacity, decimal point, count-by and units to match the incoming data. This is done so the capacity label (on the display near the weight) is correct. To configure the actual format of the data, go to the **Scales/General** tab and select a stream format (1–4).
6. Navigate to the **Formats** menu, and select **Stream Formats**.
7. Select the format (1–4) in the left pane to obtain the current stream format. Either select one of the pre-defined built-in formats, or create a custom format to match the input data format. If necessary, set the token values, see [Section 7.2 on page 96](#) for more information about configuring the stream format.

If using a Legal for Trade serial scale, there are additional settings under the **Scales/General** tab; these include enabling the accumulator and visibility. If using an industrial serial scale, there are additional general settings for the tare function, overload and motion determination, as well as filter settings under the **Scales/Filtering** tab.





**NOTE: The flow of data into the indicator must be continuous – if the flow is interrupted for more than a second, a scale error occurs.**

**No matter the type, if the data received does not match exactly (as defined by the stream format configuration), the data is thrown out and a scale error occurs.**



# 5.0 Communications

The Communications menu is used for the setup of communication parameters for the 1280.

From the Configuration menu, select  to enter the Communications menu. Once all parameters have been set, press  to return to weigh mode.

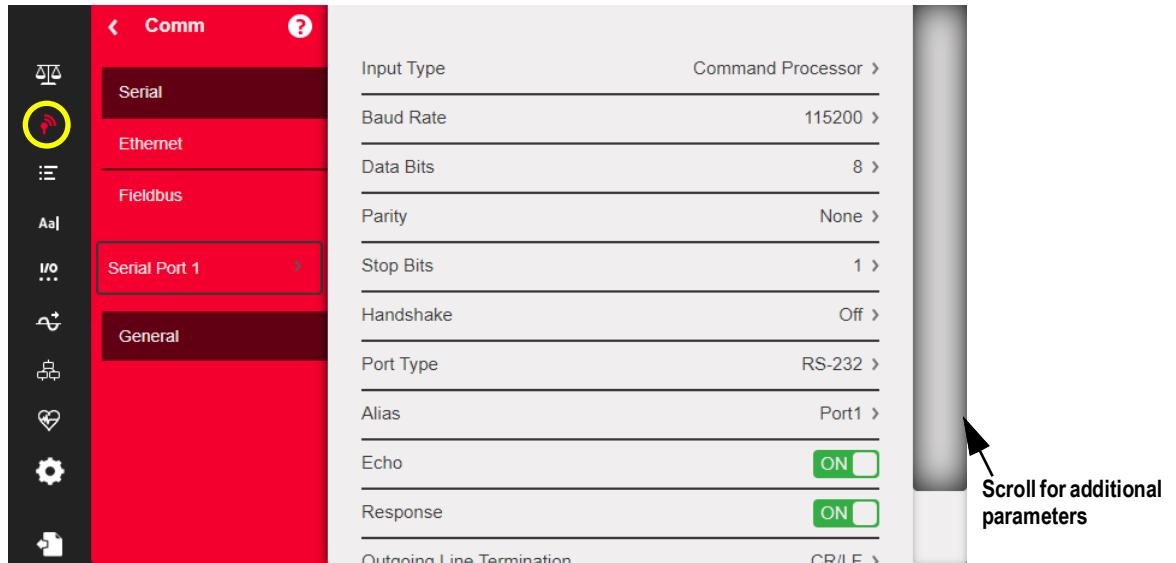

Figure 5-1. Communications Menu

Parameter	Description
Serial	To set Serial parameters, see <a href="#">Section 5.1 on page 74</a>
Ethernet	To set Ethernet parameters, see <a href="#">Section 5.2 on page 75</a>
Fieldbus	To set Fieldbus parameters, see <a href="#">Section 5.3 on page 80</a>
Selection Field	Allows selection of port or server for items 1, 2 or 3
General	General parameters for items 1, 2 or 3
iQUBE <sup>2</sup>	Select to enter iQUBE <sup>2</sup> setup, see <a href="#">Section 5.4 on page 80</a>

Table 5-1. Communication Menu Parameters

## 5.1 Serial Menu

The Serial menu is used for the setup of communication ports.

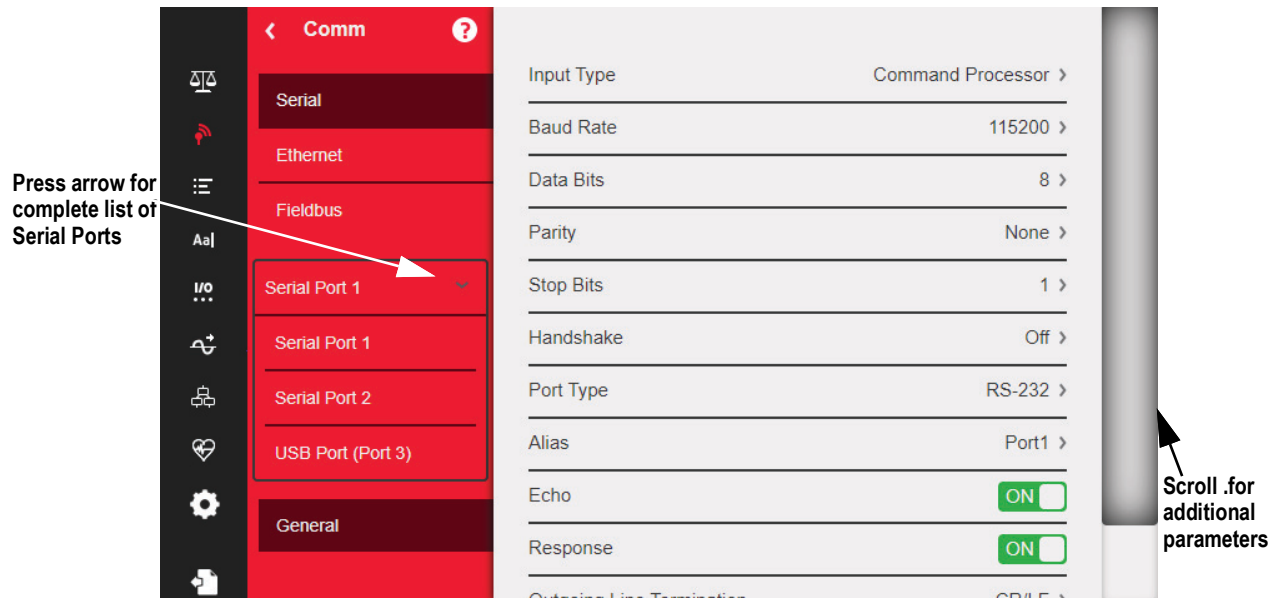



Figure 5-2. Serial Menu Screen

1. Press .
2. Select **Serial**, to enter the **Serial** menu.
3. Select the port by pressing the selection list arrow next to the serial port. The parameters in [Table 5-2](#) are available.
4. Set the parameters for the selected port, see [Table 5-3](#). Parameters vary depending on which port is being used.

Parameter	Description
Serial Port 1	Communications port support RS-232, RS-422 and RS-485 (connector J6)
Serial Port 2	Communications port support RS-232, RS-422 and RS-485 (connector J7)
USB Port (Port 3)	Micro USB device port which can be used as a communications port via a micro USB type B connector
Serial Port 5-16	Dual serial option card ports (if installed); supports RS-232, RS-422 and RS-485

Table 5-2. Available Ports

Parameter	Default	Description
Input Type	Command Processor	Sets the input type: <ul style="list-style-type: none"> <li>• Command Processor – used for EDP commands and print function</li> <li>• Programmability – used to route input to the user program</li> <li>• iQUBE<sup>2</sup> – See iQUBE<sup>2</sup> manual, PN 106113</li> <li>• Legal for Trade Serial Scale – tracks the value, mode, units and status bits of incoming data</li> <li>• Industrial Serial Scale – displays the numeric value and allows customization of tare, clear, and print functions in non Legal-for-Trade scale installations</li> </ul>
Baud Rate	115200	Selects the transmission speed for the port
Data Bits	8	Selects number of data bits transmitted or received by the port
Parity	None	Sets parity bit to odd, even or none
Stop Bits	1	Selects the number of stop bits transmitted or received by the port
Handshake	Off	Specifies if XON/XOFF flow control characters are used
Port Type	RS-232	Designates what Serial Port type is used (RS-232, RS-485, or RS-422) <b>NOTE: If RS-485 is selected, prompts are provided to select Duplex (half or full) and RS-485 Network Address.</b>
Alias	--	Allows the serial port to be renamed
Echo	On	Specifies whether characters received by the port are echoed back to the sending unit

Table 5-3. Serial Port Parameters

Parameter	Default	Description
Response	On	Specifies whether the port transmits replies to serial commands
Outgoing Line Termination	CR/LF	Selects termination character for data sent from the port
End of Line Delay (seconds)	0.0	Sets delay period from when a formatted line is terminated to the beginning of the next formatted serial output; range acceptable is 0.0–25.5 seconds
iQUBE <sup>2</sup> Sample Rate	30 Hz	Sets the rate at which the 1280 polls the iQUBE <sup>2</sup> for weight data; it is only visible when Input Type is set to iQUBE <sup>2</sup>

Table 5-3. Serial Port Parameters (Continued)

## 5.2 Ethernet Menu

The **Ethernet** menu is used for the setup of wired and Wi-Fi Ethernet connections, including Wi-Fi Direct. These are used to connect the 1280 to local area networks (WLAN and LAN). Network information can be found in weigh mode by pressing the Wi-Fi symbol or in the **Ethernet** menu in Configuration Mode.

**IMPORTANT:** If the indicator is on a network that has PoE capable Power Sourcing Equipment (PSE), the PSE must be IEEE 802.af or 802.at compliant. Any PSE that uses passive (always-on) technology will damage the Ethernet port, because it is not designed to act as an Ethernet PoE Powered Device.

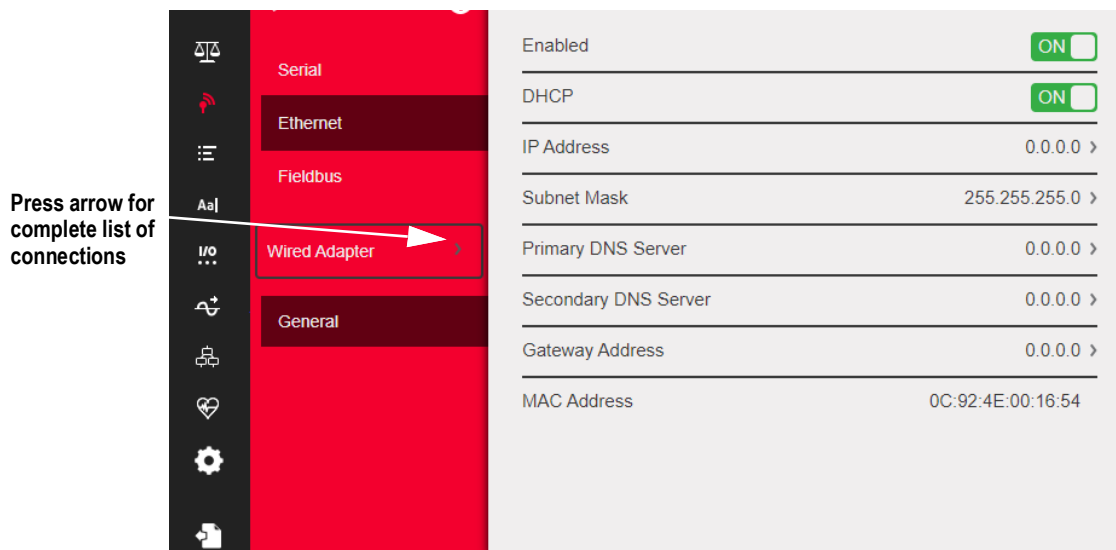



Figure 5-3. Ethernet Screen

1. Press .
2. Select **Ethernet**.
3. Press the selection field arrow to expand the Ethernet selections.
4. Select the desired Ethernet option, see [Table 5-4](#).
5. Set the parameters associated with the Ethernet type selected.

Parameter	Description
Wired Adapter	General wired Ethernet settings
Wi-Fi <sup>®</sup> Adapter	General Wi-Fi settings, Wi-Fi Direct
TCP Command Server	Specific settings for the TCP Command Server
Stream Server	Specific settings for the Stream Server
TCP Client 1	Specific settings for TCP Client #1
TCP Client 2	Specific settings for TCP Client #2
TCP Client 3	Specific settings for TCP Client #3

Table 5-4. Ethernet Selections

 **NOTE:** Contact the IT department if unsure about the required Ethernet settings for a specific network.

### 5.2.1 Using an Internet Browser as a Remote Display

A virtual display can be viewed on a computer or mobile device using an Internet browser which supports HTML 5 and JavaScript, such as Internet Explorer v10 and newer, Chrome v30 and newer or Firefox v32 and newer. In addition to viewing, virtual keypad elements can be activated by clicking on them in the browser window.

To use this feature, the 1280 and computer/mobile device must be connected to the same network. In the browser's address bar (URL), type the 1280's IP address using TCP port 3000.

*Example: If the 1280's IP address is 192.168.0.1 then navigate to <http://192.168.0.1:3000>.*

### 5.2.2 Resetting the Network Connection

If the Network connection needs to be reset for any reason, press . The available network information is displayed.

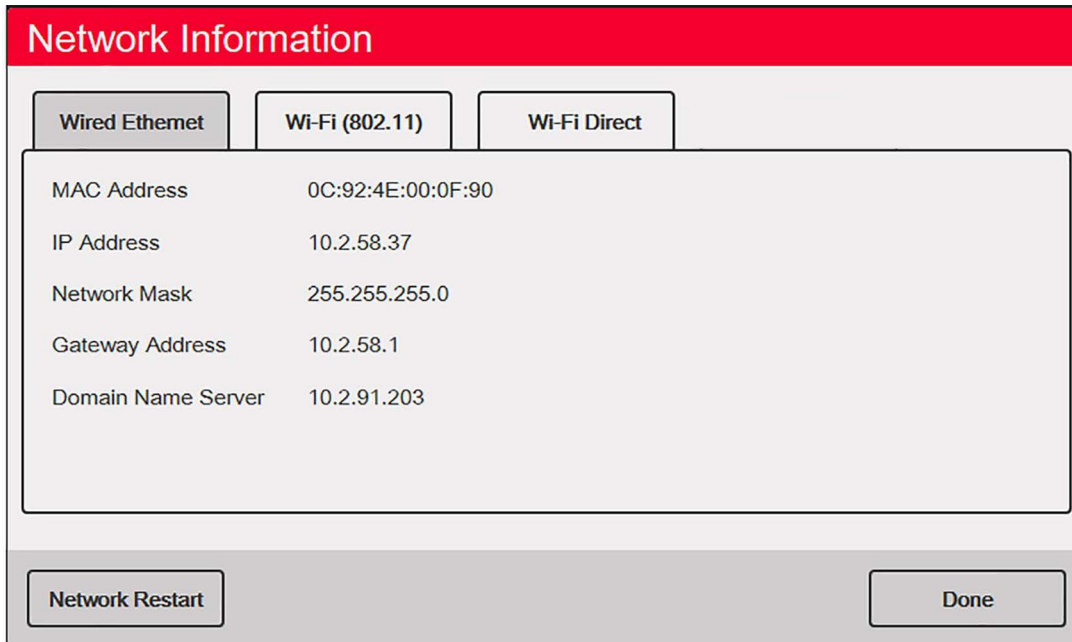

Figure 5-4. Network Information Options Screen

1. Select **Wired Ethernet** or either **Wi-Fi** tab.
2. Press **Network Restart**.
3. A prompt is displayed, **Do you want to restart all network connections?** Select **Yes** or **No**.
4. Selecting **Yes** connects to a known network connection and is then be restarted.

### 5.2.3 Wired Adapter

When **Wired Adapter** is selected, the parameters in [Table 5-5](#) display.

Parameter	Default	Description
Enabled	Off	Enable Wired Ethernet Communications – <b>Off</b> speeds up the booting process and configuration mode to weigh mode transitions
DHCP	On	Dynamic Host Configuration Protocol: On – Dynamic allocation of IP address Off – Static allocation of IP address
IP Address	0.0.0.0	Enter a four field value. The range of each field is 0–255
Subnet Mask	255.255.255.0	Specifies the subnet mask
Primary DNS Server	0.0.0.0	IP address for the server
Secondary DNS Server	0.0.0.0	IP address for the server
Gateway Address	0.0.0.0	Default gateway
MAC Address	--	View the MAC Address, in hexadecimal base (read only)

Table 5-5. Wired Adapter Parameters



**NOTE:** DNS setting must be properly configured for the network update feature to work (see [Section 14.10 on page 137](#) for more information).

### 5.2.4 Wi-Fi Adapter

When **Wi-Fi Adapter** is selected, the parameters in [Table 5-6](#) display.

Parameter	Default	Description
Enable	Off	Enable Wi-Fi Ethernet Communications – <b>Off</b> speeds up the booting process and configuration mode to weigh mode transitions
Service Set ID (SSID)	--	Name of the wireless local area network (WLAN)
Network Type	Infrastructure	Type of wireless network; choose infrastructure for connections to wireless networks
Security Type	WPA-Personal	Wireless security protocol
Encryption Type	TKIP	Wireless encryption protocol
Security Key	--	Password to access a local area network
DHCP	On	Dynamic Host Configuration Protocol On – dynamic allocation of IP address Off – static allocation of IP address
IP Address	0.0.0.0	Four field value, the range of each field is 0–255
Subnet Mask	255.255.255.0	Specifies the subnet mask
Primary DNS Server	0.0.0.0	IP address for the server
Secondary DNS Server	0.0.0.0	IP address for the server
Gateway Address	0.0.0.0	Default gateway
MAC Address	--	View the MAC Address, in hexadecimal base (read only)
Wi-Fi Direct Enabled	Off	Allows wireless connection directly to a PC, phone or tablet without a network or access point

Table 5-6. Wi-Fi Adapter Parameters

 **NOTE:** DNS setting must be properly configured for the network update feature to work (see [Section 14.10 on page 137](#) for more information).

### 5.2.5 Wi-Fi Direct

Wi-Fi Direct is a feature of Wi-Fi which allows wireless connection directly to a PC, phone or tablet.

 **NOTE:** Wi-Fi need not be enabled for Wi-Fi Direct to be enabled.  
If incorrect credentials are entered into the Wi-Fi parameters, Wi-Fi Direct will not operate.

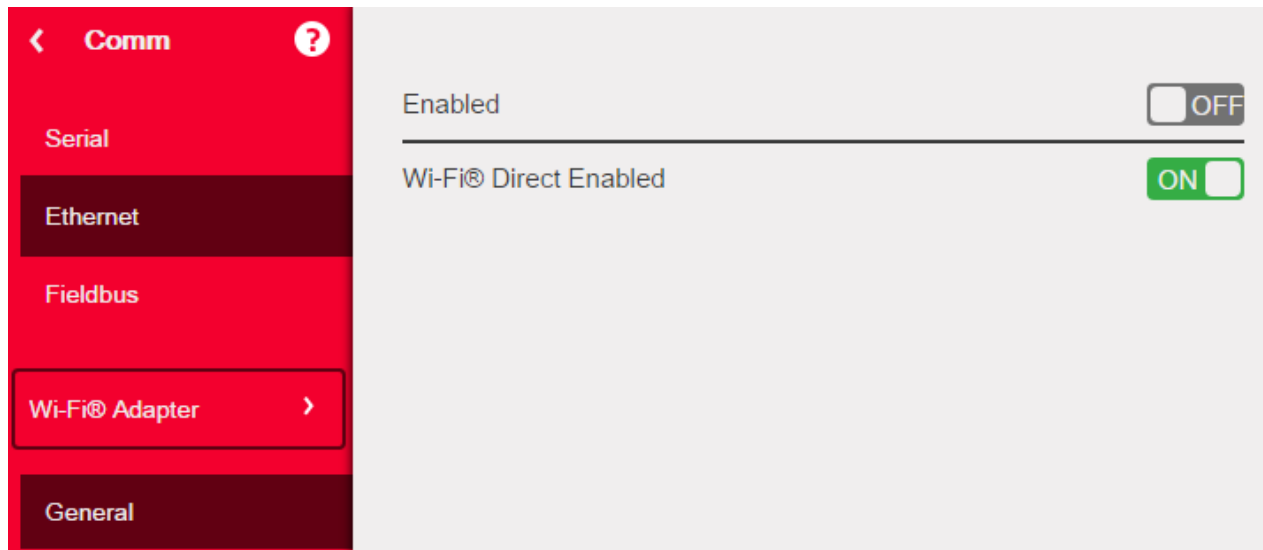





Figure 5-5. Enable Wi-Fi Direct

1. Select **Ethernet**.
2. Press the selection field arrow to expand the Ethernet choices.
3. Select the **Wi-Fi Adapter** list option.
4. Enable the **Wi-Fi Direct** option.
5. Press .  displays briefly then display returns to the weigh mode.

6. Press . The available Network Information is displayed.

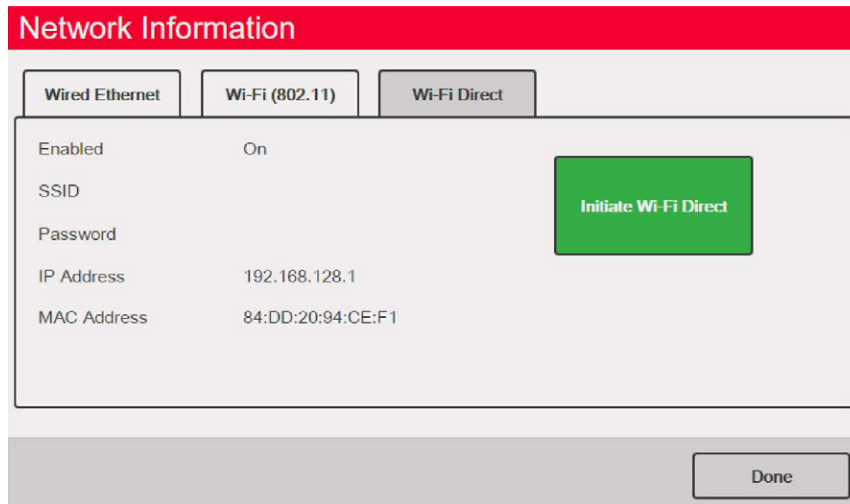

Figure 5-6. Wi-Fi Options Screen

7. Select the **Wi-Fi Direct** tab.
8. Press **Initiate Wi-Fi Direct**.
9. Wi-Fi Direct is assigned an SSID and Password. Write these down, they are required when connecting to another device.



**NOTE: A new SSID and Password is created each time a Wi-Fi Direct connection is initiated.**

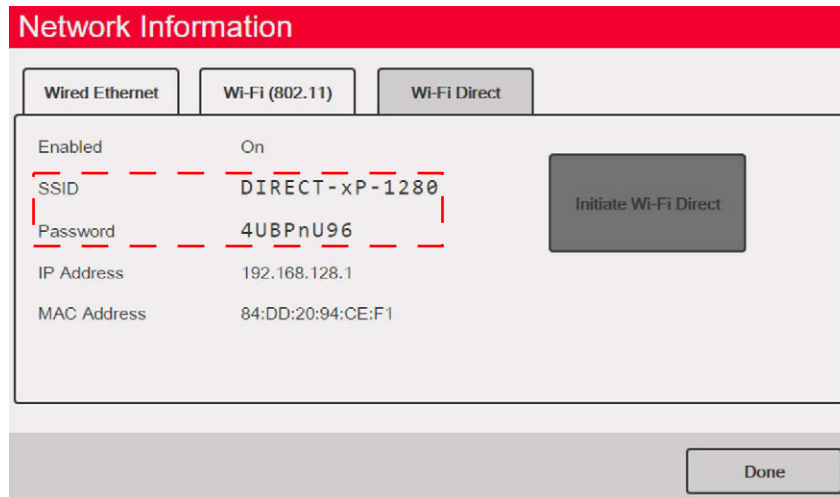



Figure 5-7. SSID and Password for Wi-Fi Direct

10. Press . The weigh screen is displayed.
11. Using the PC, mobile phone or iPad/tablet, enter settings then Wi-Fi selections. The name of the 1280 SSID should be displayed as an option in the Wi-Fi selections.
12. Select the 1280 SSID from the list, a screen displays asking for the Password.
13. Enter the Password from [Step 9](#).
14. To disable Wi-Fi Direct, go back to the communications/Ethernet menu to disable.



**NOTE: Using Wi-Fi Direct does not interrupt the use of Wi-Fi.**

**Enabling the Wi-Fi requires Wi-Fi Direct to be re-initiated.**

**Wi-Fi direct can utilize all Ethernet connection types (TCP command server, Stream Server, TCP Client 1 & 2).**

## 5.2.6 TCP Command Server

Parameter	Default	Description
Enabled	On	Enable/Disable access to the TCP server and the ability to send EDP commands via TCP
Input Type	Command Processor	Sets the input type
Server Port Number	10001	TCP/IP port number
Alias	--	Allows the server to be renamed
Echo	Off	Specifies whether characters received by the port are echoed back to the sending unit
Response	Off	Specifies whether the port transmits replies to serial commands
Outgoing Line Termination	CR/LF	Selects the termination character for data sent from the port

Table 5-7. TCP Command Server Parameters

## 5.2.7 Stream Server

Parameter	Default	Description
Server Port Number	20001	Stream server port number
Alias	--	Allows the server to be renamed
Outgoing Line Termination	CR/LF	Selects termination character for data sent from the port

Table 5-8. Stream Server Parameters

## 5.2.8 TCP Client 1, 2 & 3

Parameter	Default	Description
Input Type	Command Processor	Sets the input type
Remote Address	0.0.0.0	IP Address of the remote server listening for the connection request from the 1280
Remote Port Number	10001	TCP port number on the remote server listening for the connection request from the 1280
Alias	--	Allows the client to be renamed
Outgoing Line Termination	CR/LF	Selects termination character for data sent from the port
End of Line Delay (seconds)	0.0	Sets the delay period, in 0.1 second intervals, from when a formatted line is terminated to the beginning of the next formatted output
Echo	On	Specifies whether characters received by the port are echoed back to the sending unit
Response	On	Specifies whether the port transmits replies to commands
Disconnect Time (seconds)	3 seconds	The amount of time an active connection is held before it is dropped; setting value to 0 will prevent automatic disconnect
iQUBE <sup>2</sup> Sample Rate	30 Hz	Sets the rate at which the 1280 polls the iQUBE <sup>2</sup> for weight data; it is only visible when the Input Type is set to iQUBE <sup>2</sup>

Table 5-9. TCP Client 1, 2 & 3 Parameters

## 5.3 Fieldbus Menu

The Fieldbus menu allows the selection of the slot (1-6) to be used for one of the CompactComm Options.

1. Press .
2. Select **Fieldbus**.
3. Press the arrow next to the Slot # and select the slot required.

Parameter	Default	Description
Data Swap	None	Specifies Byte, Word, Both or none of the data sent and received by the fieldbus card
iRite Fieldbus Data Size (Bytes) (0=disabled)	0	Specifies the data size, in bytes which the iRite Fieldbus command handler transfers; values must be in multiples of four
DeviceNet Address	63	Enter DeviceNet option address 1–64
Profibus Address	126	Enter Profibus option address 1–126

Table 5-10. Fieldbus Menu Descriptions

### Data Swap

If the values returned from the 1280 do not appear to be correct, change the Data Swap parameter to **Byte**, **Word** or **Both**. These parameters change the order of the data to enable compability with the way the device handles the data in its memory. It is best to change the data order in the device being used, but if it is not possible, Data Swap is the best alternative.

## 5.4 iQUBE<sup>2</sup> Scale

The 1280 can be digitally connected to multiple load cells using one or more iQUBE<sup>2</sup> junction boxes. The iQUBE<sup>2</sup> can be set up in the 1280 using setup wizard located in the Scales menu or through the setup menu located in the communications menu. More information on the setup of the iQUBE<sup>2</sup> can be found in the iQUBE<sup>2</sup> Technical Manual (PN 106113).





**NOTE:** iQUBE<sup>2</sup> scales cannot be used with the 1280 Total Scale function. Totaling 2-4 iQUBE<sup>2</sup> scales is a function within the iQUBE<sup>2</sup> setup menu.



## 6.0 Features

The Features menu allows the setup of parameters for the menu items listed in [Table 6-1](#).

From the Configuration menu, select  (circled in [Figure 6-1](#)) to enter the Features menu.

Once all parameters have been set, select  to return to weigh mode.

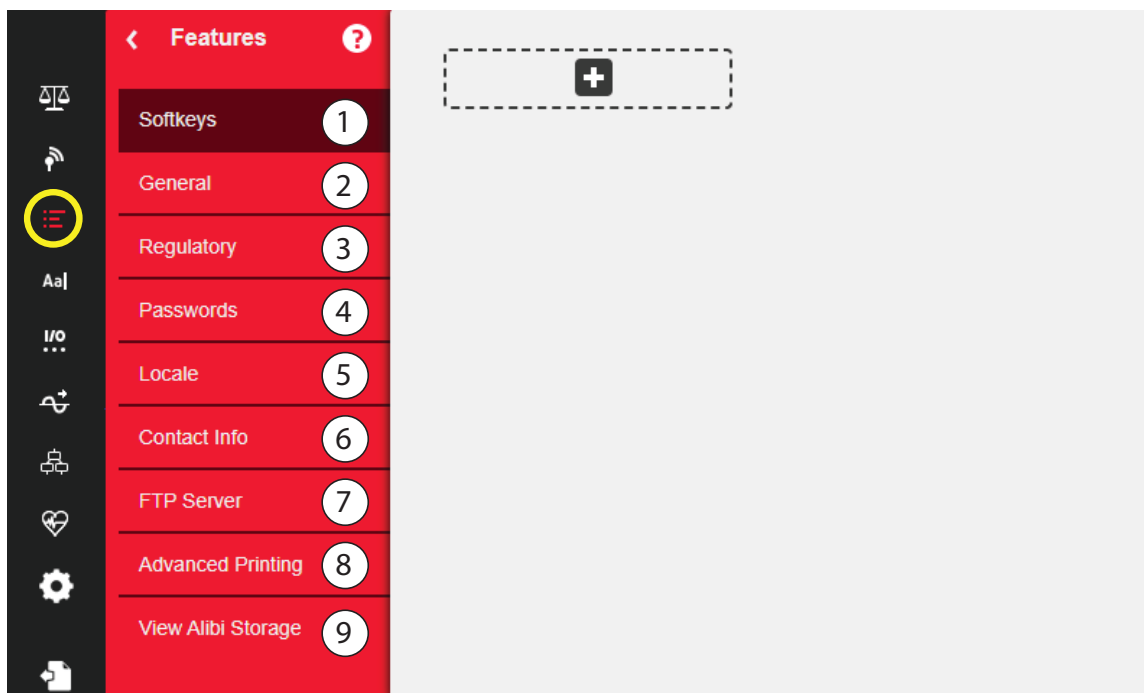



Figure 6-1. Features Menu

Item No.	Parameter	Description
1	Softkeys	Softkeys setup, see <a href="#">Section 6.1 on page 82</a>
2	General	Setup general indicator settings, see <a href="#">Section 6.2 on page 84</a>
3	Regulatory	Allows for the selection of the regulatory mode required for the scale, see <a href="#">Section 6.3 on page 85</a>
4	Passwords	Allows passwords to be set to secure menus, see <a href="#">Section 6.4 on page 88</a>
5	Locale	Allows the local language, time/date and decimal format to be setup, see <a href="#">Section 6.5 on page 88</a>
6	Contact Info	Allows the input of company information, see <a href="#">Section 6.6 on page 89</a>
7	FTP Server	Allows for transfer of data to and from the 1280 in iRite, see <a href="#">Section 6.7 on page 89</a>
8	Advanced Printing	Setup printing using optional printers over network/USB, see <a href="#">Section 6.8 on page 90</a>
9	View Alibi Storage	Provides past transactions and allows past transactions to be reprinted, see <a href="#">Section 6.9 on page 91</a>

Table 6-1. Features Menu Parameters



## 6.1 Softkeys

Softkeys are available to provide additional operator functions for specific applications. When enabled they are displayed as digital buttons at the bottom of the display in weigh mode. Press a softkey to use the assigned functions.

To enter the **Softkey** menu, press  and select **Softkeys**.

When the **Auto-Populate Softkey** is set to on, the default or the last set softkeys display, see [Section 6.1.2](#).

### 6.1.1 Enable/Disable Softkeys

1. Press  to view the list of predefined softkeys, see [Section 6.1.2](#).
2. Select from the list of predefined softkeys or one of the user defined options.
3. Select  to enable the softkey or press cancel to quit.

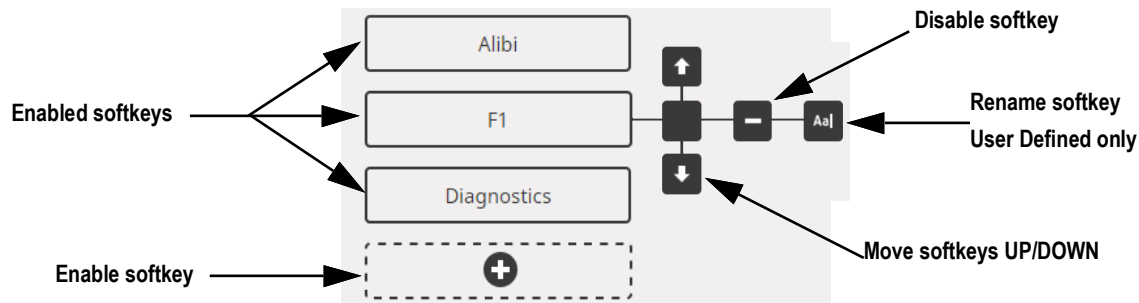

Figure 6-2. Enable/Disable Softkeys

### 6.1.2 Predefined Softkeys

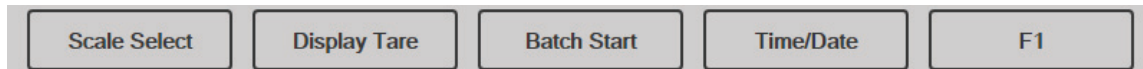

Figure 6-3. Example Softkeys

Softkey	Description
Blank	No softkey available
User Defined 1–10	Up to 10 softkeys can be created using one of the user defined options (22 characters or less available)
Time/Date	Displays current time and date; allows time and date change
Display Tare	Displays tare value in the entry prompt
Display Accumulator	Displays accumulator value, if enabled, for the current scale
Display Rate of Change	Displays rate-of-change value, if enabled, for the current scale
Setpoint	Displays a menu of configured setpoints; allows display and change of some setpoint parameters
Batch Start	Starts a batch from the current step if a Batch Run digital input is either active or not defined; if a Batch Run digital input is defined and inactive, Batch Start resets the batch to the first step
Batch Stop	Stops an active batch and turns off all associated digital outputs; requires a Batch Start to resume processing
Batch Pause	Pauses an active batch and turns off all digital outputs except those associated with Concurrent and Timer setpoints; processing is suspended until the indicator receives a Batch Start signal; pressing the BATSTRT digital input, BATSTART serial command, Batch Start softkey or the StartBatch function (in iRite) resumes the batch and re-energizes all digital outputs turned off by the Batch Pause
Batch Reset	Stops an active batch and resets the current step to the first batch step; all digital outputs associated with batch setpoints are deactivated; if a batch is stopped or paused, Batch Reset resets the current step to the first step
Select Scale	Enter the scale number (using the numeric keypad) to be displayed for multi-scale applications, followed by the select scale softkey
Diagnostics	Opens the iQUBE <sup>2</sup> diagnostics screen
Alibi	Allows previous print transactions to be recalled and reprinted
Contrast	Adjusts the screen backlight intensity
Test	Not available in version 1.00

Table 6-2. Configurable Softkeys

Softkey	Description
Stop	Sends AuxFmt13 out its configured port to display a red light on a LaserLight
Go	Sends AuxFmt12 out its configured port to display a green light on a LaserLight
Off	Sends AuxFmt14 out its configured port to turn a LaserLight red/green light off
Display Unit ID	Displays the Unit ID in the lower left corner of the screen
Zero	Zeros the indicator
Gross/Net	Toggles between gross and net modes
Tare	Tare the scale using the on-screen numeric keypad
Keyed Tare	Tare the scale using the on-screen numeric keypad
Units	Toggles between primary, secondary and tertiary units
Print	Prints the configured print format
Aux Print	Auxiliary printing by entering the Auxiliary Format number (1–20) using on-screen numeric keypad
Screen	Display a different screen by entering a value (1–99) and press the Screen softkey
Database	Accesses the import and export database feature from the weigh mode

Table 6-2. Configurable Softkeys (Continued)



**NOTE:** The Zero, Gross/Net, Tare, Units and Print softkeys are functionally equivalent to the keypad function keys. These softkeys are primarily for web browser remote connections, when a physical keypad is not available.

### 6.1.3 Database Softkey

The **Database** softkey must be configured to use the Database Import/Export functionality from weigh mode.

To access the database import or export features from the weigh mode:

1. Select the **Database** softkey. The database menu displays for several seconds.



Figure 6-4. Database Screen in Weigh Mode

2. Select either **Import Database** or **Export Database**. The Import/Export screen displays, see [Section 14.3 on page 128](#) or [Section 14.5 on page 129](#) to complete the database import/export.

### 6.1.4 LaserLight Softkey

User must configure 1280 softkeys to use Stop/Go, see [Table 6-3](#) to view the pre-populated commands in the print formats.



Figure 6-5. LaserLight Softkey Example

[Table 6-3](#) lists commands to display the Stop, Go (circle or arrow) and Off elements on a LaserLight. The command information can be changed. The softkey is coded to send the associated AuxFmt.

Traffic Light State	AuxFmt	Serial Command
Stop	AuxFmt13	00D03!
Green Circle	AuxFmt12	00D02!
Green Arrow	AuxFmt12	00D01!
Off	AuxFmt14	00D00!

Table 6-3. LaserLight2 Commands

## 6.2 General Parameters

To enter the **General** menu, press  and select **General**.

1. Press the parameter to be set.
2. If the setting needs data entry, a keypad displays. Enter data and press .

Parameter	Default	Description
Unit Id	1	Specifies the unit identification number with an alphanumeric value (up to eight characters)
Consecutive Number	0	Value is incremented following each print operation includes <CN> in the ticket format; when reset, it is set to a value specified in the Consecutive Numbering Start parameter (up to seven characters)
Consecutive Number Start	0	Start value of the next print when it is reset; range is from 0–9999999 (up to seven characters) <i>Example: If set to 0, the next print is 1. If set to 47, the next print is 48.</i>
Full Keyboard Lock	Off	Locks entire keyboard if turned on
Virtual Keypad Lock	Off	When off, the virtual on-screen keypad closes when any of the buttons is activated automatically; when on, the keypad remains in place, but can be closed manually
Zero Enabled Keyboard Lock	Off	Locks keyboard except zero key if turned on
Auto-Populate Softkeys	Off	When on, all screens are automatically populated with softkeys at the bottom of the screen; when off, the user can place a softkey widget anywhere on the screen
Local/Remote Server Address	127.0.0.1	Specifies the IP address of the remote indicator; to display the local indicator, set to the local host address of 127.0.0.1; if a local/remote application, set this parameter, on the remote indicator only, to the IP address of the local indicator to use its display

Table 6-4. General Parameters Menu

### 6.2.1 Local/Remote Operation

Local/remote support provides a function equivalent to the indicator via web server with network access. The display on the local indicator is also displayed at the remote unit, and keypad input from the remote unit is treated the same as keypad input on the local indicator.

1. Connect both indicators to the same Ethernet TCP/IP or Wi-Fi network.
2. Look up the local indicator's IP address by pressing the Wi-Fi symbol in Weigh mode (to bring up the Network Information screen), or look it up under the **Communications** menu in Configuration mode.
3. On the remote indicator, use the **Features/General** menu to change the Local/Remote Server Address to the IP address of the local indicator.
4. When in weigh mode, the remote displays a copy of the local indicator's display. Key presses on the remote indicator are passed back to the local to perform their intended function.



**NOTE: It is recommended to use static IP addresses (set DHCP to Off) when using the local/remote feature, to avoid connection issues.**

**For an indicator to provide its own display, the Local/Remote Server Address must be set to 127.0.0.1. The display is treated as a remote if any other IP address is entered.**

**If the configuration switch is pressed on the remote indicator, the remotes configuration menu displays on the remote only. If the configuration switch is pressed on the local indicator, the locals configuration menu displays on both indicators.**

**If the local indicator goes off-line, the remote indicator's display is blank or has dashes for the weight.**

**The remote indicator can only provide the local display and return key/virtual keypad presses. Weight data is not available at the remote indicator for functions such as printing, serial data streaming or setpoints.**

### Using an Internet Browser as a Remote Display

A virtual display can be viewed on a computer or mobile device using an Internet browser which supports HTML 5 and Javascript, such as Internet Explorer v10 and newer, Chrome v30 and newer or Firefox v32 and newer. In addition to viewing, virtual keypad elements can be activated by clicking on them in the browser window.



To use this feature, the 1280 and computer/mobile device must be connected to the same network. In the browser's address bar (URL), type the IP address of the 1280, using TCP port 3000.

*Example: If the 1280's IP address is 192.168.0.1 then navigate the browser to <http://192.168.0.1:3000>.*

## 6.3 Regulatory

Specifies the regulatory agency having jurisdiction over the scale site. Regulatory agencies regulate legal metrology procedures for each countries scale performance.

The selection made for this parameter affects the function of the front panel **Tare** and **Zero** keys. **Tare** and **Zero** key functions are also configurable when the **Regulatory** mode is set to Industrial to accommodate operations which may not be covered specifically by the general regulatory selections.

1. Press  **Features** and then press **Regulatory**.
2. Press **Regulatory Mode**. The Regulatory Mode options menu displays:
  - National Type Evaluation Program (NTEP)
  - International Organization of Legal Metrology (OIML)
  - Measurement Canada
  - Industrial Mode ([Table 6-7 on page 87](#))
  - Australia
  - None
3. Select the required mode.
4. Press .

## Parameters Available in all Regulatory Modes

Parameters	Default	Description
Alibi Storage	Off	Allows previous print transactions to be recalled and reprinted if enabled
Gravity Compensation	Off	Scales must be re-calibrated after changing from Off to On; specifying the latitude and elevation of the calibration and scale sites provides compensation for gravitational effects; to calibrate with gravity compensation, Origin Latitude and Elevation and Destination Latitude and Elevation must be set
Origin Latitude	45	Origin latitude of the scale site in degrees, range 0–90 (only available with Gravity Compensation set to On)
Origin Elevation (meters)	345	Origin Elevation of the scale site in meters, range -9999–9999 (only available with Gravity Compensation set to On)
Destination Latitude	45	Destination latitude of the scale site in degrees, range 0–90 (only available with Gravity Compensation set to On)
Destination Elevation (meters)	345	Destination Elevation of the scale site in meters, range -9999–9999 (only available with Gravity Compensation set to On)
Monorail Mode	Off	Allows preset (keyed) tare values to be of higher precision than the display division size in Monorail applications
Enable Screen Saver	Off	Enables screen saver functionality; screen saver can be triggered by the Screen Saver Weight Threshold or the Screen Saver Activation Time; when the screen saver is triggered, the backlight dims to 10%
Screen Saver Weight Threshold	0	The screen saver activates when the weight dips below the Screen Saver Weight Threshold (only available when Enable Screen Saver is set to On)
Screen Saver Activation Time	30	Standstill time at which the screen saver activates (only available when Enable Screen Saver is set to On)

Table 6-5. Regulatory Mode Parameters – All Modes

Table 6-6 describes the function of **TARE** and **ZERO** for the NTEP, OIML, Measurement Canada, Australia and None regulatory modes.

Regulatory Parameter Value	Weight on Scale	Tare in System	Front Panel Key Function	
			Tare	Zero
NTEP	Zero or negative	No	No action	Zero
		Yes	Clear Tare	
	Positive	No	Tare	
		Yes	Tare	
OIML	Zero or negative	No	No action	Zero
		Yes	Clear Tare	Zero and Clear Tare
	Positive	No	Tare	Zero
		Yes	Tare	Zero and Clear Tare if weight is within ZRANGE; no action if weight is outside of ZRANGE
Measurement Canada	Zero or negative	No	No action	Zero
		Yes	Clear Tare	
	Positive	No	Tare	
		Yes	No action	
Australia	Zero or negative	No	No action	Zero
		Yes	Clear Tare	Zero and Clear Tare
	Positive	No	Tare	Zero
		Yes	Tare	Zero and Clear Tare if weight is within ZRANGE; no action if weight is outside of ZRANGE
NOTE: The scale widget does not display capacity and count-by when the Regulatory Mode is set to Australia.				
NONE	Zero or negative	No	Tare	Zero
		Yes	Clear Tare	
	Positive	No	Tare	
		Yes	Clear Tare	
Industrial Mode	See Table 6-7 on page 87			

Table 6-6. Tare/Zero Key Functions for Regulatory Parameter Settings

## Industrial Mode Parameters



Industrial mode provides a set of sub-parameters to allow customization of tare, clear and print functions in non-Legal for Trade scale installations.

Parameter	Default	Description
Audit Agency	NTEP	Defines how the Audit Trail data is displayed/printed, depending on the requirements for the various regulatory agencies
Weight Source for Print	Synchronized to Display	Synchronized to the displayed value or the scale internal value
Allow Tare in Display Hold	Off	A semiautomatic (push-button) tare which can be taken while the scale display is being held
Allow Print in Display Hold	Off	A demand print may be performed while the scale display is being held
Remove Tare on Zero	Off	A tare is removed if a semiautomatic (push-button) zero is performed on the scale
Always Allow Keyed Tare	On	Preset (keyed) tares are allowed at any weight, not just at zero gross
Multiple Tare Action	Replace	Defines the resulting action if a semiautomatic (push-button) tare is attempted while there is already a tare for the scale <ul style="list-style-type: none"> <li>• <b>Replace</b> - replaces the current tare with the new one</li> <li>• <b>Remove</b> - clears the current tare</li> <li>• <b>No Action</b> - rejects the new tare attempt (the current tare must be cleared before a new tare can be acquired)</li> </ul>
Allow Negative Tare	Off	Allows a semiautomatic (push-button) tare to be taken at a negative gross weight, resulting in a negative tare weight
Allow CLR key to clear tare/accumulator	On	Allows the <b>Clear</b> key to clear the tare or accumulator while the tare or accumulator is being displayed
Clear Source Scales Individually	Off	Allows the clearing of tare values from source scales individually when a total scale is involved
Allow Total Scale to Display Negative	Off	Allows the total scale to display a negative value, otherwise the total scale displays an error whenever any source scale is displaying a negative value
Allow Print in Motion	Off	Allows a demand print to be performed while the scale is in motion
Allow PT to Keyed Tare Print	Off	The letters <b>PT</b> display on printed output if the tare value is a preset or keyed tare
Zero Base for Overload	Calibrated Zero	Used to determine the point at which the scale displays an overload, either (calibrated zero + capacity + overload setting) or (current captured zero + capacity + overload setting)
Use Fine Push-Button Tare	Off	When a semiautomatic (push-button) tare is taken, use internal counts instead of the rounded display value
Use Fine Keyed Tare	Off	When a preset, or keyed tare is entered, use the exact value entered instead of rounding the value to the current display division
Tare in Motion	Off	Allow a semiautomatic (push-button) tare to be taken while the scale is in motion
Zero in Motion	Off	Allow a semiautomatic (push-button) zero to be performed while the scale is in motion
Underload Limit (Display Divisions)	9999999	Defines the number of display divisions below gross zero which is displayed before the scale displays an underload condition
Allow Manual Clear Tare	On	Allows the clearing of the tare value manually at any gross weight
Auto-Zero Tracking on Net Zero	Off	Allows the scale zero to be automatically adjusted, within the specified zero range, to track a net zero display
Display Capacity on Scale Widget	On	Allows the scale widget to display the capacity of the scale
Display Count-by on Scale Widget	On	Allows the scale widget to display the count-by of the scale

Table 6-7. Industrial Mode Parameters

## 6.4 Passwords

Passwords can be set to secure the Configuration, Setpoints and Calibration menus.



1. Ensure the audit jumper (JP1) is in the **On** position in order to turn on the passwords, see [Figure 3-3 on page 58](#).
2. Press  then press **Passwords**.
3. Select the **Configuration**, **Setpoints** or **Calibration**. The keyboard displays.
4. Enter the password then press .

Parameters	Parameter
Configuration Password	Allows the configuration parameters to be accessed without the need to press the configuration button
Setpoints Password	Allows the Enable and Value setpoint parameters to be accessed without the need to press the configuration button
Calibration Password	Allows the calibration parameters to be accessed without the need to press the configuration button

Table 6-8. Menu Passwords

## 6.5 Locale

Select this parameter to set the desired language, date and time formats, and decimal format.

1. Press  then press **Locale**.
2. Press the parameter to set.
3. Select the setting desired.
4. Press .

Parameter	Default	Description
Default Weigh Mode Language	English	Select from 16 languages available for the indicator weigh mode, see <a href="#">Section</a> ; indicator must be rebooted for change to take affect
Date Format	MMDDYYYY	Select one of the four formats available: MMDDYYYY, DDMMYYYY, YYYYMMDD, YYYYDDMM
Date Separator	Slash (/)	Select one of three date separators available, Slash (/), Dash (-), Semi-colon (;)
Time Format	12 Hour	Select 12-hour or 24-hour time format
Time Separator	Colon (:)	Select Colon (:) or Comma (,) as the time separator
Decimal Format	Dot (.)	Select Dot (.) or Comma (,) as the format for the decimal
Time/Date Change Restriction	Off	Returns current status, only works in setup mode; ON/OFF

Table 6-9. Locale Parameters Menu

### Default Weigh Mode Languages



There are 16 languages available for the indicator weigh mode.

- English
- Spanish
- French
- Portuguese
- Italian
- German
- Dutch
- Danish
- Swedish
- Russian
- Ukrainian
- Hebrew
- Arabic
- Thai
- Chinese
- Turkish



## 6.6 Contact Info

Enter the Contact Info menu to setup company information.

1. Press , select **Contact Info**.
2. Press the parameter to be set. A keyboard displays.
3. Enter the information and press .
4. Repeat [Step 1](#) and [Step 2](#) until all desired entries have been made.

Parameter	Description
Company Name	Enter the company name (up to 30 characters)
Address Line 1–3	Enter the address, three lines available (up to 30 characters per line)
Contact Name 1–3	Enter up to three contact names (up to 20 characters per contact)
Contact Phone 1–3	Enter up to three contact phone Numbers (up to 20 characters per phone number)
Email Address	Enter an email address (up to 30 characters)
Next Calibration Date	Specify the next calibration date
Last Calibration Date	Specify the last calibration date

Table 6-10. Contact Info Parameters

## 6.7 FTP Server

### 6.7.1 Set FTP Server Password

Follow the steps below to set up a password for an FTP server:

 **NOTE:** FTP user name is “ftpuser.”

1. Press , select **FTP Server**.
2. Set **FTP Server Access Enabled** to **On** or **Off**.
3. Press **FTP Server Password** to set a Password for the FTP server. User name is “ftpuser.” User name can not be changed.

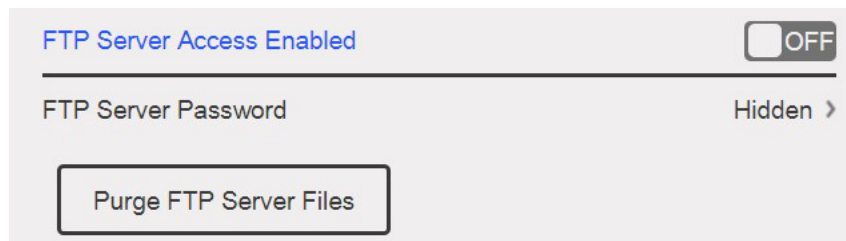



Figure 6-6. FTP Server Menu

 **NOTE:** FTP password must be set for the FTP Server to operate. A blank password is not valid.  
Press **Purge FTP Server Files** to delete all of the files in the FTP Server “files” directory at once. Files can be removed one at a time with the FTP “delete <file name>” command.

## 6.7.2 Initialize FTP Server

The FTP server is started and stopped via iRite APIs. See iRite Programming Manual PN67888 for more information on using iRite APIs. Once the FTP Server has been started, its directory and files can be accessed externally using various tools either automated or manually.

1. Start FTP server using StartFTPServer API command via iRite.
2. Access FTP directory through desired FTP tool. Adapt the following information as needed for connection method:
  - Command prompt ftp <ip address of 1280>
  - Name prompt ftpuser
  - Password prompt <password created in [Section 6.7.1 on page 89](#)>
  - ftp prompt cd files - location of stored data in 1280
  - ftp prompt dir - displays contents of directory



**NOTE: Directory (cd) must be changed to the directory named “files” when connected. This folder is where the data is stored and cannot be changed. Subdirectories within ‘files’ may be created as needed.**

3. Send and receive data in the “files” directory using the commands put and get or using desired FTP tool.
4. Stop FTP connection using StopFTPServer API command via iRite.



**NOTE: Entering setup/configuration will STOP the FTP server. iRite program must restart FTP server when returning to setup/configuration**

## 6.8 Advanced Printing

Allows printing from network/USB sources or by using iRite.



**NOTE: Enabling USB and advanced printing simultaneously is now supported. This is useful if both local and network printers are used.**

Figure 6-7. Advanced Printer Setup Menu

1. Press  to enter the printer setup wizard.
2. Select the manufacturer of the printer from the list. Use the scroll bar to view all selections. With the manufacturer selected, press .
3. Using the same process as [Step 2](#), select the Model of the printer.
4. Select the connection type to be used to connect to the printer, network or USB.
5. If using a network connection, enter the **Network URL**.



**NOTE: The 1280 supports Direct Print and Internet Printing Protocol for printing directly to a printer. URL examples include: socket://<ip-address-of printer>:9100 ipp://<ip-address-of-printer>:631.**

6. Press  to complete the setup. **Printer successful installed** displays.



## 6.9 View Alibi Storage

Allows previous print transactions to be recalled and reprinted. Approximately 500,000 alibi records can be stored.



**NOTE:** Set the Alibi Storage to On by entering the regulatory menu under features, see [Section on page 86](#).

**External Alibi storage is not supported.**

1. Press , then press **View Alibi Storage**.
2. Use the arrows to scroll to the page containing the record needed. Alternatively, enter the date range to search for the record.
3. Press the desired record to select it.
4. To print the currently selected record, press **Reprint**.
5. Repeat [Step 2](#) through [Step 4](#) until all records required have been printed.
6. When all records required have been printed, press .

A demand print string is stored in Alibi memory and is assigned an ID number. The token <AN> for the Alibi ID number should be added to the print strings for reference.

The data stored in the record is dependent upon the ticket format, see [Section 7.0 on page 92](#) to format a ticket to contain the tokens for weight, date and time, scale number, alibi ID.

To delete the oldest 50% of alibi storage, Press **Purge Oldest**. Every time that Purge Oldest is pushed, the alibi storage will decrease by 50% until there are no more records.

### Checksum

The print string is stored with a Checksum to ensure data integrity. The checksum is calculated when the weighment is stored in alibi storage. When the data is retrieved, the checksum is re-calculated and compared to the stored value. If the values match, the data is transmitted. If the values do not match, the 1280 displays **Invalid Record**.

The checksum is for internal use only and not retrievable.

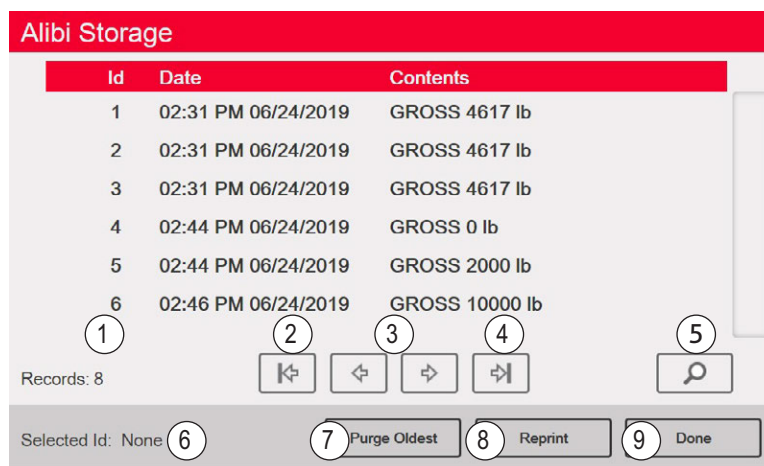

Figure 6-8. Alibi Storage Screen

Item No.	Description
1	Records – total number of stored records
2	Page to beginning
3	Page left or right
4	Page to the end
5	Search by date
6	Selected Id for current record
7	Purge Oldest 50% of records
8	Reprint current record
9	Done – press to return to previous menu

Table 6-11. Alibi Storage

## 7.0 Formats

The Format menu allows the setup of print and stream formats.

From the Configuration menu, select **Aa|** (circled in [Figure 7-1](#)) to enter the Formats menu.

Once all parameters have been set, select  to return to weigh mode.

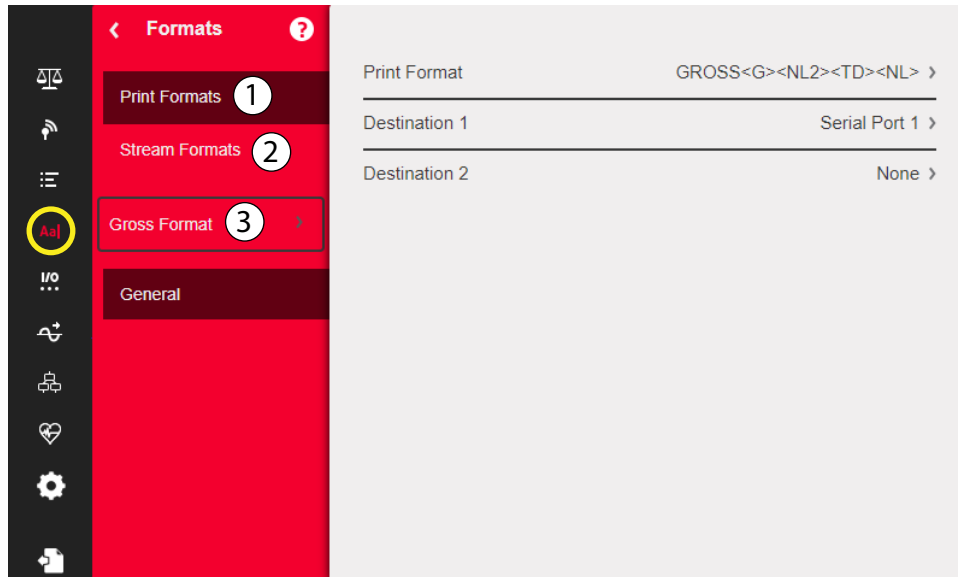

Figure 7-1. Format Menu

Item No.	Parameter	Description
1	Print Formats	Used to set the printed output when the Print key is pressed, a KPRINT command is received or when the setpoint push-print or truck weigh-in/weigh-out operations are performed, see <a href="#">Section 7.1 on page 93</a>
2	Stream Formats	The 1280 supports four configurable data streaming formats (Stream Format 1-4). Each stream format can be set to one of the pre-configured formats or a custom format can be created, see <a href="#">Table 7-5 on page 96</a> .
3	Selection Field	Allows selection of print or stream formats

Table 7-1. Format Menu Parameters

## 7.1 Print Format

The print format used for a given print operation depends on the indicator configuration and the operation performed. Each print format can be customized to include up to 1000 characters of information, such as company name and address, on printed tickets.

Use the Revolution configuration utility, serial commands or the indicator front panel to customize the print formats.

1. Press **Aa|** then select **Print Format**.

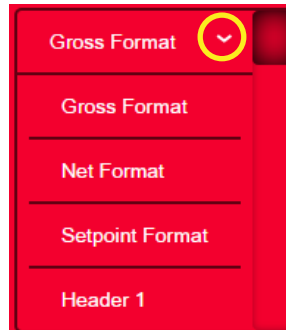

Figure 7-2. Select Format

2. Press the selection field arrow to select the print format to be configured. The current settings for which format displays to the right.
3. Press the format to be edited. The format editor displays, see [Table 7-4 on page 94](#) for a list of print tokens, which are always enclosed in < >. Characters not enclosed in < > are printed as displayed.
4. Press **Done** when finished editing.
5. Set the communications port destination parameters as needed, see [Section 7.1.2 on page 94](#).

### 7.1.1 Default Print Formats

These are the formats used when the indicator's configuration is reset.

Print Format	Default Format
Gross Format	GROSS<G><NL2><TD><NL>
Net Format	GROSS<G><NL>TARE<SP><T><NL>NET<SP2><N><NL2><TD><NL>
Setpoint Format	<SCV><SP><SPM><NL>
Header 1	COMPANY NAME<NL>STREET ADDRESS<NL>CITY, ST ZIP<NL2>
Header 2	COMPANY NAME<NL>STREET ADDRESS<NL>CITY, ST ZIP<NL2>
Accumulator Format	ACCUM <A><NL><DA> <TI><NL>
Alert Format	<COMP><NL><COAR1><NL><COAR2><NL><COAR3><NL><CONM1><COPH1><NL><CONM2> <COPH2><NL><CONM3> <COPH3><NL><COML><NL><ERR><NL>
Audit Trail Format	--
Auxiliary Format 1–20	GROSS<G><NL2><TD><NL> <b>NOTE: AuxFmt12, AuxFmt13 and AuxFmt14 are specified for the LaserLight only.</b>

Table 7-2. Default Print Formats

### 7.1.2 Print Format Destination Ports

A print format can be configured to simultaneously transmit its data on two communication ports.

1. Press **Destination 1** and select the communication port to be used.
2. Repeat for **Destination 2** (optional).

Menu Option	Description
None	This destination (1 or 2) will not transmit print format data
Basic USB Printer	Supports only a single printer which uses only ASCII characters
Advanced Printer	Supports wide range of commercial printers and languages
Email	Sends print format data via email (See <a href="#">Section 12.2 on page 120</a> for setup information)
Serial Port 1	Sends print format data via RS-232, RS-422 and RS-485 on J6 (See <a href="#">Section 5.1 on page 74</a> for setup information)
Serial Port 2	Sends print format data via RS-232, RS-422 and RS-485 on J7 (See <a href="#">Section 5.1 on page 74</a> for setup information)
TCP Client 1	Sends print format data via TCP (See <a href="#">Section 5.2.8 on page 79</a> for setup information)
TCP Client 2	Sends print format data via TCP (See <a href="#">Section 5.2.8 on page 79</a> for setup information)
TCP Client 3	Sends print format data via TCP (See <a href="#">Section 5.2.8 on page 79</a> for setup information)
Serial Ports 5-16	When option card is installed, ports 5-16 send print format data via RS-232, RS-422 and RS-485 (See <a href="#">Section 5.1 on page 74</a> for setup information)

Table 7-3. Destination Options

### 7.1.3 Print Format Tokens

Token	Description	Supported Ticket Formats
<i>General Weight Data Tokens</i>		
<G>	Gross weight, current scale	SPFMT, GFMT, NFMT, ACCFMT, AUXFMTxx, ALERT
<G#n>	Gross weight, scale <i>n</i>	
<N>	Net weight, current scale	
<N#n>	Net weight, scale <i>n</i>	
<T>	Tare weight, current scale	
<T#n>	Tare weight, scale <i>n</i>	
<S>	Current scale number	
<p><b>NOTE: Gross, net and tare weights can be printed in any configured weight unit by adding the following modifiers to the gross, net, and tare weight tokens: /P (primary units), /D (displayed units), /S (secondary units) or /T (tertiary units). If not specified, the currently displayed unit (/D) is assumed.</b></p> <p><i>Example: To format a ticket to provide net weight for Scale 3 in secondary units, use the following token: &lt;N#3/S&gt;</i></p> <p><b>NOTE: Formatted weight strings contain a 9-digit weight field (including sign and decimal point, with leading zeros suppressed), followed by a space and a two-digit unit identifier. Total field length with units identifier is 12 characters.</b></p>		
<i>Accumulator Tokens</i>		
<A>	Accumulated weight, current scale; Prints to 15 digits	GFMT, NFMT, ACCFMT, AUXFMTxx
<A#n>	Accumulated weight, scale <i>n</i>	
<AA>	Average accumulation, current scale	
<AA#n>	Average accumulation, scale <i>n</i>	
<AC>	Number of accumulations, current scale	
<AC#n>	Number of accumulations, scale <i>n</i>	
<AT>	Time of last accumulation, current scale	
<AT#n>	Time of last accumulation, scale <i>n</i>	
<AD>	Date of last accumulation, current scale	
<AD#n>	Date of last accumulation, scale <i>n</i>	

Table 7-4. Print Format Tokens

Token	Description	Supported Ticket Formats
<i>Setpoint Tokens</i>		
<SCV>	Setpoint captured value	SPFMT
<SN>	Setpoint number	
<SNA>	Setpoint name	
<SPM>	Setpoint mode (gross or net label)	
<SPV>	Setpoint preact value	
<STV>	Setpoint target value	
<i>Auditing Tokens</i>		
<CD>	Last calibration date	All
<NOC>	Number of calibrations	
<NOW>	Number of weighments since last calibration	
<b>NOTE: Last calibration date (&lt;CD&gt;) and number of calibrations (&lt;NOC&gt;) are updated anytime a calibration is performed on any of the scales. Number of weighments (&lt;NOW&gt; token) is incremented whenever the scale weight exceeds 10% of scale capacity. Scale must return to gross or net zero before the value can be incremented again.</b>		
<i>Formatting and General-Purpose Tokens</i>		
<nnn>	ASCII character ( <i>nnn</i> = decimal value of ASCII character); used for inserting control characters (STX, for example) in the print stream	All
<Ti>	Time	
<DA>	Date	
<TD>	Time and date	
<UID>	Unit ID number (up to 8 alphanumeric characters)	
<CN>	Consecutive number (up to 7 digits)	
<H1>	Insert header format 1 (HDRFMT1), see <a href="#">Table 7-2 on page 93</a>	
<H2>	Insert header format 2 (HDRFMT2), see <a href="#">Table 7-2 on page 93</a>	
<CR>	Carriage return character	
<LF>	Line feed character	
<NL <i>nn</i> >	New line ( <i>nn</i> = number of termination (<CR/LF> or <CR>) characters)*	
<SP <i>nn</i> >	Space ( <i>nn</i> = number of spaces)*	
<SU>	Toggle weight data format (formatted/unformatted)	
<b>NOTE: If <i>nn</i> is not specified, 1 is assumed. Value must be in the range 1–99.</b>		
<i>User Program-dependent Tokens</i>		
<US <i>nn</i> >	Insert user print text string (from user program, SetPrintText API)	All
<EV <i>x</i> >	Invoke user program print handler <i>x</i> (PrintFmt <i>x</i> )	AUXFMT <i>x</i>
<AN>	Enables the addition of an Allibi ticket number	All
<i>Alert Format Tokens</i>		
<COMP>	Company name (up to 30 characters)	All
<COAR1>	Contact company address, lines 1–3 (up to 30 characters)	
<COAR2>		
<COAR3>		
<CONM1>	Contact names (up to 20 characters)	
<CONM2>		
<CONM3>		
<COPH1>	Contact phone numbers (up to 20 characters)	
<COPH2>		
<COPH3>		
<COML>	Contact e-mail address (up to 30 characters)	
<ERR>	Alert error message (system-generated)	ALERT

Table 7-4. Print Format Tokens (Continued)

## 7.2 Stream Format Menu

The four stream formats can each be sent out of one or more of the indicator's communications ports.

Parameters	Default	Description
Output Stream Type	Off	Select Legal for Trade (stream data updates at the display update rate), Industrial (stream data updates up to the scale sample rate) or Off (disables the stream format); if Legal for Trade or Industrial is selected, parameters Stream Source and Stream Destinations display
Stream Source	None	The scale the weight data is taken from
Stream Destinations	None	Defines the communication ports the stream data is sent to (more than one can be selected)
Stream Format	RLWS/Condec	Specifies the format of the stream frame; select one of the available default formats, or custom and use the Custom Format parameter to build a stream frame; if Custom is selected, the following parameters (in blue) display
Custom Format	<2><P><W7.> <U><M><S>	Used to define a custom stream frame format, if the stream format parameter is set to custom
Gross Token	G	Defines what is sent in the data frame for the Mode Token when in Gross mode (up to eight characters)
Tare Token	T	Defines what is sent in the data frame for the Mode Token when in Tare mode (up to eight characters)
Net Token	N	Defines what is sent in the data frame for the Mode Token when in Net mode (up to eight characters)
Positive Token	Space	From a list, select the character which is sent in the data frame for the Polarity Token when displaying a positive weight; the default is a blank space
Negative Token	Minus	Defines the character which is sent in the data frame for the Polarity Token when displaying a negative weight
Primary Token	L	Defines what is sent in the data frame for the Units Token when displaying Primary units (up to eight characters)
Secondary Token	K	Defines what is sent in the data frame for the Units Token when displaying Secondary units (up to eight characters)
Tertiary Token	K	Defines what is sent in the data frame for the Units Token when displaying Tertiary units (up to eight characters)
Zero Token	Z	Defines what is sent in the data frame for the Status Token when weight is at Center of Zero (up to two characters)
Motion Token	M	Defines what is sent in the data frame for the Status Token when weight is in Motion (up to two characters)
Range Token	O	Defines what is sent in the data frame for the Status Token when weight is Out of Range (up to two characters)
OK Token	[blank entry]	Defines what is sent in the data frame for the Status Token when weight is OK (or not in one of the other states) (up to two characters); default is a blank space
Invalid Token	I	Defines what is sent in the data frame for the Status Token when weight is Invalid (up to two characters)

Table 7-5. Stream Format Parameters

### Stream Format

To set up the stream formats using the indicator front panel:

1. Press **Aa|** then select **Stream Format**, see [Figure 7-1 on page 92](#).
2. Press **Stream Format 3** to select the format to be configured.
3. Press **Output Stream Type** to set Industrial or Legal for Trade.
4. Press **Done**.
5. Press **Stream Source** to set one of the eight scales for the format.
6. Press **Stream Format** to choose the format to be used and press **Done**.
7. If **Custom Format** was selected in [Step 6](#), press select **Custom Format**. The **Custom Format** keypad displays. Stream tokens are listed in [Table 7-6 on page 97](#). Press **Done**.
8. Press **Stream Destinations** to indicate where to stream.
9. Press **Done**.
10. Set the values for the Stream Tokens as needed, see [Table 7-5](#).



### 7.2.1 Stream Format Tokens

Format Identifier	Defined By	Description
<P[G   N   T]>	STRM.POS#n STRM.NEG#n	Polarity – specifies positive or negative polarity for the current or specified (Gross/Net/Tare) weight on the source scale. Possible values are SPACE, NONE, + (for STR.POS#n) or – (for STR.NEG#n)
<U[P   S   T]>	STRM.PRI#n STRM.SEC#n STRM.TER#n	Units – specifies primary, secondary or tertiary units for the current or specified weight on the source scale
<M[G   N   T]>	STRM.GROSS#n STRM.NET#n STRM.TARE#n	Mode – specifies gross, net or tare weight for the current or specified weight on the source scale
<S>	STRM.MOTION#n STRM.RANGE#n STRM.OK#n STRM.INVALID#n STRM.ZERO#n	Status for the source scale – default values and meanings for each status: <ul style="list-style-type: none"> <li>• STR.MOTION#n M In motion</li> <li>• STR.RANGE#n O Out of range</li> <li>• STR.OK#n &lt;space&gt; OK</li> <li>• STR.INVALID#n I Invalid</li> <li>• STR.ZERO#n Z COZ</li> </ul>
<B [-]n,...>	See descriptions below	Bit fields. Comma-separated sequence of bit field specifiers; must be exactly 8-bits; minus sign ([-]) inverts the bit
B0	--	Always 0
B1	--	Always 1
B2	Configuration	=1 if even parity
B3	Dynamic	=1 if MODE=NET
B4	Dynamic	=1 if COZ
B5	Dynamic	=1 if standstill
B6	Dynamic	=1 if gross negative
B7	Dynamic	=1 if out of range
B8	Dynamic	=1 if secondary/tertiary
B9	Dynamic	=1 if tare in system
B10	Dynamic	=1 if tare is keyed
B11	Dynamic	=00 if MODE=GROSS =01 if MODE=NET =10 if MODE=TARE =11 (not used)
B12	Dynamic	=00 if UNITS=PRIMARY =01 if UNITS=SECONDARY =10 if UNITS=TERTIARY =11 (not used)
B13	Configuration	=00 (not used) =01 if current DSPDIV=1 =10 if current DSPDIV=2 =11 if current DSPDIV=5
B14	Configuration	=00 (not used) =01 if primary DSPDIV=1 =10 if primary DSPDIV=2 =11 if primary DSPDIV=5
B15	Configuration	=00 (not used) =01 if secondary DSPDIV=1 =10 if secondary DSPDIV=2 =11 if secondary DSPDIV=5
B16	Configuration	=00 (not used) =01 if tertiary DSPDIV=1 =10 if tertiary DSPDIV=2 =11 if tertiary DSPDIV=5

Table 7-6. Stream Format Tokens

Format Identifier	Defined By	Description
B17	Configuration	=000 if current DECPNT=8888800 =001 if current DECPNT=8888880 =010 if current DECPNT=8888888 =011 if current DECPNT=888888.8 =100 if current DECPNT=88888.88 =101 if current DECPNT=8888.888 =110 if current DECPNT=888.8888 =111 if current DECPNT=88.88888
B18	Configuration	=000 if primary DECPNT=8888800 =001 if primary DECPNT=8888880 =010 if primary DECPNT=8888888 =011 if primary DECPNT=888888.8 =100 if primary DECPNT=88888.88 =101 if primary DECPNT=8888.888 =110 if primary DECPNT=888.8888 =111 if primary DECPNT=88.88888
B19	Configuration	=000 if secondary DECPNT=8888800 =001 if secondary DECPNT=8888880 =010 if secondary DECPNT=8888888 =011 if secondary DECPNT=888888.8 =100 if secondary DECPNT=88888.88 =101 if secondary DECPNT=8888.888 =110 if secondary DECPNT=888.8888 =111 if secondary DECPNT=88.88888
B20	Configuration	=000 if tertiary DECPNT=8888800 =001 if tertiary DECPNT=8888880 =010 if tertiary DECPNT=8888888 =011 if tertiary DECPNT=888888.8 =100 if tertiary DECPNT=88888.88 =101 if tertiary DECPNT=8888.888 =110 if tertiary DECPNT=888.8888 =111 if tertiary DECPNT=88.88888
<wspec [-] [0] digit[.].digit>	Scale weight	Weight for the source scale. <b>wspec</b> is defined as follows: <b>wspec</b> indicates whether the weight is the current displayed weight (W, w), gross (G, g), net (N, n) or tare (T, t) weight; upper-case letters specify right-justified weights, lower-case are left-justified Optional /P, /S or /T suffixes can be added before the ending delimiter (>) to specify weight display in primary (/P), secondary (/S) or tertiary (/T) units [-] Enter a minus sign (-) to include sign for negative values [0] Enter a zero (0) to display leading zeros digit[.].digit  The first digit indicates the field width in characters; the decimal point only indicates a floating decimal; a decimal point with a following digit indicates fixed decimal with <b>n</b> digits to the right of the decimal; two consecutive decimals send the decimal point even if it falls at the end of the transmitted weight field
<CR>	--	Carriage return
<LF>	--	Line feed

Table 7-6. Stream Format Tokens (Continued)

## 8.0 Digital I/O

Digital inputs can be set to provide indicator functions, including all keypad functions. Digital inputs are active low (0 VDC) and inactive high (5 VDC).

Digital outputs are typically used to control relays drive other equipment. Outputs are designed to sink, rather than source, switching current. Each output is normally an open collector circuit, capable of sinking 20 mA when active. Digital outputs are used to change a relay state when the digital output is active (low, 0 VDC) with reference to a 5 VDC supply.

From the Configuration menu, select the **Digital I/O** icon  (circled in [Figure 8-1](#)) to enter the **Digital I/O** menu.

Once all parameters have been set, select  to return to weigh mode.

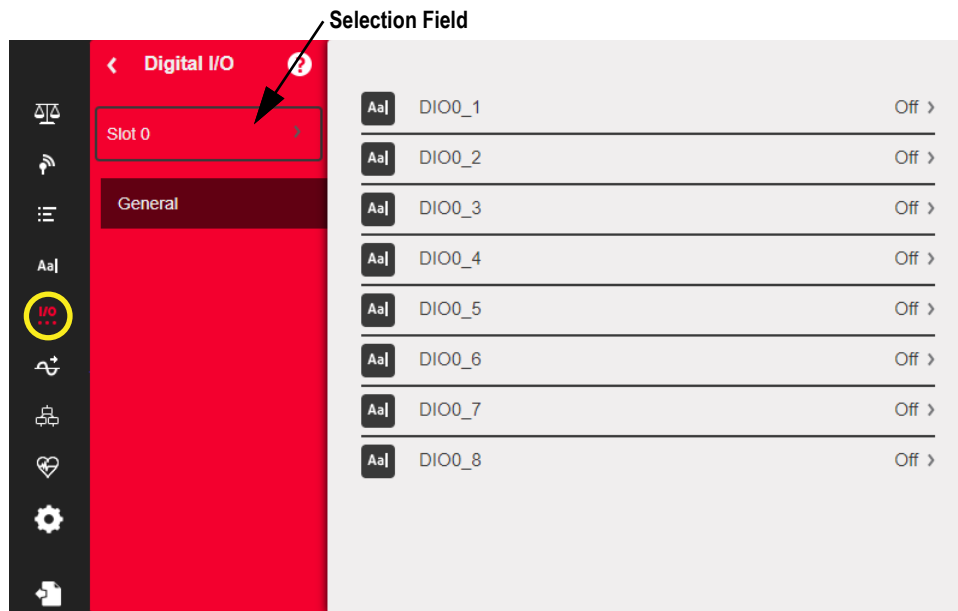



Figure 8-1. Digital I/O Menu

The Digital I/O menu is used to assign functions to digital inputs and outputs.

Slot 0 – eight I/O bits available on the CPU board (connector J1).

Slot 1-6 – up to 24 I/O bits are available per Digital I/O expansion card, if installed.

1. If using an optional Digital I/O card, press Slot 0 in order to select the slot containing the card.

 **NOTE: Slot 0 is always available.**

2. Select the desired Digital I/O from the list displayed. The following functions display.

Function	Description
Off	Indicates the bit is not configured
Output	Assigns the bit as a digital output for setpoint or iRite program use
Input	Assigns the bit as a digital input used for Digital Input setpoints
Programmability	Assigns the bit as a digital input used to generate a iRite program event
Zero	Provides the same function as the front panel Zero key
Gross/Net	Provides the same function as the front panel Gross/Net key
Tare	Provides the same function as the front panel Tare key
Units	Provides the same function as the front panel Units key
Print	Provides the same function as the front panel Print key
Accumulate	Adds the current scale weight to the accumulator, if enabled
Clear Accumulator	Clears the accumulated value for the current scale, if enabled
Setpoint	Provides the same function as the Setpoint softkey
Time/Date	Provides the same function as the Time/Date softkey
Display Tare	Displays the current scale tare, same function as the Display Tare softkey
Clear Key	Provides the same function as the front panel Clear key
Cancel Key	Provides the same function as the Cancel softkey
Numeric Keys 0-9	Provides the same functions as the front panel numeric keys
Decimal Point Key	Provides the same function as the front panel Decimal Point key
Enter Key	Provides the same function as the front panel Enter key
Navigate Up	Provides the same function as the front panel Up Arrow key
Navigate Down	Provides the same function as the front panel Down Arrow key
Navigate Left	Provides the same function as the front panel Left Arrow key
Navigate Right	Provides the same function as the front panel Right Arrow key
Keyboard Lock	Locks the front panel keyboard while the input is active
Hold	Holds the current scale weight display while this input is active
Batch Run	Batch Run must be held active for a batch to start or run; if made inactive while a batch is running, the batch stops and remain at the current step; if it is not defined, a batch starts anytime the Batch Start softkey is pressed, the Batch Start digital input is activated or a Batch Start serial command is received
Batch Start	Starts a batch from the current step if a Batch Run digital input is either active or not defined; if a Batch Run digital input is defined and inactive, Batch Start resets the batch to the first step
Batch Pause	Pauses a batch while the input is held active and turns off all digital outputs except those associated with Concurrent and Timer setpoints; Processing is suspended until the Batch Pause input is made inactive
Batch Reset	Stops an active batch and resets the current step to the first batch step; all digital outputs associated with batch setpoints are deactivated; if a batch is stopped or paused, Batch Reset resets the current step to the first step
Batch Stop	Stops an active batch and turns off all associated digital outputs; requires a Batch Start to resume processing
Clear Consecutive Number	Resets the consecutive numbering to the value specified in Consecutive Number Start
Gross	Set current scale to display gross weight
Net	Set current scale to display net weight
Primary Units	Set current scale to display in primary Units
Secondary Units	Set current scale to display in secondary Units
Tertiary Units	Set current scale to display in tertiary Units
Clear Tare	Clears the tare value of the current scale
Pulse Input	Allows ability to count pulses using a custom iRite application; the maximum pulse input frequency is 5 kHz <i>Example: to measure water being metered into a tank.</i>

Table 8-1. Digital I/O Types

## 9.0 Analog Output

The Analog Output menu is only functional if the analog output option card is installed. If it is not installed, the menu is visible, but not functional. If the analog output option is installed, configure all other indicator functions and calibrate the indicator before configuring the analog output.

From the Configuration menu, select  (circled in [Figure 9-1](#)) to enter the Analog Output menu.

Once all settings are correct, select  to return to weigh mode.

Whether using Single Analog Output cards or Dual Analog Output cards, the actual analog outputs are identified by a number. Two output ID numbers can be applied per slot.

*Example: the output in slot 1 channel 2 is number 2.*

Select the analog output number which needs to be configured.

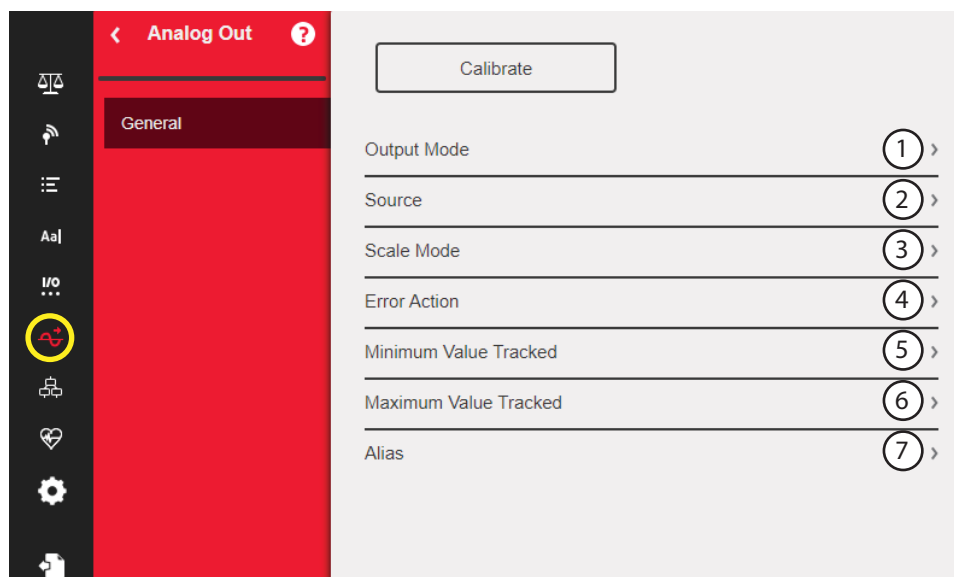

Figure 9-1. Analog Output Menu Screen

Item No.	Parameter	Description
1	Output Mode	Specifies the voltage or current which is tracked by the analog output; select: <b>0–10 V</b> (default), 4–20 mA, 0–20 mA
2	Source	Scale 1-8 specifies the scale tracked by the analog output; programmability indicates the analog output is under iRite program control; select scale: <b>1</b> (default)
3	Scale Mode	Specifies the weight data, gross or net, tracked by the analog output when source is assigned to a scale; select: <b>Gross</b> (default), Net
4	Error Action	Specifies how the analog output responds to system error conditions <ul style="list-style-type: none"> <li>• <b>Full Scale</b> (default) – set to full scale (10 V or 20 mA)</li> <li>• Hold – holds current value</li> <li>• Zero Scale – set to zero value (0 V, 0 mA or 4 mA)</li> </ul>
5	Minimum Value Tracked	Specifies the minimum weight value tracked by the analog output; enter value: -9999999–9999999, <b>0</b> (default)
6	Maximum Value Tracked	Specifies the maximum weight value tracked by the analog output; enter value: -9999999–9999999, <b>10,000</b> (default)
7	Alias	Enter an alias name for the analog output

Table 9-1. Analog Output Parameters

## Analog Output Calibration

The following calibration procedure requires a multimeter to measure voltage or current output from the analog output module.



**NOTE:** *The analog output must be calibrated after the indicator itself has been configured and calibrated.*

1. Select the analog output number.
2. Connect the multimeter to connector J1 to calibrate channel 1 on the analog output card. Connect to J2 for channel 2 for the dual analog output card.
  - For voltage output, connect the voltmeter leads to pins 3 (+) and 4 (-)
  - For current output, connect the ammeter leads to pins 1 (+) and 2 (-)
3. Select **Calibrate**.
4. Select the desired output mode.
5. Select **Next**.
6. Select **123...** and enter the observed milliamp or voltage reading. The minimum calibration occurs at 0.5 V for a 0–10 V output and at 1 mA for a 0–20 mA output.
7. Press .
8. Press **Calibrate Minimum**.
9. Press **Next**.
10. Press **Set to Maximum**.
11. Select **123...** and enter the observed milliamp or voltage reading.
12. Press .
13. Press **Calibrate Maximum**.
14. Press **Next**.
15. Press **Set to Minimum** and **Set to Maximum** to check calibration results.
16. Repeat [Step 6](#) through [Step 15](#) until calibration results are satisfactory.
17. Press **Finish**. The display returns to the **Analog Output** menu.
18. Press **Save and Exit** to save the calibration parameters.

## 10.0 Setpoints

The 1280 indicator provides 100 configurable setpoints for control of the indicator and external equipment functions. Setpoints can be configured to perform actions or functions based on specified parameter conditions.

Parameters associated with various setpoint kinds can be configured to:

- Perform functions such as print, tare, or accumulate
- Change the state of a digital output
- Make conditional decisions

From the Configuration menu, select  (circled in [Figure 10-1](#)) to enter the **Setpoints** menu.

Once all settings are correct, select  to return to weigh mode.

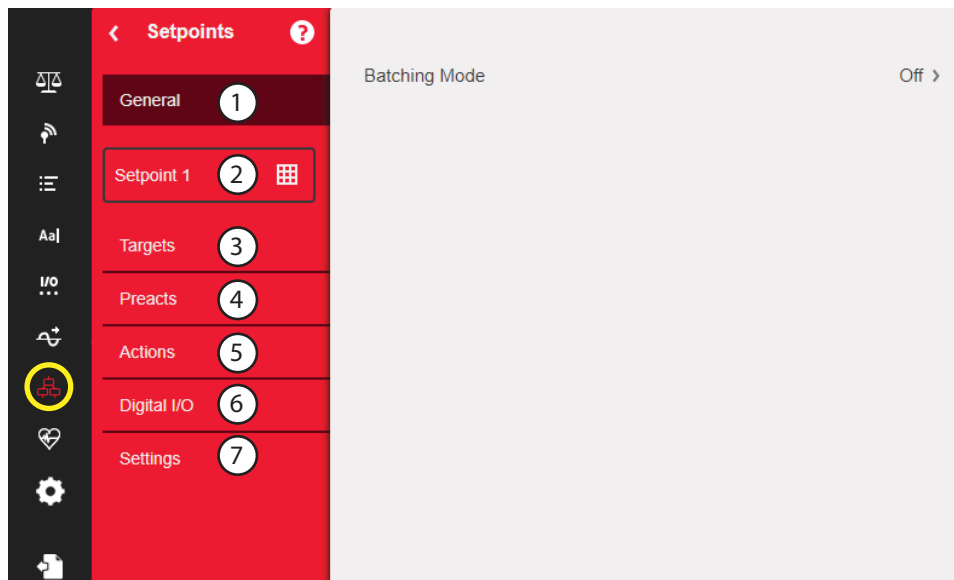

Figure 10-1. Setpoints Menu

Item No.	Description
1	General – select <b>Automatic Restart</b> or <b>Manual Restart</b> to allow a batch sequence to run: <ul style="list-style-type: none"> <li>• <b>Manual</b> requires a Batch Start signal (a Batch Start digital input, BATSTART serial command, Batch Start softkey, or the StartBatch function in an iRite program) before the batch sequence can run</li> <li>• <b>Automatic</b> allows the batch sequence to restart automatically once it has been started</li> </ul>
2	Setpoint # – select Setpoint Kind, see <a href="#">Section 10.1 on page 104</a> to configure parameters available for setpoint kind selected
3	Targets – sets the value at which the setpoint trips, see <a href="#">Table 10-3 on page 111</a>
4	Preacts – select parameters which allow a setpoint to become satisfied before its target value is reached; this allows for material in suspension, see <a href="#">Table 10-4 on page 112</a>
5	Actions – selects functions which are performed when the setpoint is satisfied, see <a href="#">Table 10-5 on page 112</a>
6	Digital I/O – selects a digital output which is controlled by the setpoint, see <a href="#">Table 10-6 on page 112</a>
7	Settings – selects the mode of the setpoint (batch or free-running); if enabled, it can be accessed by softkey, for defining a name and optional prompt, see <a href="#">Table 10-7 on page 112</a>

Table 10-1. Setpoint Menu Parameters

## 10.1 Select Setpoint for Configuration

1. Press **Setpoint 1** to select the setpoint (1–100) for which the target value needs to be changed.
2. Press the red number of the setpoint in the table (use the arrows to scroll through the setpoints).

SETPOINT	KIND	VALUE	I/O	TRIP	BATCH
1	Off	0	None		OFF
2	Off	0	None		OFF
3	Off	0	None		OFF
4	Off	0	None		OFF
5	Off	0	None		OFF

Figure 10-2. Setpoint Select Display

3. Press **Done**. displays.
4. Press to select the **Setpoint Kind**, see [Table 10-2](#).
5. Press to rename the setpoint. A keyboard displays.
6. Enter the desired name and press **Done**.
7. Press **Value** to bring up the numeric entry keyboard, if needed.
8. Enter the new target value and press **Done**.
9. Configure the setpoint using the menus in [Section 10.2 on page 106](#).

**NOTE:** Setpoint values can be configured in Weigh Mode, see [Section 1.12 on page 20](#).

Parameter	Description	Batch	Continuous
Off	Setpoint turned off/ignored	--	--
Gross	Performs functions based on the gross weight; the target weight entered is considered a positive gross weight	X	X
Net	Performs functions based on the net weight; the target weight entered is considered a positive net weight value	X	X
Negative Gross	Negative gross weight; performs functions based on the gross weight; the target weight entered is considered a negative gross weight	X	X
Negative Net	Negative net weight; performs functions based on the net weight; the target weight entered is considered a negative net weight value	X	X
Accumulate	Compares the value of the setpoint to the source scale accumulator; the accumulator setpoint is satisfied when the value of the source scale accumulator meets the value and conditions of the accumulator setpoint	X	X
Positive Relative	Performs functions based on a specified value above a referenced setpoint, using the same weight mode as the referenced setpoint	X	X
Negative Relative	Performs functions based on a specified value below a referenced setpoint, using the same weight mode as the referenced setpoint	X	X
Percent Relative	Performs functions based on a specified percentage of the target value of a referenced setpoint, using the same weight mode as the referenced setpoint; the actual target value of the percent relative setpoint is calculated as a percentage of the target value of the referenced setpoint	X	X

Table 10-2. Setpoint Kinds



Parameter	Description	Batch	Continuous
Pause	Pauses the batch sequence indefinitely; a Batch Start signal must be initiated to continue the batch process	X	--
Delay	Delays the batch sequence for a specified time; the length of the delay (in tenths of a second) is specified on the Value parameter	X	--
Wait Standstill	Suspends the batch sequence until the scale is at standstill	X	--
Counter	Specifies the number of consecutive batch sequences to perform; counter setpoints should be placed at the beginning of a batch routine	X	--
Auto-Jog	Automatically checks the previous weight-based setpoint to verify which the setpoint weight value is satisfied in a standstill condition: <ul style="list-style-type: none"> <li>If the previous setpoint is not satisfied when at standstill, the <b>AUTOJOG</b> setpoint activates the digital output of the previous weight-based setpoint for a period of time, specified on the Value parameter (in tenths of a second)</li> <li>The AUTOJOG process repeats until the previous weight-based setpoint is satisfied when the scale is at standstill</li> </ul> <p><b>NOTE: The AUTOJOG digital output is typically used to signify an AUTOJOG operation is being performed.</b>  <b>AUTOJOG uses the digital output of the previous weight-based setpoint, and should not be assigned to the same digital output as the related weight-based setpoint.</b></p>	X	--
Center of Zero	Monitors for a gross center of zero condition: <ul style="list-style-type: none"> <li>The digital output associated with this setpoint kind is activated when the referenced scale is at center of zero</li> <li>No value is required for this setpoint</li> </ul>	--	X
In-Motion	Monitors for an in-motion condition: <ul style="list-style-type: none"> <li>The digital output associated with this setpoint is activated when the scale is not at standstill</li> <li>No value is required for this setpoint</li> </ul>	--	X
In-Range	Monitors for an in-range condition: <ul style="list-style-type: none"> <li>The digital output associated with this setpoint is activated when the scale is within capacity range</li> <li>No value is required for this setpoint</li> </ul>	--	X
Batch in Process	Batch processing signal: <ul style="list-style-type: none"> <li>The digital output associated with this setpoint is activated whenever a batch sequence is in progress</li> <li>No value is required for this setpoint</li> </ul>	--	X
Timer	Tracks the progress of a batch sequence based on a timer: <ul style="list-style-type: none"> <li>The timer value, in tenths of a second, determines the length of time allowed between start and end setpoints</li> <li>Start and End parameters are used to specify the start and end setpoints</li> <li>If the End setpoint is not reached before the timer expires, the digital output associated with this setpoint is activated</li> </ul>	--	X
Concurrent	Allows a digital output to remain active over a specified portion of the batch sequence: <ul style="list-style-type: none"> <li><b>Type 1 (VALUE=0):</b> the digital output associated with this setpoint becomes active when the Start setpoint becomes the current batch step and remains active until the End setpoint becomes the current batch step</li> <li><b>Type 2 (VALUE &gt; 0):</b> if a non-zero value is specified for the Value parameter (value represents the timer) in tenths of a second, for this setpoint; the digital output associated with this setpoint becomes active when the Start setpoint becomes the current batch step and remains active until the timer expires</li> </ul>	--	X
Digital Input	Requires a specific group of digital inputs to be in a low (0 VDC) state to satisfy the setpoint; the digital output associated with this setpoint is held in a low (0 VDC) state until the inputs selected for the digital input mask are all in a low state	X	X
Time of Day	Performs functions when the internal clock time of the indicator matches the specified setpoint time	X	X
Always	This setpoint is always satisfied; it is typically used to provide an endpoint for true/false branching batch routines	X	--
Never	This setpoint is never satisfied: <ul style="list-style-type: none"> <li>It is used to branch to a designated setpoint in true/false branching batch routines in which the batch does not continue through the normal sequence of batch setpoints</li> </ul>	X	--
Digital Input Count	Counts pulses received at the specified digital input	X	X

Table 10-2. Setpoint Kinds (Continued)

## 10.2 Setpoint Configuration

Setpoint kinds have different parameters which can be configured. The following charts illustrate the parameters available based on the setpoint kind selected.

### Gross/Net/Negative Gross/Negative Net

Target						
Value	Source	Trip		Inband/Outband		
Enter Value	Scale 1-8	Higher/Lower	Band Value			
		Hysteresis				
Preact						
Preact		Learn		Flow		
Off	On	Preact Value	Preact Value	Preact Value		
		Preact Adjust	Preact Adjust	Preact Adjust		
		Preact Stability	Preact Stability	Preact Stability		
		Preact Count	Preact Count	Preact Count		
Actions						
Alarm	Clear Accum.	Clear Tare	Push Accum.	Push Print	Push Tare	
OFF	OFF	OFF	Off	Off	OFF	
ON	ON	ON	On	On	ON	
			Quiet	Wait Standstill		
Digital I/O						
Sense		Slot				
Normal	Invert	None				
		Slot 1-6				
Settings						
Batch	Access	Enable	Alias	Prompt		
OFF	On	OFF	Enter	Enter		
ON	Off	ON	Value	Value		
	Branch	Hide				

Figure 10-3. Gross/Net/Negative Gross/Negative Net Setpoint Parameters

### Accumulate

<b>Target</b>						
Value	Source	Trip		Relative Setpoint Number		
Enter Value	Scale 1-8	Higher/Lower	Inband/Outband	Enter Value		
		<a href="#">Hysteresis</a>	<a href="#">Band Value</a>			
<b>Preact</b>						
No parameters to be set.						
<b>Actions</b>						
Alarm	Clear Accum.	Clear Tare	Push Accum.	Push Print	Push Tare	
OFF	OFF	OFF	Off	Off	OFF	
ON	ON	ON	On	On	ON	
			Quiet	Wait Standstill		
<b>Digital I/O</b>						
Sense	Slot					
Normal	None					
Invert	Slot 1-6					
<b>Settings</b>						
Batch	Access	Enable	Alias	Prompt		
OFF	On	OFF	Enter Value	Enter Value		
ON...	Off	ON				
	<a href="#">Branch</a>	Hide				

Figure 10-4. Accumulate Setpoint Parameters

### Positive Relative/Negative Relative/Percent Relative

<b>Target</b>						
Value	Source	Trip		Relative Setpoint Number		
Enter Value	Scale 1-8	Higher or Lower	Inband or Outband	Enter Value		
		<a href="#">Hysteresis</a>	<a href="#">Band Value</a>			
<b>Preact</b>						
Off	On	Learn		Flow		
	<a href="#">Preact Value</a>	<a href="#">Preact Value</a>	<a href="#">Preact Value</a>			
		<a href="#">Preact Adjust</a>	<a href="#">Preact Adjust</a>			
		<a href="#">Preact Stability</a>	<a href="#">Preact Stability</a>			
		<a href="#">Preact Count</a>	<a href="#">Preact Count</a>			
<b>Actions</b>						
Alarm	Clear Accum.	Clear Tare	Push Accum.	Push Print	Push Tare	
OFF	OFF	OFF	Off	Off	OFF	
ON	ON	ON	On	On	ON	
			Quiet	Wait Standstill		
<b>Digital I/O</b>						
Sense	Slot					
Normal	None					
Invert	Slot 1-6					
<b>Settings</b>						
Batch	Access	Enable	Alias	Prompt		
OFF	On	OFF	Enter Value	Enter Value		
ON...	Off	ON				
	<a href="#">Branch</a>	Hide				

Figure 10-5. Positive Relative/Negative Relative/Percent Relative Setpoint Parameters

**Pause**

<b>Target</b>		
No parameters to be set.		
<b>Preact</b>		
No parameters to be set.		
<b>Actions</b>		
No parameters to be set.		
<b>Digital I/O</b>		
Sense	Slot	
Normal	None	
Invert	Slot 1-6	
<b>Settings</b>		
Access	Alias	Prompt
On	Enter	Enter
Off	Value	Value
Hide		

**Delay**

<b>Target</b>				
Value	Source			
Enter	Scale 1-8			
Value				
<b>Preact</b>				
No parameters to be set.				
<b>Actions</b>				
Clear Accum.	Clear Tare	Push Accum.	Push Print	Push Tare
OFF	OFF	Off	Off	OFF
ON	ON	On	On	ON
		Quiet	Wait Standstill	
<b>Digital I/O</b>				
Sense	Slot			
Normal	None			
Invert	Slot 1-6			
<b>Settings</b>				
Access	Alias	Prompt		
On	Enter	Enter		
Off	Value	Value		
Hide				

Figure 10-6. Pause and Delay Setpoint Parameters

**Wait Standstill**

<b>Target</b>						
Source						
Scale 1-8						
<b>Preact</b>						
No parameters to be set.						
<b>Actions</b>						
Alarm	Clear Accum.	Clear Tare	Push Accum.	Push Print	Push Tare	
OFF	OFF	OFF	Off	Off	OFF	
ON	ON	ON	On	On	ON	
			Quiet	Wait Standstill		
<b>Digital I/O</b>						
Sense	Slot					
Normal	None					
Invert	Slot 1-6					
<b>Settings</b>						
Access	Alias	Prompt				
On	Enter	Enter				
Off	Value	Value				
Hide						

**Counter**

<b>Target</b>			
Value			
Enter Value			
<b>Preact</b>			
No parameters to be set.			
<b>Actions</b>			
No parameters to be set.			
<b>Digital I/O</b>			
Sense	Slot		
Normal	None		
Invert	Slot 1-6		
<b>Settings</b>			
Branch	Access	Alias	Prompt
Enter	On	Enter	Enter
Value	Off	Value	Value
	Hide		

Figure 10-7. Wait Standstill and Counter Setpoint Parameters

### Auto-Jog

<b>Target</b>		
Source		
Scale 1-8		
<b>Preact</b>		
No parameters to be set.		
<b>Actions</b>		
Clear Accum.	Clear Tare	Push Accum.
OFF	OFF	Off
ON	ON	On
		Quiet
Push Print		Push Tare
Off		OFF
On		ON
		Wait Standstill
<b>Digital I/O</b>		
Sense	Slot	
Normal	None	
Invert	Slot 1-6	
<b>Settings</b>		
Access	Alias	Prompt
On	Enter	Enter
Off	Value	Value
Hide		

### Center Of Zero/In-Motion/In-Range

<b>Target</b>	
Source	
Scale 1-8	
<b>Preact</b>	
No parameters to be set.	
<b>Actions</b>	
No parameters to be set.	
<b>Digital I/O</b>	
Sense	Slot
Normal	None
Invert	Slot 1-6
<b>Settings</b>	
Access	
On	
Off	
Hide	

Figure 10-8. Auto-Jog and Center of Zero/In-Motion/In-Range Setpoint Parameters

### Batch in Process

<b>Target</b>	
No parameters to be set.	
<b>Preact</b>	
No parameters to be set.	
<b>Actions</b>	
No parameters to be set.	
<b>Digital I/O</b>	
Sense	Slot
Normal	None
Invert	Slot 1-6
<b>Settings</b>	
Access	
On	
Off	
Hide	

### Timer, Concurrent

<b>Target</b>		
Value	Start Setpoint Number	End Setpoint Number
Enter Value	Enter Value	Enter Value
<b>Preact</b>		
No parameters to be set.		
<b>Actions</b>		
No parameters to be set.		
<b>Digital I/O</b>		
Sense	Slot	
Normal	None	
Invert	Slot 1-6	
<b>Settings</b>		
Access		
On		
Off		
Hide		

Figure 10-9. Batch in Process and Timer/Concurrent Setpoint Parameters

### Digital Input

<b>Target</b>					
Digital Input Slot		Mask			
Enter Value				Enter Value	
<b>Preact</b>					
No parameters to be set.					
<b>Actions</b>					
Alarm	Clear Accum.	Clear Tare	Push Accum.	Push Print	Push Tare
OFF	OFF	OFF	Off	Off	OFF
ON	ON	ON	On	On	ON
			Quiet	Wait Standstill	
<b>Digital I/O</b>					
Sense		Slot			
Normal		None			
Invert		Slot 1-6			
<b>Settings</b>					
Batch		Access	Alias	Prompt	
OFF		On	Enter	Enter	
ON		Off	Value	Value	
	<a href="#">Branch</a>	Hide			

Figure 10-10. Digital Input Setpoint Parameters

### Time of Day

<b>Target</b>		
Time (HHMM)	Duration (HHMMSS)	Source
Enter Value	Enter Value	Scale 1-8
<b>Preact</b>		
No parameters to be set.		
<b>Actions</b>		
Clear Accum.	Clear Tare	Push Accum.
OFF	OFF	Off
ON	ON	On
		Quiet
		Wait Standstill
<b>Digital I/O</b>		
Sense		Slot
Normal		None
Invert		Slot 1-6
<b>Settings</b>		
Batch	Access	Alias
OFF	On	Enter
ON	Off	Value
	Hide	Value

### Always, Never

<b>Target</b>
No parameters to be set.
<b>Preact</b>
No parameters to be set.
<b>Actions</b>
No parameters to be set.
<b>Digital I/O</b>
No parameters to be set.
<b>Settings</b>
<a href="#">Branch (Never only)</a>
Enter Value
No parameters to be set (Always only).

Figure 10-11. Time of Day and Always/Never Setpoint Parameters

## Digital Input Count

Target			
Digital Input Slot	Mask	Value	Pre-Count
Enter Slot	Enter Value	Enter Value	Enter Value
Preact			
No parameters to be set.			
Actions			
No parameters to be set.			
Digital I/O			
Sense	Slot		
Normal	None		
Invert	Slot 1-6		
Settings			
Batch	Access	Alias	Prompt
OFF	On	Enter Value	Enter Value
ON	Off		
	Hide		

Figure 10-12. Digital Input Count Setpoint Parameters

## 10.2.1 Targets

Parameter	Description
Value	Setpoint Value; Enter Value: <b>0</b> (default): <ul style="list-style-type: none"> <li>Weight-based – specifies the target weight value, 0–9999999</li> <li>Time-based – specifies time in 0.1 second intervals, range 0–65535</li> <li>Counter – specifies the number of consecutive batches to run, range 0–65535</li> </ul>
Source	Select Scale 1–8; <b>Scale 1</b> (default)
Trip	Specifies if the setpoint is satisfied when the weight is higher or lower than the setpoint value, within a band established around the value or outside of the band. In a batch sequence with: <ul style="list-style-type: none"> <li><b>Trip = Higher</b> (default) – the associated digital output is active until the setpoint value is exceeded</li> <li><b>Trip = Lower</b> – the output is active until the weight goes below the setpoint value</li> <li><b>Trip = Inband</b> – the setpoint is satisfied when the weight is within a band established around the value</li> <li><b>Trip = Outband</b> – the setpoint is satisfied when the weight is outside a band established around the value, excluding the value</li> </ul>
Hysteresis	When <b>Trip</b> is set to <b>Higher/Lower</b> , specifies a band around the setpoint value which must be exceeded before a setpoint which is off can trip on again; enter value: <b>0</b> (default)
Band Value	When <b>Trip</b> is set to <b>Inband/Outband</b> , this specifies a weight equal to half the band width; the band established around the setpoint value is <b>Value ± Band Value</b> ; enter value: <b>0</b> (default)
Relative Setpoint Number	For relative setpoints, specifies the number of the relative setpoint; enter value: <b>0</b> (default); the target weight for this setpoint is determined as follows: <ul style="list-style-type: none"> <li>Positive Relative setpoints – value of the relative setpoint plus the value of the Positive Relative setpoint</li> <li>Negative Relative setpoints – value of the relative setpoint minus the value of the Negative Relative setpoint</li> <li>Percent Relative setpoints – percentage (specified on the Value parameter of the Percent Relative setpoint) of the target value of the relative setpoint</li> </ul>
Digital Input Slot	Lists all available digital I/O slots; specifies the slot number of the digital I/O card referenced by the Digital Input Slot parameter; enter slot number: <b>Slot 0</b> (default)
Mask	The digital input bits which are associated with a digital input or digital input count setpoint; all defined digital inputs have to go active for the setpoint to be satisfied; enter value: <b>0</b> (default)
Pre-Count	Value at which the digital input counter setpoint starts to increment; enter value: <b>0</b> (default)
Start Setpoint Number	Specifies the starting setpoint number (when timer or concurrent setpoints turn on); do not specify the start number of the timer or concurrent setpoint, begins when the starting setpoint begins; enter value: <b>1</b> (default)
End Setpoint Number	Specifies the ending setpoint number (when the timer or concurrent setpoints turn off); do not specify the end number of the timer or concurrent setpoint, stops when the ending setpoint begins; enter value: <b>1</b> (default)
Time	Specifies the time of day the setpoint becomes active; sets hours and minutes – HHMM; enter value: <b>0000</b> (default)
Duration	Specifies the length of time which the digital output associated with this setpoint changes state; all other operations associated with this setpoint (print, tare or accumulate) are performed at the end of the specified duration; set duration format – HHMMSS; enter value: <b>000000</b> (default)

Table 10-3. Target Parameters

## 10.2.2 Preacts

Parameter	Description
Preact	Preact helps compensate for material in a free-fall state to ensure targets are met; set: <b>Off</b> (default), Learn, Flow or On
Preact Value	Specifies the preact value for setpoints with Preact Type set to On, Learn, or Flow; depending on the Trip setting specified for the setpoint, it is adjusted up or down by the Preact Adjust value; enter value: range is $\pm 0$ –999999, <b>0</b> (default)
Preact Adjust (%)	For setpoints with Preact Type set to Learn, Preact Adjust specifies the percentage of error correction applied to preact; enter value: range is 0.0–100.0%, <b>0.0%</b> (default)
Preact Stability (seconds)	For setpoints with Preact Type set to Learn, Preact Stability specifies the time (0.1 second), to wait for standstill before adjusting the Preact Value; setting this parameter to a value greater than zero disables the learn process if standstill is not achieved in the specified interval; enter value: range is 0–65535, <b>0.0</b> (default)
Preact Count	For setpoints with Preact Type set to Learn, Preact Count specifies the number of batches before the Preact Value is recalculated; enter value: range is 1–65535, <b>1</b> (default); the default value (1) recalculates the Preact Value after every batch cycle

Table 10-4. Preact Parameters

## 10.2.3 Actions

Parameter	Default	Description
Alarm	Off	<b>Alarm</b> displays on the primary display while the setpoint is active (batch setpoints) or while the setpoint is not tripped (continuous setpoints); set: <b>Off</b> (default) or On
Clear Accumulator	Off	Clears the accumulator when the setpoint is satisfied; set: <b>Off</b> (default) or On
Clear Tare	Off	Clears the tare when the setpoint is satisfied; set: <b>Off</b> (default) or On
Push Accumulate	Off	<b>On</b> updates the accumulator and performs a print operation when the setpoint is satisfied. <b>Quiet</b> updates the accumulator without printing; set: <b>Off</b> (default), On or Quiet <b>NOTE: Push Accumulate uses accumulator print format; See Section 7.1.1 on page 93</b>
Push Print	Off	<b>On</b> performs a print operation when the setpoint is satisfied; <b>Wait Standstill</b> waits until no motion is detected, after the setpoint is satisfied, before printing; set: <b>Off</b> (default), On or Wait Standstill <b>NOTE: Push Print uses setpoint print format; See Section 7.1.1 on page 93</b>
Push Tare	Off	Performs an acquire tare operation when the setpoint is satisfied; set: <b>Off</b> (default) or On <b>NOTE: Push Tare acquires the tare regardless of the value specified for the Regulatory parameter on the Feature menu, see Section 6.3 on page 85</b>

Table 10-5. Actions Parameters

## 10.2.4 Digital I/O

Parameter	Description
Sense	Specifies whether the digital output is active low, <b>Normal</b> (default), or active high, Invert
Slot	Slot number from which digital inputs are read; Select Slot 1–8, <b>None</b> (default)
Digital Output	The Digital I/O bit associated with the setpoint, after a slot is selected; <b>0</b> (default)

Table 10-6. Digital I/O Parameters

## 10.2.5 Settings

Parameter	Description
Batch	Specifies whether the setpoint is used as a batch or continuous setpoint; select: <b>Off</b> (default continuous), On (batch)
Branch	If Batch is set to on, specifies the setpoint number to which the batch sequence is to branch if the current setpoint is not satisfied upon initial evaluation; the special value zero indicates no branch is taken; enter setpoint number or <b>0</b> (default)
Access	Specifies the access allowed to setpoint parameters by pressing the <b>Setpoint</b> softkey in weigh mode; Select: <b>On</b> (default), Off (values can be displayed but not changed), Hide (hide values)
Enable	Turns the setpoint <b>On</b> (default) or Off
Alias	Enter a name for the setpoint
Prompt	Alphanumeric message or prompt which can be displayed in a label widget

Table 10-7. Settings Parameters



## 10.3 Batch Operations

Softkeys can be configured to allow operator control of batch operations from the 1280 front panel, or they can be configured using <Prodfont>Revolution III, serial commands or the **Features** menu, see [Section 6.1 on page 82](#).

<b>Setpoint</b>	Display or change assigned setpoints.
<b>Batch Start</b>	Starts a batch from the current step if a Batch Run digital input is either active or not defined. If a Batch Run digital input is defined and inactive, Batch Start resets the batch to the first step.
<b>Batch Pause</b>	Pauses an active batch and turns off all digital outputs except those associated with concurrent and timer setpoints. Processing is suspended until the indicator receives a batch start signal. Pressing the <b>Batch Start</b> digital input, <b>BATSTART</b> serial command, <b>Batch Start</b> softkey or the <b>StartBatch</b> function (in iRite) resumes the batch and re-energizes all digital outputs turned off by the <b>Batch Pause</b> .
<b>Batch Reset</b>	Stops an active batch and resets the current step to the first batch step. All digital outputs associated with batch setpoints are deactivated. If a batch is stopped or paused, Batch Reset resets the current step to the first step.
<b>Batch Stop</b>	Stops an active batch and turns off all associated digital outputs. Requires a Batch Start to resume processing.



**WARNING:** To prevent personal injury and equipment damage, software-based interruptions must always be supplemented by emergency stop switches and other safety devices necessary for the application.

### Batching Switch

The batching switch option, PN 19369, comes as a complete unit in an FRP enclosure, with legend plate, emergency stop switch and a run/start/abort 3-way switch.

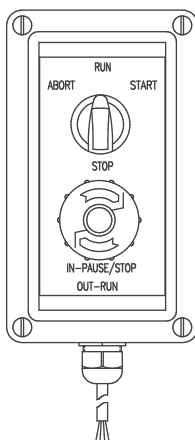

Figure 10-13. Batching Switch

Both switches are wired into the indicator's digital I/O terminal as in [Figure 10-14 on page 114](#).

Once cables and switches have been connected to the indicator, use the setup switch to place the indicator in setup mode. Use the **DIG I/O** menu to configure digital input and output functions, see [Section 8.0 on page 99](#).

When configuration is complete, exit setup mode. Initialize the batch by turning the 3-way switch to **Abort** then unlock the **Stop** button (the **Stop** button must be in the **Out** position to allow the batch process to run). The batching switch is now ready to use.



**WARNING:** If no digital input is assigned to Batch Run, batching proceeds as if Batch Run were always on: the batch starts when the 3-way switch is turned to Run, but the Stop button does not function.

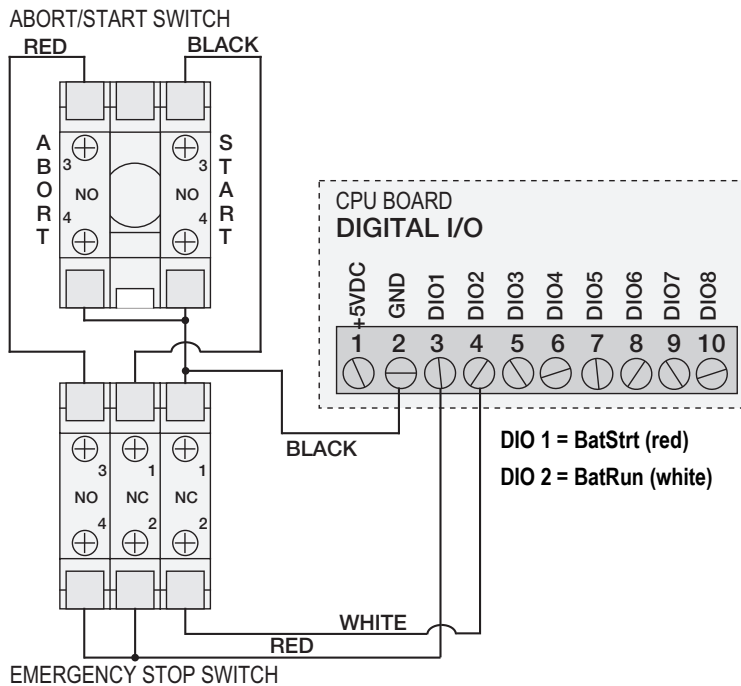

Figure 10-14. Batching Switch Wiring Diagram Example

E-Stop	Start/Abort	Description
Closed	Closed	Starts Batch (also used as restart)
Closed	Open	--
Open	Closed	Aborts Batch
Open	Open	Pauses Batch

Table 10-8. Batching Switch Process

To begin a batch process, turn the 3-way switch to **Start** momentarily. If the **Stop** button is pushed during the batch process, the process halts and the button locks in the **In** position.

The **Start** switch is ignored while the **Stop** button is locked in the **In** position. The **Stop** button must be turned counterclockwise to unlock it then released into the **Out** position to enable the 3-way switch.

To restart an interrupted batch from the step where it left off:

1. Unlock the **Stop** button (**Out** position).
2. Turn the 3-way switch to **Start**.

To restart an interrupted batch from the first batch step:

1. Push the **Stop** button.
2. Turn the 3-way switch to **Abort**.
3. Unlock the **Stop** button (**Out** position).
4. Turn the 3-way switch to **Start**.

To abort an interrupted batch:

1. Push the **Stop** button.
2. Turn 3-way switch to **Abort**.
3. Unlock STOP button (OUT position). A new batch can now be started.



**NOTE:** Use this procedure (or the **BATRESET** serial command) to initialize the new batch routine following any change to the setpoint configuration.

## 10.4 Batching Examples

### 10.4.1 Example 1

The following example uses six setpoints to dispense material from a hopper in 100-lb batches and to automatically refill the hopper when its weight drops below 300 lb.

Bits 1 and 2 in the Digital I/O menu are assigned to batch start and batch run functions: Batch Run must be on (low) before the Batch Start input starts the batch.

Slot 0, Bit 1 = Batch Start

Slot 0, Bit 2 = Batch Run

Batching = Manual

Setpoint 1 ensures the hopper has enough material to start the batch. If the hopper weight is 300 lb or higher, setpoint 1 is tripped.

Setpoint 1	Trip = Higher
Kind = Gross	Alarm = On
Value = 300	Batch = On

Setpoint 2 waits for standstill, then performs a tare to put the indicator into net mode.

Setpoint 2
Kind = Wait Standstill
Push Tare = On

Setpoint 3 is used as a reference (relative setpoint) for setpoint 4.

Setpoint 3	Trip = Higher
Kind = Net	Batch = Off
Value = 0	

Setpoint 4 is used to dispense material from the hopper. When the hopper weight falls to 100 lb less than its weight at the relative setpoint (setpoint 3), digital output 1 is set off.

Setpoint 4	Digital Output = 1
Kind = Negative Relative	Batch = On
Value = 100	Relative Setpoint Number = 3
Trip = Lower	

Setpoint 5 is used to evaluate the gross amount of material in the hopper after dispensing, and to maintain a minimum material level in the hopper. When the hopper weight falls below 300 lb, digital output 2 becomes active and the hopper is refilled to 1,000 lb.

Setpoint 5	Hysteresis = 700
Kind = Gross	Digital Output = 2
Value = 300	Batch = On
Trip = Higher	

Setpoint 6 is used to ensure the operation performed in setpoint 4 is completed within 10 seconds. The Start and End parameters identify the setpoints monitored by the Timer. If the Timer expires before Setpoint 5 starts, Digital Output 4 is turned on as an alarm to signal a process fault.

Setpoint 6	Start = 4
Kind = Timer	End = 5
Value = 100	Digital Output = 4

## 10.4.2 Example 2

The following example uses six setpoints to control a two-speed fill operation where both fast and slow feeds are on simultaneously.

Bits 1 and 2 in the Digital I/O menu are assigned to Batch Start and Batch Run functions. Batch Run must be on (low) before the Batch Start input starts the batch.

Slot 0, Bit 1 = Batch Start

Slot 0, Bit 2 = Batch Run

Batching = Manual

Setpoint 1 ensures the scale is empty ( $0 \pm 2$  lb).

Setpoint 1                      Trip = Inband

Kind = Gross                      Band Value = 2

Value = 0                      Batch = On

Setpoint 2 checks for the weight of a container (>5 lb) placed on the scale.

Setpoint 2                      Trip = Higher

Kind = Gross                      Batch = On

Value = 5

Setpoint 3 waits for standstill, then tares the container weight, placing the indicator in net mode.

Setpoint 3

Kind = Wait Standstill

Push Tare = On

Setpoint 4 starts the fast fill operation. When the net weight reaches 175 lb, the setpoint trips and digital output 1 is set off.

Setpoint 4                      Trip = Higher

Kind = Net                      Digital Output = 1

Value = 175                      Batch = On

Setpoint 5 controls the slow fill operation. When the net weight reaches 200 lb, the slow fill is stopped, the indicator waits for standstill and performs a push print operation using the Setpoint Format ticket format.

Setpoint 5                      Push Print = Wait Standstill

Kind = Net                      Digital Output = 2

Value = 200                      Batch = On

Trip = Higher

Setpoint 6 is a continuous setpoint, used to allow the slow feed output to be on at the same time as the fast fill. The slow fill output (Digital Output 2) is turned on when Setpoint 4 (fast fill) starts and remains on until Setpoint 5 begins.

Setpoint 6                      Start = 4

Kind = Concurrent                      End = 5

Value = 0                      Digital Output = 2

## 11.0 Diagnostics

From the Configuration menu, select the **Diagnostics** icon  (as shown in [Figure 11-1](#)) to enter the Diagnostics menu.

Select  to return to weigh mode.

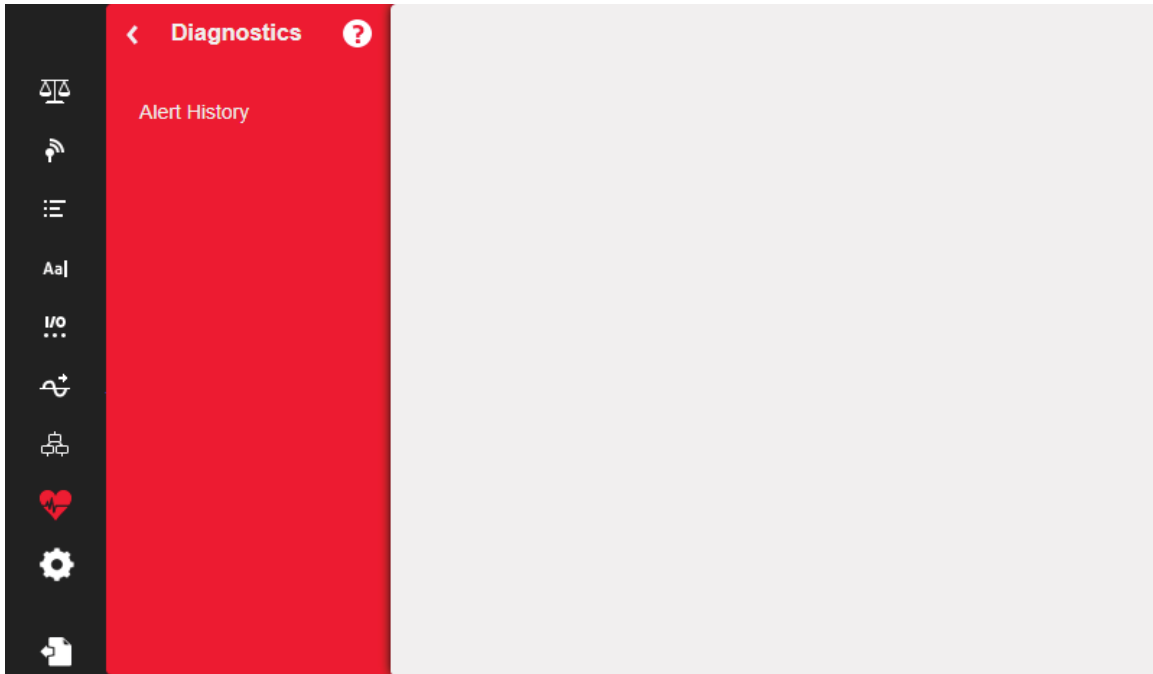

Figure 11-1. Diagnostics Menu

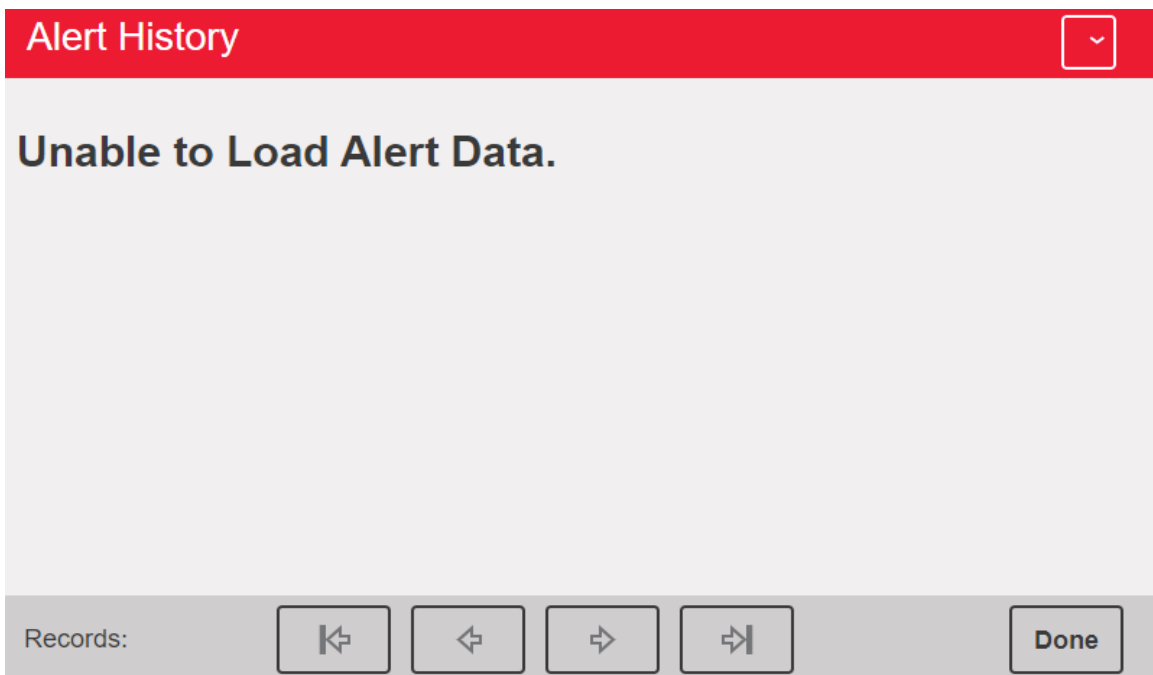



Figure 11-2. Alert History

## 12.0 System Settings

From the Configuration menu, select the **Systems Settings** icon (circled in [Figure 12-1](#)) to enter the Systems Settings menu.

Once all settings are correct, select  to return to weigh mode.

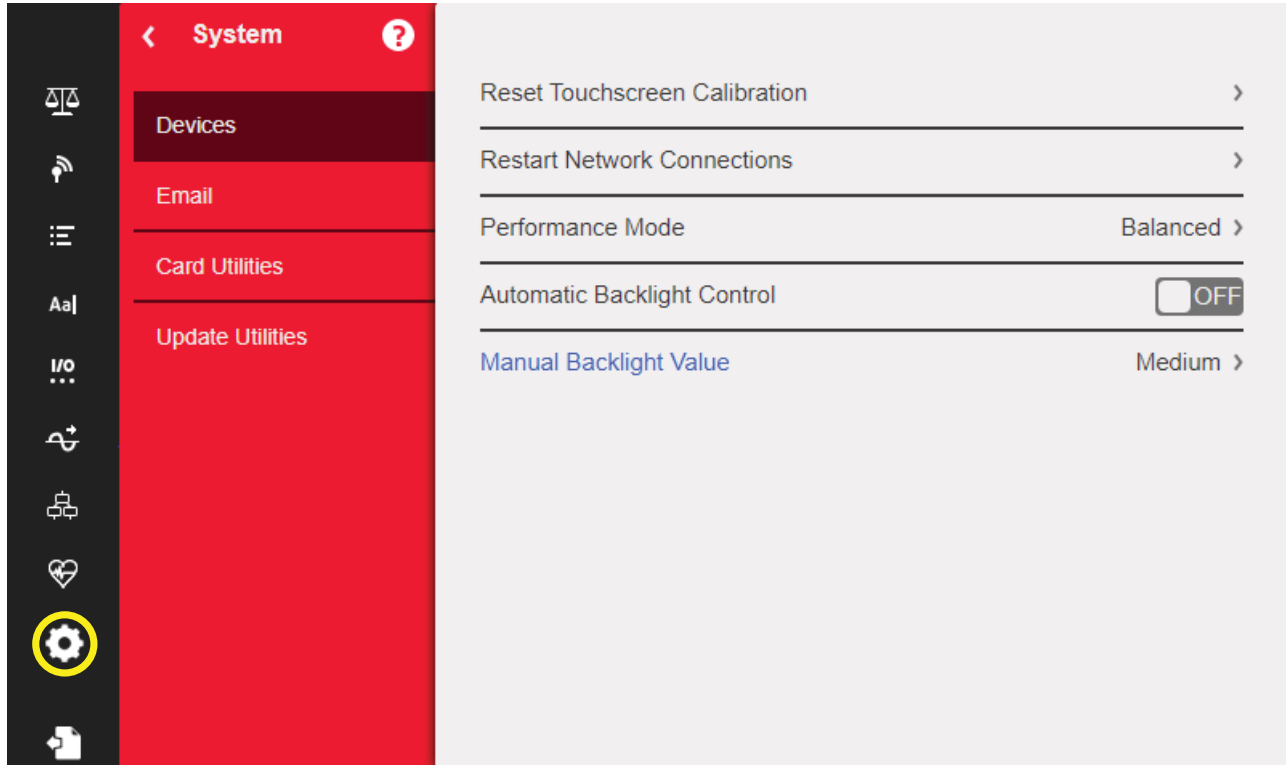

Figure 12-1. System Settings Menu

Parameter	Description
Devices	To set Devices parameters, see <a href="#">Section 12.1 on page 119</a>
Email	To set Email parameters, see <a href="#">Section 12.2 on page 120</a>
Card Utilities	To set Card Utilities parameters, see <a href="#">Section 12.3 on page 121</a>
Update Utilities	To set Update Utilities parameters, see <a href="#">Section on page 123</a>

Table 12-1. System Settings Menu Parameters

## 12.1 Devices

The Devices menu allows the recalibration of the touch screen and setting of performance mode..

Parameter	Description
Reset Touchscreen Calibration	Select <b>Yes</b> to enable Reset Touchscreen Calibration on the next indicator restart
Restart Network Connections	Select <b>Yes</b> to restart all network connections upon exiting configuration
Performance Mode	Select <b>Balanced Mode</b> for overall system optimized performance; User interface will be more responsive; default setting Select <b>Fast Control</b> for prioritized SmartCard and I/O based system performance; this may make user interface less responsive. <b>NOTE: When switching modes, the indicator will reboot</b>
Automatic Backlight Control	Select <b>On</b> to enable the Automatic Backlight Control; if set to Off, a Manual Backlight Value parameter displays, allowing a light value to be manually set to Low, Medium or High

Table 12-2. Devices Menu

### Touchscreen Calibration



**NOTE: Touchscreen Calibration is required after a firmware update, or follow the directions below if the viewing angle requires a new calibration.**

1. Press **Reset Touchscreen Calibration**.
2. Press **Yes** to calibrate the touchscreen on the next indicator restart.



Figure 12-2. Reset Touchscreen Calibration Prompt

3. Press **Yes** to restart the indicator. The indicator test runs. At 50% complete, the calibration utility displays.

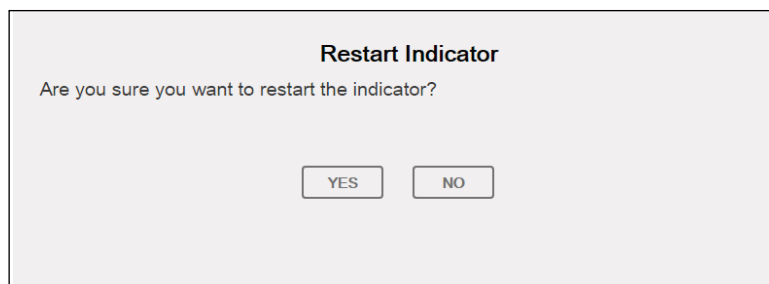

Figure 12-3. Restart Indicator Prompt

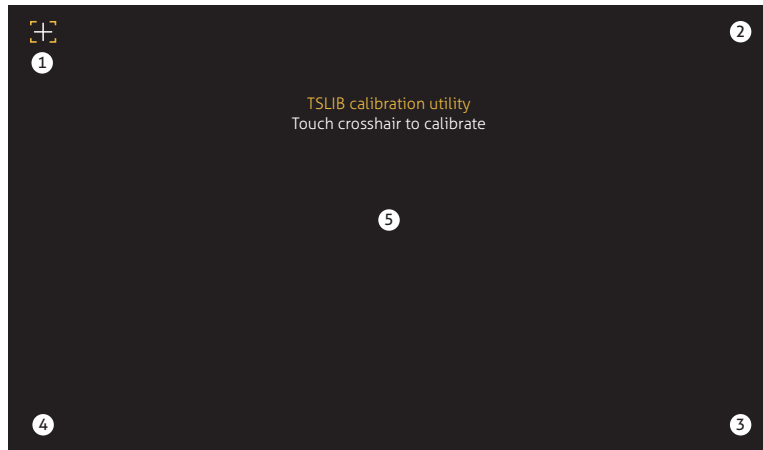

Figure 12-4. Calibration Utility Display

4. Touch each cross hair (five total) with a stylus or similar object when prompted. When the center cross hair has been touched, allow the indicator test to continue until the main menu displays.



**IMPORTANT:** Be very precise while calibrating the touchscreen. It is recommended to use a stylus or similar object to touch each cross hair, as this provides the greatest accuracy. Do not use a finger to calibrate the virtual keypad.



**NOTE:** If the screen becomes inoperable or there is no access to the Devices menu, press the configuration button. Type the code 9171 on the numeric keypad and press Clear. Cycle power the indicator and follow the steps above. There is no response from the screen until the power has been cycled.

Alternatively, the user can send a REMOVE.TSCAL serial command to the 1280 to prompt for a touch screen recalibration after the next power cycle.

## 12.2 Email

Print format data strings can be emailed from the 1280 Indicator directly to a specified email account. Email is used in an iRite program (see iRite manual PN67888) or is set in the Print Formatting menu (See [Section 7.1 on page 93](#)). If enabled, the 1280 Indicator sends an email to the specified address when a print format has the print destination set for email. The print format information is included in the body of the email. Email can be configured to send any of the print formats with any instance that triggers the 1280 to print.

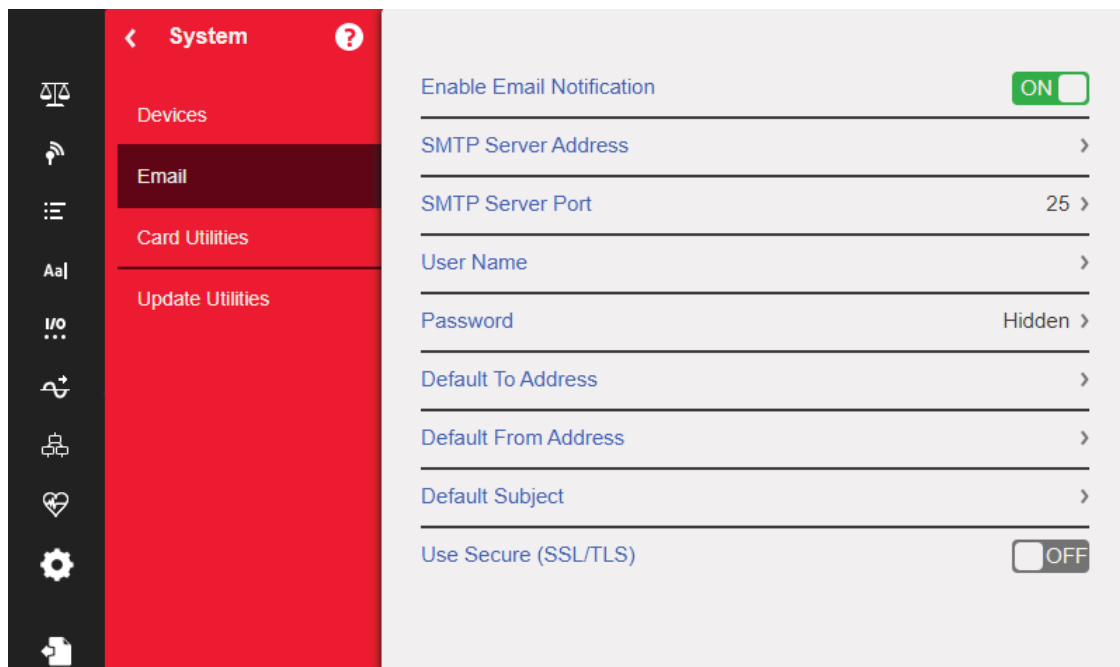

Figure 12-5. Email Menu





**NOTE: Networking must be enabled — either wired or WiFi.**

**Print destination must be configured for email.**

**Contact system administrator for email server settings. Settings will be different for each location and network.**

**Ensure the date and time set in the 1280 are current. See [Table 1-1 on page 11](#) to set date and time.**

**Some Email servers may utilize the UTC time zone. This may result in timestamp discrepancies.**

Parameter	Description
Enable Email Notification	Select <b>ON</b> to allow for email to be sent from indicator
Server Address	Address of SMTP email server to be used to send email <b>NOTE: Address does not include web protocol; example address: smtp.exampleemailclient.com</b>
Server Port	Port used to connect to above SMTP server
User Name	User name of email account on above SMTP server
Password	Password of above user
Default To Address	Recipient address used when email is sent
Default From Address	Sending address used when email is sent
Default Subject	Subject used when email is sent
Use Secure (SSL/TLS)	Select <b>ON</b> if email server has secure access configured

Table 12-3. Email Menu Parameters

## Setting up Email

In order for email to properly function, three separate settings in the following menus must be configured correctly.

- **Communications > Ethernet** must be configured to **Wired** or **Wi-Fi** and must have access to a functioning email server. (See [Section 5.2 on page 75](#))
- **Format > Print Formats > Destination** must be configured to **Email**. (See [Section 7.1.2 on page 94](#))  
**NOTE: Email can be set as the destination for any of the print formats.**
- **Diagnostics > Email** must be configured with email server information to authenticate email path. (See [Section 12.2 on page 120](#))



**IMPORTANT: Settings will be different for each location and network. All settings must follow local protocols. Refer to your system administrator and email client to configure all settings.**

**Rice Lake Weighing System technical support does not have the ability to configure email setup without the specific parameters from the SMTP system administrator.**

## 12.3 Updating the A/D Scale Card Firmware

See the below table for identifying characteristics and sources of further information on the two generations of A/D scale cards.

Card Generation	Channels	Card PN	Identifying Characteristics	Installation Add. No.	Flash Instructions
First Generation (discontinued)	Single	164085	green circuit board, slide switch, one scale channel	164652	<a href="#">Section 12.3.1 on page 122</a>
	Double	164683	green circuit board, slide switch, two scale channels	164653	
Second Generation	Single	220026	blue circuit board, push button, one scale channel	220040	<a href="#">Section 12.3.2 on page 123</a>
	Double	220027	blue circuit board, push button, two scale channels	220039	

Table 12-4. Scale Card Identification Information



**NOTE: A USB cable, with type A connection on one end and micro connection on the other, is required to re-flash either scale card. Ensure cable is available, once existing firmware is erased it cannot be recovered.**

### 12.3.1 First Generation Scale Card Firmware Loading Procedure

Follow the steps below to update scale card firmware:



**IMPORTANT:** If this process is not followed as described below, including power cycling, the scale card could be damaged and need to be replaced.

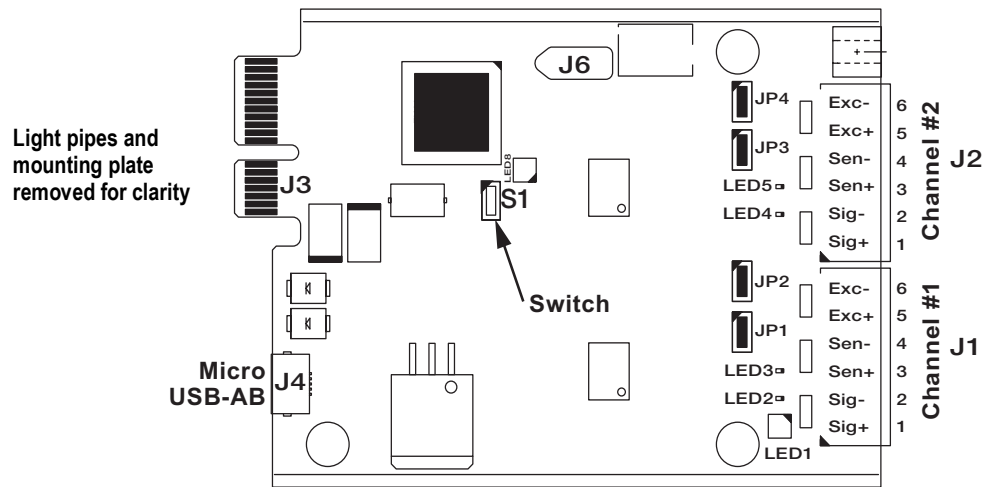



Figure 12-6. First Generation Single and Dual A/D Scale Cards

1. Enter the Diagnostics menu.
2. Press **Erase Card Utility**, then select the slot containing the scale card to be erased.
3. Press **Erase Card**. A flashing red LED on the card indicates the card's existing firmware has been erased and that it is ready to be flashed with new firmware.
4. Power down the 1280.
5. Remove the scale card from the 1280.
6. Using a USB cable (with type A connection on one end and a micro connection on the other) (See [Figure 12-6](#)), connect the scale card to the 1280 CPU board.
7. Power up the 1280.
8. From the configuration menu, select the **Diagnostics** icon  to enter the Diagnostics menu.
9. Press **Flash Card Utility** and select the firmware to be flashed.
10. Press the **Flash Card**. A flashing green LED on the card indicates the card has been flashed with new firmware. The process will take several seconds to complete.
11. Once successful confirmation appears, power down the 1280.



**IMPORTANT:** If the 1280 is not powered down at this point, the scale card could be damaged and need to be replaced.

**The 1280 must be power cycled before updating another scale card.**

12. Reinstall the scale card and power up the 1280.

### 12.3.2 Second Generation Option Card Firmware Updating Procedure

The second generation option card firmware updating process is robust and built into the microcontroller. If the process fails or a step is skipped, the hardware is not affected. Return to step 2 and repeat the process.



**NOTE:** This process is same across second generation cards. Scale card is used as an example.

The state of the LEDs on the card do NOT change during the installation steps.

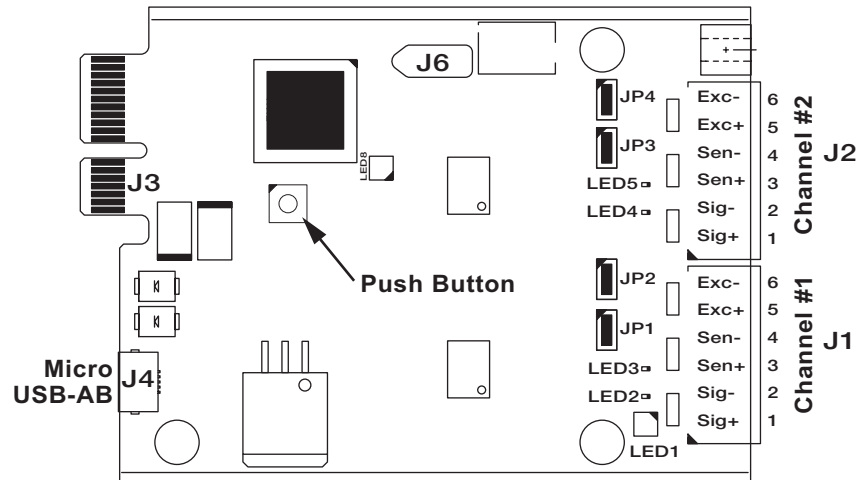

Figure 12-7. Second generation Single and Dual A/D Scale Cards

1. Download the second generation option card firmware \*.bin file from the website to your PC.
2. Power down the 1280.
3. Remove the second generation option card from the 1280.
4. Attach the USB cable into PC.
5. Locate the push button on the card near the 1280 backplane connector.
6. While holding down the card's push button, plug the USB micro end into the J4 connector (see [Figure 12-7](#)). PC detects a removable USB device called *CRP DISABLD*.
7. Release the push button after the USB device displays.
8. Access the newly attached device on the PC using a program such as Windows File Explorer.
9. Select the file **firmware.bin** and delete it.
10. Drag and drop to copy the downloaded second generation option card firmware to the attached device. Allow file to complete transfer.
11. Disconnect the drive in File Explorer.
12. Remove the USB cable connected to the second generation option card.
13. Disconnect the USB cable from the PC.
14. Unplug the USB cable from the second generation option card.
15. Replace the second generation option card into the same 1280 slot it was removed from.
16. Power up 1280.

## 13.0 Option Cards

The 1280 can host up to six option cards. The option cards can be installed in any of the six available option slots. The cards cannot be installed or removed when power is applied to the indicator (cards cannot be hot swapped).



**CAUTION:** *Electrostatic sensitive device (ESD), observe handling precautions to prevent shock or damage caused from electrostatic discharge.*



**WARNING:** *Failure to heed the following statements could result in serious injury or death.*

- *Use a wrist strap for protection and damage to components from electrostatic discharge (ESD) when working inside the indicator enclosure.*
- *Procedures requiring work inside the indicator must be performed by qualified service personnel only.*

Detailed information about each option card is in an addendum included with each card. The available 1280 option card kit part numbers and their corresponding addendum part numbers, are as follows:

Option Cards	Kit Part No.	Addendum Part No.
Single Channel Scale Card	164085	164652
Dual Channel Scale Card	164683	164653
24-Channel Digital I/O Card	164684	164654
Dual Channel Serial Communications Card	164685	164655
Single Channel Analog Output Card	165366	164656
Dual Channel Analog Output Card	164686	
Dual Channel Analog Input Card	164687	164657
Four Channel Relay Card	164689	164659
Single Channel EtherNet/IP™ Interface	165792	156861
Dual Channel EtherNet/IP™ Interface	208129	200276
DeviceNet® Interface	165793	156783
ProfiNet® Interface	165794	156781
Profibus® Interface	165795	156784
Modbus TCP® Interface	165796	156782
EtherCAT Interface	179533	164394

Table 13-1. Available Option Cards



**NOTE:** *The 1280 Fieldbus Card Firmware has been updated to add support for the iRite fieldbus handler.*

### 13.1 Hardware Serial Command

The **HARDWARE** serial command can be used to verify all of the installed option cards are recognized by the system.

The **HARDWARE** command returns a string of card type codes representing the cards the system recognizes as being installed in slots 1–6. The format of the returned string is xx, xx, xx, xx, xx, xx where xx is one of the following codes:

FF = No card installed	99 = Single Channel Analog Output card
10 = Single Channel Scale card	90 = Dual Channel Analog Output card
11 = Dual Channel Scale card	B1 = Dual Channel Analog Input card
20 = Digital I/O card	AA = Fieldbus card (with any module)
55 = Relay card	
61 = Serial Communications card	

### 13.2 Option Card Firmware

The OPTVERSION#s serial command, where s is the slot number, can be used to return the version of the firmware installed on the option cards. If the command returns NO CARD then either there is not a card installed or the installed card in the slot specified is not recognized by the system. Alternatively, a DUMPVERSIONS command returns the versions of all installed option cards.



**NOTE:** *Only applies to second generation option cards (see [Section 12.3.2 on page 123](#)).*

## 14.0 Importing/Exporting

The Revolution utility provides a suite of functions used to support configuration, calibration, customization and backup of the 1280 software. Hardware and software configuration, stream and ticket formatting, and database management are all supported by Revolution.

### Hardware and Software Requirements

- Minimum system requirements: 166 MHz, x86-compatible, with 32 MB RAM (64 MB for NT4/2000/XP), 40 MB disk space
- Recommended system: 233 MHz, x86-compatible or greater, with 64 MB RAM, 300 MB disk space

Revolution runs on most Windows® operating systems, including Windows Vista SP2, Windows 7 SP1, Windows 8.1 and Windows 10 (both 32-bit and 64-bit architectures are supported).

System requirements to run Revolution are as follows:

- 1 GHz CPU (x86-32-bit or x86-64-bit)
- 512 MB RAM
- 850 MB disk space (32-bit) or 2 GB disk space (64-bit)

Files which can be imported and exported to/from the 1280 indicator include:

- **Configuration** – .rev file extension, which are scale configuration, communication, setpoint, print format, database schemas or displayed widgets settings created in the Revolution configuration software
- **iRite Programs** – .cod extension which is a compiled version of a source code file (.src extension); iRite is import only
- **Database** – .db extension which are the actual data records which can populate a database schema

### Definitions

**Export** – pulling information from the 1280 to a file system to save as one of the two types of files.

**Import** – sending information to the 1280 from a previously saved file system.

## 14.1 Importing Configuration



**IMPORTANT:** *Importing a configuration overwrites the existing configuration.*

There are several ways to upload a Revolution file to the 1280:

- From the onboard file system (included applications)
- Save the .rev file to a flash drive and import it into the 1280 from the USB port
- Save the .rev file to a micro SD card and importing it into the 1280 from the micro SD card Slot
- Connect to the 1280 from a PC which has Revolution open and is connected to any COM port (USB, Ethernet or Serial), see [Section 14.7 on page 130](#)

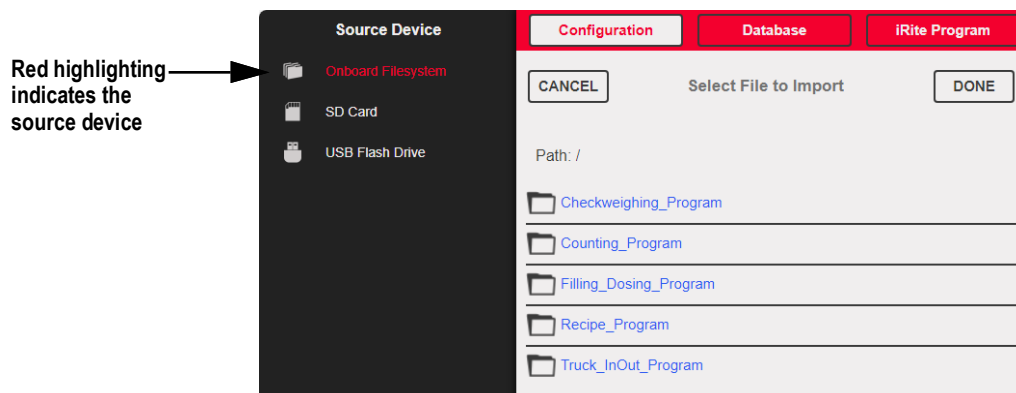





Figure 14-1. Import Configuration



**NOTE:** *The Import Configuration screen looks the same whether importing from an onboard file system, a micro SD card or a flash drive. The only difference is the source device is highlighted in red on the left side of the screen. For an example, see [Figure 14-1](#), a file is being imported from an onboard file system.*

### 14.1.1 Importing Built-in iRite Configuration



1. Press  to enter the Configuration menu.
2. Press **Import from File**. The Import Screen displays, see [Figure 14-1 on page 125](#). Load both the .rev and .cod files to use the built-in application programs.
3. Select **Onboard Filesystem**.
4. Select configuration file.
5. Select one of the programs.
6. Press  to import.
7. Press .

### 14.1.2 Importing Revolution Files from a Flash Drive or Micro SD Card

1. Save the Revolution file to the flash drive or micro SD card.
2. Insert the flash drive into either USB port on the indicator, or the micro SD card into the 1280's designated micro SD card slot.
3. Press  to enter the Configuration menu.
4. Select **Import from File**. The Import Screen displays, see [Figure 14-1 on page 125](#).



**IMPORTANT:** Importing a configuration overwrites the existing configuration.

5. Select **Flash Drive** or **SD Card** (depending on which one is being used). This reads the file system and display available folders.
6. Select **Configuration** to filter out the .rev files which are stored on the flash drive.
7. Navigate to the folder then the .rev file. Press .
8. The Revolution file settings are now downloaded to the 1280. Press .



## 14.2 Importing iRite™ Programs

There are several ways to load an **iRite** user program into the 1280.

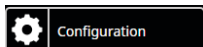

However, there is no way to upload/export an **iRite** user program to prevent fraud.

- Import one of the four built-in **iRite** applications (truck in/out, checkweighing, recipe batching, or counting) stored in the 1280's memory
- Import the **iRite** program (.cod file) stored on a flash drive
- Import the **iRite** program stored on a micro SD card
- Send **iRite** Configuration files to the 1280 from a PC which has Revolution open and is connected to any COM port (USB, Ethernet or Serial), see [Section 14.7 on page 130](#)

### 14.2.1 Importing Built-in iRite Programs

1. Press  to enter the Configuration menu.
2. Press **Import from File**. The Import Screen displays, see [Figure 14-1 on page 125](#).
3. Select **Onboard Filesystem**.
4. Select **iRite Program**.
5. Select one of the programs.
6. Press  to import.
7. Press .

### 14.2.2 Importing iRite from a Flash Drive or Micro SD Card

1. Save the iRite file to the flash drive or a micro SD card.
2. Press  **Configuration** to enter the Configuration menu.
3. Press **Import from File**. The Import Screen displays, see [Figure 14-1 on page 125](#).
4. Select **Flash Drive** or **SD Card** on the left of the display.
5. Select **iRite Program** on the top of the display.
6. Navigate to the folder where the desired .cod file is stored and select the file.
7. Press  to import.
8. Press .

### 14.2.3 Send Configuration from Revolution to Device

 **NOTE:** If RS-485 Network or TCT/IP Network are selected as the default communication mode, a prompt to select an address displays before it tries to connect to the 1280, see [Section 14.7 on page 130](#) for Revolution connection instructions.

1. Press the **Connect** icon in the tool bar, see [Section 14.7 on page 130](#). If communications need to be adjusted, select Options from the Tools menu.
2. Press  **Configuration** on the indicator.
3. In Revolution, from the **Communications Menu**, select **Send Configuration to Device**. A menu box displays.

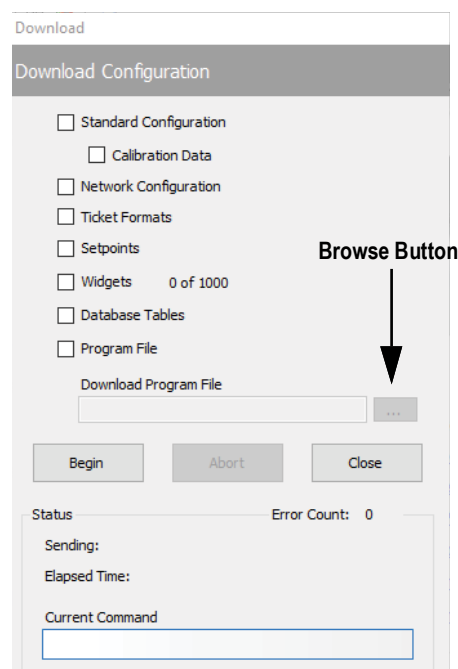



Figure 14-2. Import Configuration



4. Mark the check boxes corresponding to sections to be downloaded.
5. If the iRite program is to be downloaded, press the **Browse** button to bring up the PC file system. If not, skip to [Step 7](#).
6. Navigate to the saved .cod file. The selected path should be displayed in the white text box.
7. Press **Begin** and wait for the download to complete. Settings from the Revolution file are now populated in the 1280.
8. Press .

## 14.3 Importing Database Data

To load many records of data quickly (transaction data, product or customer data) all rows can be loaded into the 1280 database schema at once. The database schema is part of the Configuration and must be downloaded before actual data is sent. There are three ways to import data.

- Download a previously saved or exported .db file stored on a flash drive
- Download a previously saved or exported .db stored on a micro SD card
- Connect to the 1280 from a PC which has Revolution open and is connected to any COM port (USB, Ethernet or Serial)

### 14.3.1 Importing Databases from a Flash Drive or Micro SD Card

1. Insert a flash drive or a micro SD Card into the 1280 with a saved .db file (a text file with a special extension, which was previously exported pipe-delimited file of records).
2. Press  **Configuration** to enter the Configuration menu.
3. Press **Import from File**.
4. Select **Flash Drive** or **SD Card**.
5. Select **Database** on the top of the display.
6. Navigate to the folder where the desired .db file is stored and select the file.
7. Press  to import.
8. Press .

### 14.3.2 Downloading Databases to the 1280

1. Open the Revolution file with the desired (previously downloaded) database schemas.
2. Press the **Connect** icon in the tool bar. If communications need to be adjusted, select **Options** from the **Tools** menu.
3. Navigate to the **Database Editor** in Revolution and select the database name (in the middle) to be populated.
4. A grid as many columns wide as there are fields, and as many rows down as the records display.  
Options to populate this grid are:
  - Import a previously saved .db file stored on the PC to the Database Editor by pressing on the **Import** icon
  - Type all the data in the Database Editor
5. Click on the **Download** icon.

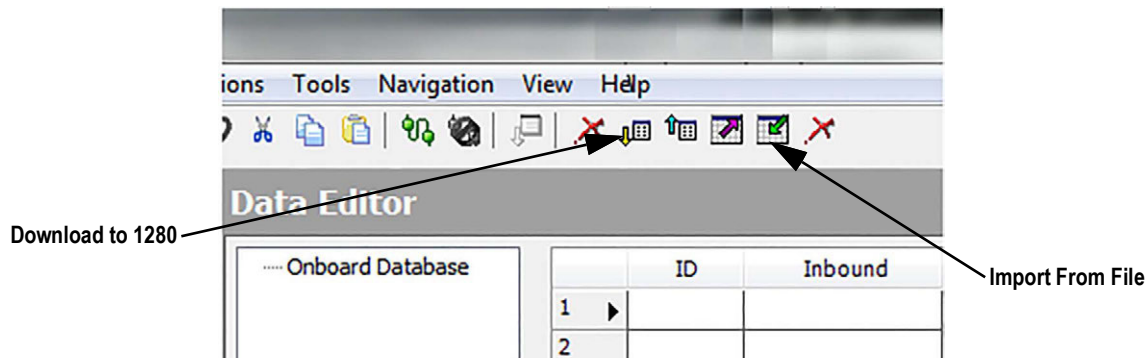

Figure 14-3. Database Commands in Revolution

The data in the Data Editor is sent one at a time to the 1280. This data is appended to any existing data in the 1280.



## 14.4 Exporting Configuration

It is important to save a copy of the file to create a backup version of the Configuration. There are three ways this can be done.

- Upload the configuration to be saved as a .rev file on a flash drive
- Upload the configuration to be saved as a .rev file on a micro SD card
- Get Configuration from the 180 using a PC which has Revolution open and is connected to any COM port (USB, Ethernet or Serial)



**NOTE:** Configuration parameters changes (from same configuration session) must be saved prior to exporting configuration.

### 14.4.1 Exporting to Flash Drive or Micro SD Card

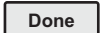
1. Insert the flash drive or the micro SD card into the indicator.
2. Press  to enter the Configuration menu.
3. Press **Export to File**. The Export Screen displays.
4. Select **Flash Drive** or **SD Card**, which reads the file system and display folders.
5. Select **Configuration** to indicate the configuration should be saved as a .rev file.
6. Navigate to the folder where the file is to be stored. Press .

### 14.4.2 Get Configuration From Device to Revolution



1. Open Revolution software on the PC.
2. Press the **Connect** icon in the tool bar, see [Section 14.7 on page 130](#).
3. Press  on the indicator.
4. Select **Communications** then **Get Configuration from Device**. A menu box displays.
5. Navigate to the folder on the PC where the configuration file is to be stored.

## 14.5 Exporting Database Data

To keep a backup version of the databases (transaction data, product or customer data) it is important to save a copy of the database file. There are three ways this can be done.

- Upload the database to be saved as a .db file on a flash drive
- Upload the database to be saved as a .db file on a micro SD card
- Connect to the 1280 from a PC which has Revolution open and is connected to any COM port (USB, Ethernet or Serial)

### 14.5.1 Exporting Database to Flash Drive or Micro SD Card



1. Once the data has been saved on the 1280 (through iRite during run mode, or after a previous download of data), insert a flash drive or micro SD card into the indicator.
2. Press  to enter the Configuration menu.
3. Press **Export to File**.
4. Select **Flash Drive** or **SD Card**, which reads the file system and displays available folders.
5. Select **Database** to indicate the database data is to be stored as a pipe-delimited .db file.
6. Navigate to the folder location where the .db file is to be stored.
7. Press  to select and export.

### 14.5.2 Saving Databases from the 1280 to a PC

1. Open Revolution on the PC.
2. Open the specific .rev file with the specified database schema's used in the 1280.
3. Press the Connect icon in the tool bar, see [Section 14.7](#).
4. Navigate to the **Database Editor** in Revolution and click on the database name (in the middle) which is about to be populated.
5. A grid displays which is as many columns wide as there are fields, and as many rows down as there are records.
6. Click on the **Upload** icon.
7. The data displayed in the Data Editor is not saved. To save the database to the PC, click on the **Export** icon.
8. The file system box displays asking where to save the file on the PC and what to name the file.

### 14.6 Exporting Diagnostic Log

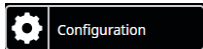
An iQUBE<sup>2</sup> error log report is generated and can be sent to the host device. Use the following steps to export the error log:

1. Once the data has been saved on the 1280 (through iRite during run mode, or after a previous download of data), insert a flash drive or micro SD card into the indicator.
2. Press  to enter the Configuration menu.
3. Press **Export to File**.
4. Select **Flash Drive** or **SD Card**, which reads the file system and displays available folders.
5. Select **Database** to indicate the database data is to be stored as a .txt log file.
6. Navigate to the folder location where the .db file is to be stored.
7. Press  to select and export.

### 14.7 Connecting to the Indicator from Revolution

1. Connect the PC to any of the 1280 COM ports (USB, Ethernet or Serial).
2. Open Revolution on the PC.
3. Press  to enter the Configuration menu.
4. Click on the **Connect** icon in the tool bar. Revolution attempts to establish communications to the indicator.

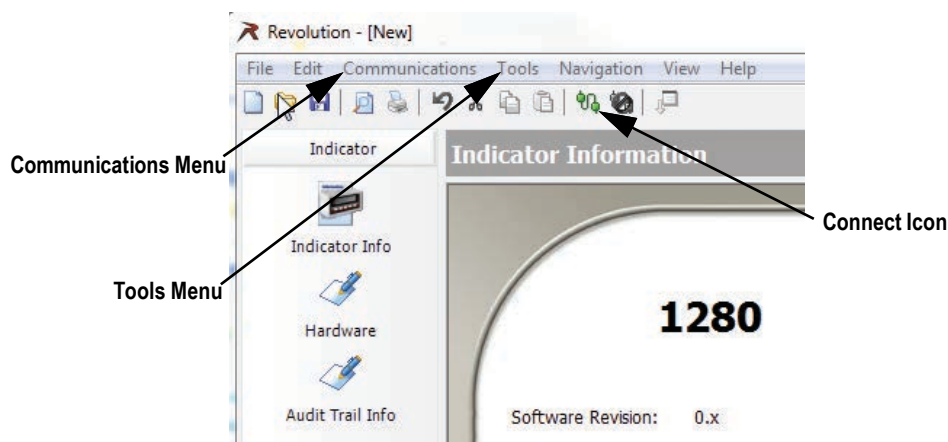

Figure 14-4. Connect to Computer

- If communications settings need to be adjusted, select **Options** from the Tools menu.

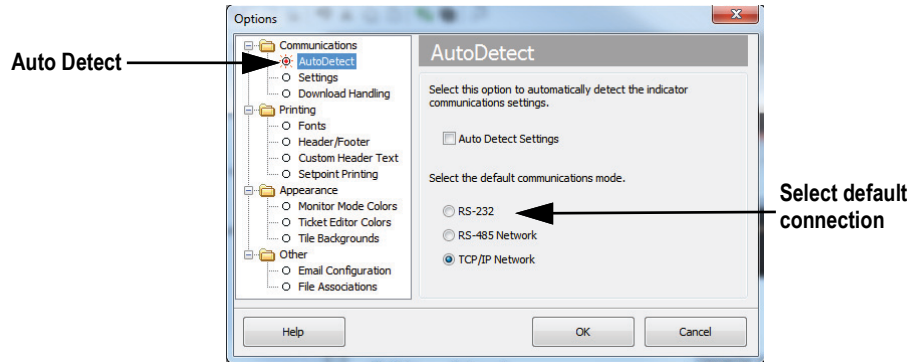

Figure 14-5. Set Connection Type

- From **AutoDetect**, select the type of connection to be made.



**NOTE:** A comport must be selected from the settings screen if using RS-232; however, baud, parity and data bits are only selectable if the Auto Detect Settings check box remains unchecked on the AutoDetect screen.

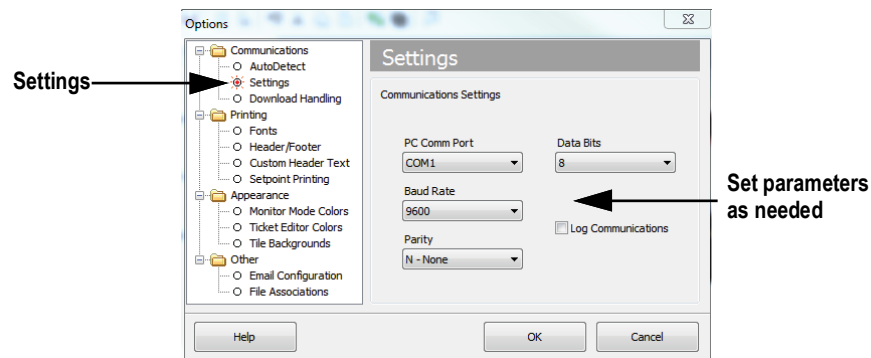

Figure 14-6. Set Communications Parameters

- Set the communication parameters as needed.

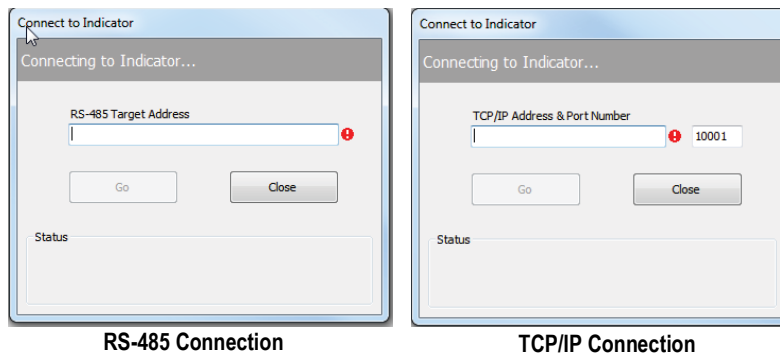

Figure 14-7. Connection Screens

- An address is required for connection to RS-485 or TCP/IP.

## 14.8 Current Firmware

For the latest version of the 1280 firmware go to [www.ricelake.com/1280](http://www.ricelake.com/1280).



**IMPORTANT:** Prior to loading new firmware, save existing configuration and/or databases by using the instructions earlier in this section. The firmware update resets the configuration to factory defaults.

- Make sure the unit has stable power during the firmware image update process.
- Do not remove power during the update process. The unit may become damaged and rendered non-functional.
- Do not tamper, modify or remove any of the firmware image files in the update directory. Doing so may render the unit non-functional.
- Do not jiggle or disturb the flash drive once the update process has started, as this may cause unforeseen issues.
- The update process takes a couple of minutes to complete. If there are no obvious results or errors after 4–5 minutes of the update process running, try again or contact technical support.

### 14.8.1 Check Current Firmware

Enter the configuration mode, the current firmware version loaded on the 1280 is displayed at the bottom of the screen.

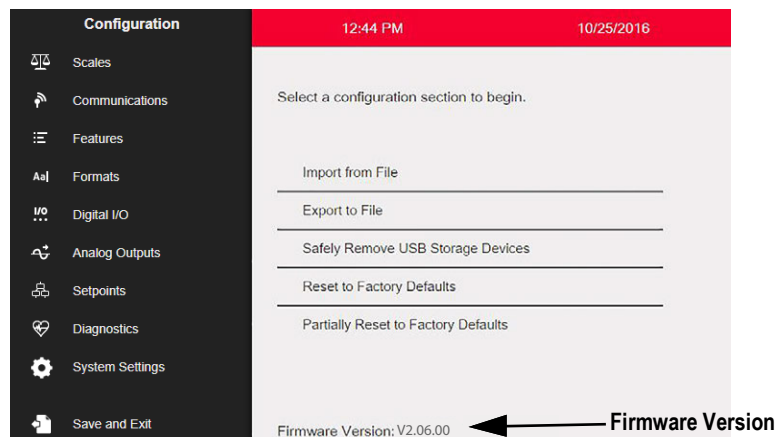

Figure 14-8. Check the Firmware Version

Compare the firmware version to the latest version available online at [www.ricelake.com/1280](http://www.ricelake.com/1280)

## 14.9 Updating Firmware with USB Flash Drive

### 14.9.1 Download Firmware to USB

- For the latest version of the 1280 firmware, go the Rice Lake website and search for 1280 firmware:
  - Select 1280 Enterprise
  - Select Resources/Downloads
  - Select Firmware and Download

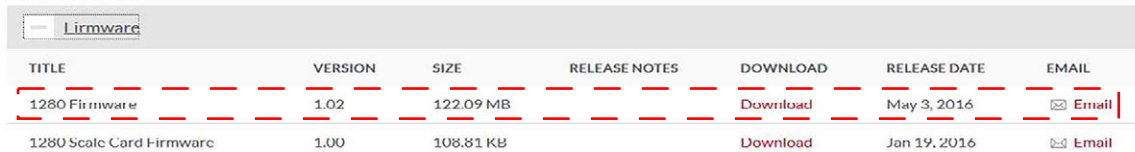

TITLE	VERSION	SIZE	RELEASE NOTES	DOWNLOAD	RELEASE DATE	EMAIL
1280 Firmware	1.02	122.09 MB		Download	May 3, 2016	Email
1280 Scale Card Firmware	1.00	108.81 KB		Download	Jan 19, 2016	Email

Figure 14-9. Select Firmware from the Website

- Download the firmware zip file to a PC and unzip the folder.
- Place a USB storage device (flash drive) into an available slot in the PC.
- Copy the **update** folder to the root level of the flash drive.



**NOTE:** If the update folder is not at the root level, the file cannot be found.

Delete any pre-existing update file from the flash drive.

### 14.9.2 Update Firmware to 1280



**IMPORTANT:** If updating to firmware to version 2.06.00, the system automatically reboots after installation and reflashes the firmware from the USB a second time. When finished, the 1280 reboots a second time; Calibrate touch screen displays.

Refer to [Section 14.10 on page 137](#) for instruction on updating firmware using the Network Update capability.

- Power down the 1280 to be updated.
- Place the flash drive, containing the firmware update, into the **USB A Port** on the 1280.
- Hold the setup switch while powering on the 1280 for 5–10 seconds or until **Initializing** is displayed. The 1280 is checking for the flash drive (this may take up to 12 seconds). Once the device is found the message '**update**' directory found on USB storage device displays.



Figure 14-10. Initializing – Firmware Update

- Press the USB button. **Verifying Files:** displays, when complete, **Update in progress** displays. This process takes a couple of minutes to complete. When the update process is complete, the system automatically reboots and returns to weigh mode.

The progress bar indicates the percentage of time completed.  
Once at 100% the program continues to the next step of installation.



Figure 14-11. Verifying Files

- Remove the flash drive at this time.

The updated firmware version number displays at the bottom of the initial setup screen. Each time the indicator is updated with new firmware, an **update.log** file is created in the update directory on the flash drive, if they are present.

### Example Update Log

(update\_full\_good.log)

```
Checking partitions...
*** Files ***
total 461712
-rwxr-xr-x 5792392 Jul 28 12:07 backup_ulmage
-rwxr-xr-x 256 Jul 28 12:07 backup_ulmage.sgn
-rwxr-xr-x 39035 Jul 28 12:07 imx6q-RLWS.dtb
-rwxr-xr-x 256 Jul 28 12:07 imx6q-RLWS.dtb.sgn
-rwxr-xr-x 1906 Jul 28 12:07 post_script.sh
-rwxr-xr-x 256 Jul 28 12:07 post_script.sh.sgn
-rwxr-xr-x 29846192 Jul 28 12:07 rootfs.cpio.uboot
-rwxr-xr-x 256 Jul 28 12:07 rootfs.cpio.uboot.sgn
-rwxr-xr-x 431011840 Jul 28 12:08 rootfs.tar
-rwxr-xr-x 256 Jul 28 12:08 rootfs.tar.sgn
-rwxr-xr-x 5 Jul 28 12:08 rootfs_drop
-rwxr-xr-x 257024 Jul 28 12:08 u-boot-01.imx
-rwxr-xr-x 256 Jul 28 12:08 u-boot-01.imx.sgn
-rwxr-xr-x 5792392 Jul 28 12:08 ulmage
-rwxr-xr-x 256 Jul 28 12:08 ulmage.sgn
-rwxr-xr-x 37 Jul 28 12:08 update.log
*** Files ***
```

```
*****
** Digital Signature Verification Of All Update Files **
*****
U-Boot...
Checking signature ...OK
Device tree binary...
Checking signature ...OK
Linux Kernel...
Checking signature ...OK
Backup Linux Kernel...
Checking signature ...OK
Post Install Script...
Checking signature ...OK
Recovery FS...
Checking signature ...OK
Root FS...
Checking signature ...OK
*****
** Digital Signature Verification Of All Update Files **
** Finished **
*****
```

Figure 14-12. Update Log Example

### 14.9.3 Errors

If the flash drive is not found, the initialization fails.

#### USB Storage Device Not Found

When unable to detect the flash drive after the full wait time, the following displays.

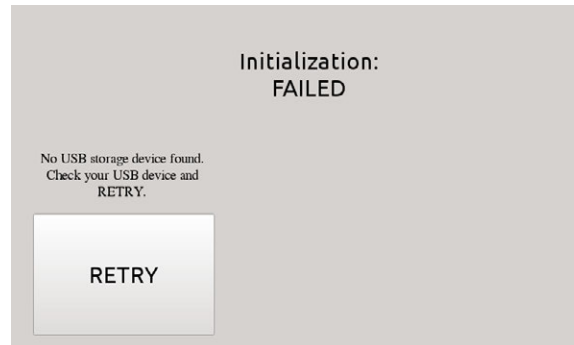

Figure 14-13. USB Storage Device Not Found

#### Solution

- Verify the flash drive is properly plugged into one of the two USB ports; only one device can be plugged into these ports during the update process
- Make sure the flash drive is formatted as a FAT32 file system. NTFS is not recognized
- Try another flash drive, the first one may be faulty
- If the issue continues, it may be a faulty USB port, please contact technical support for further assistance

#### Update Directory Missing

The update directory does not exist on the flash drive.



Figure 14-14. Update Directory Not Found

#### Solution:

- Verify the **update** directory containing the firmware image update files exists at the root level of the flash drive
- Verify the path to the **update** file is correct

Example of a correct USB PC type path: `F:/update/firmware_files`

Example of an incorrect USB PC type path: `F:/xdirectory/update/firmware_files`

## Digital Signature

Digital signature verification of firmware image file/files failed.

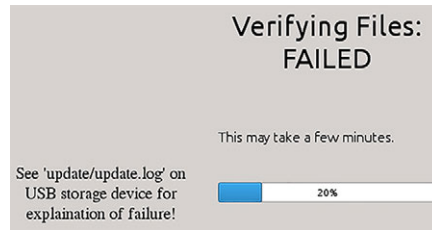

Figure 14-15. Digital Signature Failure

**NOTE:** It is safe to disconnect power from the indicator and remove the USB storage device when FAILED appears on the display. The uploading of new firmware does not begin until after Initialization and Verifying Files has been completed.

Sample log file with a digital signature verification file errors:

```

Bad signature and missing signature file.
(update_nosig_1bad.log)
Checking partitions...
*** Files ***
total 11636
-rwxr-xr-x 39035 Jul 29 14:41 imx6q-RLWS.dtb
-rwxr-xr-x 256 Jul 29 14:41 imx6q-RLWS.dtb.sgn
-rwxr-xr-x 1906 Jul 29 14:41 post_script.sh
-rwxr-xr-x 256 Jul 29 14:41 post_script.sh.sgn
-rwxr-xr-x 5792392 Jul 29 14:41 rootfs.tar
-rwxr-xr-x 256 Jul 29 14:41 rootfs.tar.sgn
-rwxr-xr-x 257024 Jul 29 14:41 u-boot-01.imx
-rwxr-xr-x 256 Jul 29 14:41 u-boot-01.imx.sgn
-rwxr-xr-x 5792392 Jul 29 14:41 ulmage
-rwxr-xr-x 37 Jul 29 14:41 update.log
*** Files ***

*****
** Digital Signature Verification Of All Update Files **
*****

U-Boot..
Checking signature ...OK
Device tree binary...
Checking signature ...OK
ulmage.sgn not found ...FAIL
backup_ulmage not found.
SKIPPING..
Post Install Script...
Checking signature ...OK

rootfs.cpio.uboot not found.
SKIPPING..
Root FS...
Checking signature ...FAIL
*****
** Digital Signature Verification Of All Update Files **
** Finished **
*****

***** FILE VERIFICATION STATUS *****
u-boot-01.imx Verified
imx6q-RLWS.dtbVerified
ulmage Missing Sgn
post_script.sh Verified
rootfs.tar Verify Failed
***** FILE VERIFICATION STATUS *****

-----
!! File Verification Failure !!
!! NO files were flashed to the device !!
-----

!!!!!!!!!!!!!!!!!!!!!!!!!!!!!!!!!!!!!!!!!!!!!!!!!!!!!!!!!!!!!!!!!!!!!!!!!!!!
!! !!
!! For more information about errors, see the manual. !!
!! !!
!!!!!!!!!!!!!!!!!!!!!!!!!!!!!!!!!!!!!!!!!!!!!!!!!!!!!!!!!!!!!!!!!!!!!!!!!!!!

```

Figure 14-16. Digital Signature Failure Example



Error	Troubleshooting Steps
Corrupted zip file	Download and extract the zip file again
Corrupted copy/writing of <b>update</b> directory to flash drive	Ensure the flash drive has been synced and is safely detached before disconnecting it from the PC
Bad flash drive	Try another flash drive
Missing required file or signature file	Download and extract the zip file again
Files are corrupt or have been tampered with	Download and extract the zip file again

Table 14-1. Digital Signature Failure Errors

**IMPORTANT:** Do not tamper, modify or remove any of the firmware image files in the update directory. Doing so may render the unit non-functional.

## 14.10 Updating Firmware from the Network

Network Updates allow firmware to be downloaded from the company website via internet connection.

**IMPORTANT:** Flash firmware version 2.06.00 or newer to use this feature (see Section 14.9.2 on page 133).

Follow the procedure below to perform all future network updates:

1. From the Systems Setting menu, select Update Utilities (see Figure 14-17).

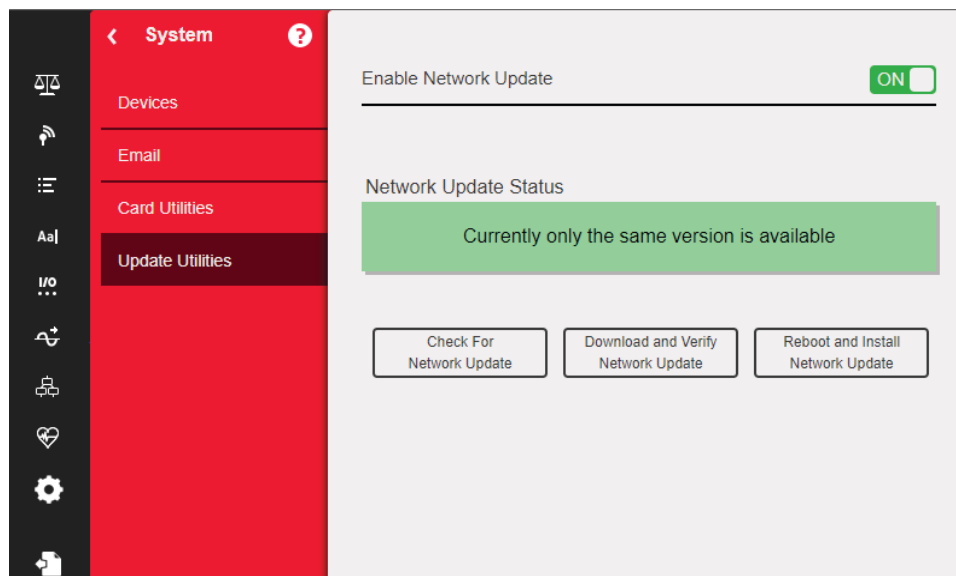

Figure 14-17. Network Updates Menu

2. Ensure the Enable Network Update is on.

**NOTE:** If network updates is enabled, user must save and exit the menu to proceed.

3. Press the **Check for Network Update** button. Update availability status displays.
4. If a new version is currently available, press the **Download and Verify Network Update** button.
5. When the new version has been downloaded successfully, press the **Reboot and Install Network Updates** button. 1280 will reboot and install the update.

**IMPORTANT:** Do not unplug or interfere with update process as it may render the device inoperable.

6. When update is complete, the 1280 will reboot again. System will return to the weight screen or iRite program start screen.

### 14.10.1 Errors

Error Message	Procedure
No network configured. Make sure a network connection and DNS are properly configured.	Enable the network and configure the Ethernet and wi-fi settings (see <a href="#">Section 5.2 on page 75</a> ).
Make sure a network connection and DNS are properly configured.	Manifest.txt may be corrupted or website may be down. Try again or contact phone support.
Downloaded update firmware zip image is corrupted.	Try again or contact phone support.

Table 14-2. Error Messages

### 14.10.2 Switch Firmware Versions



**NOTE:** This feature is only available in firmware versions 2.06 or greater.

The system will retain the 3 most recent firmware versions installed, starting with v2.06, in rolling fashion. Follow the procedure below to change firmware versions:

1. Hold the setup switch while powering on the 1280 for 5 to 10 seconds or until **Initializing** is displayed.
2. Once the device is finished checking for a USB flash drive and the buttons are activated, select **Support Tools**. Support Tools screen displays.



**NOTE:** The 1280 doesn't need a USB flash drive inserted to switch firmware versions.

3. Select **Change Version** button. Change Version Partition screen displays.



**NOTE:** The entry highlighted grey is the currently active version.

Change Version Partition				
Currently Active Version Is Highlighted Grey				
Partition Number	Firmware Version	Install Date	Firmware Build Date	Bootloader Version
1	2.06.00 bn:0016	10 Sep 2023 09:11:56	07 Sep 2023	4.05.00
2	2.06.01 bn:0003	18 Nov 2023 16:30:48	12 Nov 2023	4.05.00
3	N/A			

Change Version

Done

Figure 14-18. Change Version Partition Screen

4. Select the desired version. It will highlight blue.

5. Select the **Change Version** button. A warning screen displays.

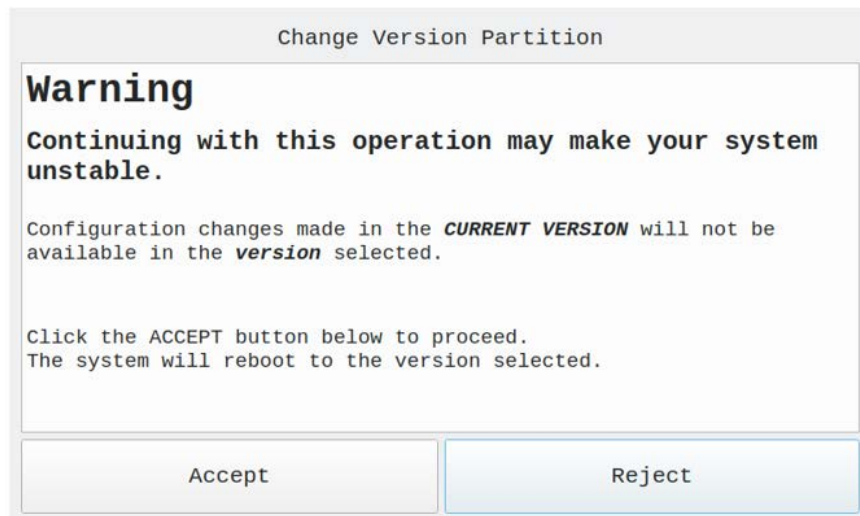

Figure 14-19. Warning Screen



**CAUTION:** Keep the following items in mind when making a selection.

- If SmartCards have been added, removed or moved from slots in this current version, it will likely create issues going to the version you selected.
  - If you have made any changes to configuration in this current version, those will NOT be present in the version you selected.
  - Your database is common to all versions loaded. If you changed your database scheme, added or removed a column in the current version, it will may no longer work with the selected version. It is recommended to backup or export your database to a USB storage device if concerned about that data's integrity (see [Section 14.5 on page 129](#)).
  - If you loaded a new iRite program in this current version, it will not be available in the version you selected.
6. Select **Accept**. The following message displays.

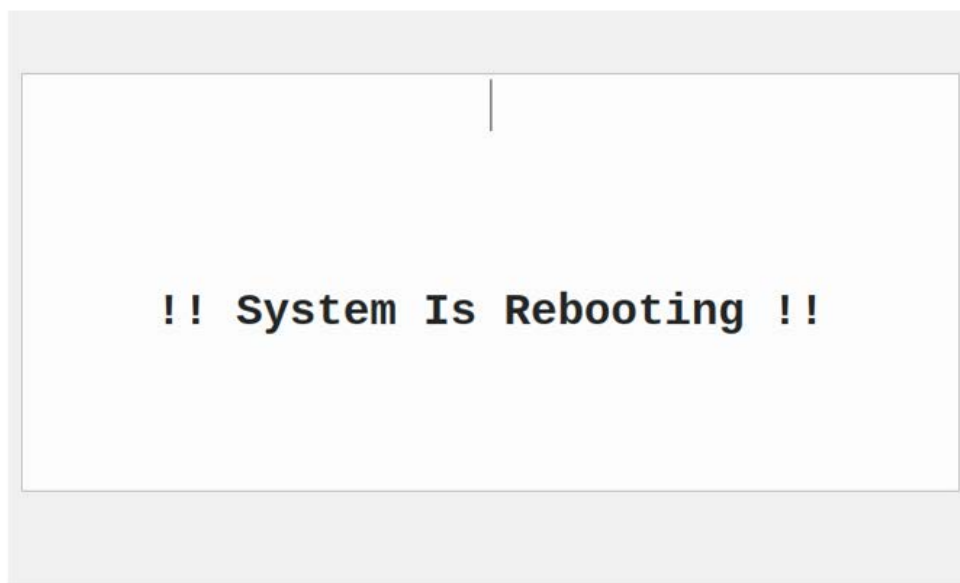

Figure 14-20. Reboot Message

When finished rebooting, the system will run the selected firmware version.



**NOTE:** If an iRite application was installed, the system may restart on its own or need to be restarted manually.

## 14.11 Visual Studio Code – iRite

This supports the iRite Language for Visual Studio Code.

- Syntax Colorization
- Snippets
- Preprocessing
- Compiling
- Deployment to Indicator

### Installation

1. Press  and enter **iRite**.
2. Press install and allow **VScode** to restart. The syntax highlighting and snippets are now available.

### Compilation and Deployment



**IMPORTANT:** Ensure Revolution is installed, if not, install it before continuing.

Press **iRite: Build**, an **irite.settings.json** file generates in the directory.

Defaults are established on build, but must be modified for the indicator being used.

Variable	Value
Method	TCP, RS232
Indicator	1280, 920, 880, 820
Ippaddress	If using TCP connection
Tcpport	
Comport	If using RS232
Baudrate	
Databits	
Parity	
Stopbits	

Table 14-3. Connection Parameters

### Deployment

Ensure the **irite.settings.json** file has been modified to the system specs and press **iRite: Deploy**.

## 15.0 Display Editor

The Display Editor allows the user to configure the splash screen and add widgets.

### 15.1 Configurable Splash Screen

The 1280 Enterprise supports a configurable splash screen during the boot up process (or sequence).

- Only PNG image files are supported
- The image to be used must be named **oem.png** and it has to be placed in the root folder of the SD card
- The graphic should be no larger than 800 x 480 pixels (7 in) and 1280 x 800 (12 in)

### 15.2 Widgets

The Display Editor, in Revolution, is the only way to add widgets. Widgets can be added on up to 99 different screens.

The type and location of elements the 1280 display are easily specified using the drag and drop features of the 1280 utility. However, display widgets can also be programmed using serial commands while the 1280 is in setup mode, or through iRite programming. Up to 99 different screens can be configured.

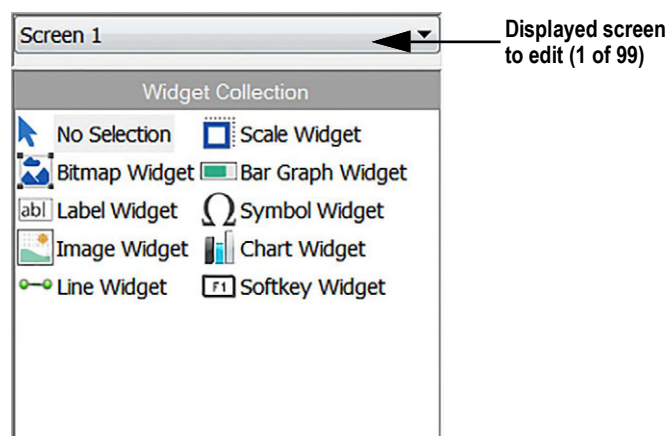

Figure 15-1. Widget Screen

- Scale Widgets are Legal for Trade representations of the configured scales in the system and include Center-of-Zero, Standstill, Tare and Units annunciators
- Bitmap Widgets are images of tanks or hoppers to add aesthetic value
- Bar graph Widgets are a representation of a percentage of whatever they are linked to
- Label Widgets are text boxes populated with whatever they are linked to/captioned
- Symbol Widgets are pictures with various states to display change, depending on what they are linked to
- Image Widgets display images stored locally on a micro SD card or remotely at a specific URL address
- Chart Widgets are used to visually graph data on the display
- Line Widgets are used as a separator for other widgets
- Softkey Widgets allow softkeys to be created and needed

Some widget types require the location or size of the widget be specified, in pixels. [Figure 15-2](#) and [Figure 15-3](#) display the pixel counts (133.33 pixels per inch) used to specify the pixel location on the display.

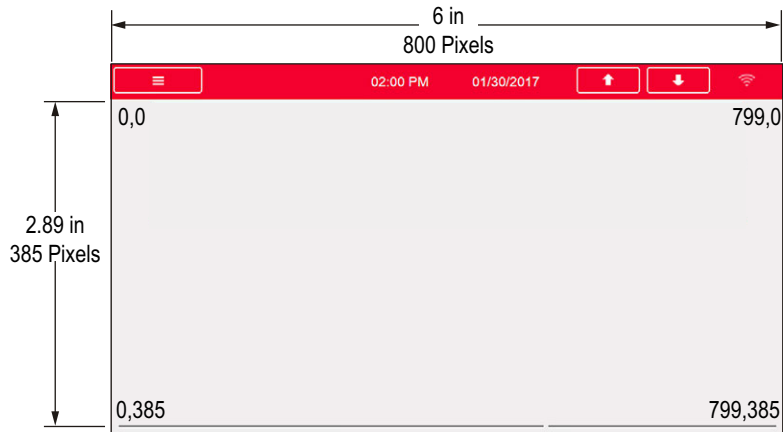

Figure 15-2. Screen Location Pixel Values - 7 Inch Display

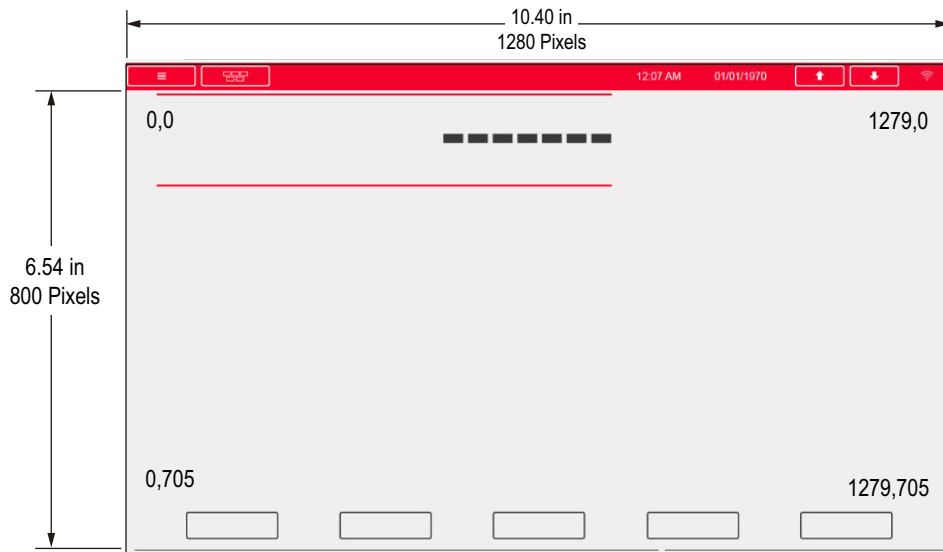

Figure 15-3. Screen Location Pixel Values - 12 Inch Display

### 15.2.1 Scale Widgets

Scale widgets are used to present basic scale data from one or more configured scales. To add a scale widget to the display, verify which screen is currently displayed, click on the Scale Widget icon on the left of the Display Editor and drag it to anywhere on the display.

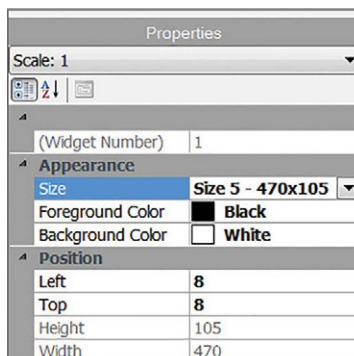

Figure 15-4. Scale Widgets

The following scale properties can be changed.

**Size** – seven size selections from small to large are available.

**Foreground Color** – this is the default text color. Foreground color can also be changed from iRite.

**Background Color** – this is the default background color. Background color can also be changed from iRite.

**Left/Top** – the number of pixels away from the left or top edge. Either drag and drop for approximate alignment, or enter a number for precise alignment.

## 15.2.2 Bitmap Widgets

Bitmap widgets provide a representation of vertical or horizontal tanks or a hopper. To add a bitmap widget to the display, verify which screen is currently displayed, click on the Bitmap Widget icon on the left of the Display Editor and drag it to anywhere on the display.

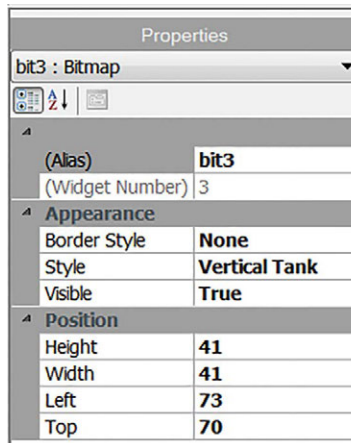

Figure 15-5. Bitmap Widgets

Bitmap properties which can be changed:

**Alias** – optional variable name to reference this widget from iRite.

**Border Style** – default is **None**, when enabled creates a thin black border around the bitmap.

**Style** – there are three choices, the vertical tank is default. Typically they are used with bar graphs placed overlaying them.



Figure 15-6. Bitmap Widget Style Options

**Visible** – defaults to True, if false the widget disappears. This can be changed from iRite.

**Height/Width** – height and width of the bitmap in pixels. This can be dragged/dropped (to resize the bitmap) or enter a number for either value.

**Left/Top** – position away from the left/top edge in pixels. This can be dragged/dropped (to reposition the bitmap) or enter a number for either value.



### 15.2.3 Bar Graph Widgets

Bar graph widgets allow display of vertical or horizontal graphs, either a normal bar graph style or a needle gauge, with or without graduations. The graph can be used to represent scale weight or progress toward a setpoint target value. To add a bar graph widget to the display, verify which screen is currently displayed, click on the **Bar graph Widget** icon on the left of the Display Editor and drag it to anywhere on the display.

Properties	
bar2 : Bar graph	
(Alias)	bar2
(Widget Number)	2
<b>Appearance</b>	
Border Style	None
Orientation	Dial
Color	Black
Visible	True
<b>Data Binding</b>	
Data Source	Scale
Data Field	Scale 1
Data Subfield	Gross
<b>Position</b>	
Height	77
Width	80
Left	503
Top	132

Figure 15-7. Bar Graph Widgets

Bar graph properties which can be changed:

**Alias** – optional variable name to reference this widget from iRite.

**Border Style** – when enabled, creates a thin black border around the bar graph, default is **None**.

**Orientation** – there are four choices, default is **Horizontal**.

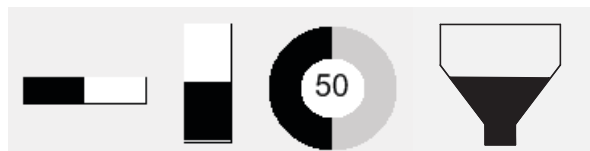

Figure 15-8. Bar Graph Widget Options

**Color** – color which fills the bar graph, this can be changed from iRite.

**Visible** – default is **True**, if set to false the widget disappears. This parameter can be changed from iRite.

**Data Source** – source of information which the bar graph is representing. Choices Include:

- Scale, meaning the bar graph is full at capacity (default)
- Programmability (percentage set from iRite)
- Setpoint (percentage based on how close to the setpoint tripping)

**Data Field** – works with the data source.

- If Data Source= Scale then the Data Field specifies the configured scale number
- If Data Source= Setpoint then the Data Field specifies the configured setpoint

**Data Subfield** – applies to a Data Source of Scale, the choices are Gross, Net or Displayed.

**Height/Width** – size of the bar graph in pixels (height and width). It can be dragged/dropped (to resize the bitmap) or a number can be entered for either of these values.

**Left/Top** – set distance from left/top edges in pixels. It can be dragged/dropped (to reposition the bar graph) or a number can be entered for either of these values.

## 15.2.4 Label Widgets

Label widgets are used to insert a text label in the display. To add a label widget to the display, verify which screen is currently displayed, click on the **Label Widget** icon on the left of the Display Editor and drag it to anywhere on the display.

Properties	
lbl1 : Label	
^	
(Alias)	lbl1
(Widget Number)	1
^ Appearance	
Border Style	Fixed Single
Caption	Caption
Justification	Left
Font	12
Color	Black
Visible	True
^ Data Binding	
Data Source	Scale
Data Field	Scale 1
Data Subfield	Gross Primary
^ Position	
Height	20
Width	76
Left	90
Top	237

Figure 15-9. Label Widgets

The following properties can be changed:

**Alias** – optional variable name to reference this widget from iRite.

**Border Style** – when enabled, creates a thin black border around the bar graph, default is **Fixed Single**.

**Caption** – this relates to the Data Source. If set to Self, the caption is the static text in the text box. Otherwise it is overwritten by whatever the Data Source is set to.

**Justification** – position of text in the text box, left, center or right.

**Font** – text size, default is 12.

**Color** – color of the text and border, it can be changed from iRite. The background cannot be changed.

**Visible** – default is **True**, if set to false the widget disappears. This parameter can be changed from iRite.

**Data Source** – the source of the information displayed in the widget. Choices include:

- Scale (weight is displayed)
- Programmability (text from iRite)
- Self (always displays the text from the Caption parameter)
- Setpoint (displays the setpoint prompt)

**Data Field** – available settings are dependent upon the Data Source. Only a Data Source of Scale or Setpoint requires a Data Field to be specified.

- If Data Source= Scale then the Data Field specifies the configured scale number
- If Data Source= Setpoint then the Data Field specifies the configured setpoint

**Data Subfield** – available settings are dependent upon the Data Source. Only a Data Source of Scale or Setpoint requires a Data Subfield to be specified.

- If Data Source= Scale then the Data Subfield specifies the weight data to be displayed
- If Data Source= Setpoint then the Data Subfield can be set to Setpoint Name, Setpoint Value, Preact Value or Tolerance Band Value

**Height/Width** – the height and width of the label widget in pixels. This can be dragged/dropped (to enlarge or shrink the widget) or for more precise sizes a number can be entered for any of these values.

**Left/Top** – set the distance from the left/top edges in pixels. This can be dragged/dropped (to position the label widget) or for more precise alignment a number can be entered for any of these values.

## 15.2.5 Symbol Widgets

Symbol widgets provide icons to indicate a variety of alarms, conditions or device states. To add a symbol widget to the display, verify which screen is currently displayed, click on the **Symbol Widget** icon on the left of the Display Editor and drag it to anywhere on the display.





Properties	
sym3 : Symbol	
   	
(Alias)	sym3
(Widget Number)	3
Appearance	
Style	Tare
Value	State 1
Color	Dark Grey
Visible	True
Data Binding	
Data Source	Scale
Data Field	Scale 1
Data Subfield	Tare
Position	
Left	124
Top	119
Height	32
Width	32

Figure 15-10. Symbol Widgets

The following properties can be changed:

**Alias** – optional variable name to reference this widget from iRite.

**Style** – defaulted to Tare. See [Table 15-2 on page 155](#).

**Value** – this relates the states, which varies in number depending on the style selected.

*Example: Tare has three states: Tare, Blank/invisible, or Pushbutton Tare.*

**Color** – color of the symbol; can be changed from iRite.

**Visible** – default is **True**, if false the widget disappears. This parameter can be changed from iRite.

**Data Source** – source of the data which causes symbol widgets to change states.

- Choices are Scale, Programmability (symbol state set by iRite), Setpoint or Digital I/O

**Data Field** – available settings are dependent upon the Data Source.

- If Data Source= Scale then the Data Field specifies the configured scale number
- If Data Source= Digital I/O then the Data Field specifies the slot number of the Digital I/O interface
- If Data Source= Setpoint then the Data Field specifies the configured setpoint

**Data Subfield** – available settings are dependent upon the Data Source. Only a Data Source of Scale or Digital I/O require a Data Subfield to be specified.

- If Data Source= Scale then the Data Subfield specifies the scale condition which is to change the widget's state
- If Data Source= Digital I/O then the Data Field specifies the bit number of the digital I/O interface

**Left/Top** – set the distance from the left/top edges in pixels. Can be dragged/dropped (to reposition the label widget) or a number can be entered for any of these values.

## 15.2.6 Image Widgets

Image Widgets are used to insert images in the display. Images can be stored locally on a micro SD card, or externally at a specific URL address. Supported image formats are .jpeg/.jpg, .gif, .png, and .svg.



**NOTE: Animated .gif files are not supported.**

To add an image widget to the display, verify which screen is currently displayed, click on the **Symbol Widget** icon on the left of the Display Editor and drag it to anywhere on the display.

Properties	
img4 : Image	
^	
(Alias)	img4
(Widget Number)	4
^ Appearance	
Filename/Url	
RefreshTime	0
Border Style	None
Visible	True
^ Position	
Height	100
Width	100
Left	288
Top	114

Figure 15-11. Image Widgets

Image properties which can be changed:

**Alias** – optional variable name to reference this widget from iRite.

**Filename/URL** – specifies the file path or URL address of the image. If using a micro SD card, create a folder in the root folder of the micro SD card called *SDimages*. Place the image into the folder and enter the image file name (including extension) into the Path/URL field. Multiple images with different file names can be used in the same *SDimages* folder. If using an image located at a URL Address, enter the address here. The 1280 has to be connected to a network which can access the specified URL Address.

**Refresh Time** – the interval (in seconds) the image is refreshed from the location specified above.

**Border Style** – when enabled, creates a thin black border around the bar graph, default is **None**.

**Visible** – defaults to True, if false the widget disappears. This can be changed from iRite.

**Height/Width** – height and width of the bitmap in pixels. This can be dragged/dropped (to resize the image) or enter a number for either value.

**Left/Top** – position away from the left/top edge in pixels. This can be dragged/dropped (to reposition the image) or enter a number for either value.

### Internal Stock Images

To access internal stock images, utilize **local://** to specify a local file. Examples of internal stock images are provided in [Table 15-1](#).

































Image	Description	Filename	Image	Description	Filename
	Auxiliary Print	1.png		Page Down	18.png
	Gross Net	2.png		Page Up	19.png
	Keyed Tare	3.png		Reports	20.png
	Print	4.png		Start	21.png
	Screen Selection	5.png		Go Button Night View	22.png
	Tare	6.png		Go Button Day View	23.png
	Units	7.png		Stop Button Night View	24.png
	Exit Box	9.png		Stop Button Day View	25.png
	More	10.png		Stop	26.png
	Setup	11.png		Print	27.png
	Exit	12.png		Paper	28.png
	Delete All	13.png		Red Bar	29.png
	Delete Entry	14.png		Dark Green Bar	30.png
	Truck Database Search	15.png		Grey Bar	31.png
	Off	16.png		Green Bar	32.png
	On	17.png		Dark Red Bar	33.png

Table 15-1. Stock Images



































Image	Description	Filename	Image	Description	Filename
	Light Grey Bar	34.png		Print	52.png
	Yellow Bar	35.png		Rail Car	53.png
	No	36.png		Rail Boss Logo	54.png
	Yes	37.png		Rail Boss Background	55.png
		38.png		Logo	56.png
		39.png		Full Draft	57.png
		40.png		Double Draft	58.png
		41.png		1 Scale	59.png
	Red Light	42.png		2 Scale_1	60.png
	Green Light	43.png		2 Scale_1_2	61.png
	Blue	44.png		2 Scale_2	62.png
	Green	45.png		3 Scale_1	63.png
	Gray	46.png		3 Scale_1_2	64.png
	Red	47.png		3 Scale_1_3	65.png
	Dark Red	48.png		3 Scale_2	66.png
	Clear Total	49.png		3 Scale_2_3	67.png
	Discharge	50.png		3 Scale_3	68.png
	Print Total	51.png			

Table 15-1. Stock Images (Continued)

## 15.2.7 Chart Widgets

Chart widgets are used to visually graph data on the 1280 display. Available chart types include line graphs, vertical bar charts, and horizontal bar charts. These features can only be used in conjunction with an iRite program to populate these charts. See the iRite manual (PN 67888).

To add a chart widget to the display, verify which screen is currently displayed, click in the **Chart Widget** icon on the left of the Display Editor and drag it to anywhere on the display.

Properties	
cht5 : Chart	
<input type="checkbox"/> <input type="checkbox"/> <input type="checkbox"/> <input type="checkbox"/> <input type="checkbox"/>	
^	
(Alias)	cht5
(Widget Number)	5
^ Appearance	
Visible	True
Style	Line Chart
^ Position	
Height	100
Width	100
Left	180
Top	106

Figure 15-12. Chart Widgets

Chart properties which can be changed from Revolution:

**Alias** – optional variable name to reference this widget from iRite.

**Visible** – default is **True**, if false the widget disappears. This parameter can be changed from iRite.

**Style** – select the chart style (**Line Chart** or **Bar Chart**).

**Height/Width** – height and width of the chart area in pixels. This can be dragged/dropped (to resize the chart widget) or enter a number for either value.

**Left/Top** – position away from the left/top edge in pixels. This can be dragged/dropped (to reposition the chart widget) or enter a number for either value.

## 15.2.8 Line Widgets

Lines can be used as separators for the other widgets on the screen.

Properties	
line1 : Line	
^	
(Alias)	line1
(Widget Number)	1
^	
<b>Appearance</b>	
Orientation	Horizontal
Color	Black
Visible	True
^	
<b>Misc</b>	
Type	LineWidget
WidgetCommand	10,317,170,80,1,1,1,6
^	
<b>Position</b>	
Height	1
Width	80
Left	317
Top	170

Figure 15-13. Line Widget Properties

**Alias** – optional variable name to reference this widget from iRite.

**Orientation** – select horizontal or vertical lines.

**Color** – color of the line; can be changed from iRite.

**Visible** – default is **True**, if false the widget disappears. This parameter can be changed from iRite.

**Height/Width** – height and width of the chart area in pixels. This can be dragged/dropped (to resize the chart widget) or enter a number for either value.

**Left/Top** – position away from the left/top edge in pixels. This can be dragged/dropped (to reposition the chart widget) or enter a number for either value.



## 15.2.9 Softkey Widgets

Softkey widgets provide buttons which can be set with softkey commands, see [Section 6.1 on page 82](#). To add a softkey widget to the display, verify which screen is currently displayed, click on the **Symbol Widget** icon on the left of the Display Editor and drag it to anywhere on the display.

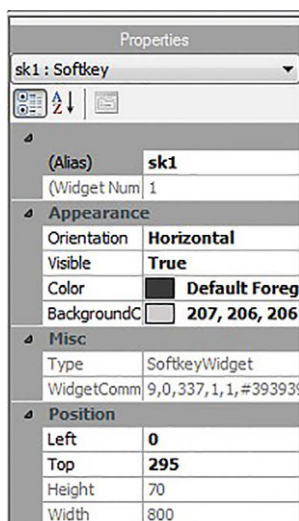

Figure 15-14. Softkey Widget Properties

**Alias** – optional variable name to reference this widget from iRite.

**Orientation** – select horizontal or vertical.

**Visible** – default is **True**, if false the widget disappears. This parameter can be changed from iRite.

**Color** – color of the softkey text and border can be changed but only if the actual softkey widget is used.

**Background Color** – Background color of the softkey can also be changed but only if the actual softkey widget is used.

**Height/Width** – read only.

**Left/Top** – position away from the left/top edge in pixels. This can be dragged/dropped (to reposition the chart widget) or enter a number for either value.

Default Softkeys can be reincorporated automatically by entering the **Features** menu, under **General** and select **Softkey Auto-Population**.

This conflicts with softkey widgets added in Revolution.

## 15.3 Widget Colors

When defining the display widgets, the color of some of their elements can be specified. This ability varies by widget type.

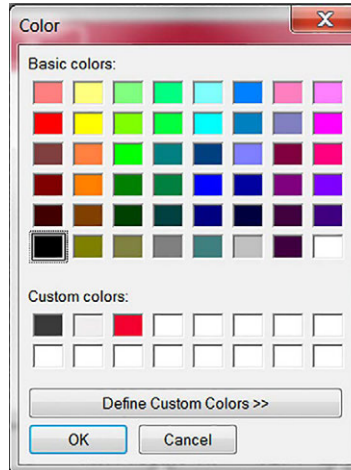

Figure 15-15. Widget Colors

**Scale Widgets** – the color of both the foreground and background can be specified.

**Bar Graph** – only a foreground color can be specified.

**Label Widgets** – only a foreground color can be specified.

**Symbol Widgets** – one of 16 fixed colors can be selected.

**Bitmap Widgets** – cannot be colored, they are only a black outline with a clear background.

**Chart Widgets** – color changes can only be done with the iRite programming.

**Line Widgets** – color changes can only be done with the iRite programming.

**Softkey Widgets** – only text and border can be changed with the iRite programming.

There are three custom colors which are available. These are used for the indicator display.

	Description	Widget State 1	Widget State 2	Widget State 3	Widget State 4
1	Tare				
2	Standstill				
3	Center of Zero				
4	Round Indicator				
5	Square Indicator				
6	Bell				
7	Exclamation Symbol				
8	Light Bulb				
9	Divert Product				
10	Over / Under/In Range				
11	Stoplight				
12	Left Arrow				
13	Right Arrow				
14	Up Arrow				
15	Down Arrow				
16	Speaker				
17	Serial Status				
18	Truck On Scale 1				
19	Truck On Scale 2				
20	Weight On Scale				
21	Overload				
22	Underload				
23	Stop Sign				
24	Yield Sign				
25	Skull & Crossbones				
26	Unbalanced				
27	Runner				
28	Walker				
29	Printer				

Table 15-2. Widget Table





























	Description	Widget State 1	Widget State 2	Widget State 3	Widget State 4
30	Hourglass				
31	Gas Pump				
32	Conveyor				
33	Batch Auto/Manual				
34	Valve				
35	Motor				
36	Checkmark				
37	Faucet				
38	Padlock				
39	Key				
40	Pipe				
41	Not				
42	Conveyor Full				
43	Info				
44	Power				
45	Folder				
46	Recipe				
47	Report				
48	Manual Mode	<b>M</b>			

Table 15-2. Widget Table (Continued)

## 16.0 EDP Commands

The EDP command set is divided into several groups as provided in this section. 1189

The 1280 indicator can be controlled by a computer connected to one of the indicator communication ports. Control is provided by a set of commands which can simulate front panel key press functions, return and change setup parameters, and perform reporting functions. The commands provide the capability to print configuration data or to save the data to an attached computer. This section describes the EDP command set and procedures for saving and transferring data using the communication ports.

When the indicator processes a command, it either responds with a value (for reporting commands, or when querying parameter settings), or with the message **OK**. The **OK** response verifies the command was received and has been executed. If the command is unrecognized or cannot be executed, the indicator responds with **??**.

### 16.1 Key Press Commands

Key press serial commands simulate pressing the keys on the front panel of the indicator. These commands can be used in both setup and weigh mode. Several of the commands serve as pseudo keys, providing functions which are not represented by a key on the front panel. For example, to enter a 15 lb tare weight using serial commands:

1. Type **K1** and press **Enter** (or **Return**).
2. Type **K5** and press **Enter**.
3. Type **KTARE** and press **Enter**.

Command	Function
KSCALESELECT	Selects scale number <i>Example: to select scale number 2, type K2 and press <b>Enter</b> then type KSCALESELECT and press <b>Enter</b>.</i>
KZERO	In weighing mode, this command acts like pressing the <b>Zero</b> key
KGROSSNET	In weighing mode, this command acts like pressing the <b>Gross/Net</b> key
KGROSS	Sets currently selected scale to display Gross mode
KNET	Sets currently selected scale to display Net mode
KTARE	In weighing mode, this command acts like pressing the <b>Tare</b> key
KUNITS	In weighing mode, this command acts like pressing the <b>Units</b> key
KPRIM	Sets currently selected scale to display primary units
KSEC	Sets currently selected scale to display secondary units
KTER	Sets currently selected scale to display tertiary units
KPRINT	In weighing mode, this command acts like pressing the <b>Print</b> key
KDISPACCUM	Displays the accumulator value of the currently selected scale; Only prints to 7 digits
KDISPTARE	Displays the tare value of the currently selected scale
KCLR	In weighing mode, this command acts like pressing the <b>Clear</b> key; this clears the last character entered, or can be used to clear the accumulator or tare value of the currently selected scale while either is displayed
KCLRCN	Resets consecutive number
KCLRTAR	Clears the tare from the currently selected scale
KLEFT	This command acts like pressing the <b>Left Arrow</b> key
KRIGHT	This command acts like pressing the <b>Right Arrow</b> key
KUP	This command acts like pressing the <b>Up Arrow</b> key
KDOWN	This command acts like pressing the <b>Down Arrow</b> key
KSAVEEXIT	This command acts like pressing the <b>Save and Exit</b> key; this saves the current configuration and returns to weigh mode
Kn	This command acts like pressing numbers 0–9
KDOT	This command acts like pressing the decimal point (.)
KENTER	This command acts like pressing the <b>Enter</b> key
KSOFT:x	This command acts like pressing the softkey number <b>x</b>
KLOCK	Lock specified front panel key <i>Example: to lock the <b>Zero</b> key, enter KLOCK=KZERO.</i>

Table 16-1. Key Press Commands

Command	Function
KUNLOCK	Unlock specified front panel key <i>Example: to unlock the <b>Print</b> key, enter KUNLOCK=KPRINT.</i>
KCOMMIT	After changes are made to configuration parameters using EDP commands, use this command to commit the changes to memory before leaving configuration mode
KSETPOINT	Display setpoint configuration
KDATE	Display date
KTIME	Display time
KTIMEDATE	Display time and date

Table 16-1. Key Press Commands (Continued)

## 16.2 Reporting Commands

Reporting commands send specific information to the communications port. The commands listed in Table 16-2 can be used in either setup mode or weigh mode.

Command	Function
DUMPALL	Returns a list of all parameter values
SPDUMP	Returns a list of only the setpoint parameter values
VERSION	Returns the core firmware version number
HARDWARE	Returns a list of option cards installed in slots 1–6; See Section 13.1 on page 124 for more information about using the HARDWARE command
HWSUPPORT	Returns the CPU board part number
OPTVERSION#s	Returns the Firmware version of the option card installed in slot s
OPTHWVERSION#s	Returns the Hardware version of the option card installed in slot s
DUMPAUDIT	Returns the Audit Trail information
DUMPVERSIONS	Returns the versions of all files, software and installed option cards
TSPRINT.START	Starts record of touch screen touch coordinates; Recording runs for 30 seconds or until TSPRINT.STOP is entered
TSPRINT.START_RAW	Starts record of touch screen touch raw data; Recording runs for 30 seconds or until TSPRINT.STOP is entered
TSPRINT.STOP	Manually stops recording of touch screen touch coordinates or data
TSPRINT.VIEW	Returns record of touch screen coordinates or data

Table 16-2. Reporting Commands

## 16.3 Clear and Reset Commands

The following commands can be used to clear and reset the 1280:

Command	Function
PCLR	Program Clear – erases the loaded user program (setup mode only)
RS	Reset System – reboots the indicator without resetting the configuration
RESETCONFIGURATION	Reset Configuration – restores all configuration parameters to default values (setup mode only)
PARTIALRESETCONFIGURATION	Reset all settings except for Scales and Network settings (setup mode only)
REMOVE.TSCAL	Clears the touchscreen calibration on the next power cycle

Table 16-3. Clear/Reset Commands



**NOTE:** All scale calibration, iRite and database settings are lost when the RESETCONFIGURATION command is run.

## 16.4 Parameter Setting Commands

Parameter setting commands allow the current value for a configuration parameter to be displayed or changed.

Current configuration parameter settings can be displayed in configuration mode or weigh mode using the following syntax:

```
command<ENTER>
```

Most parameter values can be changed in setup mode only; setpoint parameters listed in [Table 16-11 on page 167](#) can be changed when in normal weighing mode.



**NOTE:** The user must stop the current batch for new values to take effect.

Use the following command syntax when changing parameter values: `command=value<ENTER>`, where **value** is either a number or a parameter value. Use no spaces before or after the equal (=) sign. If an incorrect command is typed or an invalid value is specified, the indicator returns `??`.

*Example: to set the motion band parameter on Scale #1 to 5 divisions, type the following:*

```
SC.MOTBAND#1=5<ENTER>
```

To return a list of the available values for parameters with specific values, enter the command and equal sign, followed by a question mark (`command=?<ENTER>`). The indicator must be in setup mode to use this function.

After changes are made to configuration parameters using EDP commands, use the **KCOMMIT** command to commit the changes to memory prior to using the **KSAVEEXIT** command or pressing .

### 16.4.1 Scales Commands

Command	Description	Values
SC.CAPACITY#n	Scale capacity	0.000001–9999999
SC.SPLIT#n	Multi-range or multi-interval scale type	OFF, MULTIRANGE, MULTIINTERVAL
SC.ZTRKBND#n	Zero track band	0.0–100 (in display divisions)
SC.ZRANGE#n	Zero range	0–10000 (in 0.01% intervals - 100=1%)
SC.MOTBAND#n	Motion band	0–100 (in display divisions)
SC.SSTIME#n	Standstill time	1–600 (in 0.1 second intervals)
SC.OVERLOAD#n	Overload	FS+2%, FS+1D, FS+9D, FS
SC.WMTTHR#n	Weighment threshold	0.0–9999999
SC.DIA.ZREF	Zero Reference	ON, OFF
SC.DIA.ZREF.RANG	Zero Range	-100.0–100.0 (real)
SC.DIA.ZREF.THRESH	Zero Threshold	-100.0–100.0 (real)
SC.DIA.ZREF.TIME	Zero Time	1–60 (integer)
SC.DIA.DRIFT	Scale Drift	ON, OFF
SC.DIA.DRIFT.RANGE	Drift Range	-100.0–100.0 (real)
SC.DIA.DRIFT.THRESH	Drift Threshold	-100.0–100.0 (real)
SC.DIA.DRIFT.TIME	Drift Time	1–300 (integer)
SC.DIA.NOISE	Noise	ON, OFF
SC.DIA.NOISE.THRESH	Noise Threshold	0.0–100.0 (real)
SC.DIA.NOISE.TIME	Noise Time	1–300 (integer)
SC.DIA.UNBAL	Unbalance	ON, OFF
SC.DIA.UNBAL.RANGE	Unbalance Range	-100.0–100.0 (real)
SC.DIA.UNBAL.THRESH	Unbalance Threshold	-100.0–100.0 (real)
SC.DIGFLTR1#n SC.DIGFLTR2#n SC.DIGFLTR3#n	Number of A/D samples averaged for the individual stages (1–3) of the three stage digital filter	1, 2, 4, 8, 16, 32, 64, 128, 256
SC.DFSENS#n	Number of consecutive A/D readings outside the threshold setting before the three stage digital filter cuts out	2OUT, 4OUT, 8OUT, 16OUT, 32OUT, 64OUT, 128OUT
SC.DFTHR#n	Three stage digital filter cutout threshold in display divisions	NONE, 2D, 5D, 10D, 20D, 50D, 100D, 200D, 250D

Table 16-4. Scales Commands

Command	Description	Values
SC.RATLTRAP#n	Enable the special Rattletrap filtering mode for the three stage digital filter	OFF, ON
SC.SMPRAT#n	Scale A/D sample rate	6.25HZ, 7.5HZ, 12.5HZ, 15HZ, 25HZ, 30HZ, 50HZ, 60HZ, 100HZ, 120HZ, 200HZ, 240HZ, 400HZ, 480HZ, 800HZ, 960HZ
SC.PWRUPMD#n	Power up mode	GO, DELAY
SC.TAREFN#n	Tare function	BOTH, NOTARE, PBTARE, KEYED
SC.PRI.FMT#n	Primary units format (decimal point and display divisions)	8888100, 8888200, 8888500, 8888810, 8888820, 8888850, 8888881, 8888882, 8888885, 888888.1, 888888.2, 888888.5, 888888.81, 888888.82, 888888.85, 8888.881, 8888.882, 8888.885, 888.8881, 888.8882, 888.8885, 88.88881, 88.88882, 88.88885, 8.888881, 8.888882, 8.888885
SC.PRI.UNITS#n	Primary units	LB, KG, G, OZ, TN, T, GR, TROYOZ, TROYLB, LT, CUSTOM1, CUSTOM2, CUSTOM3, MV, MA, V,F, C, K, R
SC.SEC.FMT#n	Secondary units format (decimal point and display divisions)	8888100, 8888200, 8888500, 8888810, 8888820, 8888850, 8888881, 8888882, 8888885, 888888.1, 888888.2, 888888.5, 888888.81, 888888.82, 888888.85, 8888.881, 8888.882, 8888.885, 888.8881, 888.8882, 888.8885, 88.88881, 88.88882, 88.88885, 8.888881, 8.888882, 8.888885
SC.SEC.UNITS#n	Secondary units	LB, KG, G, OZ, TN, T, GR, TROYOZ, TROYLB, LT, CUSTOM1, CUSTOM2, CUSTOM3, MV, MA, V,F, C, K, R
SC.SEC.MULT#n	Secondary units multiplier	0.000001–9999999.9
SC.TER.UNITS#n	Tertiary units	LB, KG, G, OZ, TN, T, GR, TROYOZ, TROYLB, LT, CUSTOM1, CUSTOM2, CUSTOM3, MV, MA, V,F, C, K, R
SC.TER.FMT#n	Tertiary units format (decimal point and display divisions)	8888100, 8888200, 8888500, 8888810, 8888820, 8888850, 8888881, 8888882, 8888885, 888888.1, 888888.2, 888888.5, 888888.81, 888888.82, 888888.85, 8888.881, 8888.882, 8888.885, 888.8881, 888.8882, 888.8885, 88.88881, 88.88882, 88.88885, 8.888881, 8.888882, 8.888885
SC.TER.MULT#n	Tertiary units multiplier	0.000001–9999999.9
SC.ROC.FMT#n	Rate-of-Change format (decimal point and display divisions)	8888100, 8888200, 8888500, 8888810, 8888820, 8888850, 8888881, 8888882, 8888885, 888888.1, 888888.2, 888888.5, 888888.81, 888888.82, 888888.85, 8888.881, 8888.882, 8888.885, 888.8881, 888.8882, 888.8885, 88.88881, 88.88882, 88.88885, 8.888881, 8.888882, 8.888885
SC.ROC.MULT#n	Rate-of-change units multiplier	0.000001–1000000
SC.ROC.UNITS#n	Rate-of-change units	SEC, HOUR, MIN, DAY
SC.ROC.INTERVL#n	Rate-of-change interval	0.0–180000 (in 0.1 second intervals)
SC.RANGE1#n	Weight maximum for first range or interval	0.0–9999999
SC.RANGE2#n	Weight maximum for second range or interval	0–9999999
SC.ACCUM#n	Accumulator enable	OFF, ON
SC.VISIBLE#n	Scale visibility	OFF, ON
SC.PEAKHOLD#n	Peak hold	OFF, NORMAL, BI-DIR, AUTO
SC.WZERO#n	Perform zero (dead-load) calibration	--
SC.WVAL#n	Test weight value	0.000001–1000000
SC.WSPAN#n	Perform span calibration	--
SC.WLIN.F1#n– SC.WLIN.F4#n	Actual raw count value for linearization points 1–4	0–16777215

Table 16-4. Scales Commands (Continued)



Command	Description	Values
SC.WLIN.V1#n– SC.WLIN.V4#n	Test weight value for linearization points 1–4	0.0–9999999 (a setting of 0 indicates the linearization point is not used)
SC.WLIN.C1#n– SC.WLIN.C4#n	Perform linearization calibration on points 1–4	--
SC.LC.CD#n	Zero (dead-load) raw count value	0–16777215
SC.LC.CW#n	Span raw count value	0–16777215
SC.LC.CZ#n	Temporary zero raw count value	0–16777215
SC.REZERO#n	Perform the Rezero calibration function	--
SC.SLOT#n	The physical slot the scale card is installed in	1–6
SC.CHANNEL#n	The channel on the scale card assigned to the scale	1–2
SC.SOURCECALES#n	Defines the scales assigned to the total scale n	Comma-delimited string of scale numbers
SC.CUNITS1#n	Defines the name for custom units 1	Up to 8 alphanumeric characters
SC.CUNITS2#n	Defines the name for custom units 2	Up to 8 alphanumeric characters
SC.CUNITS3#n	Defines the name for custom units 3	Up to 8 alphanumeric characters
SC.INITIALZERO#n	The Initial Zero range in % of full scale	0–100
SC.KIND#n	Defines the type of scale	NONE, ANALOG, TOTAL, ANALOG-INPUT, LFT-SERIAL, IND-SERIAL, PROGRAM
SC.ALGINTYPE#n	Defines the type of input for an analog input option card	±10 V, ±100 MV, AMBIENT CURRENT, J, K, T, E, N
SC.ALIAS#n	Defines a name for the scale	Up to 8 alphanumeric characters
SC.COMM#n	Serial Input Scale Types – tells indicator which communications port the serial input data is received on	Up to 8 alphanumeric characters; the value must be a valid name of one of the communications ports
SC.INFORMAT#n	Serial Input Scale types – tells the indicator which of the four Stream Formats defines the format of the Serial Input Data	1–4
SC.CALSTART.t#n	Used to start a serial command calibration sequence	t = Type: 1=Normal, 2=Last Zero, 3=Temp Zero, 4=Theoretical, 5=Section Match, 6=Corner Match
SC.CALEND#n	Used to finish a serial command calibration sequence	--
SC.FILTERCHAIN#n	Defines what filter to use	RAW, ADAPTIVEONLY, AVERAGEONLY
SC.DAMPINGVALUE#n	Sets the damping time constant	0–2560 (in 0.1 second intervals)
SC.ABTHRESHHOLD#n	Adaptive Filter weight threshold value	0–2000 (in display divisions)
SC.ABSENSITIVITY#n	Adaptive Filter sensitivity	LIGHT, MEDIUM, HEAVY
SC.MIN.WEIGHT#n	Minimum weighment setting	0.0–9999.9
SC.SMPRAT.10V#n	Sample rate of an Analog Input option card	10HZ, 50HZ, 60HZ, 250HZ
SC.PRI.ENABLED#n	Enable the Primary Units	OFF, ON
SC.SEC.ENABLED#n	Enable the Secondary Units	OFF, ON
SC.TER.ENABLED#n	Enable the Tertiary Units	OFF, ON
SC.RANGE1.FMT#n	Multi-Interval/Range range 1 format – decimal point and display divisions	8888100, 8888200, 8888500, 8888810, 8888820, 8888850, 8888881, 8888882, 8888885, 888888.1, 888888.2, 888888.5, 88888.81, 88888.82, 88888.85, 8888.881, 8888.882, 8888.885, 888.8881, 888.8882, 888.8885, 88.88881, 88.88882, 88.88885, 8.888881, 8.888882, 8.888885
SC.RANGE2.FMT#n	Multi-Interval/Range range 2 format – decimal point and display divisions	8888100, 8888200, 8888500, 8888810, 8888820, 8888850, 8888881, 8888882, 8888885, 888888.1, 888888.2, 888888.5, 88888.81, 88888.82, 88888.85, 8888.881, 8888.882, 8888.885, 888.8881, 888.8882, 888.8885, 88.88881, 88.88882, 88.88885, 8.888881, 8.888882, 8.888885
SC.MAX_DATE#n	Returns date and time of the maximum weighment	--
SC.MAX_WEIGHT#n	Returns the value of the maximum weighment	--

Table 16-4. Scales Commands (Continued)

Command	Description	Values
SC.NUMWEIGH#1	Returns the number of weighments which exceed the minimum weighment value	--
SC.TOTAL.DP.MATCH.SOURCE	Match Total Scale decimal to source scales	OFF, ON
SC.TOTAL.SUM.INTERNAL.RESOLUTION	When set to <b>Off</b> , Total Scale sums the adjusted displayed weights of the source scales; When set to On, Total scale sums the unadjusted weight of the source scales and applies the internal resolution (Decimal Position and Display Divisions) that is set in the Total Scale parameters	OFF, ON

For commands ending with #n, n is the scale number (1–8)

Table 16-4. Scales Commands (Continued)

## 16.4.2 Communication Commands

Command	Description	Values
EDP.INPUT#p	Port serial input function	PROGIN, CMD, SCALE, IND SC, IQUBE2, DIGITALLOADCELL, UNKNOWN
EDP.BAUD#p	Port baud rate	300, 600, 1200, 2400, 4800, 9600, 19200, 38400, 57600, 115200
EDP.BITS#p	Port data bits/parity	8NONE, 7EVEN, 7ODD, 8ODD, 8EVEN
EDP.TERMIN#p	Port line termination character	CR/LF, CR, ETX, EOT, FF
EDP.STOPBITS#p	Port stop bits	1, 2
EDP.ECHO#p	Port echo	OFF, ON
EDP.RESPONSE#p	Port response	OFF, ON
EDP.EOLDLY#p	Port end-of-line delay	0-255 (0.1-second intervals)
EDP.HANDSHK#p	Port handshaking	OFF, XONXOFF, HRDWAR
EDP.TYPE#p	Port type	232, 485, 422
EDP.DUPLEX#p	Port RS-485/RS-422 duplex	HALF, FULL
EDP.ADDRESS#p	Port RS-485 address	0-255
EDP.ALIAS#p	Defines a name for the port	Up to 8 alphanumeric characters

For commands including #p, p is the port number (1–16)

Table 16-5. Serial Port Commands

Command	Description	Values
WIRED.MACID	Ethernet hardware MAC ID (read only)	xx:xx:xx:xx:xx:xx
WIRED.DHCP	Enable Ethernet DHCP	ON, OFF
WIRED.ENABLED	Enable Wired Ethernet Adapter	ON, OFF
WIRED.IPADDR	Ethernet IP Address	Valid IP xxx.xxx.xxx.xxx*
WIRED.SUBNET	Ethernet Subnet Mask	Valid IP xxx.xxx.xxx.xxx*
WIRED.GATEWAY	Ethernet Gateway	Valid IP xxx.xxx.xxx.xxx*
WIRED.PRIDNS	Ethernet Primary DNS	Valid IP xxx.xxx.xxx.xxx*
WIRED.SECDNS	Ethernet Secondary DNS	Valid IP xxx.xxx.xxx.xxx*
WIFI.MACID	Wi-Fi Hardware MAC ID (read only)	xx:xx:xx:xx:xx:xx
WIFI.DHCP	Enable Wi-Fi DHCP	OFF, ON
WIFI.ENABLED	Enable Wi-Fi Ethernet Adapter	ON, OFF
WIFI.IPADDR	Wi-Fi IP Address	Valid IP xxx.xxx.xxx.xxx*
WIFI.SUBNET	Wi-Fi Subnet Mask	Valid IP xxx.xxx.xxx.xxx*
WIFI.GATEWAY	Wi-Fi Gateway	Valid IP xxx.xxx.xxx.xxx*
WIFI.PRIDNS	Wi-Fi Primary DNS	Valid IP xxx.xxx.xxx.xxx*
WIFI.SECDNS	Wi-Fi Secondary DNS	Valid IP xxx.xxx.xxx.xxx*
WIFI.NETWORK	Wi-Fi Network Type	INFRASTRUCTURE
WIFI.SSID	Wi-Fi SSID	Up to 32 alphanumeric characters

Table 16-6. Ethernet TCP/IP and Wi-Fi Commands

Command	Description	Values
WIFI.SECURITY	Wi-Fi Security Type	OPEN, SHARED, WPA, WPA2
WIFI.ENCRYPTION	Wi-Fi Encryption Type	TKIP, AES
WIFI.CRYPTO_KEY	Wi-Fi Encryption Key	Up to 15 alphanumeric characters
DIRECT.ENABLED	Enable Wi-Fi Direct	ON, OFF
TCPC1.ECHO	TCP Client 1 Echo	OFF, ON
TCPC1.EOLDLY	TCP Client 1 End-of-line Delay	0–255 (in 0.1 sec intervals)
TCPC1.IPADDR	TCP Client 1 Remote Server IP	Valid IP xxx.xxx.xxx.xxx*
TCPC1.LINETERM	TCP Client 1 Line Termination	CR/LF, CR, ETX, EOT, FF
TCPC1.NAME	TCP Client 1 Name	Up to 16 alphanumeric characters
TCPC1.PORT	TCP Client 1 Remote Server Port	1025–65535
TCPC1.RESPONSE	TCP Client 1 Response	OFF, ON
TCPC2.ECHO	TCP Client 2 Echo	OFF, ON
TCPC2.EOLDLY	TCP Client 2 End-of-line Delay	0–255 (in 0.1 sec intervals)
TCPC2.IPADDR	TCP Client 2 Remote Server IP	Valid IP xxx.xxx.xxx.xxx*
TCPC2.LINETERM	TCP Client 2 Line Termination	CR/LF, CR, ETX, EOT, FF
TCPC2.NAME	TCP Client 2 Name	Up to 16 alphanumeric characters
TCPC2.PORT	TCP Client 2 Remote Server Port	1025–65535
TCPC2.RESPONSE	TCP Client 2 Response	OFF, ON
TCPC3.ECHO	TCP Client 3 Echo	OFF, ON
TCPC3.EOLDLY	TCP Client 3 End-of-line Delay	0–255 (in 0.1 sec intervals)
TCPC3.IPADDR	TCP Client 3 Remote Server IP	Valid IP xxx.xxx.xxx.xxx*
TCPC3.LINETERM	TCP Client 3 Line Termination	CR/LF, CR, ETX, EOT, FF
TCPC3.NAME	TCP Client 3 Name	Up to 16 alphanumeric characters
TCPC3.PORT	TCP Client 3 Remote Server Port	1025–65535
TCPC3.RESPONSE	TCP Client 3 Response	OFF, ON
TCPS.ENABLED	TCP Server Enabled	ON, OFF
TCPS.ECHO	TCP Server Echo	OFF, ON
TCPS.INPUT	TCP Server Input Type	CMD
TCPS.LINETERM	TCP Server Line Termination	CR/LF, CR, ETX, EOT, FF
TCPS.NAME	TCP Server Name	Up to 16 alphanumeric characters
TCPS.PORT	TCP Server Port Number	1025–65535
TCPS.RESPONSE	TCP Server Response	OFF, ON
UDPS.LINETERM	UDP Server Line Termination	CR/LF, CR, ETX, EOT, FF
UDPS.NAME	UDP Server Name	Up to 16 alphanumeric characters
UDPS.PORT	UDP Server Port Number	1025–65535
TCPC1.DISCTIME	TCP Client 1 Disconnect Time (in seconds)	0-60 (0= do not disconnect)
TCPC2.DISCTIME	TCP Client 2 Disconnect Time (in seconds)	0-60 (0= do not disconnect)
TCPC3.DISCTIME	TCP Client 3 Disconnect Time (in seconds)	0-60 (0= do not disconnect)
TCPC1.INPUT	TCP Client 1 Input Function	CMD, PROGIN, SCALE, INDSC, IQUBE2
TCPC2.INPUT	TCP Client 2 Input Function	CMD, PROGIN, SCALE, INDSC, IQUBE2
TCPC3.INPUT	TCP Client 3 Input Function	CMD, PROGIN, SCALE, INDSC, IQUBE2

\* A valid IP consists of four numbers, in the range of 0 to 255, separated by a decimal point  
Example – 127.0.0.1 and 192.165.0.230 are valid IP addresses.

Table 16-6. Ethernet TCP/IP and Wi-Fi Commands (Continued)

Command	Description	Values
EMAIL.ACCOUNT_NAME	Name of the account used for email	Alphanumeric string
EMAIL.DEFAULT_FROMADDRESS	Default "from" address used for emails	Alphanumeric string
EMAIL.DEFAULT_SUBJECT	Default "subject" used for emails	Alphanumeric string
EMAIL.DEFAULT_TOADDRESS	Default "to" address used for emails	Alphanumeric string
EMAIL.ENABLE_NOTIFICATION	Enables email notifications	Alphanumeric string
EMAIL.ENABLE_SSL	Enables secure protocols for emails	ON, OFF
EMAIL.SERVER_ADDRESS	Server address to use for emails	Alphanumeric string
EMAIL.SERVER_PORT	Server port to use for emails	Numeric String
EMAIL.ACCOUNT_PASSWORD	Account password to use for emails	Alphanumeric string

Table 16-7. Email Commands

Command	Description	Values
STRM.FORMAT#n	Stream format	RLWS, CARDINAL, WEIGHTRONIX, TOLEDO, CUSTOM
STRM.CUSTOM#n	Custom stream definition	Up to 200 alphanumeric characters
STRM.DESTINATION#n	Stream destination port	A comma delimited list of communications ports; values: NONE, PORT1 - PORT16, TCPC1, TCPC2, and UDPS Example - to stream format 1 to ports 1, 3, and TCPC2: "STRM.DESTINATION#1=PORT1,PORT3,TCPC2"
STRM.SOURCE#n	Source scale	0-8 (0 is a source of none)
STRM.STREAM#n	Stream frame update rate	OFF, LFT, INDUST
STRM.GROSS#n	Mode token when streaming the Gross weight	Up to 8 alphanumeric characters
STRM.NET#n	Mode token when streaming the Net weight	Up to 8 alphanumeric characters
STRM.PRI#n	Units token when streaming Primary units	Up to 8 alphanumeric characters
STRM.SEC#n	Units token when streaming Secondary units	Up to 8 alphanumeric characters
STRM.TER#n	Units token when streaming Tertiary units	Up to 8 alphanumeric characters
STRM.INVALID#n	Status token when streaming an Invalid weight	Up to 2 alphanumeric characters
STRM.MOTION#n	Status token when the weight is in motion	Up to 2 alphanumeric characters
STRM.POS#n	Polarity token when the weight is positive	SPACE, NONE, +
STRM.NEG#n	Polarity token when the weight is negative	SPACE, NONE, -
STRM.OK#n	Status token when the weight is OK (not invalid, out of range, at zero, or in motion)	Up to 2 alphanumeric characters
STRM.TARE#n	Mode token when streaming the tare weight	Up to 8 alphanumeric characters
STRM.ZERO#n	Status token when the weight is at Center of Zero	Up to 2 alphanumeric characters
STRM.RANGE#n	Status token when the weight is Out of Range	Up to 2 alphanumeric characters
For commands with #n, n is the Stream format (1-4)		

Table 16-8. Stream Formatting Commands

## CPU Ports

- Ports 1 and 2 are the two CPU board RS232/485/422 ports
- Port 3 is the USB Device Port
- Ports 5 through 16 are assigned to dual serial option cards installed in slots 1-6

*Example: a serial option card in slot 1 has ports 5 and 6; if installed in slot 6, the card has ports 15 and 16.*

For port 3 (USB), the only parameters which matter are INPUT, TERMIN, ECHO, RESPONSE, EOLDLY and ALIAS. All other parameters are ignored.

## 16.4.3 Feature Commands

Command	Description	Values
DATEFMT	Date format	MMDDYYYY, DDMMYYYY, YYYYMMDD, YYYYDDMM
DATESEP	Date separator	SLASH, DASH, SEMI
TIMEFMT	Time format	12HOUR, 24HOUR
TIMESEP	Time separator	COLON, COMMA
DECfmt	Decimal format	DOT, COMMA
TIMEDATELOCK	Returns current status, only work in setup mode	OFF, ON
CONSNUM	Consecutive numbering	0-9999999; can be checked in weigh mode, but not changed in weigh mode
CONSTUP	Consecutive number start-up value	0-9999999
UID	ID of the indicator	Up to 8 alphanumeric characters; can be checked in weigh mode, but not changed in weigh mode
ALIBI	Alibi data storage	OFF, ON
CONTRAST	Adjusts the contrast level	0-255
CFGPWD	Configuration password	Up to 12 alphanumeric characters; set as nothing (no characters) for no password; 999999 is the rescue password, it resets all parameters to factory defaults, do not use it as a password
SPPWD	Setpoint password	Up to 12 alphanumeric characters; set as nothing (no characters) in order to not have a password
CALPWD	Calibration password	Up to 12 alphanumeric characters; set as nothing (no characters) in order to not have a password
SK.OP#1 – SK.OP#32	Softkey assignment	NONE, TIMEDATE, DATABASE, DSPTAR, DSPACC, DSPROC, SETPT, BATSTRT, BATSTOP, BATPAUSE, BATRST, UID, SCLSEL, SKUD1-SKUD10, BLANK, DIAG, ALIBI, CONTRAST, TEST, STOP, GO, OFF
SKT.TEXT#1 - SKT.TEXT#10	User-defined (SKUD1-SKUD10) softkey text	Up to 20 alphanumeric characters
OSKYPD	Enables the on-screen fly out keypad	OFF, ON
OSKYPDLK	Locks the on-screen fly out keypad in place, instead of closing it automatically when a button is pressed	OFF, ON
KYBDLK	Keyboard lock (disable keypad)	OFF, ON
ZERONLY	Disable all keys except ZERO	OFF, ON
DISPLAY.SOFTKEYS	Auto populate softkeys permanently (not using the softkey widget)	OFF, ON
CONTACT.COMPANY	Contact company name	Up to 30 alphanumeric characters
CONTACT.ADDR1 CONTACT.ADDR2 CONTACT.ADDR3	Contact company address	Up to 30 alphanumeric characters (for each line)
CONTACT.NAME1 CONTACT.NAME2 CONTACT.NAME3	Contact names	Up to 20 alphanumeric characters (for each line)
CONTACT.PHONE1 CONTACT.PHONE2 CONTACT.PHONE3	Contact phone numbers	Up to 20 alphanumeric characters (for each line)
CONTACT.EMAIL	Contact e-mail address	Up to 30 alphanumeric characters
CONTACT.NEXTCAL	Next calibration date	Date MMDDYYYY as an 8-digit number
CONTACT.LASTCAL	Last calibration date	Date MMDDYYYY as an 8-digit number
LOCALE	Enable gravity compensation	OFF, ON
LAT.LOC	Origin latitude (to nearest degree) for gravity compensation	0-90
ELEV.LOC	Origin elevation (in meters) for gravity compensation	±0-9999
DEST.LAT.LOC	Destination latitude (in degrees) for gravity compensation	0-90
DEST.ELEV.LOC	Destination elevation (in meters) for gravity compensation	±9999

Table 16-9. Feature Commands

Command	Description	Values
AUTOBKLGHT	Auto backlight control	OFF, ON
BKLGHT	The brightness of the backlight	OFF, LOW, MED, HIGH
LOCALREMOTE SERVERADDRESS	IP Address of the Local in a Local/Remote Application <b>NOTE: If not a Local/Remote application, the IP address must be set to 127.0.0.1.</b>	Valid IP xxx.xxx.xxx.xxx*
LANGUAGE	Sets the default display language	EN (English), ES (Spanish), FR (French), PT (Portuguese), IT (Italian), DE (German), NL (Dutch), DA (Danish), SV (Swedish), RU (Russian), UK (Ukrainian), HE (Hebrew), TH (Thai), ZH (Chinese), AR (Arabic), TR (Turkish)
ADVPRN.MANUFACT URER	Advanced printer manufacturer	Alphanumeric string
ADVPRN.MODEL	Advanced printer model name	Alphanumeric string
ADVPRN.DEVICE.URI	Advanced printer device URI	Alphanumeric string
FTP.ENABLED	Enables the FTP service	ON, OFF
FTP.PASSWORD	Password to use for the FTP service	Alphanumeric string

Table 16-9. Feature Commands (Continued)

## 16.4.4 Regulatory Commands

Command	Description	Values
REGULAT	Regulatory mode	NONE, NTEP, OIML, CANADA, AUSTRALIA, INDUST
AUDAGNCY	Audit agency (Industrial Mode)	NONE, NTEP, OIML, CANADA, AUSTRALIA, INDUST, INMETRO, NMI
REG.SNPSHOT	Display or scale weight source	DISPLAY, SCALE
REG.HTARE	Allow tare in display hold	NO, YES
REG.ZTARE	Remove tare on ZERO	NO, YES
REG.KTARE	Always allow keyed tare	NO, YES
REG.MTARE	Multiple tare action	REPLACE, REMOVE, NOTHING
REG.NTARE	Allow negative tare	NO, YES
REG.CTARE	Allow Clear key to clear tare/accumulator	NO, YES
REG.SOURCEZT	Clear Tare scales individually	NO, YES
REG.NEGTOTAL	Allow total scale to display negative value	NO, YES
REG.PRTMOT	Allow print while in motion	NO, YES
REG.PRINTPT	Add PT to keyed tare print	NO, YES
REG.PRTHLD	Print during display hold	NO, YES
REG.HLDWGH	Allow weighment during display hold	NO, YES
REG.MOTWGH	Allow weighment in motion	NO, YES
REG.OVRBASE	Zero base for overload calculation	CALIB_ZERO, SCALE_ZERO
REGWORD	Regulatory word	GROSS, BRUTTO
REG.RTARE	Round the Pushbutton Tare	NO, YES
REG.RKTARE	Round the Keyed Tare	NO, YES
REG.AZTNET	Perform AZT on Net value	NO, YES
REG.MANUALCLEARTARE	Allows manual clearing of the tare value	NO, YES
REG.MONORAIL	Monorail mode	NO, YES
REG.TAREINMOTION	Allows Tare in Motion	NO, YES
REG.UNDERLOAD	Underload weight value in display divisions	1-9999999
REG.ZEROINMOTION	Allows scale to be zeroed while in motion	NO, YES
REG.DISPLAYCAPACITY	Allows the scale widget to display the capacity	NO, YES
REG.DISPLAYCOUNTBY	Allows the scale widget to display the count-by	NO, YES
SCRN.SAVE	Enables screen saver	ON, OFF
SCRN.THRESH	Screen saver weight threshold	0-1000
SCRN.TIME	Screen saver activation time (in seconds)	10-120

Table 16-10. Regulatory Commands

Command	Description	Values
BATCHNG	Batching mode	OFF, AUTO, MANUAL
SP.KIND#n	Setpoint kind	OFF, GROSS, NET, -GROSS, -NET, ACCUM, +REL, -REL, %REL, PAUSE, DELAY, WAITSS, COUNTER, AUTOJOG, COZ, INMOTON, INRANGE, BATCHPR, TIMER, CONCUR, DIGIN, TOD, ALWAYS, NEVER, DINCNT, DELTA
SP.VALUE#n	Setpoint value	0.0–9999999
SP.SOURCE#n	Source scale	SCALEn (n=1–8)
SP.TRIP#n	Trip	HIGHER, LOWER, INBAND, OUTBAND
SP.BANDVAL#n	Band value	0.0–9999999
SP.HYSTER#n	Hysteresis	0.0–9999999
SP.PREACT#n	Preact type	OFF, ON, LEARN, FLOW
SP.PREVAL#n	Preact value	0–9999999
SP.PREADJ#n	Preact adjustment percentage	0–100
SP.PRESTAB#n	Preact learn stability	0–65535 (in tenths of a second, 15=1.5 seconds)
SP.PCOUNT#n	Preact learn interval	1–65535
SP.TOLBAND#n	Target tolerance	0.0–9999999
SP.TOLCNT#n	Tolerance count	0–65535
SP.BATCH#n	Batch step enable	OFF, ON
SP.CLRACCM#n	Clear accumulator enable	OFF, ON
SP.CLRTARE#n	Clear tare enable	OFF, ON
SP.PSHACCM#n	Push accumulate	OFF, ON, ONQUIET
SP.PSHPRINT#n	Push print	OFF, ON, WAITSS
SP.PSHTARE#n	Push tare	OFF, ON
SP.ALARM#n	Alarm enable	OFF, ON
SP.ALIAS#n	Setpoint name	Up to 8 alphanumeric characters
SP.ACCESS#n	Setpoint access	OFF, ON, HIDE
SP.DSLOT#n	Digital output slot	NONE, 0, 1, 2, 3, 4, 5, 6
SP.DIGOUT#n	Digital output	1–24
SP.SENSE#n	Digital output sense	NORMAL, INVERT
SP.BRANCH#n	Branch destination	0–100 (0 = do not branch)
SP.RELNUM#n	Relative setpoint number	1–100
SP.START#n	Starting setpoint	1–100
SP.END#n	Ending setpoint	1–100
SP.DISLOT#n	Digital input slot	NONE, 1, 2, 3, 4, 5, 6
SP.MASK#n	Digital input mask	0–16777216
SP.TIME#n	Trip time	hhmm
SP.DURATION#n	Trip duration	hhmmss
SP.ENABLE#n	Setpoint enable	OFF, ON

For setpoint commands ending with #n, n is the setpoint number (1–100)

Table 16-11. Setpoints Commands

## 16.4.5 Print Format Commands

Command	Description
GFMT GFMT.PORT GFMT.PORT2	Gross demand print format string
NFMT NFMT.PORT NFMT.PORT2	Net demand print format string
ACC.FMT ACC.PORT ACC.PORT2	Accumulator print format string
SPFMT.FMT SPFMT.PORT SPFMT.PORT2	Setpoint print format string
ALERT.FMT ALERT.PORT ALERT.PORT2	Alert format string
HDRFMT1 HDRFMT2	Ticket header format strings
AUXFMT.FMT#nn AUXFMT.PORT#nn AUXFMT.PORT2#nn	Auxiliary ticket format
AUD.PORT AUD.PORT2	Audit trail port

Table 16-12. Print Format Commands

Each format can be sent out through one or two destination ports ( .PORT and .PORT2); to specify the name of the printer to be accessed through that destination port, follow the destination port command with “=” and enter one of the following:

- NONE - No print
- USBPRN - USB Printer
- ADVPRN - Advanced Printer
- EMAIL - Email
- PORT1 - Serial Port 1
- PORT2 - Serial Port 2
- PORTn (n=5–16) - Option Cards
- TCPC1 - TCP Client 1
- TCPC2 - TCP Client 2
- TCPC3 - TCP Client 3

*Example: To send the Gross format out to printers at both Serial Port 2 and the TCP Client 1 destination ports at the same time, send:*

*GFMT.PORT=PORT2*

*GFMT.PORT2=TCPC1*

For AUXFMT.FMT and .PORT commands, specify the auxiliary format number (1–20) as .FMT#nn or .PORT#nn

*Example: AUXFMT.FMT#8=GROSS<G><NL2>...*

See [Section 7.0 on page 92](#) for information about print format strings



## 16.4.6 Display Widget Commands

Command	Description	Values
WDGT# <i>n</i>	Defines a display widget ( <i>n</i> =1–256)	See Examples below
WDGT.CLR	Clear widgets	Clears all display widgets.

Table 16-13. Display Widget Commands

**Example Scale Widget Command:** WDGT#A=1,B,C,D,E,F,G,H<CR>

where – A: widget number; B: left; C: top; D: size 1–7; E: displayed 1–4; F: which screen 1–99; G: foreground color; H: background color

**Example Bitmap Widget Command:** WDGT#A=2,B,C,D,E,F,G,H,I,J<CR>

where – A: widget number; B: left; C: top; D: width; E: height; F: border (1 or 2); bitmap (1–3); G: alias; H: visible (1 or 2); I: which screen 1–99

**Example Bar Graph Widget Command:** WDGT#A=3,B,C,D,E,F,G,H,I,J,K,L,M,N,O,P<CR>

where – A: widget number; B: left; C: top; D: width; E: height; F: border; G: style(1–3); H: graduation (1 or 2); I: orientation (1–3); J: color; K: alias; L: source (1–3); M: field (1–3); N: subfield; O: visible (1 or 2); P: screen 1–99

**Example Label Widget Command:** WDGT#A=4,B,C,D,E,F,G,H,I,J,K,L,,M,N,O,P<CR>

where – A: widget number; B: left; C: top; D: width; E: height; F: text caption; G: border (1 or 2); H: justification (1–3); I: font; J: color; K: alias; L: source; M: field; N: subfield; O: visible; P: which screen 1-99

**Example Symbol Widget Command:** WDGT#A=6,B,C,D,E,F,G,H,I,J,K,L,,M,N,O

where – A: widget number; B: left; C: top; D: style (1–48); E: State (1–4) F: Color (1–16) G: alias; H: source; I: field; J: subfield; K: visible (1 or 2); L: which screen 1–99

**Example Chart Widget Command:** WDGT#A=8,B,C,D,E,F,G,H

where – A: widget number; B: left; C: top; D: width; E: height; F: Visible; G: Style; H: which screen (1–99)

See [Section 15.0 on page 141](#) for widget programming information

## 16.4.7 Digital Input/Output Commands

Command	Description	Values
DON. <i>b#s</i>	Set digital output on (active) at bit <i>b</i> , slot <i>s</i>	--
DOFF. <i>b#s</i>	Set digital output off (inactive) at bit <i>b</i> , slot <i>s</i>	--
DIO. <i>b#s</i>	Digital input function	OFF, INPUT, OUTPUT, PROGIN, ZERO, NT/GRS, TARE, UNITS, PRINT, ACCUM, SETPNT, TIMDATE, CLEAR, DSPTAR, KEY1, KEY2, KEY3, KEY4, KEY5, KEY6, KEY7, KEY8, KEY9, KEYDP, KEY0, ENTER, NAVUP, NAVDN, NAVLFT, NAVRGT, KBDLOC, HOLD, BATRUN, BATSTRT, BATPAUS, BATRESET, CLRCN, GROSS, NET, PRIM, SEC, TER, CLRTAR, CLRACC, BATSTOP, PULSEIN
DIO.ALIAS. <i>b#s</i>	Name for the DIO bit	Up to 16 alphanumeric characters

Valid bit values are 1–24; Valid slot values are 0 (onboard) to 6

Table 16-14. Digital I/O Commands

## 16.4.8 Analog Output Commands

Command	Description	Values
ALG.ALIAS# <i>s</i>	Analog output alias	Up to 8 alphanumeric characters
ALG.SOURCE# <i>s</i>	Analog output source	PROG, SCALE <sub>n</sub> (n=1–8)
ALG.MODE# <i>s</i>	Mode	GROSS, NET
ALG.OUTPUT# <i>s</i>	Type of output	0–10 V, 0–20 MA, 4–20 MA
ALG.ERRACT# <i>s</i>	Error action	FULLSC, HOLD, ZEROSC
ALG.MIN# <i>s</i>	Minimum value tracked	±9999999
ALG.MAX# <i>s</i>	Maximum value tracked	±9999999

For commands ending with #*s*, *s* is the analog output number; analog outputs are numbered based on the slot in which they are installed  
Example: Slot 1 has output 1 (and 2 if dual), Slot 2 has output 3 (and 4 if dual)

Table 16-15. Analog Output Commands

## 16.4.9 Fieldbus Commands

Command	Description	Values
FB.BYTESWAP# <i>s</i>	Swap data bytes	NONE, BYTE, WORD, BOTH
FB.SIZE# <i>s</i>	Number of bytes to transfer	0–128 (0=disabled)
FB.DVCNET# <i>s</i>	DeviceNet address	1–64
FB.PRFBUS# <i>s</i>	Profibus address	1–126

For commands ending with #*s*, *s* is the slot number (1–6)

Table 16-16. Fieldbus Commands

## 16.5 Weigh Mode Commands

These commands function in the weighing mode. Non weight related commands also work in configuration modes.

Command	Description	Values
CONSNUM	Set consecutive number	0–9999999; can be checked in weigh mode, but not changed in weigh mode
UID	Set unit ID	Up to 8 alphanumeric characters; can be checked in weigh mode, but not changed in weigh mode
SD	Set or return the current system date	MMDDYY, DDMMYY, YYMMDD, or YYDDMM; enter six-digit date using the year-month-day order specified for the DATEFMT parameter, using only the last two digits of the year; the current system date is returned by only sending <b>SD</b>
ST	Set or return the current system time	hhmm (enter using 24-hour format) The current system time is returned by only sending <b>ST</b>
SX# <i>n</i>	Start serial data stream <i>n</i> (n=1–4)	OK or ??
EX# <i>n</i>	Stop serial data stream <i>n</i> (n=1–4)	An EX command sent while in setup mode does not take effect until the indicator is returned to weigh mode

Table 16-17. Weigh Mode Commands

Command	Description	Values
RS	Reset system	Soft reset; used to reset the indicator without resetting the configuration to the factory defaults
SF#n	Returns a single stream frame from scale n (n=1–8) using the standard Rice Lake format	--
XAF#n	Returns the accumulator value in displayed units as a 15 digit value	nnnnnnnnnnnnnn UU
XA#n	Returns the accumulator value in displayed units	nnnnnnnnn UU
XAP#n	Returns the accumulator value in primary units	
XAS#n	Returns the accumulator value in secondary units	
XAT#n	Returns the accumulator value in tertiary units	
XG#n	Returns the gross weight in displayed units	nnnnnnnnn UU
XGP#n	Returns the gross weight in primary units	
XGS#n	Returns the gross weight in secondary units	
XGT#n	Returns the gross weight in tertiary units	
XN#n	Returns the net weight in displayed units	nnnnnnnnn UU
XNP#n	Returns the net weight in primary units	
XNS#n	Returns the net weight in secondary units	
XNT#n	Returns the net weight in tertiary units	
XT#n	Returns the tare weight in displayed units	nnnnnnnnn UU
XTP#n	Returns the tare weight in primary units	
XTS#n	Returns the tare weight in secondary units	
XTT#n	Returns the tare weight in tertiary units	
XP#n	Return probe temperature	nnnnnnnnn UU
XPP#n	Return probe primary temperature	
XPS#n	Return probe secondary temperature	
XPT#n	Return probe tertiary temperature	

Unless otherwise specified, n= Scale Number, 1–8; if the scale number is omitted, the value returned is for the currently selected scale

Table 16-17. Weigh Mode Commands (Continued)

## 16.6 Batching Control Commands

The commands listed in [Table 16-18](#) provide batching control through a communications port.

Command	Description	Values
BATSTART	Batch Start	If the BATRUN digital input is active or not assigned, the BATSTART command can be used to start the batch program
BATSTOP	Batch Stop	Stops an active batch and turns off all associated digital outputs; requires a Batch Start to resume processing
BATPAUSE	Batch Pause	Pauses an active batch and turns off all digital outputs except those associated with Concurrent and Timer setpoints; processing is suspended until the indicator receives a Batch Start signal; pressing the BATSTRT digital input, BATSTART serial command, Batch Start softkey or the StartBatch function (in iRite) resumes the batch and re-energizes all digital outputs turned off by the Batch Pause
BATRESET	Batch Reset	Stops the program and resets the batch program to the first batch step; use the BATRESET command after making changes to the batch configuration
BATSTATUS	Batch Status	Returns XYYY where X is S (if the batch is stopped), P (if the batch is paused), R (if the batch is running); and YYY is the setpoint number the batch is currently on (1–100)

Table 16-18. Batching Control Commands

## 16.7 Database Commands

These commands can be used to create and maintain databases in the 1280. Except for the **DB.DELALL** command, all of the database commands require an extension to identify the number of the database within the memory.

Command	Description
DB.ALIAS# <i>n</i>	Get or set database name
DB.CLEAR# <i>n</i>	Clear database contents
DB.DATA# <i>n</i>	Get or set database contents
DB.SCHEMA# <i>n</i>	Get or set database structure
DB.DELALL	Delete all databases and database contents
<i>n</i> represents the database number ( <i>n</i> = 1–128)	
Each command must be terminated with a carriage return character (<CR>, ASCII 13)	

Table 16-19. Database Commands

### db.alias

The **DB.ALIAS** command is used to get or set the alias used by iRite programs to reference the specified database. Each database alias must be unique among all databases and adhere to the following rules: 8 character maximum; must begin with an alpha character or an underscore; can only contain A–Z, a–z, 0–9, or an underscore (\_).

*Example: The following command assigns an alias of TRUCKS\_2 to the first database:*

```
DB.ALIAS#1=TRUCKS_2<CR>
```

Sending the **DB.ALIAS** command alone, without assigned data, returns the current database alias.

```
db.clear
```

To clear the contents of a database, send the following command:

```
DB.CLEAR#n
```

Where:

**n** is the database number

The 1280 responds with **OK** if the command is successful, **??** if unsuccessful.

```
db.data
```

The **DB.DATA** command can be used to send data to or retrieve data from the 1280.

Data can be sent to the indicator using the following command:

```
DB.DATA#n = data{ | }<CR>
```

Where:

**n** is the database number

**data** represents a single cell of a row of data

{ | } is a pipe character (ASCII 124), used to delimit cell data. If the data being sent is not the last cell of the row, append the pipe character to the data to indicate more data is coming for the particular row. If the data being sent is the last cell of the row, do not append the pipe character.

If the command is accepted, the 1280 responds with **OK**; if not, it responds with **??**.

*Example: the following commands place the data in Table 16-20 into the first database:*

```
DB.DATA#1=this|<CR>      DB.DATA#1=aaa|<CR>
DB.DATA#1=is|<CR>        DB.DATA#1=bbb|<CR>
DB.DATA#1=a|<CR>         DB.DATA#1=ccc|<CR>
DB.DATA#1=test<CR>      DB.DATA#1=ddd<CR>
```

Record	Cell			
	1	2	3	4
first	this	is	a	test
second	aaa	bbb	ccc	ddd

Table 16-20. Database Commands Example

Sending the **DB.DATA** command alone, without assigned data, returns the database contents:

```
DB.DATA#n<CR>
```

The 1280 responds with the entire contents of the database. Returned data is cell-delimited with the pipe character (ASCII 124) and row-delimited with carriage returns (ASCII 13).

For example, the following command could be used to return the contents of database 1:

```
DB.DATA#1<CR>
```

If the database contents are the records in [Table 16-20](#), the indicator responds with the following data, using pipe characters and carriage returns to delimit the database cells and rows, respectively:

```
this|is|a|test<CR>aaa|bbb|ccc|ddd<CR>
```



**NOTE:** There is no end of database notification at the end of the **DB.DATA** command transmission. Use a receive time-out to determine command completion. The time-out value varies based on baud rate.

Determine the number of records currently in the database both prior to and after sending the **db.data** command to verify the correct number of records are received. The number of records can be determined with the **DB.SCHEMA** command.

```
db.schema
```

The **DB.SCHEMA** command is used to get or set the structure of a database.

```
DB.SCHEMA#n<CR>
```

The 1280 responds to the command above by returning the following:

```
<Max Records>,<Current Record Count>,  
<Column Name>,<Data Type>,<Data Size>,...<CR>
```

The <Column Name>, <Data Type>, and <Data Size> elements repeat for each column in the database.

The <Column Name> follows the rules for alias names: 8 character maximum; must begin with an alpha character or an underscore; can only contain A–Z, a–z, 0–9, or an underscore (\_).

The <Data Type> is represented by a numeric field:

Value	Type
1	Byte
2	Short (16-bit integer)
3	Long (32-bit integer)
4	Single (32-bit floating point)
5	Double (64-bit floating point)
6	Fixed string
7	Variable string
8	Date and time

Table 16-21. Database Data Types

The <Data Size> value must match the data type. A range of data size values is allowed only for the string data types:

Size	Value
Byte	1
Short	2
Long	4
Single	4
Double	8
Fixed string	1–255
Variable string	1–255
Date and time	8

Table 16-22. Database Data Sizes

The **DB.SCHEMA** command can also be used to modify the schema, but only when the indicator is in setup mode and only if the database does not contain any data.

## 16.8 iQUBE<sup>2</sup> Configuration Commands

The 1280 contains the configuration of any connected iQUBE<sup>2</sup>. This configuration is stored using the already existent iQUBE<sup>2</sup> EDP command, but in a specialized format. For a complete list of iQUBE<sup>2</sup> commands, reference the iQUBE<sup>2</sup> Manual (PN 67888).



**NOTE:** This is only valid for iQUBE<sup>2</sup> configuration commands stored in the 1280 and is not direct a real-time pass through connection to the iQUBE<sup>2</sup>. Weigh mode commands and some system commands are not supported.

Format: SJ.<iQUBE2-EDP-Command>#<Connection Port>

Example 1:

Set Unit ID of iQUBE<sup>2</sup> Scale 1 to 123

iQUBE<sup>2</sup> EDP Command: SC1.UID=123

1280 Port which the iQUBE<sup>2</sup> is connected to: Port 2

EDP Command for the 1280 then becomes: SJ.SC1.UID#PORT2=123

Example 2:

Set iQUBE<sup>2</sup> capacity of load cell number 6 to 25,000

iQUBE<sup>2</sup> EDP Command: LC6.CAPACITY=25000

1280 Port which the iQUBE<sup>2</sup> is connected to: TCP Client1

EDP Command for the 1280 then becomes: SJ.LC6.CAPACITY#TCPC1=25000

## 16.9 1280 Calibration Using Serial Commands

Use the following instructions to calibrate the 1280 using serial commands. For information on how to calibrate the 1280 using the front panel, see [Section 4.2 on page 65](#).



**NOTE:** The indicator must respond with OK after each step. If it does not, the calibration procedure does not work and may have to be done again.

1. Press  to enter the Configuration menu.
2. To start the calibration process, send the command **SC.CALSTART.n#s**. Replace **s** with the scale number, and **n** with 1 for a standard calibration, 2 to use the last calibrated zero or 3 to use the scale's temporary zero.
3. For a standard calibration, remove all weight from the scale (except hooks or chains which are needed to attach weights). For last or temporary zero, skip to [Step 5](#).
4. Send the command **SC.WZERO#s** to calibrate the zero point. Wait 10-seconds before proceeding.
5. Apply the span calibration weight to the scale.
6. Send the command **SC.WVAL#s=xxxxx**, where **xxxxx** is the exact value of the span calibration weight applied to the scale.
7. Send the command **SC.WSPAN#s** to calibrate the span point. Wait 10-seconds before proceeding. Continue on to [Step 8](#) to calibrate additional linearization points, or proceed to [Step 12](#).
8. Apply weight equal to the first linearization point to the scale.
9. Send the command **SC.WLINn#s=xxxxx**, where **n** is the linearization point number (1–4) and **xxxxx** is the exact value of the weight applied.
10. Send the command **SC.WLIN.Cn#s** to calibrate the linearization point. Wait 10-seconds before proceeding.
11. Repeat [Step 9](#) and [Step 10](#) for up to four total linearization points.
12. If hooks or chains were used to attach the weights, remove all weight, including the hooks and chains, and send the command **SC.REZERO#s** to remove the zero offset.
13. Send the command **SC.CALEND#s** to complete the calibration process.
14. Save the calibration values. Wait 10-seconds before proceeding.
15. Send the command **KCOMMIT** to commit the new values to memory.
16. Send the command **KSAVEEXIT** to return to weigh mode (or press the **Save and Exit** icon on the display).



## 16.10 Net Update Commands

The following commands can be used to update the 1280.

Command	Function
netupdate.enable	Enables or Disables the Netupdate feature (setup mode only)
netupdate.status	Returns the current status of Netupdate (weigh or setup mode)
netupdate.check	Checks website for newer version of firmware; Returns the current status of Netupdate (weigh or setup mode)
netupdate.mandumplog	Displays manifest check or net update log files (this log is for the last executed manifest command)
netupdate.netdumplog	Displays log for the last net firmware update installed

*Table 16-23. Net Update Commands*

# 17.0 Compliance

	<p><b>EU DECLARATION OF CONFORMITY</b></p> <p><i>EU-KONFORMITÄTSERKLÄRUNG DÉCLARATION UE DE CONFORMITÉ</i></p>	<p>Rice Lake Weighing Systems 230 West Coleman Street Rice Lake, Wisconsin 54868 United States of America</p> 						
<p><b>Type/Typ/Type:</b> 1280 Series</p>								
<p>English We declare under our sole responsibility that the products to which this declaration refers to, is in conformity with the following standard(s) or other regulations document(s).</p> <p>Deutsch Wir erklären unter unserer alleinigen Verantwortung, dass die Produkte auf die sich diese Erklärung bezieht, den folgenden Normen und Regulierungsbestimmungen entsprechen.</p> <p>Francais Nous déclarons sous notre responsabilité que les produits auxquels se rapporte la présente déclaration, sont conformes à la/aux norme/s suivante ou au/aux document/s normatif/s suivant/s.</p>								
EU Directive	Certificates	Standards Used / Notified Body Involvement						
2014/35/EU low voltage	-	EN 62368-1:2014 + A11:2017						
2014/30/EU EMC	-	EN 55022:2010 + AC:2011, EN 61000-6-2:2005 + AC:2005, EN 61326-1:2012						
2014/53/EU Radio	-	EN 301489-17:2012, EN301489-1:2011, EN 300328 V2.1.1						
2011/65/EU RoHS	-	EN 50581:2012						
<table style="width: 100%; border: none;"> <tr> <td style="width: 50%; border: none;">                 Signature: <u>Brandi Harder</u> </td> <td style="width: 50%; border: none;">                 Place: <u>Rice Lake, WI USA</u> </td> </tr> <tr> <td style="border: none;">                 Name: <u>Brandi Harder</u> </td> <td style="border: none;">                 Date: <u>February 7, 2021</u> </td> </tr> <tr> <td style="border: none;">                 Title: <u>Quality Manager</u> </td> <td style="border: none;"></td> </tr> </table>			Signature: <u>Brandi Harder</u>	Place: <u>Rice Lake, WI USA</u>	Name: <u>Brandi Harder</u>	Date: <u>February 7, 2021</u>	Title: <u>Quality Manager</u>	
Signature: <u>Brandi Harder</u>	Place: <u>Rice Lake, WI USA</u>							
Name: <u>Brandi Harder</u>	Date: <u>February 7, 2021</u>							
Title: <u>Quality Manager</u>								

Form 1126 Rev. 2 01/2022

Approved by: Quality Department



# UK CA

## UK DECLARATION OF CONFORMITY

Rice Lake Weighing Systems  
230 West Coleman Street  
Rice Lake, Wisconsin 54868  
United States of America

**RICE LAKE**  
WEIGHING SYSTEMS

**Type:** 1280 Series

English We declare under our sole responsibility that the products to which this declaration refers to, is in conformity with the following standard(s) or other regulations document(s).

UK Regulations	Certificates	Standards Used / Approved Body Involvement
2016/1101 Low Voltage	-	EN 62368-1:2014 + A11:2017
2016/1091 EMC	-	EN 55022:2010 + AC:2011, EN 61000-6-2:2005 + AC:2005, EN 61326-1:2012
2017/1206 Radio	-	EN 301489-17:2012, EN301489-1:2011, EN 300328 V2.1.1
2012/3032 RoHS	-	EN 50581:2012

Signature: Brandi Harder

Place: Rice Lake, WI USA

Name: Brandi Harder

Date: February 7, 2021

Title: Quality Manager

## 18.0 Specifications

### Power:

AC voltages: 100 to 240 VAC; 50 /60 Hz  
DC voltages: 11 to 30 VDC

### Power Consumption:

60W

### Excitation Voltage:

10 VDC (+/- 5 VDC)  
16 × 350 ohm or 32 × 700 ohm load cells per A/D card

### Analog Signal Input Range:

-60 mV to 60 mV

### Analog Signal Sensitivity:

0.3  $\mu$ V/graduation minimum at 7.5 Hz to 120 Hz  
1.0  $\mu$ V/graduation recommended

### A/D Sample Rate:

7.5 to 960 Hz, software selectable

### Resolution:

Internal: 8,000,000 counts  
Display: 1,000,000

### System Linearity:

$\pm$  0.01% full scale

### Digital I/O:

Eight I/O channels on CPU board  
Optional 24-channel I/O expansion boards

### Communication Ports:

Port 1 & 2: Full duplex RS-232 with CTS/RTS,  
RS-422/485  
Baud rate: 1200 to 115200  
Port 3: USB 2.0 Device (Micro)  
USB host: (2) Type A connectors max 500 mA  
Ethernet: Wired 10/100 Auto-MDX  
Ethernet: Wireless 802.11 b/g/n 2.4GHz

### Onboard:

Selectable filters: Three stage, adaptive or damping  
Embedded Linux® OS  
8 GB eMMC (system use)  
1 GB DDR3 RAM  
460 MB onboard database (SQLite) storage  
Up to 32 GB micro SD card (sold separately)

### Display:

Seven-inch, 800 × 480 pixel, 500 or 1,000 NIT  
Twelve-inch, 1280 × 800 pixel, 1,500 NIT

### Keys/Buttons:

22-key membrane panel, tactile buttons, on-screen  
keyboard for text and numeric entry, USB port for  
flash drive, keyboard and printer

### Temperature Range:

Certified: 14 °F to 104 °F (-10 °C to 40 °C)  
Operating: -4 °F to 131 °F (-20 °C to 55 °C)

### Rating/Material:

Universal: IP69K  
Wall Mount: IP66  
Panel Mount: IP69K, NEMA Type 4X and 12  
Stainless steel 304 enclosure

### Weight:

Universal enclosure: 11 lb (4.9 kg)  
Panel mount enclosure: 8 lb (3.6 kg)  
Wall mount enclosure: 23 lb (10.4 kg)  
Panel mount 7 in touch-only: 7 lb (3.1 kg)  
Panel mount 12 in touch-only: 10 lb (4.5 kg)

### Warranty:

Two-year limited

### EMC Immunity:

10 V/m

## Certifications and Approvals



**NTEP**  
 CC Number: 15-001A1  
 Accuracy Class: III/IIIL;  $n_{\max}$ : 10 000



**OIML**  
 File Number: R76/2006-A-NL1-19.23  
 Accuracy Class: III/IIIL;  $n_{\max}$ : 10 000



**Measurement Canada**  
 Approved  
**Measurement Canada**  
 Approval: AM-5980C  
 Accuracy Class III/II HD  $n_{\max}$ : 10 000



**Australian Government**  
 Approved  
**Australian Government**  
 National Measurement Institute  
 Certificate of Approval: *Pending*



**NOM**  
 Certificate No. 1602CE12346



**UL Listed**  
 Universal, Wall Mount, DC Panel Mount



**UL Recognized**  
 AC Panel Mount



**Radio certificate number:**  
 US: TFB-1003  
 Canada: 5969A-1003









© Rice Lake Weighing Systems Content subject to change without notice.

230 W. Coleman St. • Rice Lake, WI 54868 • USA USA: 800-472-6703 • International: +1-715-234-9171