

882D

Belt Scale Integrator

Technical Manual



© Rice Lake Weighing Systems. All rights reserved.

Rice Lake Weighing Systems® is a registered trademark of
Rice Lake Weighing Systems.

All other brand or product names within this publication are trademarks or
registered trademarks of their respective companies.

All information contained within this publication is, to the best of our knowledge, complete and
accurate at the time of publication. Rice Lake Weighing Systems reserves the right to make
changes to the technology, features, specifications and design of the equipment without notice.

The most current version of this publication, software, firmware and all other product
updates can be found on our website:

www.ricelake.com

Revision History

This section tracks and describes manual revisions for awareness of major updates.

Revision	Date	Description
F	December 27, 2022	Established revision history; Revolution software and FCC statement update; UKCA declaration of conformity added; firmware version 2.04
G	September 19, 2023	Added power cord changes
H	November 7, 2023	Updated EPD commands list
I	April 26 2024	Added Belt speed control parameters; firmware version 2.05

Table i. Revision Letter History



Technical training seminars are available through Rice Lake Weighing Systems. Course descriptions and dates can be viewed at www.ricelake.com/training or obtained by calling 715-234-9171 and asking for the training department.

Contents

1.0	Introduction	9
1.1	Overview	9
1.2	Safety	9
1.3	FCC Compliance	10
1.4	Options	10
1.4.1	Available Option Cards	10
2.0	Installation	11
2.1	Unpacking	11
2.1.1	Product Dimensions	11
2.2	Mounting Instructions	12
2.3	Backplate Removal	12
2.4	Cable Connections	13
2.4.1	Load Cells	13
2.4.2	Cable Shield Grounding	13
2.4.3	Power Cable Grounding	14
2.4.4	Power Cables	15
2.4.5	Speed Sensor	15
2.4.6	Digital I/O	16
2.4.7	Serial Communications – Port 1 (COM)	16
2.4.8	USB Device Communications – Port 2 (USBCOM)	16
2.5	USB Host	17
2.6	Ethernet Communications	17
2.7	CPU Board	18
2.8	Audit Trail	18
2.9	Backplate Attachment	19
2.9.1	Sealing	19
2.10	Parts Kits Components	20
2.11	Replacement Parts	21
3.0	Operation	23
3.1	Operating Modes	24
3.2	Weigh Mode Selection	24
3.3	Audit Trail Information	25
3.4	Totalizers	25
3.4.1	Totalizer 1 and 2	25
3.4.2	Master Totalizer	26
4.0	Configuration	27
4.1	Setup Switch Configuration Access	27
4.2	User Menu Configuration Access	27
4.3	General Navigation	28
4.4	User Menu	29
4.5	Audit Menu	29
4.6	Setup Menu	29
4.6.1	Setup – Scale Menu	30
4.6.2	Setup – Features Menu	35
4.6.3	Setup – Ports Menu	37



Rice Lake continually offers web-based video training on a growing selection of product-related topics at no cost. Visit www.ricelake.com/webinars

4.6.4	Setup – Print Format Menu	39
4.6.5	Setup – Setpoints Menu	40
4.6.6	Setup – Digital I/O Menu	42
4.6.7	Setup – Analog Output Menu	43
4.6.8	Setup – Version Menu	44
4.7	Test Menu	45
4.8	Time & Date Menu	45
5.0	Calibration	46
5.1	Speed Sensor Calibration	46
5.1.1	Calculated	46
5.1.2	Revolutions	47
5.1.3	Distance	49
5.2	Weigh Frame Calibration	50
5.2.1	Static Zero	50
5.2.2	Dynamic Span	50
5.2.3	Dynamic Zero	52
5.2.4	Linearization	53
6.0	Using Revolution	55
6.1	Connecting to the 882D	55
6.2	Saving and Restoring Configuration Files	55
6.2.1	Uploading Configuration to Revolution	55
6.2.2	Downloading to the 882D	55
6.3	Updating the 882D CPU Firmware	56
7.0	EDP Commands	57
7.1	Reporting Commands	57
7.1.1	AUDITJUMPER	57
7.1.2	BUILD	57
7.1.3	DIN#s - Digital Input State	58
7.1.4	DISPLAYBUILD	58
7.1.5	DUMPAUDIT	58
7.1.6	FBTEST1-2	58
7.1.7	HARDWARE	59
7.1.8	OPTVERSION#s	59
7.1.9	P	59
7.1.10	Pn	59
7.2	Weigh Mode Commands	60
7.2.1	DISPLAYMODE Command	60
7.2.2	Totalizer Value Reporting	61
7.2.3	Load Value Reporting	61
7.2.4	Speed Value Reporting	61
7.2.5	Rate Value Reporting	61
7.2.6	XE and XEH Error Code Output	61
7.3	Key Press Commands	62
7.4	Batching Control Commands	63
7.5	Calibration Commands	63
7.5.1	Speed	63
7.5.2	Weigh Frame	63
7.6	RESETCONFIGURATION Command	63



Technical training seminars are available through Rice Lake Weighing Systems.
 Course descriptions and dates can be viewed at www.ricelake.com/training
 or obtained by calling 715-234-9171 and asking for the training department.

7.7	Parameter Setting Commands	64
7.7.1	Scale Menu	64
7.7.2	Time and Date Menu	66
7.7.3	Passwords Menu	67
7.7.4	Features Menu	67
7.7.5	Ports – COM Menu	67
7.7.6	Ports – USBCOM Menu	68
7.7.7	Ports – Ethernet Menu	68
7.7.8	Ports – Fieldbus Menu	69
7.7.9	Keypad Lock Menu	69
7.7.10	Setpoints Menu	70
7.7.11	Print Format Menu	72
7.7.12	Digital I/O Configuration Menu	72
7.7.13	Database Commands	73
7.7.14	Analog Output Menu	76
7.7.15	Digital Output Control Commands	76
8.0	Print Formatting	77
8.1	Print Formatting Tokens	77
8.2	Default Print Formats	78
8.3	Customizing Print Formats	79
8.3.1	Using the EDP Commands	79
8.3.2	Using the Front Panel	79
9.0	Ethernet	80
9.1	Ethernet Server/Client Connections	80
9.1.1	Direct Connection from a PC to the 882D Ethernet Server without a network (Ad-Hoc)	80
9.1.2	PC Connection to the 882D Ethernet Server Through a Network Switch or Router	81
9.1.3	Connection to a Remote Server - Demand Print to an Ethernet Printer	82
9.1.4	Connecting to a Remote Server - Stream weight data to an Ethernet Remote Display	82
9.1.5	Connecting to a Remote Server, Stream/Demand Data to Remote Ethernet-to-RS-232 Device Server	83
10.0	Setpoints	84
10.1	Batch and Continuous Setpoints	84
10.2	Batch Operations	85
10.3	Batching Example	86
11.0	Maintenance	87
11.1	Maintenance Checkpoints	87
11.2	Field Wiring	87
11.3	Troubleshooting Tips	87
11.4	Battery Replacement	88
11.5	Board Replacement	88
11.6	CPU Board Excitation Fuses	89
11.6.1	Fuse Check	89
11.6.2	Fuse Replacement	89
11.7	882D Permanent Field Record	90
12.0	Appendix	91
12.1	Error Messages	91
12.1.1	Displayed Error Messages	91
12.2	Using the HARDWARE Command	91



Rice Lake continually offers web-based video training on a growing selection of product-related topics at no cost. Visit www.ricelake.com/webinars

12.3 ASCII Character Chart 92

12.4 Data Formats 94

 12.4.1 Stream Serial Data Format 94

 12.4.2 Stream Tokens 94

 12.4.3 Print Output Serial Data Format 95

 12.4.4 RS-485 Data Formats 95

12.5 Analog Output Calibration 96

12.6 Cable Specifications 97

12.7 CPU Board Components 98

13.0 Compliance 99

14.0 Specifications 101



Technical training seminars are available through Rice Lake Weighing Systems. Course descriptions and dates can be viewed at www.ricelake.com/training or obtained by calling 715-234-9171 and asking for the training department.



Rice Lake continually offers web-based video training on a growing selection of product-related topics at no cost. Visit www.ricelake.com/webinars

1.0 Introduction

This manual is intended for use by service technicians responsible for installing and servicing the 882D Belt Scale Integrator.



Manuals are available from Rice Lake Weighing Systems at www.ricelake.com/manuals

Warranty information is available at www.ricelake.com/warranties

1.1 Overview

A belt conveyor scale continuously measures bulk material as it is moved along a conveyor. The system requires two general parameters to operate:

- Weight of the material being moved along the conveyor belt
- Speed at which the material is moved along the conveyor belt

The weight of the material on the belt is determined by weighing a section of the conveyor belt loaded with material and subtracting the average weight of the unloaded belt. The speed at which the material is moving is determined by measuring the speed of an idler or wheel in contact with the conveyor belt. The weight and speed are combined by the 882D to give a running total and a rate of flow for the material. Optimum operation of the scale system requires the components to be installed correctly, periodically calibrated and properly maintained.

1.2 Safety

Safety Definitions:



DANGER: Indicates an imminently hazardous situation that, if not avoided, will result in death or serious injury. Includes hazards that are exposed when guards are removed.



WARNING: Indicates a potentially hazardous situation that, if not avoided, could result in serious injury or death. Includes hazards that are exposed when guards are removed.



CAUTION: Indicates a potentially hazardous situation that, if not avoided, could result in minor or moderate injury.



IMPORTANT: Indicates information about procedures that, if not observed, could result in damage to equipment or corruption to and loss of data.

General Safety



Do not operate or work on this equipment unless this manual has been read and all instructions are understood. Failure to follow the instructions or heed the warnings could result in injury or death. Contact any Rice Lake Weighing Systems dealer for replacement manuals.



WARNING

Failure to heed could result in serious injury or death.

Some procedures described in this manual require work inside the enclosure. These procedures are to be performed by qualified service personnel only.

Ensure the power cord is disconnected from the power source before opening the unit.

Do not allow minors (children) or inexperienced persons to operate this unit.

Do not operate without enclosure completely assembled.

Do not place fingers into slots or possible pinch points.

Do not use this product if any of the components are cracked.

Do not exceed the rated load limit of the unit.

Do not make alterations or modifications to the unit.

Do not use for any purpose other than as a belt scale integrator.

Do not remove or obscure warning labels.

Do not submerge.

1.3 FCC Compliance

United States

This equipment has been tested and found to comply with the limits for a Class A digital device, pursuant to Part 15 of the FCC Rules. These limits are designed to provide reasonable protection against harmful interference when the equipment is operated in a commercial environment. This equipment generates, uses and can radiate radio frequency energy and, if not installed and used in accordance with the instruction manual, may cause harmful interference to radio communications. Operation of this equipment in a residential area is likely to cause harmful interference in which case the user will be required to correct the interference at his own expense.

Canada

This digital apparatus does not exceed the Class A limits for radio noise emissions from digital apparatus set out in the Radio Interference Regulations of the Canadian Department of Communications.

Le présent appareil numérique n'émet pas de bruits radioélectriques dépassant les limites applicables aux appareils numériques de la Class A prescrites dans le Règlement sur le brouillage radioélectrique édicté par le ministère des Communications du Canada.

1.4 Options

There are two option card slots, connectors J8 and J9, that can support Rice Lake option cards. Each option card kit includes instructions for installing and set up.

1.4.1 Available Option Cards

Single Analog Output – supports a single analog output

4-Channel Relay – supports 4 relay outputs

8-Channel Digital I/O (24V DC) – supports 8 digital inputs/outputs

24-Channel Digital I/O (TTL level) – supports 24 digital inputs/outputs

Fieldbus Carrier Board – only supported on slot 1 and supports the following modules:

- Ethernet/IP™
- PROFINET®
- DeviceNet®
- PROFIBUS®
- Modbus TCP/IP®
- EtherCAT®



NOTE: Refer to the *Interface Option Cards Installation and Programming Manual (PN 190906)* for Fieldbus command specifications.

Option Card Power Limitations

Only two of the following can be used simultaneously due to power limitations:

- Single Analog Output option card
- 24-Channel Digital I/O option card
- Pulse encoder that draws > 50 mA
- 5V on the Digital I/O connector > 100 mA

2.0 Installation

This section describes procedures for connecting power, load cells, speed sensor, digital I/O and data communications cables to the 882D. An assembly drawing and parts list are included for the service technician.



WARNING



Risk of electrical shock.

Risque de choc.

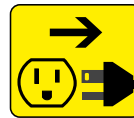

Disconnect power before servicing.

Débranchez l'alimentation avant l'entretien.



AVERTISSEMENT



CAUTION: Risk of explosion if battery is replaced by an incorrect type. Dispose of used batteries according to state and local regulations.



ATTENTION: Risque d'explosion si la batterie est remplacée par un type incorrect. Mettre au rebut les batteries usagées selon les règlements d'état et locaux.

- Use anti-static protection for grounding and to protect components from electrostatic discharge (ESD) when working inside the 882D enclosure.
- Procedures requiring work inside the 882D must be performed by qualified service personnel only.
- The power supply cord serves as the power disconnect for the 882D. The power receptacle to the 882D must be easily accessible.

2.1 Unpacking

Immediately after unpacking, visually inspect the 882D to ensure all components are included and undamaged. The 882D enclosure comes assembled to the universal mount. The shipping carton should also contain the parts kit ([Section 2.10 on page 20](#)) and the manuals. If any parts were damaged in shipment, notify Rice Lake Weighing Systems and the shipper immediately.

2.1.1 Product Dimensions

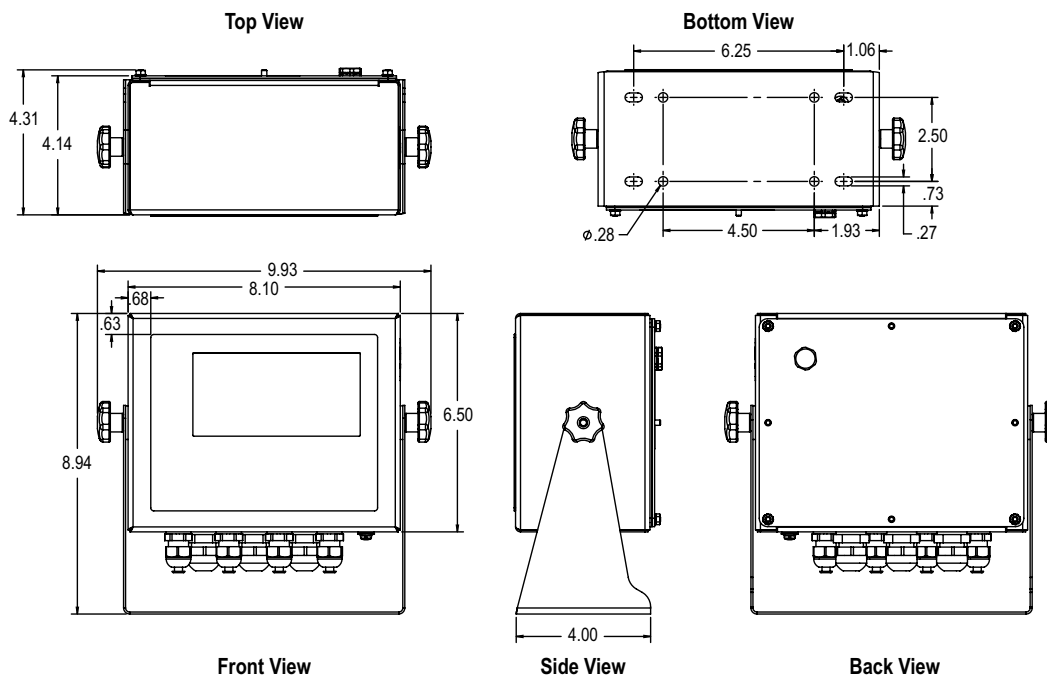

Figure 2-1. Product Dimensions

2.2 Mounting Instructions

The 882D includes a universal mount. The universal mount can be mounted on a wall, tabletop or any flat surface.



NOTE: The universal mount comes attached to the 882D. Rice Lake Weighing Systems recommends removing the 882D from the universal mount prior to mounting.



Figure 2-2. Mounting the 882D

1. Using the mount as a template, mark the screw locations.
2. Drill holes for the screws.
3. Secure the universal mount using the appropriate length 1/4" or M6 hardware (not included).
4. Reattach the 882D to the universal mount.

2.3 Backplate Removal

Remove the backplate of the 882D to connect cables for installed option cards and to gain access to the display board, CPU board and power supply board.



WARNING: The 882D has no on/off switch. Before removing the backplate and opening the unit, ensure the power cord is disconnected from the power receptacle.

1. Place the 882D face-down on an anti-static work mat.
2. Remove the M4 nuts holding the backplate to the enclosure with a 7 mm socket or wrench.
3. Lift the backplate away from the enclosure. Disconnect the ground wire from the backplate by removing the M4 nut with a 7mm socket or wrench and set it aside.

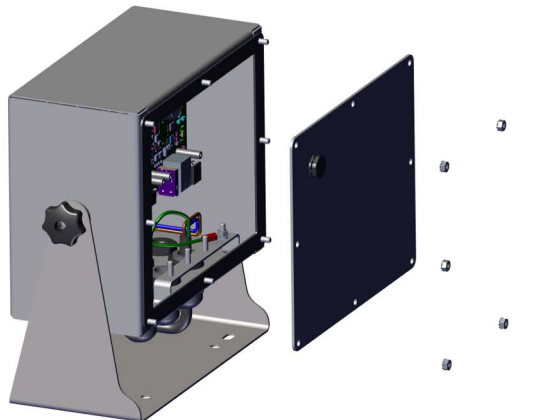

Figure 2-3. Removing the Backplate



NOTE: 882D ships with only four nuts securing the backplate. The remaining backplate nuts are included in the parts kit. For reassembly torque backplate nuts to 15 in-lb (1.7 N-m).

2.4 Cable Connections

The 882D has seven cord grips at the bottom of the enclosure, one is used for the power supply. The backplate must be removed to make connections to the load cells, speed sensor, communications, digital inputs and digital outputs. Plugs must remain in all unused cord grips to prevent moisture and dust from entering the enclosure. For recommended wire gauge and cord grip specifications refer to [Table 12-6](#) and [Table 12-7 on page 97](#). Torque cord grip nuts to 33 in-lb (3.7 N-m).



IMPORTANT: Do not have open/bare wires outside of the enclosure. Make sure no stripped portion of cable is on the outside of the cord grips.



WARNING: Power must be disconnected before servicing or installation. Failure to do so could result in electrical shock and damage to the CPU board.

2.4.1 Load Cells

To attach the cable from a load cell or junction box, route cable to the J1 connector ([Figure 2-9 on page 18](#)). Connector for the cable is included in the parts kit. Wire the load cell cable from the load cell or junction box to connector as shown in [Table 2-1](#). If using a 6-wire load cell cable (with sense wires), remove jumpers JP5 and JP6 ([Figure 2-9 on page 18](#)).



NOTE: For a 4-wire installation leave jumpers JP5 and JP6 in place and leave pins 3 and 4 empty on the connector.

Connector	Pin	Function
J1	1	+SIG
	2	-SIG
	3	+SENSE
	4	-SENSE
	5	+EXC
	6	-EXC

For 6-wire load cell connections, remove jumpers JP5 and JP6.

Table 2-1. J1 Pin Assignments

2.4.2 Cable Shield Grounding

Except for the power cord, all cables routed through the cord grips must be shield grounded against the enclosure.

- Use hardware provided in the parts kit to install shielding clamps on the grounding studs at the bottom of the enclosure
- Install only the necessary amount of shielding clamps for the cord grips to be used; finger tighten nuts at this time
- Route cables through the cord grips and shielding clamps to determine the cable lengths required to reach the appropriate cable connectors
- Mark the cables to remove the insulated jackets and shielding as described in the next two sections

Foil Shielded Cable

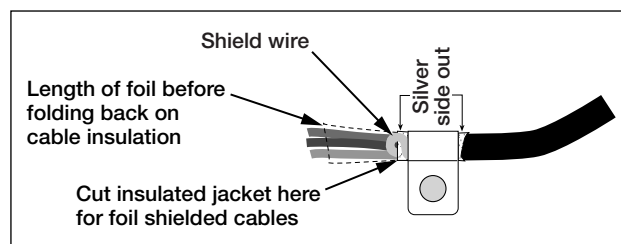

Figure 2-4. Foil Shielded Cable

1. Strip the insulated jacket and foil 1/2 in (15 mm) past the shielding clamp.
2. Strip another 1/2 in of the insulated jacket, leaving the foil shielding exposed.
3. Fold the foil shielding back on the cable where the cable passes through the clamp.
4. Ensure the silver (conductive) side of the foil is turned outward.
5. Wrap the shield wire around the cable so it contacts the foil where the cable passes through the clamp.
6. Torque the shielding clamp nut to 10 in-lb (1.13 N-m) so the clamp is around the cable and contacting the shield wire.

Braid Shielded Cable

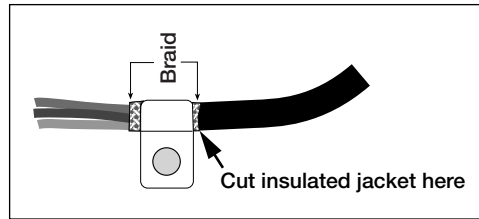

Figure 2-5. Braid Shielded Cable

1. Strip the insulated jacket and braided shielding from a point just past the shielding clamp.
2. Strip another 1/2" (15 mm) of the insulated jacket, leaving the braid exposed where the cable passes through the clamp.
3. Tighten the shielding clamp.

2.4.3 Power Cable Grounding

AC versions of the 882D are shipped with the AC power cable already installed and grounded to the enclosure. For DC versions of the 882D, use the following steps to ground and connect the DC power cable.

1. Run DC power cable (not included) up through the cord grip (Figure 2-6).



NOTE: For the recommended wire gauge refer to [Table 12-6 on page 97](#).

2. One wire will be terminated (grounded) at a stud near the cord grip using the proper grounding stack. The backplate ground is already attached to a stud. Remove it so that the power cord ground can be on the bottom of the stack as represented in Figure 2-6. Torque nuts to 10 in-lb (1.13 N-m).
3. Run the other two wires toward the back of the enclosure and connect them to the three pin plug (included in the parts bag) that connects into the power supply board as shown in Figure 2-6 and Table 2-2.

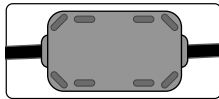

A ferrite from the parts kit must be applied to the DC power cable within 1" of the cord grip.

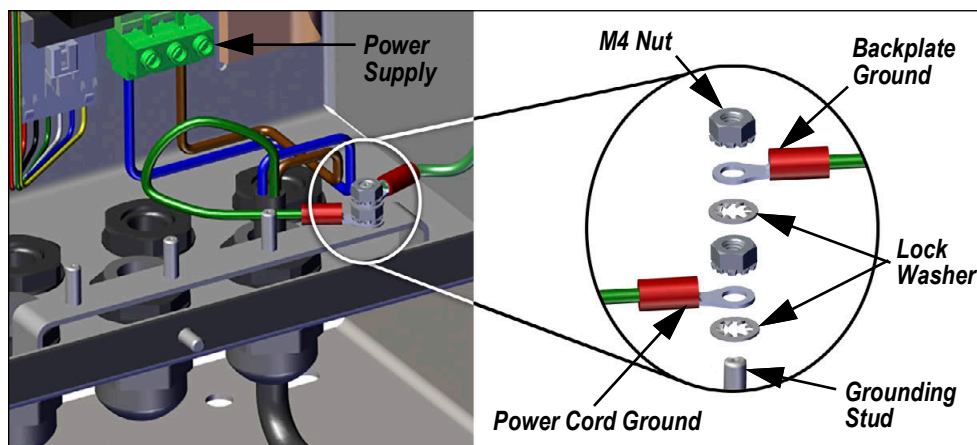

Figure 2-6. Connect DC Wiring

Pin	AC	DC
1	N	+
2	Chassis GND	Chassis GND
3	L	-

Table 2-2. Power Connection Pin Assignments

2.4.4 Power Cables

AC versions of the 882D are shipped with the AC power cable already installed.



Figure 2-7. AC Power Cable



NOTE: The AC power cable is grounded to the threaded grounding hole on the back panel of the enclosure between the cord grip and the power supply connections rather than using Pin 3. This is a UL requirement.

Pin	Description	Wire Color	Cable Part No.
1	120 VAC (Line In)	Brown or Black	180842
2	AC Neutral	Blue or White	
3	Ground	N/C or Green/Yellow	–
4	DC Out (-V)	Black	199514
5	DC Out (+V)	Red	

Table 2-3. AC Power Supply Pin Assignments



NOTE: Colors may vary depending on manufacturer of AC power cable. Utilize testing procedures to ensure proper installation.

2.4.5 Speed Sensor

A belt conveyor scale must be equipped with an encoder (speed sensor) that accurately senses the belt speed and travel distance when the belt is empty or loaded. The J13 connector provides the pulse input from the speed sensor to the 882D. To attach the cable from the encoder, route the cable to the J13 connector (Figure 2-9 on page 18). The connector for the cable is included in the parts kit. Wire the cable to connector as shown in Figure 2-4. Pins 4, 5 and 6 are the top level of the connector and make up the primary pulse input channel (Input 1). Pins 1, 2 and 3 are the bottom level of the connector and make up the secondary pulse input channel (Input 2).

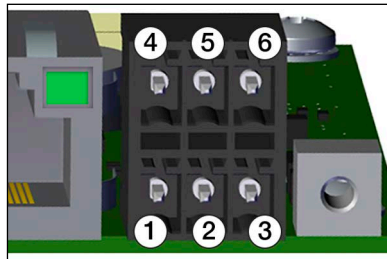

Connector	Pin	Signal
J13	1	+12V, 100 mA max
	2	Ground
	3	Pulse Input #2
	4	+12V, 100 mA max
	5	Ground
	6	Pulse Input #1

Table 2-4. J13 Pin Assignments (Speed Sensor)

2.4.6 Digital I/O

The Digital I/O Port, J2 connector (Figure 2-9 on page 18) is intended to be connected to both digital inputs and outputs.

Digital inputs can be set to provide many functions, including most keypad functions except MENU. Digital inputs are active low (0 VDC) and inactive high (5 VDC). Use the Digital I/O menu to configure the digital inputs.

Digital outputs are used to control relays that drive other equipment. Outputs are designed to sink, rather than source, switching current. Each output is an open collector circuit, capable of sinking 20 mA when active. Digital outputs are active when low or at 0 VDC, with reference to the 5 VDC supply.

Use the Digital I/O menu to set the function of the Digital I/O pins to OUTPUT and then use the Setpoints menu to configure the digital outputs. Table 2-5 shows the pin assignments for the J2 connector.

Connector	Pin	Signal
J2	1	5VDC, 500 mA max
	2	GND
	3	DIO1
	4	DIO2
	5	DIO3
	6	DIO4

Table 2-5. J2 Pin Assignments (Digital I/O)

2.4.7 Serial Communications – Port 1 (COM)

The J3 connector (Figure 2-9 on page 18) is intended to provide a connection point for the RS-232 or the two-wire RS-485/RS-422 serial communications. Table 2-6 shows the pin assignments for the J3 connector.

Pin	RS-232	RS-485/RS-422
1	GND	GND
2	RX	B
3	TX	A

Table 2-6. J3 Pin Assignments (Port 1 Serial Communications)



NOTE: For RS-232, all four switches on SW3 (Figure 2-9 on page 18) must be in the OFF position. For RS-485/RS-422, all four switches on SW3 must be in the ON position.

2.4.8 USB Device Communications – Port 2 (USBCOM)

The USB Device Port, J4 micro USB connector (Figure 2-9 on page 18), is intended to be connected to a PC only. It appears as a Virtual COM Port and is assigned a “COMx” designation. Applications communicate through the port like a standard RS-232 communications port.

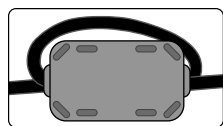

A ferrite from the parts kit must be applied to the USB cable within 1" of the cord grip. The cable must be sent through the ferrite twice.

The driver must be installed on the PC before the USB Device Port can be used. With the PC and 882D powered on, connect a USB cable from the PC to the micro USB connector (J4) on the 882D. The PC will recognize that a device has been connected, and attempt to install the driver needed to make it work. The driver can also be downloaded from the [Rice Lake website](#).



NOTE: If using Windows 7 or later and the PC is connected to the Internet, the operating system may be able to install the drivers without any interaction.

When the individual drivers are installed, a new COM Port designation is assigned for each physical USB port the 882D is connected to on the PC.

For example, if the PC has two physical RS-232 COM Ports, they most likely are designated COM1 and COM2. When connecting the 882D to a USB port on the PC, it is assigned the next available port designation, or in this case, COM3. When plugging into the same physical USB port on the PC, the port designation is again COM3. If plugging into another physical USB port on the PC, it is assigned the next available designation, in this case COM4.

After the drivers are installed, use Windows Device Manager to determine the COM Port designation that was assigned to the USB port. Or open the application that is to be used with the 882D, such as Revolution®, to see which ports are available.

Configuration of the USB Device Port is done in the USBCOM sub-menu under PORTS in configuration mode.

The port can be configured as either a demand port for EDP commands and printing, or as a data streaming port. Other settings include the termination character(s), echoes, responses, the end-of-line delay and whether or not the 882D displays a 'print' message when a print format sends data out the port.



NOTE: *If a computer application has an open communications connection through the USB Device Port and the physical cable connection is interrupted, a soft reset must be performed on the 882D or the power must be cycled to the 882D; the connection in the computer application must be disconnected and then reconnected before it will continue to communicate with the 882D.*

For the USB Device Port, it does not matter what the settings are for Baud, Data Bits, Parity and Stop Bits in the computer software. The port communicates in the same way regardless of these settings.

This port is not a host port and is not intended to be connected to other devices such as keyboards, memory sticks or printers.

2.5 USB Host

The 882D will be capable of hosting a USB device through the J5, Type A USB connection, in a future release.

2.6 Ethernet Communications

The 882D features Ethernet TCP/IP 10Base-T/100Base-TX communication using a standard RJ45 connector, J6 (Figure 2-9 on page 18). It can support two simultaneous connections, one as a server, the other as a client.

Through an Ethernet network, software applications can communicate with the 882D using the EDP command set (Section 7.0 on page 57), or data can be streamed continuously from the 882D, or printed on demand.

The Ethernet port supports both DHCP and manual configuration of settings such as the IP and netmask. In addition, the TCP Port number, Primary and Secondary DNS, and the Default Gateway can be configured using the Ethernet sub-menu of the Ports setup menu. For more information on configuring the Ethernet port see Section 4.6.3.2 on page 38.

Physical connection to the 882D Ethernet port can be made directly from a PC to the 882D (AdHoc Network), or through a network router or switch. The port supports auto-sensing MDI/MDIX cable configuration, so either straight-through or crossover cables can be used.

The RJ45 Ethernet jack on the 882D CPU board houses two LEDs to indicate the status and speed of the connection.

Yellow LED (left) indicates the status of the connection:

- Off for no link
- On for a link
- Blinking if there is activity

Green LED (right) is:

- Off for a 10Base-T connection
- On for a 100Base-TX connection

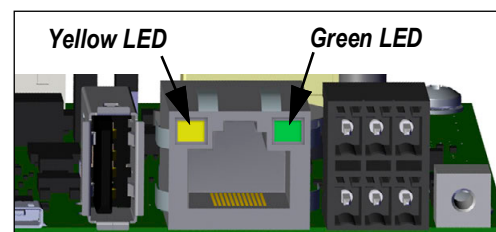

Figure 2-8. RJ45 Ethernet Jack



IMPORTANT: *The Ethernet port is not intended for use on Telecom Networks Circuits that are subject to lightning or power faults. For information on using the Ethernet port see Section 9.1 on page 80.*

2.7 CPU Board

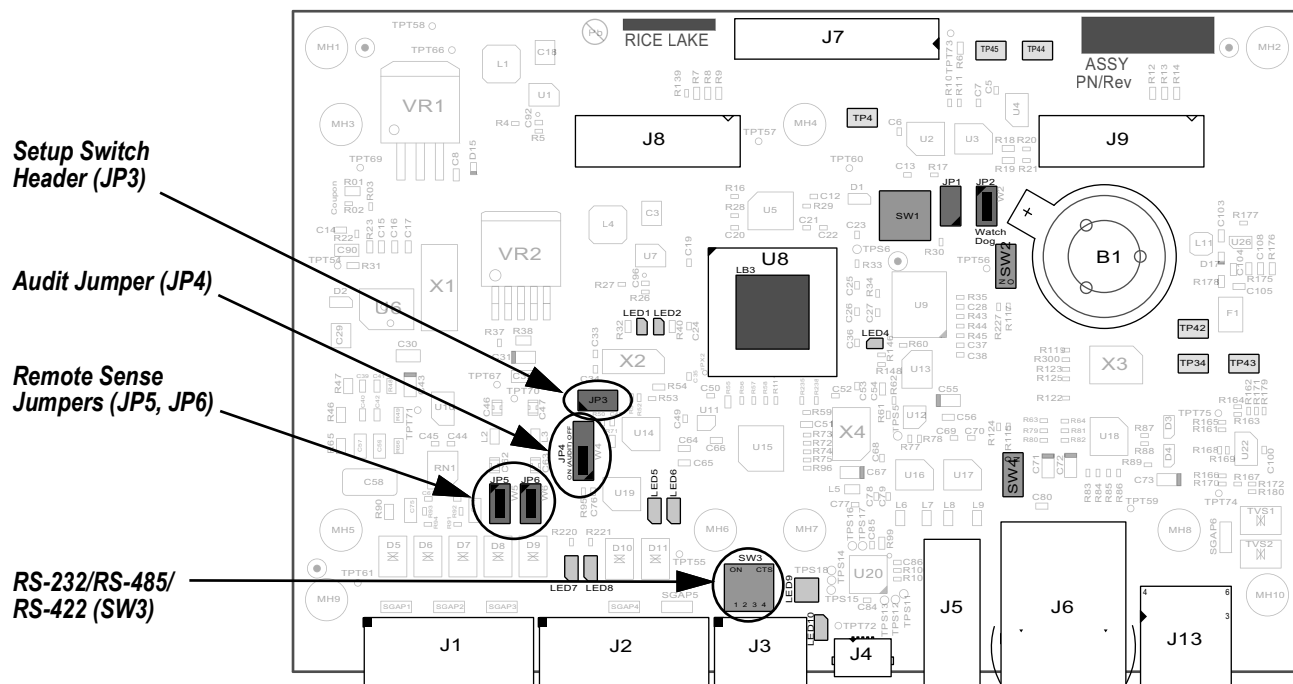

Figure 2-9. 882D CPU Board

Connectors

- Load Cell (J1)
- DIO (J2)
- COMM 1 (J3)
- USB Micro Device (J4)
- USB Host (J5)
- Ethernet TCP/IP (J6)
- Power Board (J7)
- OPT#1 (J8) and OPT#2 (J9)
- Pulse Input (J13)

The COMM 1 port supports RS-232 or two-wire RS-485/RS-422 communications; selectable with switch SW3. The port is configured using the COM menu under Ports. See [Section 4.6.3.1 on page 37](#).

2.8 Audit Trail

The 882D supports a Type 3 Audit Trail. The Audit Trail records all of the changes to Legal for Trade parameters.

During installation, determine if access will be allowed to the configuration and calibration functions through the front panel. The position of the 3-pin Audit Trail jumper (JP4) on the CPU board controls if access is allowed or not.

- If the jumper is set to ON, the Setup Menu will be visible, making calibration and configuration accessible through the front keypad.
- If set to OFF, the Setup Menu will not be visible, making calibration and configuration accessible only by pressing the setup switch.

The audit trail event logger operates in either position of the audit jumper.

2.9 Backplate Attachment

Once cabling is complete, reattach the backplate ground wire to the backplate. Position the backplate over the enclosure and install the eight backplate nuts. Use the torque pattern shown in [Figure 2-10](#) to prevent distorting the backplate gasket. Torque nuts to 15 in-lb (1.7 N-m).

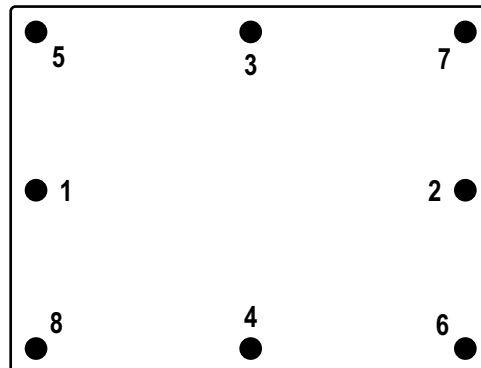

Figure 2-10. Torque Pattern

2.9.1 Sealing

In certain applications, it may be necessary to seal the 882D to restrict access from the setup switch.

882D Sealing

1. Remove the lower left and lower center nuts securing the backplate. Replace with two drilled hex standoffs found in the parts kit.
2. Place the sealing wire through the drilled hex standoffs on the backplate, then through the fillister head screw at the bottom of the enclosure, as shown in [Figure 2-11](#).
3. Seal the wire to secure.

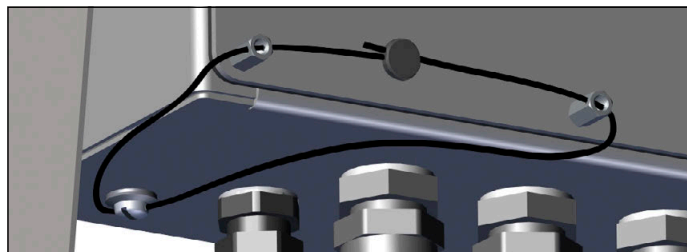

Figure 2-11. Sealing the 882D

2.10 Parts Kits Components

Parts Kit, AC Power (PN 180851)		
Part No	Description	Qty
153873	Connector, 3 Pos Screw Terminal	1
153883	Connector, 6 Pos Screw Terminal	3
15631	Cable Tie, 3in Nylon	6
16159	Bag, Plastic 3 x 5	1
180826	Nut, M4 x 0.7 x 10mm	10
180852	Standoff, M4 x 0.7 x 10mm	2
181694	Connector, 3 x 2 Pos Spring Term	1
184278	Ferrite Core, Snap On	1
186198	Label, Capacity Belt Scale	1
19538	Post Plug, Slotted Black	1
42149	Bumper, Rubber Grommet	4
53075	Clamp, Ground Cable Shield	4
67550	Clamp, Ground Cable Shield	2

Parts Kit, DC Power (PN 187498)		
Part No	Description	Qty
153873	Connector, 3 Pos Screw Terminal	1
153883	Connector, 6 Pos Screw Terminal	3
15631	Cable Tie, 3in Nylon	6
15694	Connector, Eye Crimp No 8	1
15888	Terminal Block, 3 Position	1
16159	Bag, Plastic 3 x 5	1
180826	Nut, M4 x 0.7 x 10mm	10
180852	Standoff, M4 x 0.7 x 10mm	2
181694	Connector, 3 x 2 Pos Spring Term	1
184278	Ferrite Core, Snap On	2
186198	Label, Capacity Belt Scale	1
19538	Post Plug, Slotted Black	1
42149	Bumper, Rubber Grommet	4
53075	Clamp, Ground Cable Shield	4
67550	Clamp, Ground Cable Shield	2

Table 2-7. Parts Kits Components

2.11 Replacement Parts

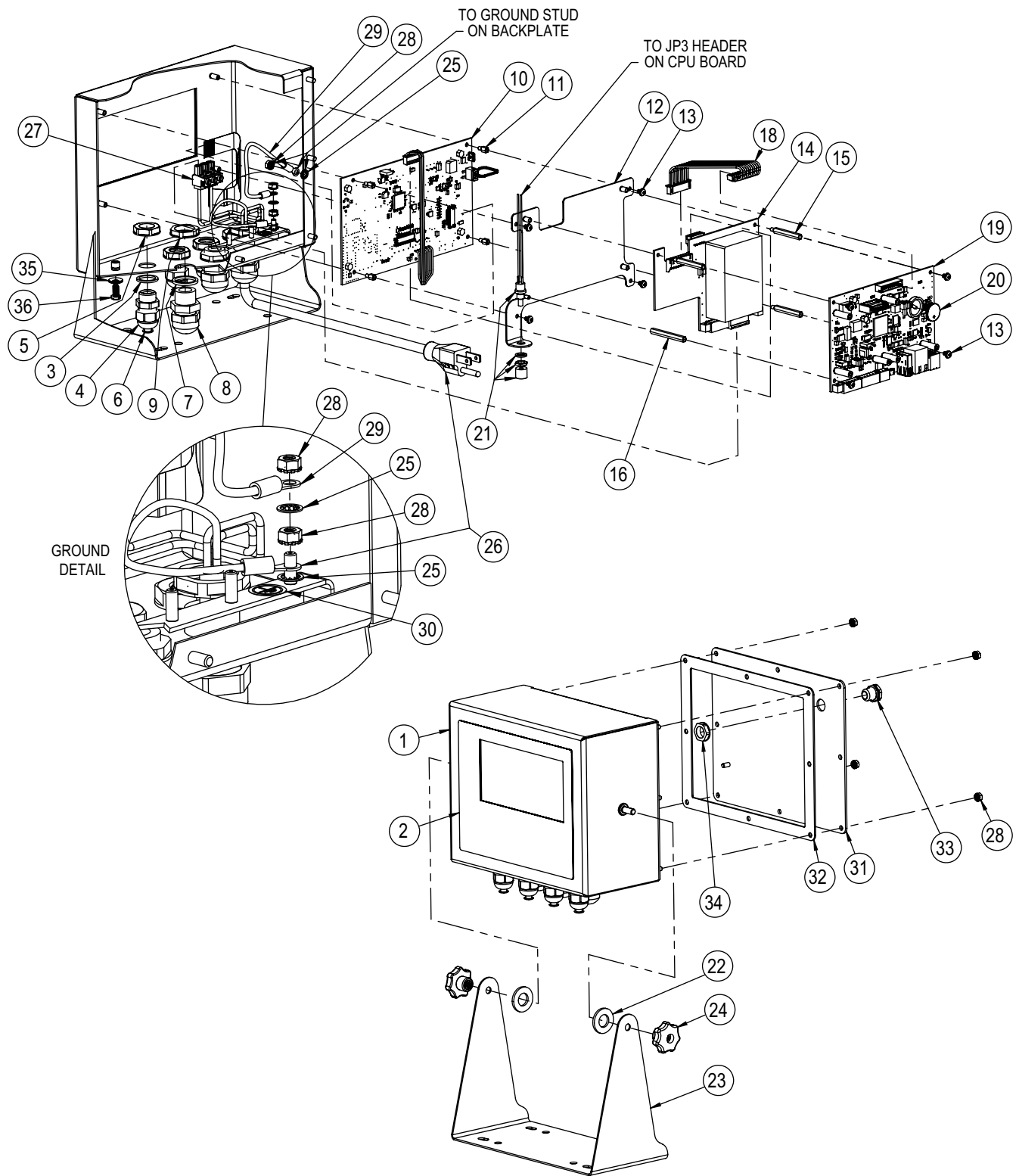

Item No.	Part No.	Description	Qty
1	177305	Enclosure, 882D Belt Scale	1
2	175214	Overlay, 882D Membrane Switch with Numeric Keys	1
3	30375	Seal Ring, PG9 Nylon	4
4	15626	Cord Grip, PG9 Plastic	4
5	15627	Lock Nut, PG9 Plastic	4
6	19538	Post, Slotted Black Seal 1/4 x 1, Cord Grip - Post Only	4
7	68599	Seal Ring, PG-11	3
8	68600	Cord Grip, PG11	3
9	68601	Nut, PG11 Black Nylon	3
10	195688	Display Board Replacement	1
11	180821	Standoff, M3 x 0.5 x 5 mm Hex Male-Fem SS	4
12	177306	Adapter Plate, Power Supply 882D	1
13	199474	Screw, M3 x 0.5 x 5 mm SEMS Phillips Head Zinc Finish Steel External Tooth Washer	8
14	175603	Board Assy, 880/882 Power Supply 115-230 VAC 5.5 Inch Blue Color (AC & EURO Only)	1
	175604	Board Assy, 880/882 Power Supply 9-36 VDC 5.5 Inch Blue Color (DC Only)	1
15	180822	Standoff, M3 x 0.5 x 31 mm Hex Male-Fem SS	3
16	180823	Standoff, M3 x 0.5 x 40 mm Hex Fem-Fem SS	1
18	154762	Cable Assy, 10 Pos CPU to Power Supply 880 Controller	1
19	195681	CPU Board Replacement with Battery	1
20	69291	Battery, 3V Coin Lithium, 16mm Diameter, 125(mAh)	1
21	44845	Setup Switch Assy	1
22	103988	Washer, Nylon .515-.52	2
23	163751	Tilt Stand, 880 Desktop	1
24	180825	Knob, M6 x 1 Threaded Thru 32 mm Dia 7-Lobe Nylon ZN-PLTD Steel	2
25	15134	Washer, Lock NO 8 Type A Internal Tooth Steel Zinc Plated	3
26	180842	Power Cord Assy, 882D Belt Scale Nema 5-15 (AC Only)	1
	180850	Power Cord Assy, 882D Belt Scale Europe CEE7/7 (EURO Only)	1
27	152334	Connector, 3 Pos Screw Terminal (AC & EURO Only)	1
28	180826	Nut, Kep M4 x 0.7 External Tooth Lock Washer 18-8 SST	7
29	15601	Wire, Ground 6 in w/NO 8 Eye Connector	1
30	16892	Label, Ground Protective Earth Adhesive IEC 60417-5019	1
31	180827	Backplate, 882D Universal Belt Scale	1
32	163768	Gasket	1
33	88733	Vent, Breather Sealed Gortex Membrane Black Plastic	1
34	88734	Nut, Breather Vent M12 x 1 Thread	1
35	46381	#10, Bonded Sealing Washer, 18-8 Stainless Steel	1
36	180861	Screw, Mach M5 x 0.8 x 10mm	1

Table 2-8. Replacement Parts List

3.0 Operation

The front panel consists of a large back-lit LCD display, six primary scale functions keys, numeric keys and four function keys.

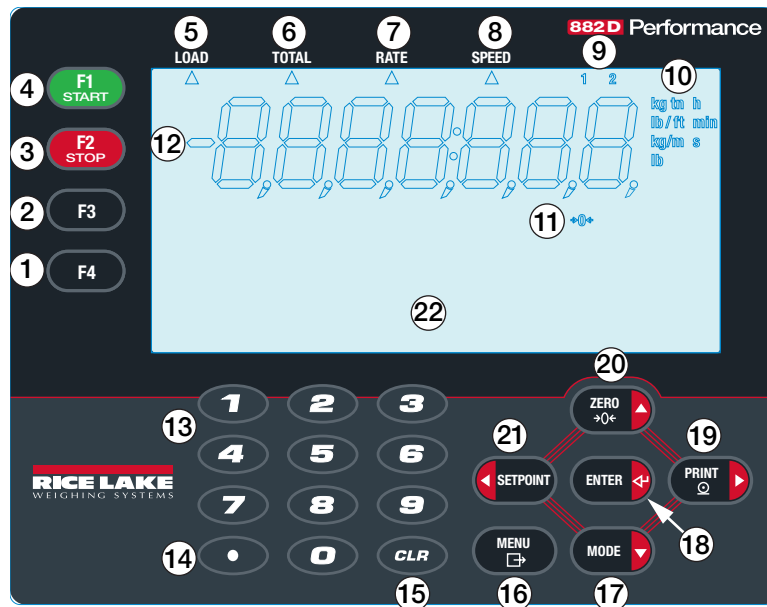

Figure 3-1. 882D Front Panel

Item No.	Description
1	F4 key – does not have a pre-defined use but can be monitored by an iRite application
2	F3 key – does not have a pre-defined use but can be monitored by an iRite application
3	F2/Stop key – used for batching and calibration
4	F1/Start key – used for batching and calibration
5	Load – displays when arrow annunciator is illuminated
6	Total – displays when arrow annunciator is illuminated
7	Rate – displays when arrow annunciator is illuminated
8	Speed – displays when arrow annunciator is illuminated
9	Totalizer 1-2 – the corresponding totalizer displays when the 1 or 2 annunciator is illuminated; the master totalizer displays when neither the 1 or 2 annunciator is illuminated
10	Units – metric units: metric tons, kilograms, meters; imperial units: short tons, pounds, feet; time units: hours, minutes, seconds
11	Center-of-Zero – displays when the Rate is within the Zero Band; the Zero Band is defined as a percentage of the Max Capacity (Max Rate) and is configurable in the configuration settings
12	Numeric display – seven digit display using 7-segment digits, a dash, a period (dot) and comma
13	Numeric keys – 0-9, used to enter a numeric value for a parameter or prompt
14	Decimal point key – inserts a decimal point
15	Clear key – resets totalizer 1 or 2 when displayed in weigh mode; deletes the currently selected character when editing a parameter or prompt
16	Menu key – accesses/exits the menu structure; also functions as a “cancel” key when editing a parameter value
17	Mode key – switches the weigh mode numeric display area between load, totalizer 1, totalizer 2, totalizer master, rate and speed; also used as the down key to navigate menus or to edit a value
18	Enter key – accepts entry at a prompt or when editing value
19	Print key – sends print data to a communications port when in weigh mode; also used as the right key to navigate menus or to edit a value
20	Zero key – places 882D into dynamic zero calibration when in weigh mode; also used as the up key to navigate menus or to edit a value
21	Setpoint key – navigates to top level setpoint menu at first defined setpoint; also used as the left key to navigate menus or to edit a value
22	Messaging area – 121 x 24 dot-matrix display, has three lines of text with up to 20 characters per line

Table 3-1. Front Panel Keys and Annunciator Descriptions

3.1 Operating Modes

The three modes of operation for the 882D are described in the following sections.

Weigh Mode

In this mode, the 882D displays weight per conveyor belt distance, the amount of weight totalized, material flow rate, conveyor belt speed and annunciators to indicate status.

Setup Mode

Most of the procedures described in this manual, including configuration and calibration, require the 882D to be in setup mode.

To enter setup mode, remove the fillister head screw from the bottom of the enclosure. Insert a non-conductive tool into the access hole and press the setup switch once, allowing access to the *Scale* menu ([Section 4.0 on page 27](#)).

The 882D also has an Audit Trail that can track changes to configuration and calibration, allowing the setup switch to be bypassed with Jumper J4 on the CPU board. If Audit Trail is enabled, configuration mode can then be accessed through the user setup mode.

User Mode

User mode (accessed by pressing the *Menu* key) is used to:

- View/print the audit trail
- Enter setup mode (if audit trail is enabled)
- Clear the master totalizer
- Set the time and date
- View the current pulse input rate

3.2 Weigh Mode Selection

Press  to switch the numeric display area between load, totalizer 1, totalizer 2, master totalizer, rate and speed.

Load, totalizer, rate and speed values are up to 7 digits in length. Depending on the value and which units are configured (METRIC or IMPERIAL), the units identifier will be lb, kg, tn, t, ft/min, lb/ft, m/s, kg/m.

Load – the amount of material present on a section of the belt, e.g. pounds per foot

Totalizer 1 & 2 – totalizers that hold accumulated value of material that has passed over the weigh frame since their last reset









Master Totalizer – is the accumulated value of material that has passed over the weigh frame since its last reset

Rate – the rate of flow of material, e.g. tons per hour

Speed – the speed at which the belt is moving, e.g. feet per second; the belt speed is the actual measured value using a speed sensor or it can be a fixed value configured manually in the configuration settings

3.3 Audit Trail Information

The audit trail report can be printed to a specified port through the Audit menu.

1. Press . *Audit* is displayed.
2. Press . *LRV* is displayed.
3. Press . *Audit Print Port* is displayed.
4. Press . The current Audit Print Port selection is displayed.
5. Press  to scroll through port options to transmit the audit report. See [Table 4-2 on page 29](#) for available options.
6. Press  to make selection. *Print Audit Trail* is displayed.
7. Press  to print the Audit Trail report to the port specified.
8. Press  to return to the weigh mode.

3.4 Totalizers

The 882D maintains three totalizers:

- Totalizer 1
- Totalizer 2
- Master totalizer



NOTE: When a totalizer is displayed there is an arrow pointing to **TOTAL** (a) on the overlay with a number annunciator (b) in the upper right hand side of the display. There is no number annunciator for the master total.

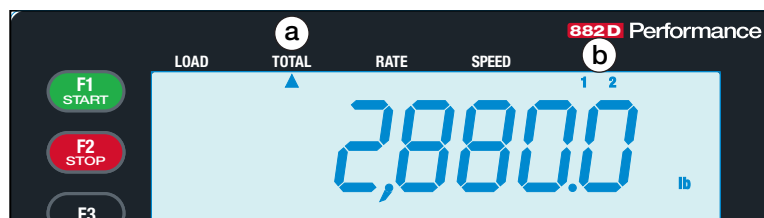

Figure 3-2. Totalizer Annunciators



3.4.1 Totalizer 1 and 2

Two totalizers are provided so that different scenarios can be tracked.

Example: one could be a shift total and the other could be a daily total.

Clearing Totalizer 1 and 2

To clear totalizer 1 or 2 with the front panel, it must first be displayed in the weigh mode.

1. Press  repeatedly until the desired totalizer is shown.
2. Press . *Press Enter To Clear* is displayed.
3. Press  clears the totalizer. *CLEAR* briefly displays.



NOTE: Press any other key to cancel.

EDP commands *RT1* and *RT2* immediately clear the respective totalizer. See [Section 7.2 on page 60](#).









Triggering a *CLRTOT1* or *CLRTOT2* digital input immediately clears the respective totalizer. See [Section 4.6.6 on page 42](#).

3.4.2 Master Totalizer

The master totalizer is a total of all the material that has gone across the scale.

Master Totalizer Reset

The Master Total can be cleared through the Test menu. The ability to reset the master totalizer can be limited by a password protecting the User menu. See [Section 4.6.2.2 on page 36](#).

1. Press . *Audit* is displayed.
2. Press  twice. *Test* is displayed.
3. Press . *Pulse Input* is displayed.
4. Press . *Master Total Reset* is displayed.
5. Press . *NO* is displayed.
6. Press . *YES* is displayed.
7. Press . *RESET* briefly displays.
8. Press  to return to the weigh mode.



NOTE: *The 882D clears all of the totalizers at power up if the non-volatile memory appears to be corrupt.*

4.0 Configuration

Several parameters can be accessed and set by pressing .



NOTE: All weight related parameters must be configured prior to calibrating the unit.

4.1 Setup Switch Configuration Access

In order to configure the 882D, it must be placed in configuration mode with the setup switch or accessed through the User menu (Section 4.2). The setup switch is accessed through a small hole on the bottom of the enclosure. Insert a non-conductive tool into the access hole to press the setup switch.



IMPORTANT: Use caution when inserting the non-conductive tool into the enclosure. Insert the tool about 3/4 inch, until the switch is engaged. Do not use excessive force which could damage the switch.

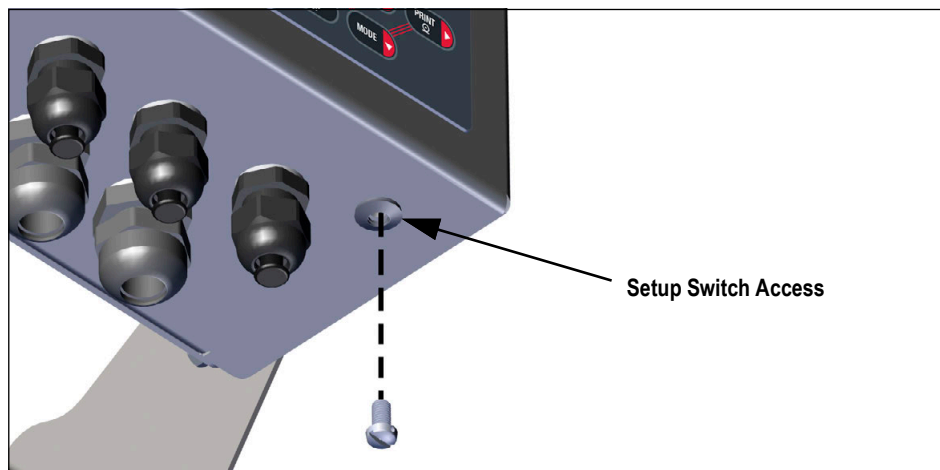







Figure 4-1. Setup Switch Access

When the 882D is placed in configuration mode, the Setup menu is accessed and *Scale* displays. See Section 4.6 on page 29 for a detailed description of this menu. Torque the setup switch screw to 15 in-lb (1.7 N-m) when reinserting.

4.2 User Menu Configuration Access

The 882D supports an Audit Trail jumper. If the jumper is set to ON, the Setup Menu is visible, making calibration and configuration accessible through the front keypad. If set to OFF, the Setup Menu is not visible, making calibration and configuration accessible only by pressing the setup switch.







If the audit trail jumper (JP4) is set to ON, configuration mode may be accessed by pressing .

1. Press . *Audit* is displayed.
2. Press . *Setup* is displayed.
3. Press . *Scale* is displayed. See Section 4.6.1 on page 30 for the breakdown of the *Scale* menu.
4. Press . *Configuration* is displayed.
 - Press  again to access the *Configuration* parameters.
 - Or press  to move to the *Calibration* menu.











When configuration is complete, press  to return to the weigh mode.

4.3 General Navigation

The front panel keys are used to navigate through the menus.

-  and  move left and right (horizontally) in a menu level
-  and  move up and down (vertically) to different menu levels
-  to select parameter values within the menus or to enter a submenu
-  to enter/exit the menus
- Use the keypad to enter a value and press  to accept the value.

When editing an alphanumeric string:

1. Press  and  to move to a character.
2. Press  to select a desired character to edit.
3. Press  and  to scroll through character options.
4. Press  or  to accept character.
5. Press  to create a space.
6. Press  twice or  to delete a character.
7. Repeat steps for all necessary characters.
8. Press  to save string and return to the level above.

4.4 User Menu



Figure 4-2. User Menu

Menu	Description
Audit	Displays the legally relevant (LR) firmware version, and allows access to view/print audit trail information; See Section 4.5
Setup	Used to enter setup mode if audit trail is enabled; See Section 4.6
Test	View the pulse input, reset the master total; See Section 4.7 on page 45
Time & Date	View and change time and date; See Section 4.8 on page 45

Table 4-1. User Menu Parameters

4.5 Audit Menu

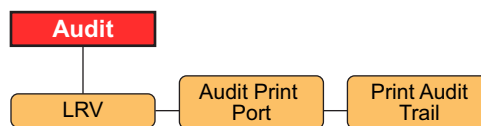

Figure 4-3. Audit Menu

Parameter	Description
LRV	Legally relevant firmware version
Audit Print Port	Sets the port that an audit report is transmitted on; <i>Settings:</i> COM (default) – RS-232 and RS-485 Communications Port USBCOM – USB Device Port ETH-S – Ethernet Server Port ETH-C – Ethernet Client Port OFF – No printing port selected
Print Audit Trail	Output print to the port specified by the <i>Audit Print Port</i> parameter

Table 4-2. Audit Menu Parameters

4.6 Setup Menu

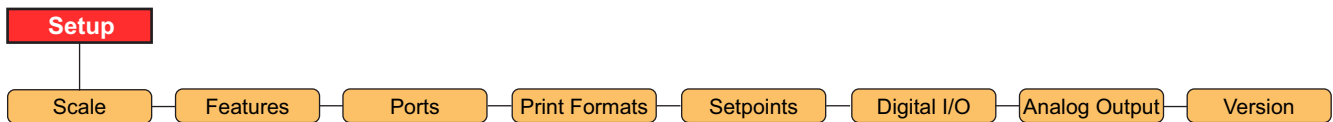

Figure 4-4. Setup Menu

Menu	Description
Scale	Set configuration and calibration of the scale; See Figure 4-5 on page 30
Features	Set miscellaneous system attributes; See Figure 4-11 on page 35
Ports	Configure communication ports; See Figure 4-14 on page 37
Print Formats	Set print format 1-4 to be used; See Figure 4-17 on page 39
Setpoints	Configure setpoints and batching mode; See Figure 4-18 on page 40
Digital I/O	Assign digital input/output functions; See Figure 4-19 on page 42
Analog Out	Configure the analog output module (if installed); See Figure 4-20 on page 43
Version	View the installed firmware version number or reset to factory settings; See Figure 4-21 on page 44

Table 4-3. Setup Menu Parameters

4.6.1 Setup – Scale Menu

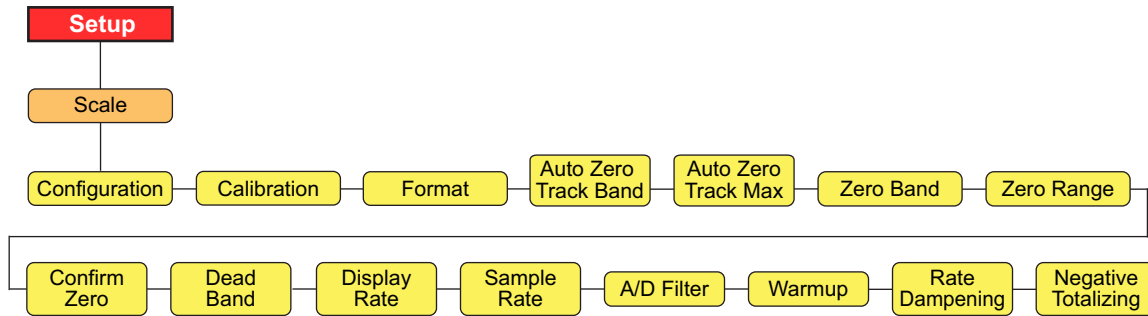

Figure 4-5. Setup – Scale Menu

Parameter	Description
Configuration	For Configuration menu see Figure 4-6 on page 31
Calibration	For Calibration menu see Figure 4-7 on page 32
Format	For Format menu see Figure 4-8 on page 33
Auto Zero Track Band	Automatically zeros scale when within range specified, if Rate is within the Zero Range; Specify zero tracking band as a percentage of Max Capacity (Rate); maximum legal value depends on local regulations; <i>Enter value: 0.0-100.0, 0.0 (default)</i>
Auto Zero Track Max	This is the maximum amount as a percentage of Max Capacity (Rate) that can be auto zeroed; <i>Enter value: 0.0-100.0, 0.0 (default)</i>
Zero Band	This is the range that is used to determine whether the weight is zero; Zero band represents a percentage of Max Capacity (Rate); When weight is within the zero band, the center of zero annunciator will be displayed; Maximum legal value depends on local regulations; <i>Enter value: 0.0-100.0, 0.0 (default)</i>
Zero Range	This is the total amount that can be zeroed off - either manually or summed with Auto Zero; Zero range represents a percentage of Max Capacity (Rate); A value of 0.0 prevents any zeroing; Maximum legal value depends on local regulations; <i>Enter value: 0.0-100.0, 0.0 (default)</i> <i>Example: A value of 1.9 represents $\pm 1.9\%$ around the calibrated zero point, for a total range of 3.8%</i>
Confirm Zero	Prompts to confirm a zero operation. Applies to front panel zero key or digital input; <i>Settings: ON (default), OFF</i>
Dead Band	882D does not totalize the amount if the rate is within the dead band value; The flow rate is set to zero within the dead band; Dead band represents a percentage of Max Capacity (Rate); <i>Enter value: 0.0-100.0, 0.0 (default)</i>
Display Rate	Specifies the display update rate, number of 100-millisecond intervals between updates; <i>Enter value: 1-80, 1 Hz (default)</i>
Sample Rate	Selects measurement rate, in samples per second, of the analog-to-digital converter; <i>Settings: 30HZ (default), 60HZ, 120HZ, 7.5HZ, 15HZ</i>
A/D Filter	For A/D Filter menu see Figure 4-9 on page 34
Warmup	The warmup timeout is started once speed is detected at power up; If speed drops to 0 or 882D enters setup mode, the warmup timer stops; The warmup timer will restart once speed is above 0 and 882D is in weigh mode; The parameter for warmup represents minutes, a setting of 0.0 will disable warmup; <i>Enter value: 0.0-60.0, 0.0 (default)</i> If the Rate or Load is being displayed while warmup is active: Message area will show "Warm Up" No annunciators will be displayed Dashes will fill numeric area Modes other than Rate or Load will display normally while warmup is active.
Rate Dampening	For Rate Dampening menu see Figure 4-10 on page 34
Negative Totalizing	Specifies whether to allow values to be totalized when load value is negative, causing value to be subtracted from totalizers; <i>Settings: YES (default), NO</i>

Table 4-4. Setup – Scale Menu Parameters



NOTE: The 882D goes directly to the Scale menu when the setup switch is pressed ([Section 4.1 on page 27](#)).

4.6.1.1 Scale – Configuration Menu

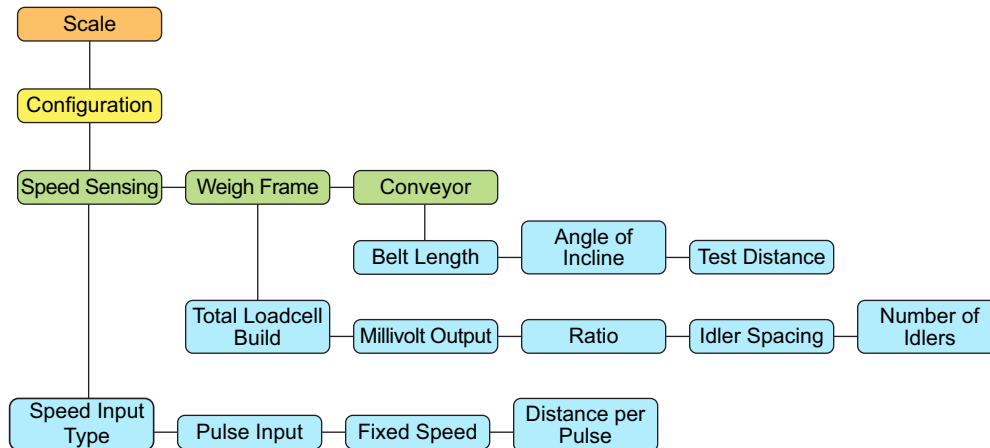

Figure 4-6. Scale – Configuration Menu

Parameter	Setting	Description
Speed Sensing	--	Settings related to the belt speed sensor
	Speed Input Type	Description - Configures how the system determines the belt speed. <i>Settings:</i> <i>PULSE (default) - Determines belt speed from pulses of a connected speed sensor</i> <i>FIXED - A pre-determined belt speed is entered into the 882D during configuration</i> <i>PLC - A connected PLC provides the belt speed (ft/min, m/s) by setting the value of Setpoint 20</i> NOTE: When using either a Fixed belt speed or a PLC provided belt speed, there must also be digital I/O configured and enabled as BELTRUNNING or the belt speed will be considered 0 (zero) (see Section 4.6.6 on page 42).
	Pulse Input	Specifies the pulse input scheme used for speed determination and error detections; <i>Settings:</i> <i>SINGLE (default) – A single sensor going only to pulse input #1</i> <i>DUAL – Two sensors each going to an individual pulse input</i> <i>REDUNDANT – A single sensor going to both of the pulse inputs</i>
	Fixed Speed	Specifies a fixed belt speed for the 882D (ft/min, m/s); <i>Enter value: 0.0-9999.0, 0.0 (default)</i>
	Distance per Pulse	Distance represented by each pulse from a speed sensor (ft, m); <i>Enter value: 0.0-99.0, 1.0 (default)</i>
Weigh Frame	--	Settings related to the weigh frame
	Total Loadcell Build	Defines the total capacity of the all load cells in system (lb, kg); <i>Enter value: 1.0-99999.0, 500.0 (default)</i> <i>Example: if there are eight load cells and each has a rated capacity of 100, multiply 100 by 8; 800 would be the total capacity</i>
	Millivolt Output	Average mv/v rating of all load cells in the system; This is used for the theoretical calibration; Value must be greater than 0; <i>Enter value: 0.1-4.5, 3.0 (default)</i>
	Ratio	The lever ratio for a pivoted weigh frame; The total loadcell build is multiplied by the configured ratio to determine a working total loadcell build value; <i>Enter value: 0.0-9.999, 1.0 (default)</i>
	Idler Spacing	Spacing between the idlers used to determine weighing surface of belt scale (in, m); <i>Enter value: 0.01-9999.0, 48.0 (default)</i>
	Number of Idlers	Number of idlers being used; <i>Enter value: 1-4, 1 (default)</i>
Conveyor	--	Settings related to the conveyor being used
	Belt Length	The total length of the conveyor belt (ft, m); <i>Enter value: 1.0-99999.0, 500.0 (default)</i>
	Angle of Incline	The angle of the conveyor measured in degrees; used when 882D is used with weigh frames containing one or two load cells; <i>Enter value: 0.0-89.0, 0.0 (default)</i>

Table 4-5. Scale – Configuration Menu Parameters

4.6.1.2 Scale – Calibration Menu

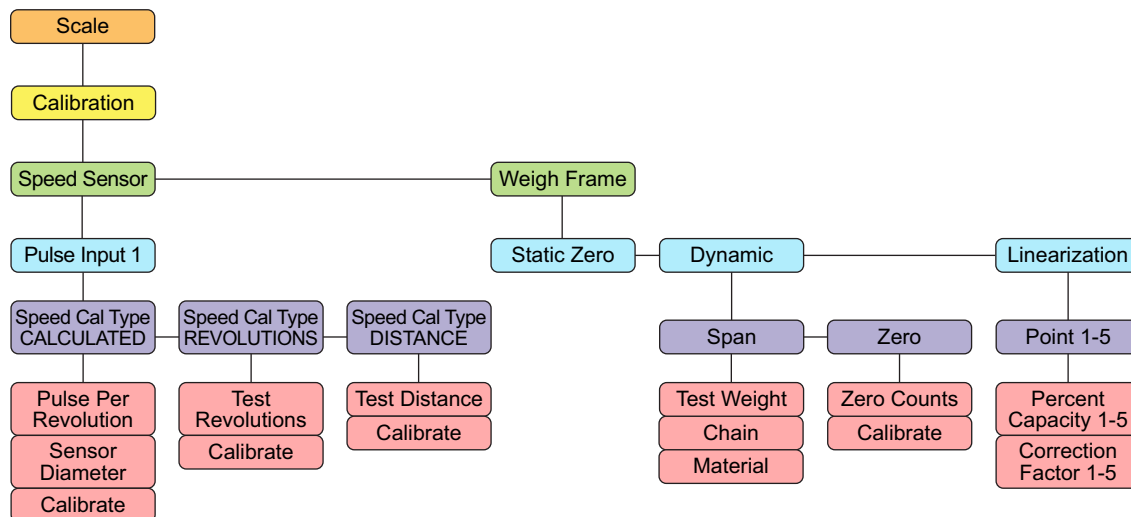

Figure 4-7. Scale – Calibration Menu

Speed Sensor Parameters

Parameter	Description
Speed Cal Type CALCULATED	Belt speed is calculated from known parameters of the speed sensor; see Section 5.1.1 on page 46 ; Sub-parameters: Pulse Per Revolution – Number of pulses output from the speed sensor per speed sensor revolution Sensor Diameter – The diameter of the speed sensor (in/mm) Calibrate – Initiates a calculated speed calibration
Speed Cal Type REVOLUTIONS	Belt speed is determined by measuring the number of complete revolutions; see Section 5.1.2 on page 47 ; Sub-parameters: Test Revolutions – User provided number of revolutions that the belt made during a speed calibration Calibrate – Initiates a revolutions speed calibration
Speed Cal Type DISTANCE	Belt speed is determined by measuring the speed sensor output over a set distance; see Section 5.1.3 on page 49 ; Sub-parameters: Test Distance – User provided distance that the belt travels during a speed calibration (ft/m) Calibrate – Initiates a distance speed calibration

Table 4-6. Scale – Calibration – Speed Sensor Menu Parameters

Weigh Frame Parameters

Parameter	Description
Static Zero	A dead load calibration with the belt not moving; see Section 5.2.1 on page 50
Dynamic Span	There are three dynamic span calibration options; see Section 5.2.2 on page 50 ; Options: Test Weight – Span calibration based on belt length defined by number of revolutions and static test weight; see Section 5.2.2.1 on page 50 ; Sub-parameters: Test Weight Value – The amount of test weight used Calibrate – Initiates a test weight span calibration Chain – Span calibration based on belt length defined by number of revolutions and static chain weight; see Section 5.2.2.1 on page 50 ; Sub-parameters: Chain Weight – The weight/length of a chain used (ex. A chain weight value of 100 equals 100 kg/meter, if in metric) Calibrate – Initiates a chain span calibration Material – Span calibration based on a known amount of material; Section 5.2.2.2 on page 51 ; Sub-parameters: Material Weight – The known weight amount of the material Calibrate – Initiates a material span calibration
Dynamic Zero	A dead load calibration with the belt moving; see Section 5.2.3 on page 52 ; Sub-parameters: Zero Counts – Raw count value zero (deadload); can be set manually or through calibration Calibrate – Initiates a dynamic zero calibration
Linearization Point 1-5	Allows up to five correction Factor ranges to be configured as a percent of Max Capacity; Section 5.2.4 on page 53 ; Sub-parameters: Percent Capacity 1-5 – Percentage of Max Capacity; for which the correction Factor for this linear point will be applied; Enter value: 0.0-100.0, 0.0 (default) Correction Factor 1-5 – Correction Factor for the corresponding linear point; Enter value: 0.0-1000.0, 100.0 (default)

Table 4-7. Scale – Calibration – Weigh Frame Menu Parameters

4.6.1.3 Scale – Format Menu

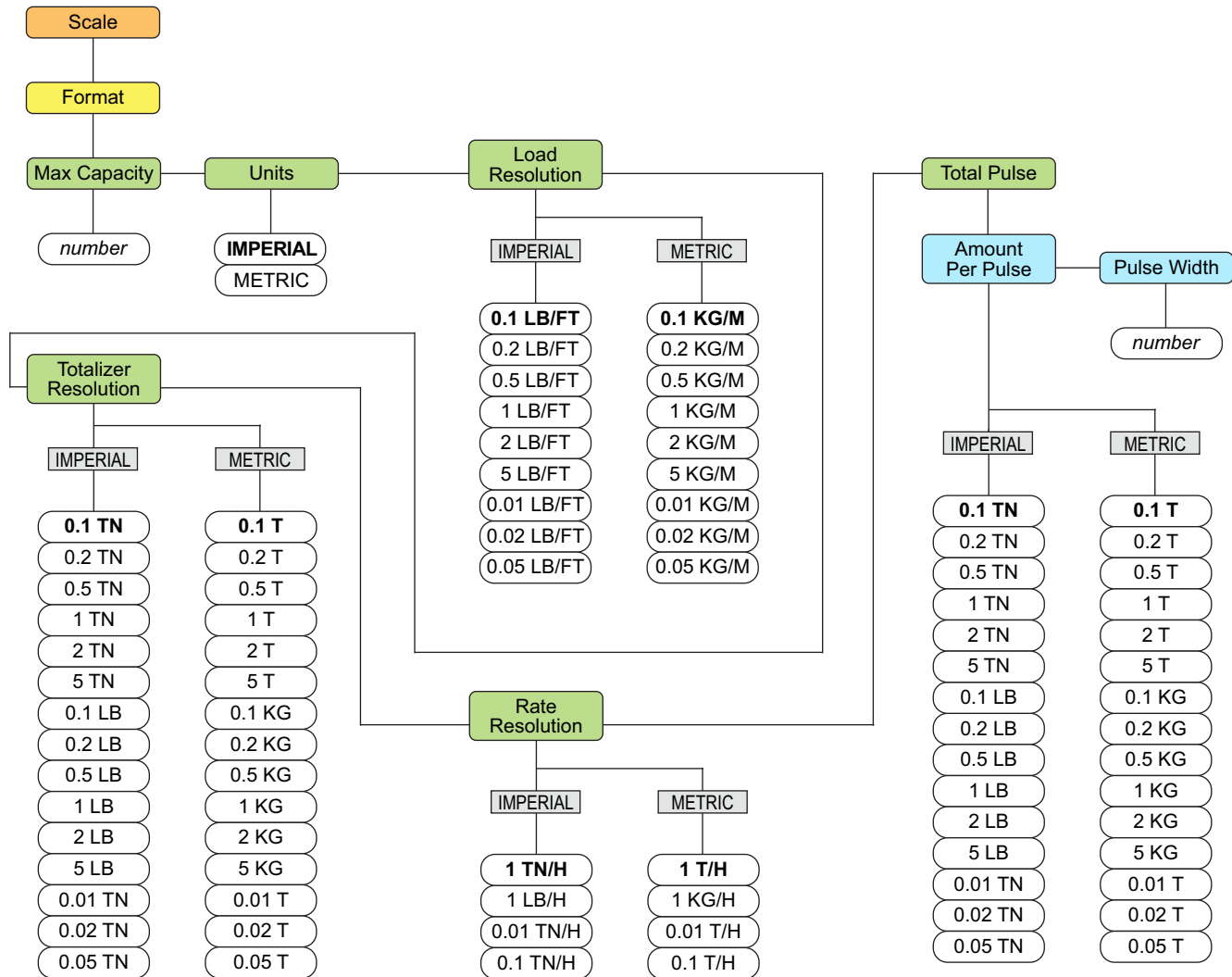

Figure 4-8. Scale – Format Menu

Parameter	Description
Max capacity	Maximum rated capacity (maximum weight) that can pass along the belt scale per hour; <i>Enter value: 1.0-9999999.0, 500.0 (default)</i>
Units	Select unit of measure to be used in the weigh mode; <i>Settings: METRIC, IMPERIAL</i>
Load Resolution	Resolution for the load value; <i>Select value: See Figure 4-8</i>
Totalizer Resolution	Resolution for the totalizer value; <i>Select value: See Figure 4-8</i>
Rate Resolution	Resolution for the rate value; <i>Select value: See Figure 4-8</i>
Total Pulse – Amount Per Pulse	Defines the change in total that will activate the Total Pulse digital output (if configured); <i>Example: If 1 TN is set, for every 1 TN change in the total, the Digital Output will be activated for a time defined by the Pulse Width parameter; Select value: See Figure 4-8</i>
Total Pulse – Pulse Width	Defines how long the tons per pulse output stays on, in milliseconds; <i>Enter value: 0-1000, 250 (default)</i>

Table 4-8. Scale – Format Menu Parameters

4.6.1.4 Scale – A/D Filter Menu

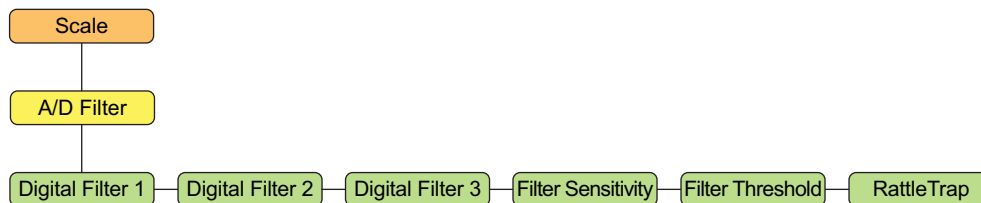

Figure 4-9. Scale – A/D Filter Menu

Parameter	Description
Digital Filter 1-3	Select the digital filtering rate used to reduce the effects of mechanical vibration from the immediate area of the scale; selected setting indicates the number of A/D conversions per update that are averaged to obtain the displayed reading; a higher number gives a more accurate display by minimizing the effect of a noisy reading, but slows down the settling rate of the indicator; <i>Select value: 4 (default), 8, 16, 32, 64, 128, 256, 1, 2</i>
Filter Sensitivity	Select the number of consecutive readings that must fall outside the Filter Threshold parameter before digital filtering is suspended; <i>Select value: 2OUT (default), 4OUT, 8OUT, 16OUT, 32OUT, 64OUT, 128OUT</i>
Filter Threshold	Select the Filter Threshold, in display divisions; when a specified number of consecutive scale readings (Filter Sensitivity parameter) fall outside of the threshold, digital filtering is suspended; the filter is always enabled if NONE is selected; <i>Select value: NONE (default), 2D, 5D, 10D, 100D, 200D, 250D</i>
RattleTrap	Effective at filtering repeating vibrations caused by mechanical noise from nearby machines, but may increase settling times over standard digital filter selections; <i>Select value: OFF (default), ON - enables RattleTrap®</i>

Table 4-9. Scale – A/D Filter Menu Parameters

4.6.1.5 Scale – Rate Dampening Menu

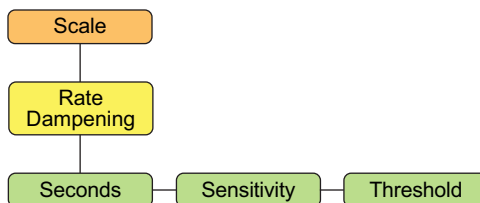

Figure 4-10. Scale – Rate Dampening Menu

Parameter	Description
Seconds	The number of seconds to average rate values; the damped rate value is what is shown on the weigh mode display and what is used for the analog output; a value of 0 turns off averaging; <i>Enter value: 0-600, 0 (default)</i>
Sensitivity	The rate dampening sensitivity specifies the number of consecutive rate value calculations that must fall outside the rate dampening threshold before digital filtering is suspended; it is also the number of consecutive rate value calculations that must fall inside the rate dampening threshold before digital filtering is resumed; <i>Enter value: 0-400, 50 (default)</i>
Threshold	The rate dampening threshold sets a value, in pounds, kilograms, tons or metric tons; the specific unit is dependent on the Units parameter and the Rate Resolution parameter; when a specified number of consecutive rate value calculations fall outside of this threshold, digital filtering is suspended; a value of 0 turns off the filter override; <i>Enter value: 0-1000, 200 (default)</i>

Table 4-10. Scale – Rate Dampening Menu Parameters

4.6.2 Setup – Features Menu

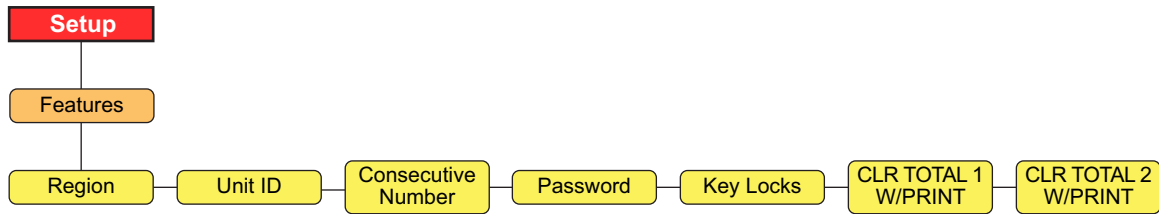

Figure 4-11. Setup – Features Menu

Parameter	Description
Region	See Section 4.6.2.1 for parameters
Unit ID	Specifies the unit identification string; <i>Settings: Enter string 1-16 characters, 1 (default)</i>
Consecutive Number	Current Value – Allows sequential numbering for print operations; The consecutive number value is incremented following each print operation that includes <CN> in the ticket format; <i>Enter value: 0-999999, 0 (default)</i>
	Reset Value – Specifies the value used when the consecutive number is reset by sending the KCLRCN serial command or a CLRCN digital input; <i>Enter value: 0-999999, 0 (default)</i>
Password	User – Protect items in the top level menu; If the value is zero the password is turned off; <i>Enter value: 0-999999, 0 (default)</i>
	Setup – Protect the setup menu; If the value is zero the password is turned off; <i>Enter value: 0-999999, 0 (default)</i>
	Totalizer – Protect totalizer 1-2 from being reset; If the value is zero the password is turned off; <i>Enter value: 0-999999, 0 (default)</i>
Key Locks	See Section 4.6.2.4 on page 36 for keys that can be locked
CLR Total 1 w/Print	The Totalizer 1 value is cleared when a print is performed; <i>Settings: No (default), Yes</i>
CLR Total 2 w/Print	The Totalizer 2 value is cleared when a print is performed; <i>Settings: No (default), Yes</i>

Table 4-11. Setup – Features Menu Parameters

4.6.2.1 Features – Region Menu

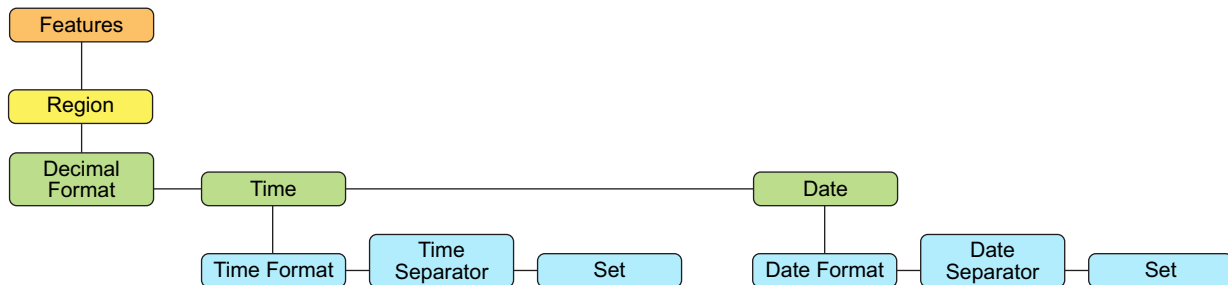

Figure 4-12. Features – Region Menu

Parameter	Description
Decimal Format	Set decimal symbol to display and print; <i>Settings: DOT (default), COMMA</i>
Time	Time Format – specify time format; <i>Settings: 12HOUR (default), 24HOUR</i>
	Time Separator – specify time separator; <i>Settings: COLON (default), COMMA</i>
	Set – enter current time
Date	Date Format – specify date format; <i>Settings: MMDDY4 (default), DDMMY4, Y4MMDD, Y4DDMM, MMDDY2, DDMMY2, Y2MMDD, Y2DDMM</i>
	Date Separator – specify date separator; <i>Settings: SLASH (default), DASH, SEMI</i>
	Set – enter the current date

Table 4-12. Features – Region Menu Parameters

4.6.2.2 Password Protection

The 882D supports a user password, a setup password, and a totalizer password. Passwords are numeric and will accept up to six characters. A password can be enabled by setting a non-zero value. By default the passwords are disabled (value of zero).

- The user password protects access to certain areas of the top level menu - Test, Time & Date and Setpoints are protected; Audit is not protected
- The setup password protects access to the setup menu; If the setup password is set with a non-zero value it must be entered whether using the setup switch (audit jumper OFF) or the front panel (audit jumper ON) to enter configuration
- The totalizer password protects totalizers 1 & 2 from being cleared in weigh mode

4.6.2.3 Configuration Reset Password

The configuration reset password is 999999.

Entering the configuration reset password at a password prompt resets the 882D - all configuration is returned to defaults. If either the user, setup or totalizer password has been forgotten, the configuration reset password can be entered to allow access to the 882D. This does not clear the master totalizer.

The configuration reset password is also a valid password for a customer to configure. If the customer forgets this password and calls Rice Lake (or looks it up in the manual) and is instructed to enter the configuration reset password, the configuration reset password allows them access without performing a reset of configuration.

4.6.2.4 Features – Key Locks Menu

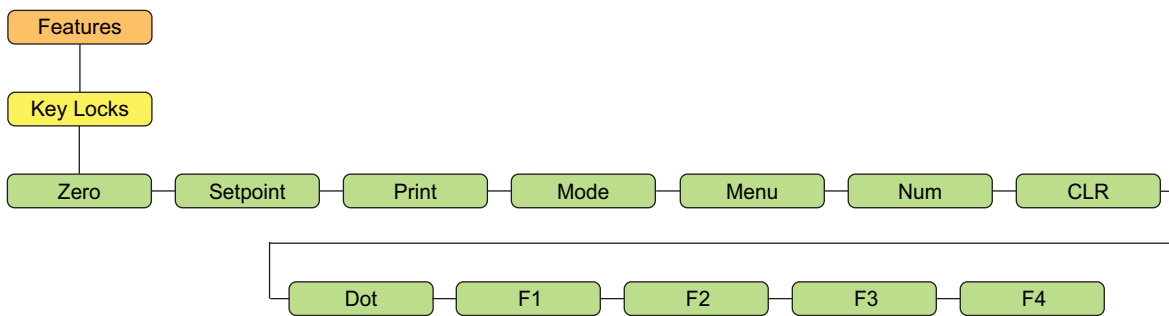

Figure 4-13. Features – Key Locks Menu

Parameter	Description
Zero	Lock or unlock individual keys; <i>Settings: UNLOCK (default), LOCK</i> NOTE: The Num parameter locks or unlocks all of the numeric keys. The numeric keys cannot be individually controlled.
Setpoint	
Print	
Mode	
Menu	
Num	
CLR	
Dot	
F1-4	

Table 4-13. Key Locks Available

4.6.3 Setup – Ports Menu

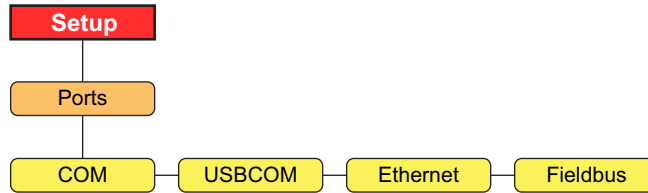

Figure 4-14. Setup – Ports Menu

Parameter	Description
COM	RS-232 and RS-485 Communications Port – see Figure 4-15
USBCOM	USB Device Port – see Figure 4-15
Ethernet	Ethernet TCP/IP Port – see Figure 4-16 on page 38 .
Fieldbus	Fieldbus option card port when installed – see Figure 4-16 on page 38

Table 4-14. Setup – Ports Menu Parameters

4.6.3.1 Ports – COM and USBCOM Menus

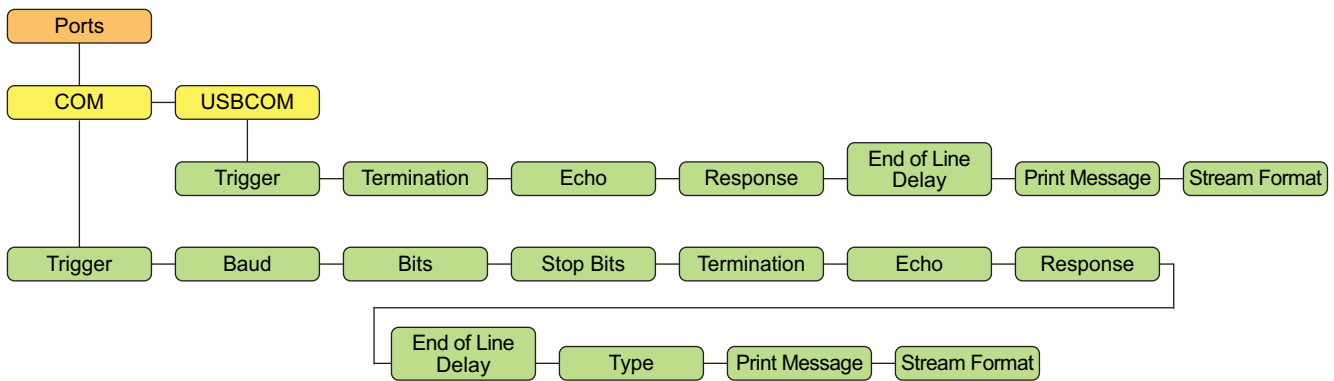

Figure 4-15. Ports – COM and USBCOM Menus



NOTE: USBCOM refers to the communication with the micro USB connector.

Parameter	Description
Trigger	COMAND (default) – allows operation of EDP commands and printing STRIND – stream Industrial data; data updated up to configured sample rate; allows operation of EDP commands and printing STRLFT – stream Legal for Trade data; data updated at configured display update rate; allows operation of EDP commands and printing PROGIN (Programmable input) – used with an iRite user program
NOTE: If Type is set to RS485, the port will not stream data. The 882D does not support local/remote operation. See Section 12.4.4 on page 95.	
Baud	Port baud rate (Not available in USBCOM); Settings: 1200-115200, 9600 (default)
Bits	Port data bits and parity (Not available in USBCOM); Settings: 8NONE (default), 7EVEN, 7ODD
Stop Bits	Stop Bits – selects the number of stop bits transmitted and the number of stop bits expected to be received by the port (Not available in USBCOM); Settings: 1 (default), 2
Termination	Termination – selects the termination character(s) for data sent from the port; Settings: CR/LF (default), CR
Echo	Specifies whether characters received by the port are echoed back to the sending unit; Settings: ON (default), OFF
Response	Specifies whether the port transmits replies to serial commands; Settings: ON (default), OFF
End of Line Delay	Specifies, in 0.1 second intervals, the delay between transmitted lines of data; Settings: 0 (default), 0-255
Type	Specifies the protocol for the COM port (Not available in USBCOM); Settings: 232 (default), 422, 485
Print Message	Displays a message when a print is transmitted on this port; Settings: ON (default), OFF
Stream Format	Specifies the stream format used for streaming output of scale data (Trigger=STRLFT or STRIND); <R><NL>(default)

Table 4-15. Ports – COM and USBCOM Parameters

4.6.3.2 Ports – Ethernet and Fieldbus Menus

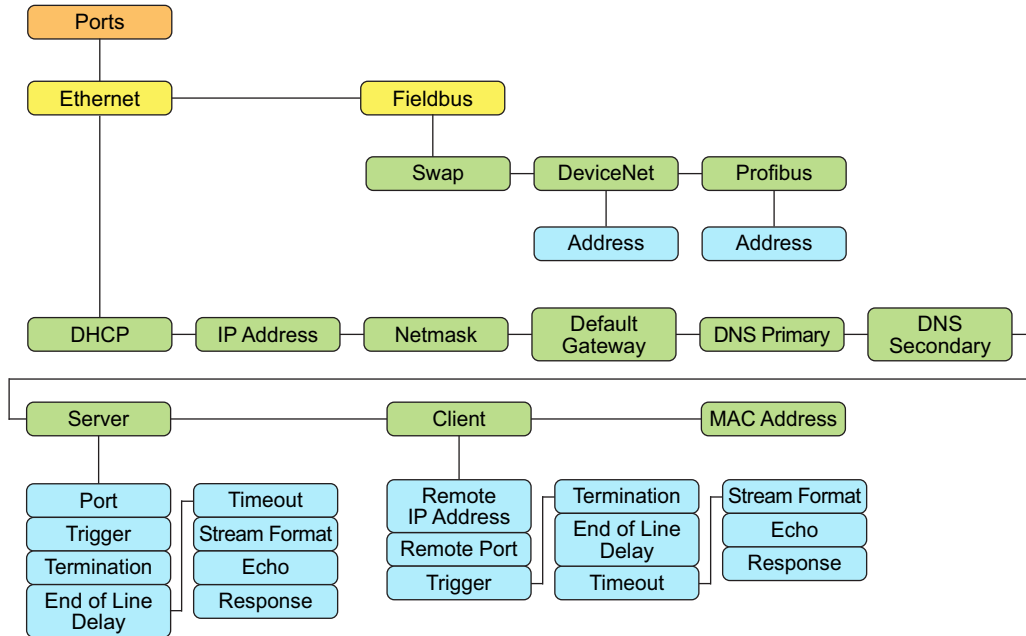

Figure 4-16. Ports – Ethernet and Fieldbus Menus

Ethernet Parameters

Parameter	Description
DHCP	Dynamic Host Configuration Protocol; <i>Settings: ON (default), OFF</i> If DHCP is ON, the five parameters below are configured and set automatically by the network's DHCP server; If DHCP is OFF, the five parameters below must be manually configured as needed
IP Address	IP address (000.000.000.000)
Netmask	Netmask (000.000.000.000)
Default Gateway	IP address for the Default Gateway; (000.000.000.000)
DNS Primary	IP address for the primary DNS server; (000.000.000.000)
DNS Secondary	IP address for the secondary DNS server; (000.000.000.000)
Server	See sub-menu parameters below
Client	See sub-menu parameters below
Mac Address	The MAC address for this device; <i>Read Only</i>
Server/Client Sub-menu	
Remote IP Address	Client only: the IP address of the remote server the 882D is connecting to (000.000.000.000)
Remote Port	Client only: the TCP port number of the remote server the 882D is connecting to; <i>Enter value: 1-65535, 1 (default)</i>
Port	Server only: The TCP port number of the 882D server; <i>Enter value: 1-65535, 10001 (default)</i>
Trigger	Select the operation of the port; <i>Settings:</i> <i>COMAND (default) – allows operation of EDP commands and will print</i> <i>STRIND – stream industrial scale data – data is transmitted up to the configured A/D sample rate; Will also accept EDP commands and printing</i> <i>STRLFT – stream legal for trade scale data – data is transmitted at the configured display update rate; Will also accept EDP commands and printing</i> <i>PROGIN – programmable input for use with an iRite user program</i>
Termination	Selects the termination character(s) for data sent from the port; <i>Settings: CR/LF (default), CR</i>
End of Line Delay	Specifies the delay between transmitted lines of data, in 0.1 second intervals; <i>Enter value: 0-255, 0 (default)</i>
Timeout	Connection (client or server) is closed if there is no activity before the set time; 0 disables the inactivity disconnect; <i>Enter value: 0-65535 (seconds), 0 (default)</i>

Table 4-16. Ports – Ethernet Parameters

Parameter	Description
Stream Format	Specifies the stream format used for streaming output of data (Trigger = STRLFT or STRIND); Alpha/numeric maximum length 200 characters; <R><NL> (default)
Echo	Specifies whether characters received by the port are echoed back to the sending unit; Settings: OFF (default), ON
Response	Specifies whether the port transmits replies to serial commands; Settings: ON (default), OFF NOTE: If an external device (such as a printer), that may transmit unexpected data (such as a paper low message), is connected to the 882D the response parameter should be set to OFF to prevent a reply from the 882D from confusing the external device.

Table 4-16. Ports – Ethernet Parameters (Continued)

Fieldbus Parameters

Parameter	Description
Swap	Specifies byte-swapping used for the fieldbus card. For DeviceNet cards, this parameter defaults to BYTE; for all other cards the default value is None; Settings: NONE (default), BYTE, BOTH
DeviceNet	Specifies the DeviceNet address; Address – Enter value: 1-64, 63 (default)
Profibus	Specifies the Profibus address; Address – Enter value: 1-126, 126 (default)

Table 4-17. Ports – Fieldbus Parameters

4.6.4 Setup – Print Format Menu

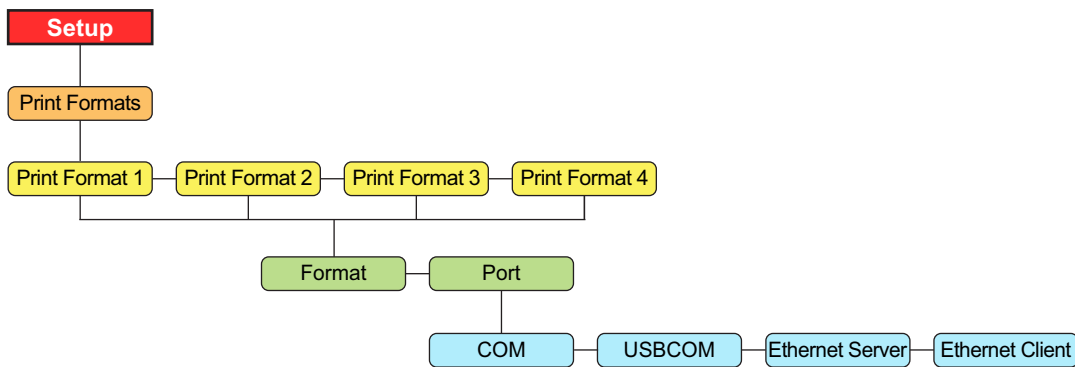

Figure 4-17. Setup – Print Format Menu

Parameter	Description
Format	Set format needed to print tickets; see Section 8.0 on page 77
Port	Communications port the print data will be sent to: COM – RS-232/422 port; J3 USBCOM – USB Device Port; J4 Ethernet Server – J6 Ethernet Client – J6 Ports can be configured as ON or OFF; COM is ON by default and the others are OFF by default When a Print Format is requested, it will be sent simultaneously out all of the ports configured as ON

Table 4-18. Setup – Print Format Parameters

4.6.5 Setup – Setpoints Menu

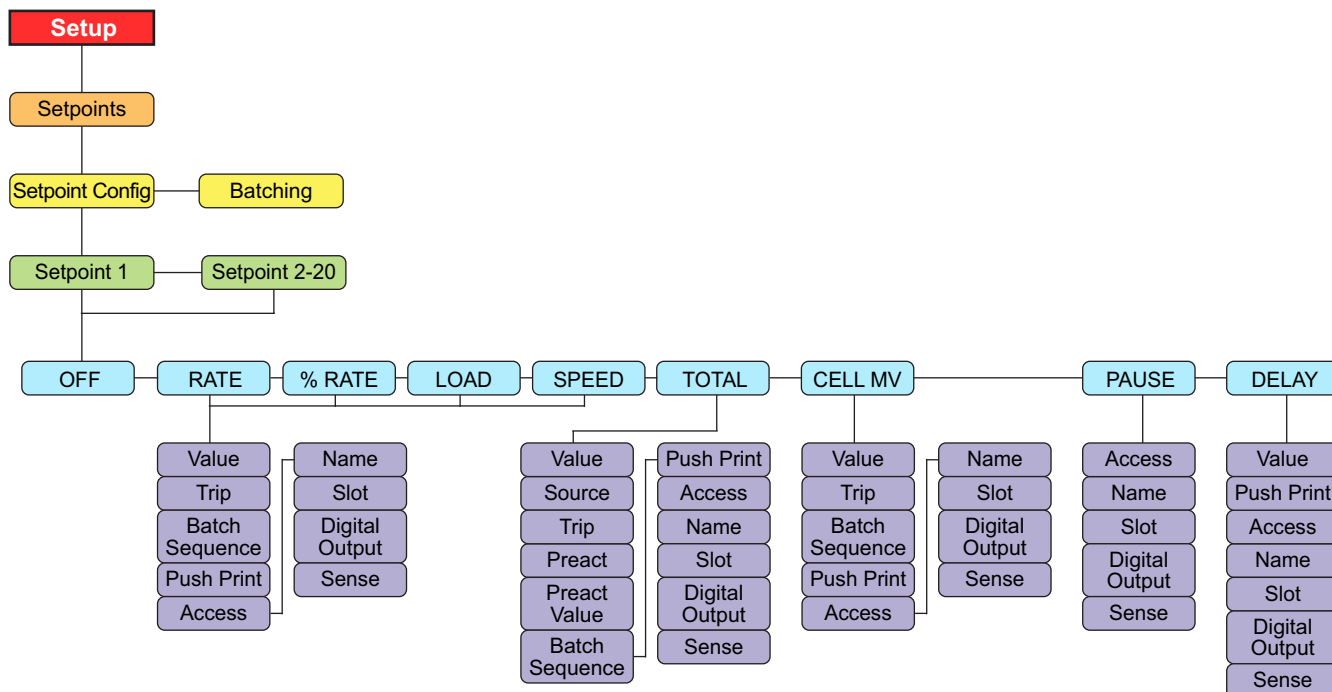

Figure 4-18. Setup – Setpoints Menu

Parameter	Description
Setpoint Config	20 setpoint steps are supported; See Table 4-20 for the setpoint types and descriptions; <i>Settings: Setpoint 1-20</i>
Batching	Set to MANUAL to allow a batch sequence to run; MANUAL requires a BATSTR digital input or BATSTART serial command before the batch sequence can run; <i>Settings: OFF (default), MANUAL</i>

Table 4-19. Setup – Setpoints Menu Parameters



NOTE: Setpoint 20 is not available if the Speed Input Type is set to PLC (see [Section 4.6.1.1](#) on page 31).

Parameter	Description
OFF	Setpoint turned off/ignored (<i>default</i>)
RATE	Rate setpoint: Performs functions based on the current rate; <i>Settings: Value, Trip, Batch Sequence, Push Print, Access, Name, Slot, Digital Output, Sense</i>
% RATE	Percent rate setpoint: Performs functions based on a specified percentage of the configured max capacity; <i>Settings: Value, Trip, Batch Sequence, Push Print, Access, Name, Slot, Digital Output, Sense</i>
LOAD	Load setpoint: Performs functions based on the current load; <i>Settings: Value, Trip, Batch Sequence, Push Print, Access, Name, Slot, Digital Output, Sense</i>
SPEED	Speed setpoint: Performs functions based on the belt speed; <i>Settings: Value, Trip, Batch Sequence, Push Print, Access, Name, Slot, Digital Output, Sense</i>
TOTAL	Totalizer setpoint: Performs functions based on the totalizer value; <i>Settings: Value, Source, Trip, Preact, Preact Value, Batch Sequence, Push Print, Access, Name, Slot, Digital Output, Sense</i>
CELL MV	Load cell millivolt setpoint: Performs functions based on the current cell mV reading; <i>Settings: Value, Trip, Batch Sequence, Push Print, Access, Name, Slot, Digital Output, Sense</i>
PAUSE	Pauses the batch sequence indefinitely; a BATSTR signal must be initiated to continue the batch process; <i>Settings: Access, Name, Slot, Digital Output, Sense</i>
DELAY	Delays the batch sequence for a specified time; the length of the delay (in tenths of a second) is specified on the Value setting; <i>Settings: Value, Push Print, Access, Name, Slot, Digital Output, Sense</i>

Table 4-20. Setup – Setpoint Parameters



NOTE: Refer to [Table 4-21 on page 41](#) for setpoint parameter settings and descriptions.

Setting	Description
Value	For time-based setpoints: Specifies, in 0.1 second intervals, a time value; For all other setpoints: Specifies the target value; <i>Settings: 0.000000 (default)</i> <i>0.0-65535 – for the DELAY setpoint</i> <i>0.0-999999 – for the RATE, %RATE, LOAD, SPEED, TOTAL and CELLMV setpoints</i>
Source	The source for a TOTAL setpoint type; <i>Settings: TOTALIZER 1 (default), TOTALIZER 2, MASTER</i>
Trip	Specifies whether the setpoint is satisfied when the weight is higher or lower than the setpoint value; <i>Settings if using batch setpoints:</i> <i>HIGHER (default) – the associated digital output is active until the setpoint value is reached or exceeded</i> <i>LOWER – the associated digital output is active until the current value goes below the setpoint value</i> <i>Settings if using continuous setpoints:</i> <i>HIGHER (default) – the associated digital output is active when the associated value is greater (higher) than the setpoint value</i> <i>LOWER – the associated digital output is active when the associated value is less (lower) than the setpoint value</i>
Preact	Allows the digital output associated with a setpoint to shut off before the setpoint is satisfied to allow for material in suspension; <i>Settings:</i> <i>OFF (default) – disables the preact</i> <i>ON – adjusts the setpoint trip value up or down (depending on the TRIP parameter setting) from the setpoint value using a fixed value specified on the Preact Value parameter; Weight based example - a value of 2 = turn off 2 tons early</i> <i>LEARN – monitors the load amount on the specified distance of belt and adjusts the setpoint trip value up or down (depending on the TRIP parameter setting); For example - a value of 15 ft (and a current load of 20 lb/ft) will turn off 0.08 tons early, 20 lb x 15 ft = 300 lb = 0.08 tons</i>
Preact Value	Specifies the preact value for setpoints with Preact set to ON or LEARN; Depending on the trip setting specified for the setpoint, the setpoint trip value is adjusted up or down by the Preact Value; <i>Enter value: 0.0-999999.0, 0.0 (default)</i>
Batch Sequence	Specifies whether the setpoint is used as a batch (ON) or continuous (OFF) setpoint; <i>Settings: OFF (default), ON</i>
Push Print	Specifies which print format to transmit; <i>Settings: NONE (default), PRINT FORMAT 1, PRINT FORMAT 2, PRINT FORMAT 3, PRINT FORMAT 4</i>
Access	Specifies the access allowed to setpoint parameters through the setpoint key; <i>Settings:</i> <i>ON (default) – values can be displayed and changed</i> <i>OFF – values can be displayed but not changed</i>
Name	Setpoint name string; <i>Settings: (six characters)</i>
Slot	Digital output slot; Lists all digital I/O slots that have at least one bit configured as an output; This parameter specifies the slot number of the digital I/O card referenced by the Digital Output parameter; <i>Settings:</i> <i>NONE (default) – specifies no digital output being used by the setpoint</i> <i>SLOT0 – the onboard digital outputs; only shown if at least one output is configured</i> <i>SLOT1 – the digital I/O option card; only shown if the card is installed and if at least one output is configured</i> <i>SLOT2 – the digital I/O option card; only shown if the card is installed and if at least one output is configured</i> <i>Refer to Section 4.6.6 on page 42 to activate setting.</i>
Digital Output	Lists all digital output bits available for the specified Slot; This parameter is used to specify the digital output bit associated with this setpoint; Use the Digital I/O menu to assign bit function to output; For continuous setpoints, the digital output becomes active (low) when the condition is met; for batch setpoints, the digital output is active until the setpoint condition is met; <i>Settings: NONE (default), BIT1-24 (refer to Section 4.6.6 on page 42 to activate setting)</i>
Sense	Digital output sense; Specifies whether the value of the digital output associated with this setpoint is inverted when the setpoint is satisfied; <i>Settings: NORMAL (default), INVERT</i>

Table 4-21. Setpoint Parameter Settings

4.6.6 Setup – Digital I/O Menu

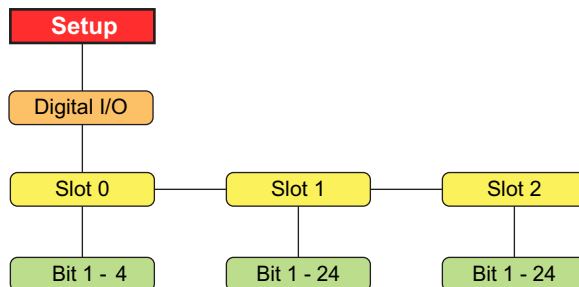

Figure 4-19. Setup – Digital I/O Menu



NOTE: When using a fixed speed or PLC provided belt speed, the usage of a BELTRUNNING digital input is mandatory.

- The digital input configured as BELTRUNNING requires contact closure between the input pin and ground (for example J2 pin 2).
- Digital inputs configured as BELTRUNNING must be low (grounded) while the belt is running. Not grounding the digital input forces the 882D's belt speed to 0, calibration issues, etc.
- If a belt running contact closure is not available on the external equipment, the BELTRUNNING digital input must be connected to ground with a jumper wire.



NOTE: When calculating belt speed with a Pulse input, using BELTRUNNING as a digital input is optional. Configure a BELTRUNNING digital input if the external equipment has a belt running contact closure.

Parameter	Description
Slot 0	Select the bit to set the function; <i>Settings: Bit 1 - 4</i>
Slot 1	<i>Settings: Bit 1 - 24</i>
Slot 2	
Slot 0-2 submenu	
Bit n	<p>Specifies the function activated by Bits n; <i>Settings:</i></p> <ul style="list-style-type: none"> OFF (default) – turned off PRINT, ZERO, CLEAR, MODE – provide the same functions as the front panel keys CLRCN – resets the consecutive number to the value specified on the Reset Value parameter (Features menu, Table 4-11 on page 35) BATRUN – allows a batch routine to be started and run; With BATRUN active (low), the BATSTR input starts the batch; if BATRUN is inactive (high), BATSTR resets the batch BATSTR – starts or resets a batch routine, depending on the state of the BATRUN input BATPAS – pauses a batch routine while held active (low) BATRST – resets a batch to first batch setpoint BATSTP – stops a batch at the current step KBDLOC – locks the keyboard OUTPUT – defines a bit as an output to be used by a setpoint INPUT – assigns the bit as a digital input that can be read with the GetDigin iRite API PROGIN – assigns the bit as a digital input used to generate an iRite program event BELTRUNNING – an input to tell the 882D the belt is running; if not configured, the belt is always considered running; must be configured if using Fixed Speed or PLC provided belt speed CLRTOT1 – clears Totalizer 1 CLRTOT2 – clears Totalizer 2 TOTALIZERPULSE – an output that pulses with each predefined amount of material that crosses the scale; See Total Pulse parameters in Figure 4-8 on page 33 to configure the amount indicated by each pulse

Table 4-22. Setup – Digital I/O Menu Parameters

4.6.7 Setup – Analog Output Menu

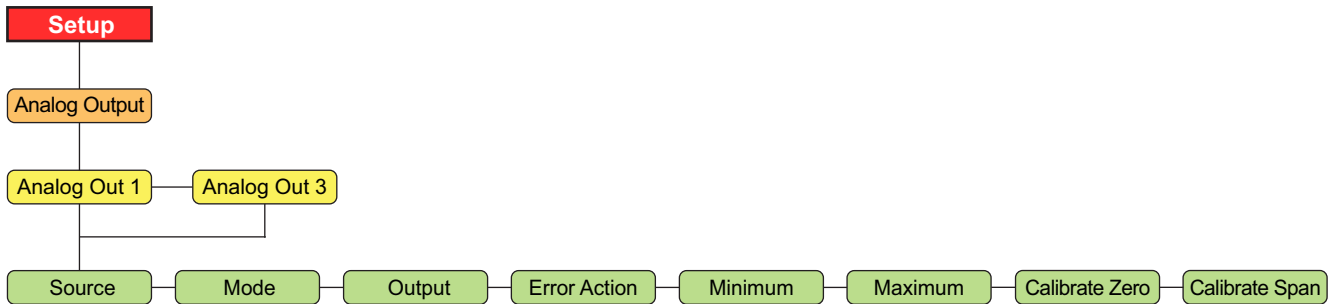

Figure 4-20. Setup – Analog Output Menu



NOTE: Option slot 1 on the CPU board is Analog Out 1 and option slot 2 is Analog Out 3.

Parameter	Description
Source	Specifies the source of the analog output control; Settings: SCALE (default) – Indicates that the analog output will follow the configured mode based on scale data. PROG – Indicates that the analog output is under iRite program control
Mode	Specifies the data tracked by the analog output; Source must be configured for SCALE for the analog output to follow any of these modes; Settings: RATE (default), SPEED, LOAD
Output	Specifies the output type; This parameter must be set before calibrating the analog output; Settings: 0–10 V (default), 0–20mA, 4–20mA
Error Action	Specifies how the analog output responds to system error conditions; Settings: FULLSC (default) – Set to full value (10 V or 20 mA, depending on output setting) HOLD – Hold current value ZEROSC – Set to zero value (0 V, 0mA or 4 mA, depending on output setting)
Minimum	Specifies the minimum value tracked; Enter value: 0–999999, 0.0 (default)
Maximum	Specifies the maximum value tracked; Enter value: 0–999999, 10000.0 (default)
Calibrate Zero	Adjust the analog output zero calibration; See Section 12.5 on page 96 Edit the value to match reading on multimeter to perform calibration
Calibrate Span	Adjust the analog output span calibration; See Section 12.5 on page 96 Edit the value to match reading on multimeter to perform calibration

Table 4-23. Setup – Analog Output Menu Parameters

4.6.8 Setup – Version Menu

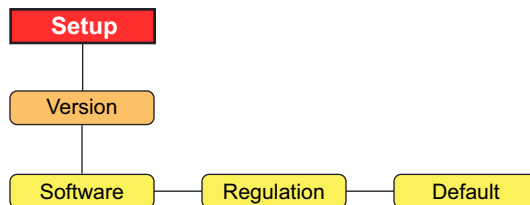











Figure 4-21. Setup – Version Menu

Parameter	Description
Software	Displays firmware version number (read only); VX.XX.XX 882D CCCC <i>NOTE: The CCCC is the 4-digit firmware checksum</i>
Regulation	Displays the Legally Relevant firmware version number (read only); LRVX.XX
Default	Performs a reset of all the 882D parameters to factory default settings; <i>Settings: NO, YES</i> <i>Important: All configuration and calibration data will be lost</i>

Table 4-24. Setup – Version Menu Parameters

4.6.8.1 Defaulting 882D

A complete default can be done to the 882D. This will clear the totalizers and the calibration settings. The 882D will be returned to all default settings.

1. Press . *Audit* is displayed.
2. Press . *Setup* is displayed.
3. Press . *Scale* is displayed.
4. Press . *Version* is displayed.
5. Press . *Software* is displayed.
6. Press . *Default* is displayed.
7. Press . *NO* is displayed.
8. Press . *YES* is displayed.
9. Press . *SAVED* then *RESET* briefly display.
10. Press  to return to the weigh mode.

4.7 Test Menu

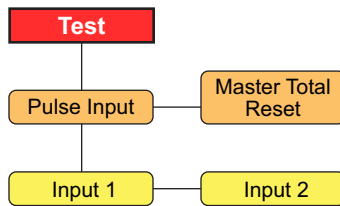

Figure 4-22. Test Menu

Parameter	Description
Pulse Input	Displays the current PPS (pulses per second) from the speed sensor (read only); <i>Settings:</i> <i>Input 1</i> - primary pulse input <i>Input 2</i> - secondary pulse input This informational menu can be used for troubleshooting purposes
Master Total Reset	Option to reset the master total; <i>Settings:</i> NO (default), YES

Table 4-25. Test Menu Parameters

4.8 Time & Date Menu

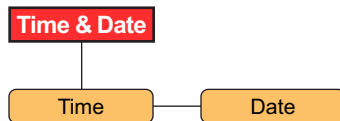

Figure 4-23. Time & Date Menu

Parameter	Description
Time	Set the current time
Date	Set the current date

Table 4-26. Time & Date Menu Parameters



NOTE: Refer to [Section 4.6.2.1 on page 35](#) for time and date formatting options.

5.0 Calibration

The 882D Belt Scale Integrator must calibrate inputs from the speed sensor and weigh frame for the system to work.



NOTE: The speed sensor calibration must be done prior to the weigh frame calibration.

5.1 Speed Sensor Calibration

A belt conveyor scale must be equipped with a belt speed sensor that accurately senses the belt speed when the belt is empty or loaded.

The purpose of the calibration is to determine a belt speed in either m/s or ft/s (depending on the units setting).

There are three types of speed sensor calibrations supported:

- **Calculated** – the belt speed is calculated from known parameters of the speed sensor.
- **Revolutions** – the belt speed is determined by measuring the number of complete revolutions.
- **Distance** – the belt speed is determined by measuring the speed sensor output over a set distance.



NOTE: Only one of these methods should be performed.

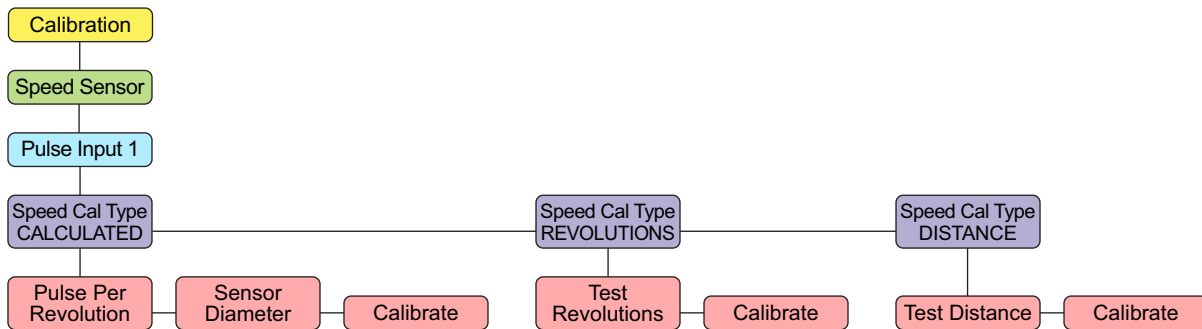

Figure 5-1. Speed Sensor Calibration Menu

5.1.1 Calculated

This section details speed sensor calibration via the Calculated method. The belt speed is determined by the diameter of the sensor (which is needed to find its circumference) and its pulses per revolution.

Calculation

The sensor circumference is divided by the seconds per revolution and then multiplied by 60 to calculate the belt's speed in feet per minute.

The circumference of the sensor is determined with the equation:

$$C = \pi \times d$$

Example: Assume the speed sensor outputs 120 pulses per second, is rated at 250 pulses per revolution and has a diameter of 6 inches.

Circumference:

$$C = 3.14159 \times 0.5 \text{ feet}$$

$$C = 1.570795 \text{ feet per revolution}$$

Pulses per revolution / Pulses per second:

$$250 / 120 = 2.08333 \text{ seconds per revolution}$$

Distance per minute:

$$1.570795 / 2.08333 = 0.753983 \text{ feet per second}$$

$$0.753983 \times 60 \text{ seconds per minute} = 45.23897 \text{ feet per minute}$$

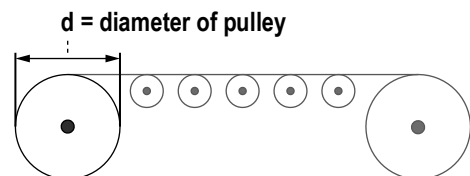













Figure 5-2. Measure of Pulley Diameter

Calculated Speed Calibration

1. Navigate to *Calibration* within the Setup menu ([Section 4.6.1 on page 30](#)).
2. Press . *Speed Sensor* displays.
3. Press . *Pulse Input 1* displays.
4. Press . *Speed Cal Type CALCULATED* displays.
5. Press . *Pulse Per Revolution* displays.
6. Press . The current *Pulse Per Revolution* value displays.
7. Enter required value using the keypad.
8. Press . *Sensor Diameter* displays.
9. Press . The current *Sensor Diameter* value displays.
10. Enter required value using the keypad.
11. Press . *Calibrate* displays.
12. Press . *Start To Begin* displays.
13. Press . *Complete* briefly flashes in the messaging area.
14. Press  to return to the weigh mode.

5.1.2 Revolutions

This section details speed sensor calibration via the number of belt revolutions. The distance per pulse is determined by how many pulses are received for a number of belt revolutions. The *Belt Length* parameter must be configured before this calibration is performed.

Calculation

The distance traveled during the calibration is divided by the calibration time in seconds and multiplied by 60 to calculate the belt's speed in feet per minute.

Example: Assume the belt is 100 feet and travels 3 revolutions in 240 seconds.

Total distance traveled:

$$100 \times 3 = 300 \text{ feet traveled}$$

Time conversion:

$$240 / 60 = 4 \text{ minutes}$$

Distance per minute:

$$300 / 4 = 75 \text{ feet per minute}$$

Revolutions Speed Calibration



1. Mark a reference point on the conveyor belt and conveyor frame. This allows for counting the number of revolutions the belt travels during the speed calibration. The more revolutions in a test, the better the speed and distance accuracy.



NOTE: *Time a belt revolution with a stop watch if the belt is not visible from the 882D. Use the reference marks on the belt and conveyor frame to accurately time a complete revolution.*



Be sure to configure the conveyor belt length before performing a Revolutions calibration.

2. Navigate to *Calibration* within the Setup menu ([Section 4.6.1 on page 30](#)).

3. Press . *Speed Sensor* displays.
4. Press . *Pulse Input 1* displays.
5. Press . *Speed Cal Type CALCULATED* displays.
6. Press  to scroll to *REVOLUTIONS*.
7. Press . *Test Revolutions* displays.
8. Press . The current *Test Revolutions* value displays.
9. Enter expected value using the keypad.
10. Press . *Calibrate* displays.
11. Press . *Press Start To Begin* displays.
12. Press . This causes the 882D to display:
 - *Pulses*: – displays the pulses counted
 - *Run Time*: – displays the run time as minutes and seconds
 - *Press Stop To Finish* – displays in the lower line of the messaging area



NOTE: *If the pulses are not changing there is a problem with the speed sensor and can be a sign that the wiring or the sensor is bad.*

13. Press  to stop the calibration once the belt has completed the desired number of revolutions.
14. The current value of *Test Revolutions* displays again.
15. Enter the number of revolutions just completed using the keypad.
16. Press . The 882D determines the pulses per unit of measure to be used for displaying the speed of the belt and totalizing the weight during operation.
17. Press  to return to the weigh mode.

The number of belt revolutions is stored. This value is used for dynamic span calibration (static weight or test chain span calibration) when the 882D is calibrated to the load cell.

5.1.3 Distance

This section details speed sensor calibration via belt travel distance. The belt speed is determined by how many pulses are received for a length of belt travel.

Calculation

The distance traveled during the calibration is divided by the calibration time in seconds and multiplied by 60 to calculate the belt's speed in feet per minute.







Example: Assume the belt travels a test distance of 100 feet in 40 seconds.

Distance per minute:

$$100 / 40 = 2.5 \text{ feet per second}$$



$$2.5 \times 60 \text{ seconds per minute} = 150 \text{ feet per minute}$$

Distance Speed Calibration

1. Navigate to *Calibration* within the Setup menu (Section 4.6.1 on page 30).
2. Press . *Speed Sensor* displays.
3. Press . *Pulse Input 1* displays.
4. Press . *Speed Cal Type CALCULATED* displays.
5. Press  to scroll to *DISTANCE*.
6. Press . *Test Distance* displays.
7. Press . The current *Test Distance* value displays.
8. Enter required value using the keypad.





NOTE: Two reference points must be marked on the conveyor belt and one reference point must be marked on the conveyor frame. This gives the operator a reference for the distance that the belt travels during the speed calibration.

9. Press . *Calibrate* displays.
10. Press . *Press Start To Begin* displays.
11. Press . This causes the 882D to display:
 - *Pulses*: – displays the pulses counted
 - *Run Time*: – displays the run time as minutes and seconds
 - *Press Stop To Finish* – displays in the lower line of the messaging area



NOTE: If the pulses are not changing there is a problem with the speed sensor and can be a sign that the wiring or the sensor is bad.

12. Press  to stop the calibration as close as possible to the specified test distance.
13. The current value of *Test Distance* displays again.
14. Enter the distance value just completed using the keypad.
15. Press . *Calibrating...* briefly displays. The 882D determines the pulses per unit of measure to be used for displaying the speed of the belt and totalizing the weight during operation.
16. Press  to return to the weigh mode.

5.2 Weigh Frame Calibration

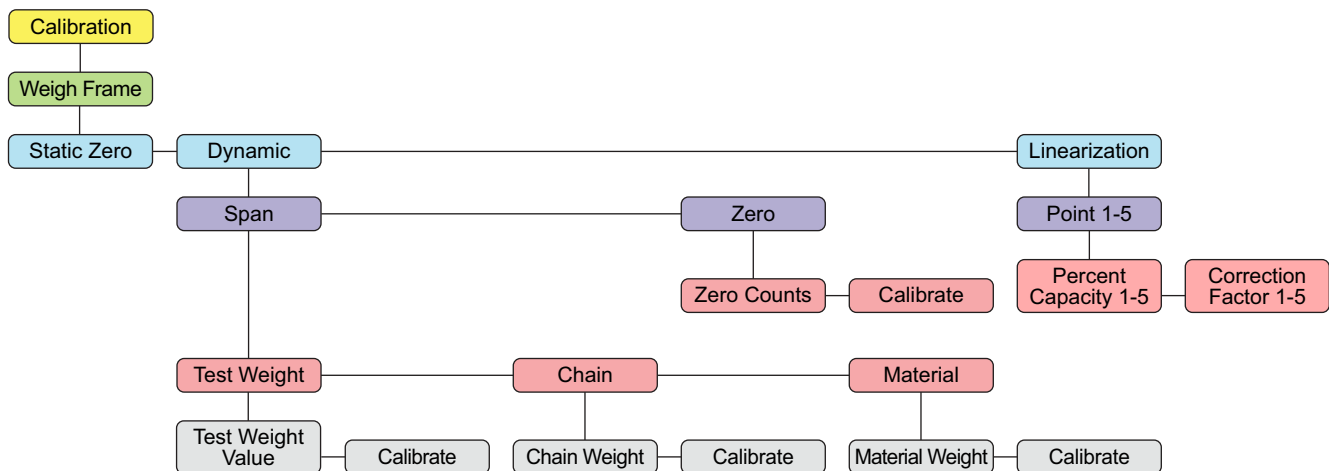

Figure 5-3. Weigh Frame Calibration Menu

5.2.1 Static Zero

Zero calibration of the 882D while the belt is not in motion. The zero calibration is based on four seconds of A/D readings.

Static Zero Calibration

1. Navigate to *Calibration* within the Setup menu ([Section 4.6.1 on page 30](#)).
2. Press . *Speed Sensor* displays.
3. Press to scroll to *Weigh Frame*.
4. Press . *Static Zero* displays.
5. Press . *Press Start to Begin* displays.
6. Ensure that there is no material on the belt.
7. Press to initiate the calibration sequence. *Calibrating...* displays on the upper messaging line and a bar graph on the bottom line displays the progress of the calibration.



NOTE: Once “*Press Start to Begin*” displays, pressing *MENU* is the only way to cancel.

8. After the calibration is complete *Static Zero* displays again. Press to return to the weigh mode.

5.2.2 Dynamic Span











NOTE: See [Section 5.2.3 on page 52](#) to run a dynamic zero calibration before proceeding with a span calibration. The dynamic zero determines the span’s reference point.

5.2.2.1 Test Weight or Chain

Select *Test Weight* or *Chain* to calibrate the span using the number of revolutions as a reference for the calibration duration. Span calibrations are based on belt length defined by number of revolutions and uses static test weights or chains.



Test Weight or Chain Span Calibration

1. Navigate to *Calibration* within the Setup menu ([Section 4.6.1 on page 30](#)).
2. Press . *Speed Sensor* displays.
3. Press to scroll to *Weigh Frame*.
4. Press . *Static Zero* displays.

5. Press  to scroll to *Dynamic*.
6. Press . *Span* displays.
7. Press . *Test Weight* displays. If using chain, press  to display *Chain*.
8. Press . *Test Weight Value* displays (*Chain Weight*, if using chain).
9. Press . The current *Test Weight Value* or *Chain Weight* displays.
10. Enter the amount of test weight being used or the chain weight with the keypad.
11. Load the scale with weights or chains, press . *Calibrate* displays.
12. Press . *Press Start to Begin* displays.











NOTE: Ensure the belt is running prior to pressing Start.

13. Press . *Calibrating...* displays.
 - The 882D starts taking span averages
 - During calibration the test totalizer displays in the numeric area, a progress bar graph displays in the messaging area
 - The weight being totalized during calibration displays at x10 resolution
 - Calibration runs for the Test Distance set in the Configuration menu (default 20 ft/m)
 - The 882D displays the previous error, the current error and displays *Enter Key To Accept* on the bottom line of the messaging area
 14. Press . *ACCEPTED* displays, the error and the new span value is stored.
- OR -
- Press  to reject the calibration. *REJECTED* displays.

5.2.2.2 Material







Use this method to calibrate the scale with a known amount of material. The material must be pre weighed or post weighed.

Material Calibration

1. Navigate to *Calibration* within the Setup menu ([Section 4.6.1 on page 30](#)).
2. Press . *Speed Sensor* displays.
3. Press  to scroll to *Weigh Frame*.
4. Press . *Static Zero* displays.
5. Press  to scroll to *Dynamic*.
6. Press . *Span* displays.
7. Press . *Test Weight* displays.
8. Press  to scroll to *Material*.
9. Press . *Material Weight* displays.





NOTE: The pre or post weighed material weight is entered in [Step 14](#).

10. Press . *Calibrate* displays.
11. Press . *Press Start to Begin* displays.
12. Press . The 882D starts recording span averages.
 - Displays: *Calibrating...*
Run Time: XX:XX
 - The weight being totalized during calibration displays in the numeric area at x10 resolution.
 - Total annunciator is lit, but 1 and 2 are not.
13. Once the material is run across the belt scale, press  to end the sequence.
14. The 882D prompts for the amount of material in tons with the previously entered value as a default starting point.
15. Press  to accept the default value
- OR -
Use the keypad to enter a new value and press . The new value is saved to configuration.











NOTE: Pressing  *aborts the calibration.*

16. The 882D displays the previous error, the current error and prompts to accept or reject the calibration. *Enter Key To Accept* displays on the bottom line of the messaging area.
17. Press . *ACCEPTED* displays, the error and the new span value is stored.
- OR -
Press  to reject the calibration. *REJECTED* displays.

5.2.3 Dynamic Zero

Zero calibration of the 882D while the belt is in motion.



Dynamic Zero Calibration

1. Navigate to *Calibration* within the Setup menu ([Section 4.6.1 on page 30](#)).
2. Press . *Speed Sensor* displays.
3. Press  to scroll to *Weigh Frame*.
4. Press . *Static Zero* displays.
5. Press  to scroll to *Dynamic*.
6. Press . *Span* displays.
7. Press  to scroll to *Zero*. Ensure there is no load on the belt and that the belt is moving.
8. Press . *Zero Counts* displays.
9. Press  to scroll to *Calibrate*.
10. Press . *Press Start to Begin* displays.

11. Press . If a *Speed Sensor Calculation* was performed, the unit prompts for a distance to calibrate.
 - The 882D will start taking zero averages.
 - During calibration the test totalizer displays in numeric area, a progress bar graph displays in messaging area
 - The weight being totalized during calibration displays at x10 resolution







NOTE: Press  to cancel the calibration, if needed. Canceled displays momentarily and the 882D exits the calibration.

12. Calibration runs for the calibrated distance (or the entered distance if using Calculated Speed). After the 882D has run the zero calibration, the new zero error % and the previous zero error % display. Press *Enter To Accept* displays on the bottom line of the messaging area.
 13. Press  to accept the calibration. *Zero ACCEPTED* flashes briefly, and the new zero error % is stored – the test totalizer value is not adjusted.
- OR -
- Press  to reject the calibration. *REJECTED* displays.

5.2.4 Linearization







Linearization allows up to five correction points to be configured as a percentage of *Max Capacity*. A separate *Percent Capacity* and *Correction Factor* is maintained for each *Point*. A span calibration ([Section 5.2.2 on page 50](#)) clears out any existing linearization points and populates *Point 1* by setting *Percent Capacity 1* to 100.0 and creating a value for *Correction Factor 1*.

Linearization Point Entry

1. Navigate to *Calibration* within the Setup menu ([Section 4.6.1 on page 30](#)).
2. Press . *Speed Sensor* displays.
3. Press  to scroll to *Weigh Frame*.
4. Press . *Static Zero* displays.
5. Press  to scroll to *Linearization*.
6. Press . *Point 1* displays.



NOTE: A span calibration populates the *Correction Factor 1* percentage value for *Point 1*. Repeat steps 7 through 14 for all of the additional points that are needed.

7. Press  to scroll to the desired point. *Point X* displays.
8. Press . *Percent Capacity X* displays.
9. Press . The current percent capacity for the point displays.
10. Enter a new percent capacity value for the point with the keypad, if necessary.
11. Press . *Correction Factor X* displays.
12. Press . The current correction Factor value for the point displays.
13. Enter a new correction Factor value for the point with the keypad, if necessary. ([Section 5.2.4.1 on page 54](#))
14. Press . *Percent Capacity X* displays again.
15. Repeat steps 7 through 14 for additional points as needed or press  to return to the weigh mode.

5.2.4.1 Correction Factor

The Correction Factor adjusts the span value to correct for dynamic loading at the weigh frame. After completing a zero and span calibration, material tests as a percentage of *Max Capacity* can be run to calculate correction factor values for each linearization point. It is recommended that at least three material tests must be ran for each linearization point and the calculated correction Factor values from these tests can then be averaged and used. This value can be adjusted manually



NOTE: When exiting to weigh mode, the calibration points are reorganized from lowest to highest Percent Capacity value.

The changeover point for each range is at the Percent Capacity for that point.

When a dynamic span calibration (one point) is performed, its Correction Factor applies to the entire range.

Max Capacity is the Rate, whenever referring to Percent Capacity this is the current Rate in respect to Max Capacity.

Calculation Example

For this example assume the belt scale has a total load cell build of 100 lb with a millivolt output of 3.0 mV and a max capacity of 180 tn/hr. Assume the belt is operating at a fixed speed of 60 ft/min and is fed by a hopper system that produces material at a rate up to 150 tn/hr. The current Correction Factor 1 value created by the previously run Span Calibration is 99.010871.

Table 5-1 shows example values for three linearization points. The following two equations correspond with the provided values:

- Calculated Correction Factor = (Actual Weight ÷ Registered Weight) x Current Correction Factor
Actual Weight = Real weight of material on the scale in tons
Registered Weight = The measured weight of material the 882D totalizer shows in tons
- New Correction Factor = (Calculated Correction Factor of Test 1 + Test 2 + Test 3) ÷ 3

For this example Correction Factor 1 is applied from 0.0 - 40.0%, Correction Factor 2 is applied from 40.1 - 70.0% and Correction Factor 3 is applied over 70.1%.

Linearization Point	Percent Capacity	Material Test Number	Actual Weight (tn)	Registered Weight (tn)	Current Correction Factor	Calculated Correction Factor	New Correction Factor
Point 1	Percent Capacity 1 40.0	Test 1	9.3	9.5	99.010871	96.926395	Correction Factor 1 98.272514
		Test 2	8.5	8.6	99.010871	97.859573	
		Test 3	9.8	9.7	99.010871	100.031574	
Point 2	Percent Capacity 2 70.0	Test 1	14.7	14.3	99.010871	101.780403	Correction Factor 2 100.318277
		Test 2	15.2	14.8	99.010871	101.686838	
		Test 3	12.8	13.0	99.010871	97.487589	
Point 3	Percent Capacity 3 100.0	Test 1	21.4	21.1	99.010871	100.418609	Correction Factor 3 99.238795
		Test 2	20.8	20.6	99.010871	99.972168	
		Test 3	23.1	23.5	99.010871	99.010871	

Table 5-1. Linearization Example

6.0 Using Revolution

The Revolution utility provides support for the 882D using a PC. Current support functions include saving and restoring configuration files, as well as updating the operating firmware. Additional functions will be made available in future releases.



NOTE: For system requirements visit www.ricelake.com/revolution

6.1 Connecting to the 882D

Communicating to the 882D can be accomplished three ways - using a serial connection to the serial (COM) port through J3; using a USB connection and Virtual Comm Port to the USB Micro Device (USBCOM) port through J4; or using a TCP/IP connection through the Ethernet Port (J6).

After making the physical connection to a PC, select **Options** in the Tools menu and configure the communications settings as needed to match the communications method being used:

- RS-232 and RS-485 – select the COM port that it will be connected to. Settings can be configured manually to match the current settings, or check the box for *Auto Detect Settings* to have Revolution automatically detect the settings.
- USB – select RS-232 as the communication mode. The USB connection appears as a standard COM port to Revolution. The comm port for the USB connection only displays in the list of available ports if it is physically connected and powered on. The settings for baud rate, data and stop bits, and parity do not apply for a USB connection, and do not need to be set to any specific value.
- TCP/IP – requires the IP address and TCP Port of the 882D. Enter the IP address and port during the communications connection.

To open the communication connection, click on **Connect** under the Communications menu, or the **Connect** button in the Toolbar. Revolution will attempt to establish communications with the 882D.



NOTE: If Revolution does not detect the 882D, check:

- * *Physical connections*
- * *Communications settings in Revolution*
- * *Current settings of the communications port in the 882D*
- * *882D communications port Trigger parameter is set to Command*
- * *If Revolution displays a Version Error, the 882D version of firmware does not match the module used in Revolution. A connection can be forced, but some parameters may not be enabled if they were not originally supported in that module.*

6.2 Saving and Restoring Configuration Files

6.2.1 Uploading Configuration to Revolution

The **Get Configuration from Device** function in the Revolution Communications menu allows the existing configuration of a connected indicator to be saved to a file on the PC. Once saved, the configuration file provides a backup that can be quickly restored to the indicator if needed. Alternatively, the file can be edited within Revolution and sent back to the indicator.



NOTE: Uploading and downloading processes can take several minutes to complete.

6.2.2 Downloading to the 882D

The **Send Configuration to Device** function in the Revolution Communications menu allows a Revolution configuration file (with or without scale calibration data) or ticket formats to be sent/downloaded to a connected indicator in *Setup* mode.

The **Send Section to Device** function in the Revolution Communications menu allows download of only the currently displayed section, such as the communications port configuration.

Because less data is transferred using **Send Section to Device**, it is typically faster than a full configuration download, but there is an increased possibility that the download may fail due to dependencies on other objects. If the download fails, try performing a complete download using the **Send Configuration to Device** function.

6.3 Updating the 882D CPU Firmware

The firmware for the 882D CPU can be updated using a PC with a RS-232 serial port and the Revolution software package.



NOTE: ALL configuration data, including calibration, will be lost if updating the CPU firmware. Use Revolution to upload and save a copy of the current configuration before continuing (Section 6.2 on page 55). After updating, use Revolution to restore the configuration and calibration.

Firmware updates can only be done through the RS-232 port. Updates through the USB and Ethernet ports are not supported.

1. Download the new CPU firmware from www.ricelake.com.
CPU firmware file – 882D_CPU_Firmware_176769_Vx_xx_xx.S19



NOTE: File names are subject to change, but always contain some designation of the device they are intended for.

2. Connect the RS-232 Port (J3) from the CPU board (Section 2.4.7 on page 16) to a PC.
3. Remove the JP2 jumper and set aside until firmware update is completed successfully (Section 12.7 on page 98).



IMPORTANT: Replace the JP2 jumper when update is complete. Normal operation of the 882D will be affected if the JP2 jumper is not put back in place.

4. Press and hold the **SETUP** switch (Section 4.1 on page 27) while applying power to put the 882D into *BOOT* mode. The display is black for several seconds and then displays.
5. Release the setup switch.
6. Start the Revolution software on the PC.
7. Select **NEW** under the File menu.
8. Select the 882D module applicable for the current version of firmware.
9. Select **Options/Communications/AutoDetect** under the Tools menu.
10. Select the *Auto Detect Settings* check box and click **OK**.
11. Select **Connect** under the Communications menu. Revolution establishes communications with the 882D.



NOTE: Check the connections if communication with the 882D fails.

12. Once connected, select *Update CPU Firmware* in the main indicator information screen.
13. Select the file for the Firmware being updated.

The program proceeds to load new firmware. This may take several minutes. While in progress do not leave the Revolution window or interrupt power to the 882D. The progress of the download is indicated on the 882D Information screen.

When the download is complete, the program indicates if it was successful or not.



NOTE: If it was not successful, turn off the power to the 882D, return to [Step 4](#), and try the entire procedure again. If problems persist, contact Rice Lake Weighing Systems for technical assistance.

7.0 EDP Commands

The 882D can be controlled by a personal computer or terminal using EDP commands, which can access reporting and weigh mode information, query or set the value of configuration parameters, and simulate front panel key presses.

When processing an EDP command, the 882D will either respond with the value requested, or in cases where no value was requested, the message *OK* to verify that the command was received and executed. If the command is unrecognized or cannot be executed, the 882D responds with *??*.

7.1 Reporting Commands

Reporting commands are commands that report some data about the system. These commands can be used in both configuration mode and weigh mode.

Command	Function
AUDITJUMPER	Returns the state of the audit jumper; see Section 7.1.1
BUILD	Returns the date and time of the software build; see Section 7.1.2
DIN#s	Returns a numeric value representing the state of all the DIO bits for slots 0-2 (s); see Section 7.1.3 on page 58
DISPLAYBUILD	Returns the date and time of display module software build; "NONE" is returned if no display is found; see Section 7.1.4 on page 58
DISPLAYVERSION	Returns the current display module firmware version; "NONE" is returned if no display is found
DUMPALL	Returns a list of all parameter values
DUMPAUDIT	Returns a list of audit trail information; see Section 7.1.5 on page 58
DUMPCONFIG	Returns a list of all parameter values except for setpoint data
DUMPETH	Returns a list of all Ethernet parameter values
DUMPSC	Returns a list of all the scale related parameter values
DUMPSP	Returns a list of all setpoint parameter values
DUMPSVERSIONS	Returns the version information for CPU, display and option card(s)
FBTEST1	Returns the status of the respective option card in slot 1; see Section 7.1.6 on page 58
FBTEST2	Returns the status of the respective option card in slot 2; see Section 7.1.6 on page 58
HARDWARE	Returns a value that indicates which option cards are installed in the option slots; see Section 7.1.7 on page 59
OPTVERSION#s	Returns the firmware version for the attached option card in slot s; see Section 7.1.8 on page 59
P	Returns the currently displayed value with units identifier based on the mode; see Section 7.1.9 on page 59
Pn	Returns the currently displayed text on the message area line 1-3 (n); see Section 7.1.10 on page 59
VERSION	Returns the 882D software version, model number, and 4-digit software checksum value

Table 7-1. Reporting Commands

7.1.1 AUDITJUMPER

A response of *OK* indicates the jumper is in the **ON** position; A response of *??* indicates the jumper is in the **OFF** position.

7.1.2 BUILD

Returns the date and time of the software build.

Response: BUILD=MMM DD YYYY HH:MM:SS

7.1.3 DIN#s - Digital Input State

A value is returned that is the sum of all active bits, no matter how they are configured, for the specified slot.

Bit	Value	Bit	Value	Bit	Value
1	1	9	256	17	65536
2	2	10	512	18	131072
3	4	11	1024	19	262144
4	8	12	2048	20	524288
5	16	13	4096	21	1048576
6	23	14	8192	22	2097152
7	64	15	16384	23	4194304
8	128	16	32768	24	8388608

Table 7-2. Bit Values

Example: If bits 1 and 3 are active and all the rest are inactive, then the returned value would be 5.

7.1.4 DISPLAYBUILD

Returns the date and time of the display module software build.

Response: DISPLAYBUILD=MMM DD YYYY HH:MM:SS

7.1.5 DUMPAUDIT

Outputs an audit report. Example:

```
882D Audit Trail Report<CR><LF>
<current time and date><CR><LF>
Event 1 <time and date of event><CR><LF>
MAXCAPACITY=300.0<CR><LF>
Event 2 <time and date of event><CR><LF>
UID=stone<CR><LF>
MAXCAPACITY=400.0<CR><LF>
```

7.1.6 FBTEST1-2

This Anybus module test command can be used to test for the presence and functionality of the fieldbus carrier board and a connected Anybus module.

Command: FBTEST1 (Slot 1) or FBTEST2 (Slot 2)

Response: FBTEST1=<status> or FBTEST2=<status>

Where <status> =

NOTFOUND – fieldbus option card not found or not operational

NOMODULE – a fieldbus option card is installed but a fieldbus module was not found, is not a recognized module, or is not operational; the ID reported by the module will also be included
Example: "NOMODULE – 0x000"

MODBUS – a fieldbus option card is installed and an operational Modbus module was found

PROFIBUS – a fieldbus option card is installed and an operational Profibus module was found

ETHERNET_IP – a fieldbus option card is installed and an operational Ethernet IP module was found

DEVICENET – a fieldbus option card is installed and an operational DeviceNet module was found

PROFINET – a fieldbus option card is installed and an operational ProfiNet module was found

ETHERCAT – a fieldbus option card is installed and an operational EtherCAT module was found

7.1.7 HARDWARE

Returns codes representing the type of option card(s) installed. Response: `HARDWARE=xxx,yyy,zzz` – where xxx represents the on-board USB option (currently always 000), yyy represents slot 1 and zzz represents slot 2.

Possible values:

000 = none, 032 = 24-channel digital I/O card, 033 = 24Volt 8-channel DIO card, 085 = 4-channel relay card, 153 = analog output card, 170 = fieldbus card

Example response with a 4-channel relay card installed in slot 1 and an analog output card in slot 2:

`HARDWARE = 000,085,153`

7.1.8 OPTVERSION#s

Returns the firmware version of the card in slot s. Returns `NOCARD` if no option card is installed. Returns `UNSUPPORTED` if the firmware in the option card does not support the command.

7.1.9 P

Returns the currently displayed value including the units.

Data Description

For this section:

www – 9 character locations for weight including decimal and negative sign, leading spaces replace any unused locations; Negative value denoted by a '-' (hex 0x2d) placed immediately before the value

<sp> – space (hex 0x20)

uu – units label

<term> – configured terminator for the port

& – ampersand (hex 0x26)

: – colon (hex 0x3a)

<menu_heading> – the currently displayed menu header name

<parameter_value> – the currently displayed parameter value

<message> – a message displayed while in weigh mode

Weigh Mode

Response in weigh mode with nothing in message area: `wwwwwwwww<sp>uu<term>`

Value is right justified.

Response when there are characters in message area: `<message><term>`

Output message is left justified, no weight data output.

Example: `Version<term>`

Response if there is an overload: `&&&&&&<sp>uu<term>`

Response if there is an underload: `::::::::<sp>uu<term>`

Configuration Mode

Response when no parameter value is displayed: `<menu_heading><term>`

Menu heading output is left justified.

Response when a parameter value is displayed: `<parameter_value><term>`

Parameter value output is left justified, ignoring blinking cursor value.

7.1.10 Pn

Returns the requested line of currently displayed text from the message area. These commands work in all modes of operation.

P1 – Returns the text from line 1 of the message area (top)

P2 – Returns the text from line 2 of the message area (middle)

P3 – Returns the text from line 3 of the message area (bottom)

The response will always be verbatim with the text from the display and fixed at 20 characters, any unused locations are padded with spaces.

7.2 Weigh Mode Commands

The weigh mode commands transmit data to a data communications port on demand. All commands are valid in both weigh and setup modes unless noted otherwise.

Command	Function
CONSNUM	Set or query the consecutive number
DISPLAYMODE	Set or query the current weigh mode display screen
UID	Set or query the unit ID; value is alphanumeric, up to 16 characters
SD	Set or query the date; enter six-digit date using the year-month-day order specified for the DATEFMT parameter, using only the last two digits of the year
ST	Set or query the time; enter the time using 24-hour format
SX	Start serial port streaming on the connected port ¹²
SX#n	Start serial port streaming on port n ¹²⁴
EX	Stop serial port streaming on the connected port ¹²
EX#n	Stop serial port streaming on port n ¹²⁴
RS	Reset system; this is a soft reset; used to reset the 882D without resetting the configuration to the factory defaults.
S	Returns a single stream frame using the format configured for the connected port ²
MT	Returns the master totalizer value ²³
T1	Returns the totalizer 1 value ²³
T2	Returns the totalizer 2 value ²³
LD	Returns the load value ²³
SPD	Returns the speed value ²³
RATE	Returns the rate value ²³
RT1	Resets the totalizer 1 value
RT2	Resets the totalizer 2 value
XE	Returns a decimal representation of any error conditions
XEH	Returns a hexadecimal representation of any error conditions
1 – The stream related commands are only valid for ports configured to stream data (EDP.TRIGGER#p = STRLFT or STRIND) 2 – These commands are only valid in weigh mode 3 – For these commands, add the suffix “_V” to return the value without units (example: send RATE_V to return the rate without units) 4 – “n” represents the communications port (1=COM, 2=USBCOM, 3=Ethernet Server, 4=Ethernet Client)	

Table 7-3. Weigh Mode Commands

7.2.1 DISPLAYMODE Command

This command switches to the specified display mode weight screen.

DISPLAYMODE = x

Where x is one of the following:

- LOAD
- SPEED
- RATE
- TOTALIZER1
- TOTALIZER2
- MASTERTOTALIZER

Sending DISPLAYMODE without a value will return the current value.

7.2.2 Totalizer Value Reporting

Returns the respective totalizer value MT, T1 and T2.

Response: `wwwwwww<sp>uu<term>`

Where:

`wwwwwww` – value, includes leading spaces

`<sp>` – space (hex 0x20)

`uu` – units label, as determined by Totalizer Resolution parameter, 2 characters, right justified, leading space if necessary

`<term>` – configured terminator for the port

7.2.3 Load Value Reporting

Returns the current load value LD.

Response: `wwwwwww<sp>uuuu<term>`

Where:

`wwwwwww` – value, includes leading spaces

`<sp>` – space (hex 0x20)

`uuuuu` – units label (lb/ft or kg/m), as determined by Units parameter, 5 characters, right justified, leading space if necessary

`<term>` – configured terminator for the port

7.2.4 Speed Value Reporting

Returns the current speed value SPD.

Response: `wwwwwww<sp>uuuu<term>`

Where:

`wwwwwww` – value, includes leading spaces

`<sp>` – space (hex 0x20)

`uuuu` – units label (m/s or ft/m), as determined by Units parameter, 4 characters, right justified, leading space if necessary

`<term>` – configured terminator for the port

7.2.5 Rate Value Reporting

Returns the current speed value RATE.

Response: `wwwwwww<sp>uuu<term>`

Where:

`wwwwwww` – value, includes leading spaces

`<sp>` – space (hex 0x20)

`uuu` – units label, as determined by rate resolution parameter, 3 characters, right justified, leading space if necessary

`<term>` – configured terminator for the port

7.2.6 XE and XEH Error Code Output

The XE and XEH commands return a representation of any existing error conditions as described in [Table 7-4](#). If more than one error condition exists, the number returned is the sum of the values representing the error conditions. The XE command returns the value as a decimal representation and the XEH command returns the value as a hexadecimal representation.

XE Error Code (decimal)	Description	XEH Error Code (hexadecimal)
0	no errors	0x00000000
1	VIRGERR	0x00000001
2	PARMCHKERR	0x00000002
4	LOADCHKERR	0x00000004
8	PRINTCHKERR	0x00000008

Table 7-4. XE and XEH Error Codes

XE Error Code (decimal)	Description	XEH Error Code (hexadecimal)
16	ENVRAMERR	0x00000010
32	ENVRCERR	0x00000020
64	BATTERYERR	0x00000040
128	TCPERR	0x00000080
65536	ADPHYSICALERR	0x00010000
262144	EACCOVER	0x00040000
524288	STRINGERR	0x00080000
1048576	RESERVED_PF	0x00100000
2097152	RTCERR	0x00200000
4194304	MISSINGHWERR	0x00400000
8388608	CFGCONFLICTERR	0x00800000
16777216	UNRECOVERABLEERR	0x01000000

Table 7-4. XE and XEH Error Codes (Continued)



NOTE: TCPERR – TCP initialization was not completed in a timely manner (2.5 seconds). When this error is raised all TCP functionality is disabled.

7.3 Key Press Commands

Key press EDP commands simulate pressing the keys on the front panel of the 882D. These commands can be used in both setup and weigh mode. Several of the commands serve as “pseudo” keys, providing functions that are not represented by a key on the front panel.

Command	Function
KMENU	Press the Menu key
KZERO	In weighing mode, press the Zero key
KPRINT	In weighing mode, press the Print key
KCLR	Press the CLR (clear) key
KCLR CN	Reset consecutive number (pseudo key)
KLEFT	In menu mode, move left in the menu
KRIGHT	In menu mode, move right in the menu
KUP	In menu mode, move up in the menu
KDOWN	In menu mode, move down in the menu
KSAVE	In setup mode, saves current configuration (pseudo key)
KEXIT	In setup mode, saves current configuration then exits to weigh mode (pseudo key)
K0–K9	Press number 0 (zero) through 9
KDOT	Press the decimal point (.) (key)
KENTER	Press the Enter key

Command	Function
KLOCK	Lock specified front panel key; For example, to lock the Zero key, enter KLOCK=KZERO (pseudo key)
KUNLOCK	Unlock specified front panel key; For example, to unlock the Print key, enter KUNLOCK=KPRINT (pseudo key)
KDATE	Display date (pseudo key)
KTIME	Display time (pseudo key)
KESCAPE	Exits the selected parameter; Returns to weigh mode if a parameter is not selected (functions identical to the Menu key in menu mode) (pseudo key)
KSETPOINT	Press the Setpoint key
KMODE	Press the Mode key
KF1	Press the F1 key
KF2	Press the F2 key
KF3	Press the F3 key
KF4	Press the F4 key

Table 7-5. Key Press Commands

7.4 Batching Control Commands

Command	Function
BATSTART	Batch start – If the BATRUN digital input is active (low) or not assigned, the BATSTART command can be used to start or resume the batch program; If the BATRUN is inactive (high), the BATSART command resets the batch program to the first batch step
BATSTOP	Batch stop – Stops the batch program at the current batch step and turns off all associated digital outputs
BATPAUSE	Batch pause – Stops the batch program at the current step; All digital outputs set on by the current step are set off; The BATSTR digital input or BATSTART serial command can be used to restart the batch program at the current step
BATRESET	Batch reset – Stops the batch program and resets it to the first batch step; Run the BATRESET command after making weigh mode changes to the batch configuration
BATSTATUS	Batch status – Returns XYYY, where X = S (stopped), P (paused) or R (running); YYY = setpoint number

Table 7-6. Batching Control Commands

7.5 Calibration Commands

These commands are valid only in configuration mode.

7.5.1 Speed

Command	Function
SPEED.PERFORMSPEEDCAL#n	Performs the speed calibration calculations on pulse input n
SPEED.STARTSPEEDCAL#n	Starts the speed calibration process on pulse input n
SPEED.STOPSPEEDCAL#n	Stops the speed calibration process on pulse input n

Table 7-7. Speed Calibration Commands

7.5.2 Weigh Frame

Command	Function
SC.APPLYDYNAMICCAL#n	Calculates and applies a new correction Factor; the calibration weight is then totalized using the new correction Factor
SC.CALCULATEDYNAMICCAL#n	Calculates a new span error percent
SC.DYNAMICZERO#n	Performs the weigh frame dynamic zero calculations on scale n
SC.MULTICALPOINT#n	Select which dynamic span point is being calibrated; this must be sent before performing the other steps (not needed when performing a zero calibration)
SC.REJECTDYNAMICCAL#n	Totalizes the calibration weight using the existing correction Factor
SC.SPANCALDISTANCETRAVELED#n	Get the distance traveled by the belt during the calibration on scale n
SC.STARTDYNAMICCAL#n	Performs the weigh frame dynamic span calculations on scale n
SC.STATICZERO#n	Performs the weigh frame static zero calculations on scale n
SC.TEMPERRORPERCENT#n	Get the current calculated error
SC.TEMPTESTTOTALIZER#n	Get test totalizer value from the just-completed dynamic calibration

Table 7-8. Weigh Frame Calibration Commands



NOTE: The 882D only supports one scale. “n” at the end of a command represents the scale number.

7.6 RESETCONFIGURATION Command

The RESETCONFIGURATION command can be used in configuration mode to restore all configuration parameters to their default values.

This command is equivalent to using the Default function under the Version menu in the Configuration mode.



NOTE: Totalizer 1 and 2 are reset and load cell calibration settings are lost when RESETCONFIGURATION command is run.

7.7 Parameter Setting Commands

Parameter setting commands allow to query or change the current value for a particular configuration parameter.

Current configuration parameter settings can be queried in either configuration mode or weigh mode using the following syntax:

command<CR>

Most parameter values can be changed in configuration mode only; some setpoint parameters listed in [Table 7-18 on page 70](#) can be changed when in normal weigh mode.

Use the following command syntax when changing parameter values:

command=value<CR>

where *value* is the new value to assign to the parameter. Use no spaces before or after the equal (=) sign. If an incorrect command is typed in, the response is ??.

For example, to set the dead band parameter to 3, type:

SC.DEADBAND#1=3.0<CR>

For parameters with selectable values, enter the command and equal sign followed by a question mark:

command=?<CR>

to see a list of those values. The 882D must be in configuration mode to use this function.

7.7.1 Scale Menu

Menu	Command	Description
Amount per Pulse	SC.AMOUNTPERPULSE#n	The amount of material represented by each pulse of the digital output configured as TOTALIZERPULSE; <i>Settings: 0.1 (default), 0.2, 0.5, 1, 2, 5, 0.01, 0.02, 0.05, 0.1, 0.2, 0.5, 1, 2, 5</i>
Angle of Incline	SC.ANGLEOFINCLINE#n	The angle of the conveyor measured in degrees (°); <i>Enter value: 0.0 - 89.0, 0.0 (default)</i>
Auto Zero Track Band	SC.AUTOZTRKBN#n	This is the band around which auto zeroing will occur; Auto Zero cannot start until a Warm Up (if any) has been run; During the auto zero sampling and actual zero process, the zero annunciator will flash; If the weight moves out of the band, any in-progress zero is stopped/flushed; There will be verification that the "Auto Zero Track Maximum" has not been exceeded before starting the Auto Zero process; Percentage of max capacity; <i>Enter value: 0.0 - 100.0, 0.0 (default)</i>
Auto Zero Track Max	SC.AUTOZEROMAX#n	This is the maximum amount that can be auto zeroed; Percentage of max capacity; <i>Enter value: 0.0 - 100.0, 0.0 (default)</i>
Belt Length	SC.BELTLENGTH#n	The total length of the conveyor belt (ft or m); <i>Enter value: 1.0 - 99999.0, 500.0 (default)</i>
Chain Weight	SC.MCAL.CWp#n	The weight/length of a chain used for a dynamic span calibration (lb/ft or kg/m); For example: when configured for METRIC units and the Chain Weight value is 100 (100 kg/m) <i>Enter value: 0.0 - 9999.0, 0.0 (default)</i>
Confirm Zero	SC.CONFIRMZERO#n	Whether to prompt to confirm a zero operation; Applies to front panel zero key or digital input; <i>Settings:</i> <i>ON (default) = prompt for zero confirmation</i> <i>OFF = do no prompt and automatically accept the zero</i>
Linearization Point Calibration Factor	SC.MCAL.CFp#n	Adjusts the span value to correct for dynamic loading at the weigh frame; This value is computed during calibration but can be adjusted manually; A value of 100 is equivalent to no adjustment; <i>Enter value: 0.0 - 1000.0, 100.0 (default)</i>
Linearization Point Weight	SC.MCAL.Vp#n	The weight which the correction Factor for the linearization point p applies (lb/ft or kg/m); <i>Enter value: 0.0 - 999999.0, 0.0 (default)</i>
Dead Band	SC.DEADBAND#n	The 882D will not totalize the amount if the rate is within the dead band value; The rate must be above the specified percentage of the configured Max Capacity for totalization to occur; Also, while within the dead band value the reported rate is forced to 0; % of configured Max Capacity; <i>Enter value: 0.0 - 100.0, 0.0 (default)</i>
Digital Filter 1-3	SC.DIGFLTR1#n SC.DIGFLTR2#n SC.DIGFLTR3#n	Selects the digital filtering rate used to reduce the effects of mechanical vibration from the immediate area of the scale; Choices indicate the number of A/D conversions per update that are averaged to obtain the displayed reading, a higher number gives a more accurate display by minimizing the effect of a few noisy readings, but slows down the settling rate of the indicator; <i>Settings: 1, 2, 4 (default), 8, 16, 32, 64, 128, 256</i>
Filter Sensitivity	SC.DFSENS#n	Digital filter cutout sensitivity; Specifies the number of consecutive readings that must fall outside the Filter Threshold parameter before digital filtering is suspended; <i>Settings: 2OUT (default), 4OUT, 8OUT, 16OUT, 32OUT, 64OUT, 128OUT</i>

Table 7-9. Scales Commands

Menu	Command	Description
Filter Threshold	SC.DFTHR#n	Digital filter cutout threshold; Specifies the filter threshold, in display divisions; When a specified number of consecutive scale readings (Filter Sensitivity parameter) fall outside of this threshold, digital filtering is suspended; If NONE is selected, the filter is always enabled; <i>Settings: NONE (default), 2D, 5D, 10D, 20D, 50D, 100D, 200D, 250D</i>
Distance per Pulse	SPEED.DPP#x	This is the distance represented by each pulse from a speed sensor (ft or m); <i>Enter value: 0.0 - 99.0, 1.0 (default)</i>
Display Rate	SC.DSPRATE#n	Display update rate; Specifies the display update rate, in the number of 100-millisecond intervals between updates; <i>Enter value: 1 - 80, 1 (default)</i>
Dynamic Span Type (no menu item)	SC.DYNAMICSPANTYPE#n	The type of dynamic span calibration to be performed; <i>Settings: MATERIAL (default), CHAIN, TESTWEIGHT</i>
Speed Input Type	SC.SPEEDTYPE#n	Specifies how the system determines belt speed. <i>Settings:</i> <i>PULSE (default) - Determines belt speed from pulses of a connected speed sensor</i> <i>FIXED - A pre-determined belt speed is entered into the 882D during configuration</i> <i>PLC - A connected PLC provides the belt speed by setting the value of Setpoint 20</i> NOTE: When using either a Fixed belt speed or a PLC provided belt speed, there must also be digital I/O configured and enabled as BELTRUNNING or the belt speed will be considered 0 (zero) (see Section 4.6.6 on page 42).
Fixed Speed	SC.FIXEDSPEED#n	Specifies a fixed belt speed for the 882D; If a non-zero value is entered the 882D no longer calculates belt speed using the speed sensor (ft/m or m/s); <i>Enter value: 0.0 - 9999.0, 0.0 (default)</i>
Idler Spacing	SC.IDLERSPACING#n	Defines the spacing between the idlers (in or m); It determines the weighing surface (e.g. max lb/ft) of the belt scale; For example: with a total loadcell build of 500lbs and a 4ft idler spacing the max lb/ft value is 125; <i>Settings: 0.01 - 9999.0, 48.0 (default)</i>
Load Resolution	SC.LOADRESOLUTION#n	The resolution for the load value; <i>Settings: 0.1 (default), 0.2, 0.5, 1, 2, 5, 0.01, 0.02, 0.05</i>
Material Weight	SC.MCAL.MWp#n	The actual amount of material used for a material based dynamic span calibration (tn or t); <i>Enter value: 0.0 - 9999.0, 0.0 (default)</i>
Max Capacity	SC.MAXCAPACITY#n	Defines the maximum rated capacity for the belt scale (the maximum amount of weight) that can pass along the belt scale per hour (tn/h, lb/h, t/h or kg/h); <i>Enter value: 0.1 - 99999.0, 500.0 (default)</i>
Millivolt Output	SC.MVV#n	<i>The average mV/V rating of all the load cells in the system; Enter value: 0.0 - 4.5, 3.0 (default)</i>
Negative Totalizing	SC.NEGATIVETOTALIZE#n	Specifies whether to allow values to be totalized when load value is negative, causing value to be subtracted from totalizers; <i>Settings: YES (default), NO</i>
Number of Idlers	SC.NUMBEROFIDLERS#n	Defines the number of idlers in the weigh frame; <i>Enter value: 1 - 4, 1 (default)</i>
Pulse Input	SC.PULSEINPUT#n	Specifies the pulse input scheme used for speed determination and error detections <i>Settings:</i> <i>SINGLE (default) – speed is determined from a single sensor connected to pulse input 1</i> <i>REDUNDANT – a single sensor going to both of the pulse inputs</i> <i>DUAL – two sensors each going to an individual pulse input</i>
Pulse Per Revolution	SPEED.PPR#x	The number of pulses output from the speed sensor per revolution; <i>Enter value: 0.0 - 99999.0, 60.0 (default)</i>
Pulse Width	SC.PULSEWIDTH#n	Defines how long the TOTALIZERPULES digital output stays on (ms); <i>Enter value: 0 - 1000, 250 (default)</i>
Rate Dampening (seconds)	SC.RATEDAMPSECONDS#n	The number of seconds to average rate values; A value of 0 turns off the averaging; <i>Enter value: 0 - 600, 0 (default)</i>
Rate Dampening (sensitivity)	SC.RATEDAMPSENS#n	The number of consecutive rate value calculations that must fall in or out of the threshold value before rate filtering is suspended/resumed; <i>Enter value: 0 - 400, 50 (default)</i>
Rate Dampening (threshold)	SC.RATEDAMPTHRESH#n	The rate threshold used with sensitivity to set where rate filtering is suspended/resumed; <i>Enter value: 0 - 1000, 200 (default)</i>
Rate Resolution	SC.RATERESOLUTION#n	The resolution for the rate value; <i>Select value: see Figure 4-8 on page 33</i>
Ratio	SC.RATIO#n	The lever ratio for a pivoted weigh frame; <i>Enter value: 0.0 - 9999.0, 1.0 (default)</i>
RattleTrap	SC.RATLTRAP#n	Enables or disables the RattleTrap filter setting; <i>Settings: ON, OFF (default)</i>
Sensor Diameter	SPEED.DIAMETER#n	The diameter of the speed sensor (in or m); <i>Enter value: 0.01 - 100.0, 3.81972 (default)</i>
Sample Rate	SC.SMPRAT#n	Analog-to-digital converter sample rate; Selects measurement rate, in samples per second, of the analog-to-digital converter; <i>Settings: 30HZ (default), 60HZ, 120HZ, 7.5HZ, 15HZ</i>

Table 7-9. Scales Commands (Continued)

Menu	Command	Description
Span Error Percent	SC.MCAL.SEp#n	The difference between the user entered amount and the monitored amount is calculated as a percentage of the user entered amount; When a dynamic span calibration is performed the stored percentage and the new percentage are shown to the operator who can then decide whether or not to accept the calibration; <i>Enter value: -999.0 - 999.0, 0.0 (default)</i>
Speed Cal Type (no menu item)	SPEED.SPEEDCALTYPE#x	The type of calibration used to calculate belt speed; <i>Settings: CALCULATED (default), REVOLUTIONS, DISTANCE</i>
Test Distance	SPEED.TESTDISTANCE#x	The user provided distance the belt traveled during a speed calibration (ft or m); <i>Enter value: 0.0 - 99999.0, 0.0 (default)</i>
Test Revolutions	SPEED.TESTREVOLUTIONS#x	The user provided number of revolutions the belt made during a speed calibration; <i>Enter value: 0.0 - 99999.0, 1.0 (default)</i>
Test Weight	SC.MCAL.TWp#n	The amount of test weight used for a test weight based dynamic span calibration (lb or kg); <i>Enter value: 0.0 - 99999.0, 0.0 (default)</i>
Totalizer Resolution	SC.TOTALIZERRESOLUTION#n	The resolution for the totalizer value; <i>Select value: see Figure 4-8 on page 33</i>
Total Loadcell Build	SC.TOTALLOADCELLBUILD#n	Total load cell capacity for all the load cells in system; e.g. in a system with 8 load cells, each having a capacity of 100, the total capacity would be 800 (lb or kg); <i>Enter value: 0.0 - 99999.0, 500.0 (default)</i>
Units	SC.UNITS#n	Specifies general units group used – either Metric or Imperial; <i>Settings: IMPERIAL (default), METRIC</i>
Warmup	SC.WARMUP#n	The Warmup timeout is started once speed is detected at power up; If speed drops to 0 or 882D enters setup mode, the warmup timer stops; The warmup timer restarts once the speed is above 0 and the 882D is in weigh mode; The parameter for warmup represents minutes, a setting of 0.0 disables warmup; If the Rate or Load is being displayed while warmup is active: <ul style="list-style-type: none"> • Message area displays "Warm Up" • No annunciators are displayed • Dashes fill numeric area Modes other than Rate or Load display normally while warmup is active; <i>Enter value: 0.0 - 60.0, 0.0 (default)</i>
Zero Error Percent	SC.ZEROERRORPERCENT#n	Percentage of the configured scale capacity that was run across the scale during a dynamic zero calibration; When a dynamic zero calibration is performed the stored percentage and the new percentage are displayed to the operator who can then decide whether or not to accept the calibration; <i>Enter value: -999.0 - 999.0, 0.0 (default)</i>
Zero Band	SC.ZEROBAND#n	This is the range that is used to determine whether the weight is zero; Zero band represents a percentage of Max Capacity; When weight is within the Zero Band, the Center of Zero (->0<-) annunciator will be displayed; Zero Band cannot be set above 2% in legal for trade applications; <i>Enter value: 0.0 - 100.0, 0.0 (default)</i>
Zero Counts	SC.ZEROCOUNTS#n	This is the Zero (deadload) raw count value; This can be set manually or through calibration; <i>Enter value: -2147483646 - 2147483647, 0 (default)</i>
Zero Range	SC.ZRANGE#n	This is the total amount that can be zeroed off, either manually or summed with Auto Zero; A value of 0.0 prevents any zeroing; <i>Enter value: 0.0 - 100.0, 0.0 (default)</i>

Table 7-9. Scales Commands (Continued)



NOTE: "n" at the end of a command represents the scale number.

"p" within a command represents the calibration point number.

"x" at the end of a command represents the pulse input number.

7.7.2 Time and Date Menu

Menu	Command	Description
Time Format	TIMEFMT	Specifies whether time is in 12-hour or 24-hour format; <i>Settings: 12HOUR (default), 24HOUR</i>
Time Separator	TIMESEP	Specifies the time separator; <i>Settings: COLON (default), COMMA</i>
Date Format	DATEFMT	Specifies the date format; <i>Settings: MMDDY4 (default), DDMMY4, Y4MMDD, Y4DDMM, MMDDY2, DDMMY2, Y2MMDD, Y2DDMM</i>
Date Separator	DATESEP	Specifies the date separator; <i>Settings: SLASH (default), DASH, SEMI</i>

Table 7-10. Time and Date Commands

7.7.3 Passwords Menu

Menu	Command	Description
User	PWD.USER	Used to protect items in the top level menu; If value is zero, password is turned off; <i>Enter value: 0 - 999999, 0 (default)</i>
Setup	PWD.SETUP	Used to protect items in the setup menu; If value is zero, password is turned off; <i>Enter value: 0 - 999999, 0 (default)</i>
Totalizer	PWD.TOTALIZER	Used to protect Totalizers 1 and 2 from being cleared from the weigh mode; If value is zero, password is turned off; <i>Enter value: 0 - 999999, 0 (default)</i>

Table 7-11. Password Commands



NOTE: The EDP commands can be used to set the passwords but they will not return the current password setting.

7.7.4 Features Menu

Menu	Command	Description
Consecutive Number Current Value	CONSNUM	Query or set the current consecutive number value; The consecutive number value is incremented following each print operation that includes <CN> in ticket format; <i>Enter value: 0 - 999999, 0 (default)</i>
Consecutive Number Reset Value	CONSTUP	Specifies the value used when the consecutive number is reset by sending the KCLRCN serial command or a CLRCN digital input; <i>Settings: 0 - 999999, 0 (default)</i>
Decimal Format	DECfmt	Specifies whether decimal numbers are displayed using a period (DOT) or comma as the decimal symbol; <i>Settings: DOT (default), COMMA</i>
Unit ID	UID	Specifies the unit identification string; <i>Alphanumeric, Max Length: 16, 1 (default)</i>
CLR TOTAL 1 W/ PRINT	CLEARTOTAL1WITHPRINT	If YES, then the Totalizer 1 value is cleared when a print is performed; If NO, then the Totalizer 1 value is not cleared when a print is performed; <i>Settings: NO (default), YES</i>
CLR TOTAL 2 W/ PRINT	CLEARTOTAL2WITHPRINT	If YES, then the Totalizer 2 value is cleared when a print is performed; If NO, then the Totalizer 2 value is not cleared when a print is performed; <i>Settings: NO (default), YES</i>
AUDIT PRINT PORT	AUDITPRINTPORT	The port that an audit report is transmitted out of; <i>Settings: COM (default), USBCOM, ETH-C, ETH-S, OFF</i>

Table 7-12. Features Commands

7.7.5 Ports – COM Menu

Menu	Command	Description
Baud	EDP.BAUD#1	Port baud rate; <i>Settings: 9600 (default), 19200, 28800, 38400, 57600, 115200, 1200, 2400, 4800</i>
Bits	EDP.BITS#1	Port data bits and parity; <i>Settings: 8NONE (default), 7EVEN, 7ODD</i>
Echo	EDP.ECHO#1	Specifies whether characters received by the port are echoed back to the sending unit; <i>Settings: ON (default), OFF</i>
End of Line Delay	EDP.EOLDLY#1	Port end-of-line delay in 0.1 second intervals; <i>Enter value: 0-255, 0 (default)</i>
Type	EDP.TYPE#1	Specifies RS-232, RS-485 or RS-422 communications; If 485 is selected then the ADDRESS parameter is shown in the menu; <i>Settings: 232 (default), 485, 422</i> Note: When changing between RS-232 and RS-485/RS-422, switch SW3, on the CPU board, must also be changed; See Section 2.4.7 on page 16
Address	EDP.ADDRESS#1	Specifies decimal indicator address for RS-485 connections; RS-485 addresses must be 01-255; <i>Enter value: 0-255, 0 (default)</i>
Print Message	EDP.PRNMSG#1	Displays a message when a print is transmitted; <i>Settings: ON (default), OFF</i>
Response	EDP.RESPONSE#1	Specifies whether the port transmits replies to serial commands; If an external device (such as a printer) that may transmit unexpected data (such as a paper low message) is connected to the 882D the response parameter should be set to OFF to prevent a reply from the 882D from confusing the external device; <i>Settings: ON (default), OFF</i>
Stream Format	EDP.SFMT#1	Specifies the stream format used for streaming output of scale data or specifies the expected input for a serial scale; <i>Alphanumeric, Max Length: 200, <R><NL> (default)</i> ; See Section 12.4.1 on page 94
Stop Bits	EDP.STOPBITS#1	Selects the number of stop bits transmitted and the number of stop bits expected to be received by the port; <i>Settings: 1 (default), 2</i>
Termination	EDP.TERMIN#1	Selects the termination character(s) for data sent from the port; <i>Settings: CR/LF (default), CR</i>

Table 7-13. PORTS (COM) Commands

Trigger	EDP.TRIGGER#1	Selects the operation of the port; Settings: COMAND (default) – allows operation of EDP commands and will print STRLFT – stream legal for trade scale data; weight data in the stream frame is updated at the configured display update rate; will also accept EDP commands; the 882D will not stream if port type is set for 485 STRIND – stream industrial scale data; weight data in the stream frame is updated at the configured sample rate; will also accept EDP commands; the 882D will not stream if port type is set for 485 PROGIN – programmable input; for use with an iRite user program
---------	---------------	---

Table 7-13. PORTS (COM) Commands (Continued)

7.7.6 Ports – USBCOM Menu

Menu	Command	Description
Echo	EDP.ECHO#2	Specifies whether characters received by the port are echoed back to the sending unit; Settings: ON (default), OFF
End of Line Delay	EDP.EOLDLY#2	Port end-of-line delay, in 0.1 second intervals; Enter value: 0-255, 0 (default)
Print Message	EDP.PRMSG#2	Displays print message; Settings: ON (default), OFF
Response	EDP.RESPONSE#2	Specifies whether the port transmits replies to serial commands; If an external device (such as a printer) that may transmit unexpected data (such as a paper low message) is connected to the 882D, the response parameter should be set to OFF to prevent a reply from the 882D from confusing the external device; Settings: ON (default), OFF
Stream Format	EDP.SFMT#2	Specifies the stream format used for streaming output of scale data (TRIGGE = STRLFT or STRIND); Alphanumeric, Max Length: 200, <R><NL> (default); See Section 12.4.1 on page 94
Termination	EDP.TERMIN#2	Selects the termination character(s) for data sent from the port; Settings: CR/LF (default), CR
Trigger	EDP.TRIGGER#2	Selects the operation of the port; Settings: COMAND (default) – allows operation of EDP commands and prints STRLFT – stream legal for trade scale data; weight data in the stream frame is updated at the configured display update rate; also accepts EDP commands STRIND – stream industrial scale data; weight data in the stream frame is updated at the configured sample rate; also accepts EDP commands PROGIN – programmable input; for use with an iRite user program

Table 7-14. PORTS – USBCOM Commands

7.7.7 Ports – Ethernet Menu

Menu	Command	Description
Default Gateway	ETH.DEFAULTGATEWAY	Default gateway; Valid IP address, 000.000.000.000 (default)
DHCP	ETH.DHCP	Dynamic Host Configuration Protocol; Settings: ON (default), OFF
DNS Primary	ETH.DNSPRIMARY	Primary DNS server IP address; Valid IP address, 000.000.000.000 (default)
DNS Secondary	ETH.DNSSECONDARY	Secondary DNS server IP address; Valid IP address, 000.000.000.000 (default)
IP Address	ETH.IPADDRESS	IP address for the device; If DHCP is enabled this IP address is automatically set; Valid IP address, 192.168.000.001 (default)
MAC	ETH.MACADDRESS	MAC address (read only); Settings: n/a – read only
Netmask	ETH.NETMASK	Specifies the netmask; Valid IP address, 000.000.000.000 (default)
Client Echo Server Echo	ETH.CLIENT.ECHO ETH.SERVER.ECHO	Specifies whether characters received by the port are echoed back to the sending unit; Applies to EDP command operation; Settings: OFF (default), ON
Client End of Line Delay Server End of Line Delay	ETH.CLIENT.EOLDLY ETH.SERVER.EOLDLY	Port end-of-line delay, in 0.1 second intervals; Enter value: 0-255, 0 (default)
Client Response Server Response	ETH.CLIENT.RESPONSE ETH.SERVER.RESPONSE	Specifies whether the port transmits replies to serial commands; If an external device (such as a printer) that may transmit unexpected data (such as a paper low message) is connected to the 882D, the response parameter should be set to OFF to prevent a reply from the 882D from confusing the external device; Settings: ON (default), OFF

Table 7-15. PORTS – Ethernet Commands

Menu	Command	Description
Client Remote IP Address	ETH.CLIENT.REMOTESERVERIP	Remote IP address of the remote machine that the 882D will connect to; <i>Valid IP address, 000.000.000.000 (default)</i>
Client Remote Port	ETH.CLIENT.REMOTESERVERPORT	Remote port number of the remote machine that the 882D will connect to; <i>Enter value: 1-65535, 1 (default)</i>
Client Stream Format Server Stream Format	ETH.CLIENT.SFMT ETH.SERVER.SFMT	Specifies the stream format used for streaming output of scale data (TRIGGE=STRLFT or STRIND); <i>Alphanumeric, Max Length: 200, <R><NL> (default)</i> ; See Section 12.4.1 on page 94
Client Termination Server Termination	ETH.CLIENT.TERMIN ETH.SERVER.TERMIN	Selects the termination character(s) for data sent from the port; <i>Settings: CR/LF (default), CR</i>
Client Timeout Server Timeout	ETH.CLIENT.TIMEOUT ETH.SERVER.TIMEOUT	Inactivity disconnect timeout; Connection is closed after a specified period (in seconds) of inactivity; Setting the value to 0 disables the parameter; <i>Enter value: 0 - 65535, 0 (default)</i>
Client Trigger Server Trigger	ETH.CLIENT.TRIGGER ETH.SERVER.TRIGGER	Selects the operation of the port; <i>Settings:</i> <i>COMAND (default) – allows operation of EDP commands and prints</i> <i>STRLFT – stream legal for trade scale data; weight data in the stream frame is</i> <i>updated at the configured display update rate; also accepts EDP commands</i> <i>STRIND – stream industrial scale data; weight data in the stream frame is</i> <i>updated at the configured sample rate; also accepts EDP commands</i> <i>PROGIN – programmable input, for use with an iRite user program</i>
Server Port	ETH.SERVER.PORT	Port that the 882D uses for its server; <i>Enter value: 1 - 65535, 10001 (default)</i>

Table 7-15. PORTS – Ethernet Commands (Continued)

7.7.8 Ports – Fieldbus Menu

Menu	Command	Description
Swap	FB.BYTESWAP#n	Specifies byte-swapping used for the fieldbus card; <i>Settings: NONE (default), BYTE, BOTH</i>
Address (DeviceNet)	FB.DEVICENETADDRESS#n	Specifies the DeviceNet address; <i>Enter value: 1 - 64, 63 (default)</i>
Address (Profibus)	FB.PROFIBUSADDRESS#n	Specifies the Profibus address; <i>Enter value: 1 - 126, 126 (default)</i>
Size	FB.SIZE#n	Specifies the data size, in bytes, that the BusCommand handler transfers; If this parameter is set to a value other than the default (8 bytes), ensure that it matches the Scanner I/O data size specified for the PLC; <i>Enter value: 2 - 128, 8 (default)</i>

Table 7-16. PORTS – Fieldbus Commands

7.7.9 Keypad Lock Menu

Menu	Command	Description
CLR	KEYLCK.CLR	Locks or unlocks the Clear key; <i>Settings UNLOCK (default), LOCK</i>
DOT	KEYLCK.DOT	Locks or unlocks the Dot key; <i>Settings UNLOCK (default), LOCK</i>
F1	KEYLCK.F1	Locks or unlocks the F1 key; <i>Settings UNLOCK (default), LOCK</i>
F2	KEYLCK.F2	Locks or unlocks the F2 key; <i>Settings UNLOCK (default), LOCK</i>
F3	KEYLCK.F3	Locks or unlocks the F3 key; <i>Settings UNLOCK (default), LOCK</i>
F4	KEYLCK.F4	Locks or unlocks the F4 key; <i>Settings UNLOCK (default), LOCK</i>
MODE	KEYLCK.MODE	Locks or unlocks the Mode key; <i>Settings UNLOCK (default), LOCK</i>
MENU	KEYLCK.MENU	Locks or unlocks the Menu key; <i>Settings UNLOCK (default), LOCK</i>
NUM	KEYLCK.NUM	Locks or unlocks the Numeric keys; <i>Settings UNLOCK (default), LOCK</i>
PRINT	KEYLCK.PRINT	Locks or unlocks the Print key; <i>Settings UNLOCK (default), LOCK</i>
SETPPOINT	KEYLCK.SETPOINT	Locks or unlocks the Setpoint key; <i>Settings UNLOCK (default), LOCK</i>
ZERO	KEYLCK.ZERO	Locks or unlocks the Zero key; <i>Settings UNLOCK (default), LOCK</i>

Table 7-17. Keypad Lock Commands

7.7.10 Setpoints Menu

Menu	Command	Description
Access	SP.ACCESS#n	Specifies the access allowed to setpoint parameters shown by navigating to the top level SETPT menu; <i>Settings:</i> OFF (default) – values can be displayed but not changed ON – values can be displayed and changed
Batch Sequence	SP.BATSEQ#n	Specifies whether the setpoint is used as a batch (ON) or continuous (OFF) setpoint; <i>Settings:</i> OFF (default), ON
Digital Output	SP.DIGOUT#n	This parameter is used to specify the digital output bit associated with this setpoint; Use the DIGIO menu to assign bit function to OUTPUT, only bits set as OUTPUT can be assigned to a setpoint; For continuous setpoints, the digital output becomes active (low) when the condition is met; for batch setpoints, the digital output is active until the setpoint condition is met; <i>Settings:</i> BIT1 (default), BIT2 - BIT24
Enable*	SP.ENABLE#n	Enables (ON) or disables (OFF) the setpoints; <i>Settings:</i> ON (default), OFF NOTE: The Enable menu item is only available in the top level setpoint menu
Selection made directly after dropping down from SETPT x	SP.KIND#n	Supported setpoint kinds; <i>Settings:</i> OFF (default) – setpoint turned off/ignored RATE – rate setpoint; performs functions based on the current rate %RATE – percent rate setpoint; performs functions based on a specified percentage of configured Max Capacity LOAD – load setpoint; performs functions based on current load SPEED – speed setpoint; performs functions based on current belt speed TOTAL – totalizer setpoint; performs functions based on totalizer value CELLMV – load cell millivolt setpoint; performs functions based on current cell mV reading PAUSE – pauses batch sequence indefinitely; a BATSTRT signal must be initiated to continue batch process DELAY – delays batch sequence for a specified time; the length of the delay (in tenths of a second) is specified on the VALUE parameter
Name	SP.NAME#n	Setpoint name string; Alphanumeric, Max Length: 6, "blank" (default)
Preact	SP.PREACT#n	Allows the digital output associated with a setpoint to shut off before the setpoint is satisfied to allow for material in suspension; <i>Settings:</i> OFF (default) – disables the preact ON – adjusts setpoint trip value up or down (depending on the TRIP parameter setting) from the setpoint value using a fixed value specified on the PREVAL parameter; weight based, e.g. a value of 2 = turn off 2 tons early LEARN – monitors the load amount on the specified distance of belt and adjusts the setpoint trip value up or down (depending on the TRIP parameter setting); for example a value of 15 ft (and a current load of 20 lb/ft) will turn off 0.08 tons early; 20 lb x 15 ft = 300 lb, 300 lb = 0.08 tons
Preact Value	SP.PREVAL#n	Specifies preact value for setpoints with PREACT set to ON or LEARN; depending on the TRIP setting specified for the setpoint, the setpoint trip value is adjusted up or down by the PREVAL value; <i>Enter value: 0-999999, 0 (default)</i>
Push Print	SP.PSHPRINT#n	Specifies which print format to transmit or none; <i>Settings:</i> NONE (default), PRINT FORMAT 1 - 4
Sense	SP.SENSE#n	Specifies whether the value of the digital output associated with this setpoint is inverted when the setpoint is satisfied; <i>Settings:</i> NORMAL (default), INVERTED
Slot	SP.DSLOT#n	Lists all available digital I/O slots; this parameter specifies the slot number of the digital I/O card referenced by the DIGOUT parameter; <i>Settings:</i> NONE (default) – specifies no digital output being used by the setpoint SLOT0 – onboard digital outputs; only shown if card is installed and at least one bit is configured as OUTPUT SLOT1 – digital I/O option card; only shown if card is installed and at least one bit is configured as OUTPUT SLOT2 – digital I/O option card; only shown if card is installed and at least one bit is configured as OUTPUT
Source	SP.SOURCE#n	The source for a TOTAL setpoint type; <i>Settings:</i> TOTALIZER 1 (default), TOTALIZER 2, MASTER
Trip	SP.TRIP#n	Specifies whether the setpoint is satisfied when the weight is higher or lower than the setpoint value; <i>Settings:</i> HIGHER (default) – the associated digital output is active until the setpoint value is reached or exceeded LOWER – the associated digital output is active until the current value goes below the setpoint value NOTE: For continuous setpoints, the digital output logic above is just the opposite

Table 7-18. Setpoints Commands

Menu	Command	Description
Value	SP.VALUE#n	Setpoint value; for time-based setpoints: specifies, in 0.1 second intervals, a time value; for all other setpoints: specifies the target value; <i>Enter value: 0 - 65535 (for the DELAY setpoint), 0 - 999999 (for the RATE, %RATE, LOAD, SPEED, TOTAL, CELLMV setpoints), 0 (default)</i>
Batching	BATCHNG	Set to MANUAL to allow a batch sequence to run; MANUAL requires a BATSTR digital input or BATSTART serial command before the batch sequence can run; <i>Settings: OFF (default), MANUAL</i>

Table 7-18. Setpoints Commands (Continued)



NOTE: Setpoint 20 is not available if the Speed Input Type is set to PLC (see [Section 4.6.1.1 on page 31](#)).



NOTE: “n” represents the setpoint number (1-20) for setpoint commands.

Different setpoint parameters are available and accepted depending on KIND, TRIP, and PRACT. These restrictions are listed below by the EDP command name but the same applies to access by menu.

RATE, %RATE, LOAD, SPEED, TOTAL, CELLMV type setpoints

SP.KIND#n=RATE, %RATE, LOAD, SPEED, TOTAL, CELLMV
 SP.ACCESS#n
 SP.BATSEQ#n
 SP.DIGOUT#n
 SP.ENABLE#n(EDP command is always available, menu item is only available in the top level menu)
 SP.NAME#n
 SP.PRACT#n(if KIND is TOTAL)
 SP.PREVAL#n(if PRACT is ON or LEARN only)
 SP.PSHPR#n
 SP.SENSE#n
 SP.SLOT#n
 SP.SOURCE#n(if KIND is TOTAL)
 SP.TRIP#n
 SP.VALUE#n

DELAY type setpoints

SP.KIND#n=DELAY and AUTJOG
 SP.ACCESS#n
 SP.CLRACM#n
 SP.CLRTAR#n
 SP.DIGOUT#n
 SP.ENABLE#n(EDP command is always available, menu item is only available in the top level menu)
 SP.NAME#n
 SP.PSHPR#n
 SP.SENSE#n
 SP.SLOT#n
 SP.VALUE#n

PAUSE type setpoints

SP.KIND#n=PAUSE
 SP.ACCESS#n
 SP.DIGOUT#n
 SP.ENABLE#n(EDP command is always available, menu item is only available in the top level menu)
 SP.NAME#n
 SP.SENSE#n
 SP.SLOT#n

7.7.11 Print Format Menu

The menu items are listed by the format and the sub-parameters.

- A press of Print (in run mode) prints Print Format 1. Entering a value and then pressing print will print the corresponding print format (2 + Print = Print Format 2).
- A setpoint Push Print can be configured to print any of the listed formats.

Menu	Command	Description
Print Format x Format	PFMTx.FMT	Alphanumeric, Max Length: 1000; Default: TIME: <T><NL>DATE: <DA><NL> MASTER TOTAL: <MT><NL>TOTAL: <T1><NL>RATE: <R><NL>
Print Format x Port COM	PFMTx.PORT.COM	Settings: ON (default), OFF
Print Format x Port USBCOM	PFMTx.PORT.USBCOM	Settings: OFF (default), ON
Print Format x Port ETH-S	PFMTx.PORT.ETH-S	Settings: OFF (default), ON
Print Format x Port ETH-C	PFMTx.PORT.ETH-C	Settings: OFF (default), ON

Table 7-19. Print Format Commands



NOTE: “x” represents the print format number (1-4).

See [Section 8.0 on page 77](#) for detailed information on print formatting.

7.7.12 Digital I/O Configuration Menu

Menu	Command	Description
BIT x	DIO.b#s	<p>OFF (default) – the digital I/O has no assigned function</p> <p>BATRUN – allows a batch routine to be started and run; with BATRUN active (low), the BATSTRT input starts the batch; if BATRUN is inactive (high), BATSTRT resets the batch</p> <p>BATSTR – starts or resets a batch routine, depending on the state of the BATRUN input</p> <p>BATPAS – pauses a batch routine</p> <p>BATRST – stops the batch sequence and resets to the first batch step</p> <p>BATSTP – stops a batch routine</p> <p>CLEAR – provides the same function as the front panel key</p> <p>CLRCN – resets the consecutive number to the value specified on the CONSTUP parameter</p> <p>CLRTOT1 – clears the Totalizer 1 value</p> <p>CLRTOT2 – clears the Totalizer 2 value</p> <p>BELTRUNNING – indicates whether or not the belt is running and whether to enable or disable totalization; input low = belt is running, enable the totalization; input high = belt is not running, disable the totalization; when this input indicates that the belt is not running, force the speed reading to zero regardless of speed input; if no digital input is configured as BELTRUNNING then the belt is determined to be moving or not moving based on whether or not pulses are being received from the speed sensor; only one BELTRUNNING input will be recognized; e.g. if both bit 3 and bit 4 are configured as BELTRUNNING then only the first one (bit 3) is used by the system</p> <p>INPUT – assigns the bit as a digital input used for the iRite GetDigin API</p> <p>KBDLOC – locks all the front panel keys while this input is held active</p> <p>MODE – provides the same function as the front panel key</p> <p>OUTPUT – assigns the bit as a digital output for setpoint or iRite program use</p> <p>PRINT – provides the same function as the front panel key</p> <p>PROGIN – assigns the bit as a digital input used to generate an iRite program event</p> <p>TOTALIZERPULSE – an output that pulses to indicate total material weighed</p> <p>ZERO – provides the same function as the front panel key</p>

Table 7-20. Digital I/O Configuration Commands



NOTE: Digital I/O are specified by bit number (b) and slot number (s).

7.7.13 Database Commands

The commands listed in [Table 7-21](#) can be used to create and maintain databases in the 882D. Except for the *DB.DELALL* command, all of the database commands require an extension to identify the database number.

Command	Description
DB.ALIAS.n#x	Get or set database name
DB.CLEAR.n#x	Clear database contents
DB.DATA.n#x	Get or set database contents
DB.SCHEMA.n#x	Get or set database structure
DB.DELALL	Delete all databases and database contents
	<ul style="list-style-type: none"> • <i>n</i> represents the database number, <i>x</i> is 0 • Each command must be terminated with a carriage return character (<CR>, ASCII 13) • The 882D only supports onboard databases - slot 0 • Onboard database number 1 is reserved for future use on the 882D; database numbers 2-9 are available

Table 7-21. Database Commands

DB.ALIAS

The *DB.ALIAS* command is used to get or set the alias used by *iRite* programs to reference the specified database. Each database alias must be unique among all databases and adhere to the following rules: 8 character maximum; must begin with an alpha character or an underscore; can only contain A–Z, a–z, 0–9, or an underscore (_).

Example. The following command assigns an alias of TRUCKS_2 to the second database in the onboard memory:

```
DB.ALIAS.2#0=TRUCKS_2<CR>
```

Sending the *DB.ALIAS* command alone, without assigned data, returns the current database alias.

DB.CLEAR

To clear the contents of a database, send the following command:

```
DB.CLEAR.n#x<CR>
```

Where:

n is the database number within the memory

x is the slot number 0

The 882D responds with *OK<CR>* if the command is successful, *??<CR>* if unsuccessful.

DB.DATA

The *DB.DATA* command can be used to send data to or retrieve data from the 882D.

Data can be sent to the 882D using the following command:

```
DB.DATA.n#x = data{ | }<CR>
```

Where:

n is the database number within the memory

x is the slot number 0

data represents a single cell of a row of data

{ | } is an ASCII pipe character (decimal 124), used to delimit cell data. If the data being sent is not the last cell of the row, append the pipe character to the data to indicate that more data is coming for that particular row. If the data being sent is the last cell of the row, do not append the pipe character.

If the command is accepted, the 882D responds with *OK<CR>*; if not, it responds with *??<CR>*.

Example: The following commands place the data shown in [Table 7-22](#) into the second database in the onboard memory:

```
DB.DATA.2#0=this|<CR>
```

```
DB.DATA.2#0=is|<CR>
```

```
DB.DATA.2#0=a|<CR>
```

```
DB.DATA.2#0=test<CR>
```

```
DB.DATA.2#0=aaa|<CR>
```

```
DB.DATA.2#0=bbb|<CR>
```

```
DB.DATA.2#0=ccc|<CR>
```

```
DB.DATA.2#0=ddd<CR>
```

Record	Cell			
	1	2	3	4
first	this	is	a	test
second	aaa	bbb	ccc	ddd

Table 7-22. Sample Database Contents

Sending the *DB.DATA* command alone, without assigned data, returns the database contents:

```
DB.DATA.n#x<CR>
```

The 882D responds with the entire contents of the database. Returned data is cell-delimited with the pipe character (decimal 124) and row-delimited with carriage returns (decimal 13).

For example, the following command could be used to return the contents of database 2 in the onboard memory:

```
DB.DATA.2#0<CR>
```

If the database contents are the records shown in [Table 7-22](#), the 882D responds with the following data, using pipe characters and carriage returns to delimit the database cells and rows, respectively:

```
this|is|a|test<CR>aaa|bbb|ccc|ddd<CR>
```



NOTE: There is not an end of database notification at the end of the *DB.DATA* command transmission. Use a receive time-out to determine command completion. The time-out value will vary based on baud rate.

Determine the number of records currently in the database both prior to and after sending the *DB.DATA* command to verify that the correct number of records are received. The number of records can be determined with the *DB.SCHEMA* command.



NOTE: The 62K of onboard (slot 0) memory can be allocated to up to eight auxiliary databases; however, the size of any one database may limit the size and number of other databases.

DB.SCHEMA

The *DB.SCHEMA* command is used to get or set the structure of a database.

DB.SCHEMA.n#x<CR>

The 882D responds to the command by returning the following:

*<Max Records>,<Current Record Count>,
<Column Name>,<Data Type>,<Data Size>,...<CR>*

The *<Column Name>*, *<Data Type>*, and *<Data Size>* elements repeat for each column in the database.

The *<Column Name>* follows the rules for alias names: 8 character maximum; must begin with an alpha character or an underscore; can only contain A–Z, a–z, 0–9, or an underscore (_).

The *<Data Type>* is represented by a numeric field:

Value	Type
1	Byte
2	Short (16-bit integer)
3	Long (32-bit integer)
4	Single (32-bit floating point)
5	Double (64-bit floating point)
6	Fixed string
7	Variable string
8	Date and time

Table 7-23. Data Type Field Codes

The *<Data Size>* value must match the data type. A range of data size values is allowed only for the string data types. The maximum number of characters allowed for the string field are listed below.

Size	Value
Byte	1
Short	2
Long	4
Single	4
Double	8
Fixed string	1–255
Variable string	1–255
Date and time	8

Table 7-24. Data Size Field Codes

The *DB.SCHEMA* command can also be used to modify the schema, but only when the 882D is in setup mode and only if the database does not contain any data.

7.7.14 Analog Output Menu

Menu	Command	Description
Source	ALG.SOURCE#s	Specifies the source of the analog output control; <i>Settings:</i> SCALE (default) indicates that the analog output will follow the configured Mode based on scale data PROG indicates that the analog output is under iRite program control
Mode	ALG.MODE#s	Specifies the data tracked by the analog output; source must be configured for SCALE for the analog output to follow any of these modes; <i>Settings:</i> RATE (default), SPEED, LOAD
Output	ALG.OUTPUT#s	Specifies the output type; this parameter must be set before calibrating the analog output; <i>Settings:</i> 0-10 V (default), 0-20 mA, 4-20 mA
Error Action	ALG.ERRACT#s	Specifies how the analog output responds to system error conditions; <i>Settings:</i> FULLSC (default) set to full value (10 V or 20 mA) HOLD current value ZEROSC set to zero value (0 V, 0 mA or 4 mA)
Minimum	ALG.MIN#s	Specifies the minimum value tracked by the analog output; <i>Enter value:</i> 0 - 999999, 0 (default)
Maximum	ALG.MAX#s	Specifies the maximum value tracked by the analog output; <i>Enter value:</i> 0 - 999999, 10000 (default)

Table 7-25. ALGOUT Commands



NOTE: “s” at the end of a command represents the slot number.

“n” at the end of the commands in the above table represent the channel for the analog output.

The 882D supports up to two single-channel analog output cards. An analog output card in slot 1 is referenced as analog output 1. An analog output card in slot 2 is referenced as analog output 3.

Settings from either analog output 1 or 3 will be accepted whether or not an analog output option card is installed in either slot.

7.7.15 Digital Output Control Commands

Command	Function
DON.b#s	Set digital output on (active) at bit b, slot s
DOFF.b#s	Set digital output off (inactive) at bit b, slot s

Table 7-26. Digital Output Control Commands



NOTE: Digital outputs are specified by bit number (b = 1-4 for slot 0, 1-24 for slots 1 and 2) and slot number (s = 0-2).

The DON/DOFF commands only control the state of a slot/bit that is defined as an OUTPUT in the configuration menu.

8.0 Print Formatting

The 882D provides four print formats. A press of the Print key in run mode prints Print Format 1. Entering a value and then pressing print, prints the corresponding print format (2 + Print = Print Format 2).

Each print format can be customized to include up to 1000 characters. Use the 882D front panel (PFORMAT menu), EDP commands, or the Revolution configuration utility to customize the print formats.



NOTE: The 882D only prints when not totalizing.

Each ticket printed includes a hard coded header that contains the Previous Zero Error Percent, the Current Error Percent, and the Current Master Total.

8.1 Print Formatting Tokens

Table 8-1 lists tokens that can be used to format the 882D print formats. Tokens included in the format strings must be enclosed in < > delimiters. Any characters outside of the delimiters are printed as text. Text characters can include any ASCII character that can be printed by the output device. See Section 12.3 on page 92.

Token	Description
<R>	The current rate with units included
<S>	The current speed with units included
<L>	The current load with units included
<MT>	Master Totalizer value – without units
<T1>	Totalizer 1 value – without units
<T2>	Totalizer 2 value – without units
<TU>	Totalizer units
<DT1>	Date of the last Totalizer 1 clear
<TT1>	Time of the last Totalizer 1 clear
<DT2>	Date of the last Totalizer 2 clear
<TT2>	Time of the last Totalizer 2 clear
<LPV1>	The last printed Totalizer 1 value
<LPV2>	The last printed Totalizer 2 value
<LPVM>	The last printed Master Totalizer value
<DCL1>	The difference between the current and the last printed Totalizer 1 value
<DCL2>	The difference between the current and the last printed Totalizer 1 value
<DCLM>	The difference between the current and the last printed Master Totalizer value
<SN>	Setpoint number; Valid when printed from a setpoint Push Print
<SNA>	Setpoint name; Valid when printed from a setpoint Push Print
<SPV>	Setpoint preact value; Valid when printed from a setpoint Push Print
<STV>	Setpoint target value; Valid when printed from a setpoint Push Print
<UID>	Unit ID number; Unit ID field is 1-16 characters in length, as required
<CN>	Consecutive number; Consecutive number (CN) field is 1-6 characters in length, as required
<TI>	Time
<DA>	Date
<TD>	Time & Date
<PFMT1> - <PFMT4>	Allows a print format to be used from another print format NOTE: A print format will ignore a token that would print itself Example: PFMT1.FMT=<R><PFMT1><CR> would literally print <PFMT1> when that token was encountered
<CR>	Carriage return character – hexadecimal 0x0D

Table 8-1. Print Tokens

Token	Description
<LF>	Line feed character – hexadecimal 0x0A
<FF>	Form feed character – hexadecimal 0x0C
<NLnn>	New line (nn = number of termination (<CR/LF> or <CR>) characters); If nn is not specified, 1 is assumed; Value must be in the range 1–99
<SPnn>	Space (nn = number of spaces); If nn is not specified, 1 is assumed; Value must be in the range 1–99
<SU>	Toggle weight data format (formatted/unformatted); After receiving an SU command, the 882D sends unformatted data until the next SU command is received; Unformatted data omits decimal points, leading and trailing characters
<WU>	Toggle weight data format (formatted/unformatted); After receiving a WU command, the 882D sends data without a units label until the next WU command is received; Unformatted data omits the units label
<USnn>	Insert user print text string (from iRite user program, SetPrintText API)
<EVx>	Invoke iRite user program print handler x (PrintFmtx); Range of x is 1-10
<nnn>	ASCII character (nnn = decimal value of ASCII character); Used for inserting control characters (STX, for example) in the print stream

Table 8-1. Print Tokens (Continued)



NOTE: Rate, speed, load, and totalizer values are 8 digits in length, including sign and decimal point, followed by a space and a one- to five-digit units identifier. Total field length with units identifier is 10-14 characters. Depending on the value and which units are configured (METRIC or IMPERIAL), the units identifier will be lb, kg, tn, t, lb/ft, m/s, etc.

8.2 Default Print Formats

Table 8-2 shows the default print formats for the 882D.

Format	Default Format String
Print Format 1-4	TIME: <T><NL>DATE: <DA><NL> MASTER TOTAL: <MT><NL>TOTAL: <T1><NL>RATE: <R><NL>
NOTE: If the COM port is set to TYPE = RS485, the port will not perform a demand print. See Section 12.4.4 on page 95 .	

Table 8-2. Default Print Formats

8.3 Customizing Print Formats

The following sections describe procedures for customizing print formats using the EDP commands, the front panel (PFORMAT menu), and the Revolution configuration utility.

8.3.1 Using the EDP Commands

The EDP command set can be used to customize the print format strings when a personal computer, terminal or remote keyboard are attached to the 882D.

To view the current setting of a format string, type the name of the print format, followed by .FMT, and press **ENTER**. For example, to check the current configuration of the *PFMT1* format, type *PFMT1.FMT* and press **ENTER**. The 882D responds by sending the current configuration for the print format:

```
TIME: <TI><NL>DATE: <DA><NL>MASTER TOTAL: <MT><NL>TOTAL: <T1><NL>RATE: <R><NL>
```

To change the format, put the 882D into setup mode and use the format EDP command followed by an equals sign (=) and the modified print format string.

For example, to add the name and address of a company to the print format, send the following EDP command:

```
PFMT1.FMT=RICE LAKE WEIGHING SYSTEMS<NL>230 W COLEMAN ST<NL>RICE LAKE WI 54868<NL2><T1> TOTAL<NL>
```

A ticket printed using this format might look like the following:

```
RICE LAKE WEIGHING SYSTEMS
230 W COLEMAN ST
RICE LAKE WI 54868
```

```
1345 T TOTAL
```

8.3.2 Using the Front Panel

If there is no access to equipment for communication through the communication ports or when working at a site where such equipment cannot be used, the Print Format menu ([Section 4.6.4 on page 39](#)) can be used to customize the print formats. Using the Print Format menu, edit the print format strings by changing the decimal values of the ASCII characters in the format string.

Edit the format using the Alphanumeric Entry Procedure. See [Section 4.3 on page 28](#).



NOTE: Some special characters cannot be displayed on the 882D front panel and are displayed as blanks. See the ASCII character chart on [page 92](#). The 882D can send or receive any ASCII character; the character printed depends on the particular ASCII character set implemented for the receiving device.

9.0 Ethernet

9.1 Ethernet Server/Client Connections

The 882D supports two simultaneous TCP connections, one as a server and the other as a client. This section details the functions of the Server and Client connections, including some examples on how they may be used. Refer to [Section 4.6.3 on page 37](#) for configuration.

Ethernet Server

The Server features a configurable TCP Port number. It also has settings for echo, response, End-of-Line delay, trigger function, timeout and stream data format.

A typical application may connect a PC Application (a *terminal program such as Telnet, or Revolution*) to the 882D.

The 882D listens for a connection request from an external client device.

Ethernet Client

The Client features the ability to open a TCP connection to a configurable Remote Server IP and TCP Port.

If a connection has not been made and the 882D attempts to send data through the client connection, it attempts to establish a connection to the remote server. It continues trying indefinitely until a connection is made.

Typical applications for the Client include connecting to:

- Ethernet printer or Remote Display
- Remote TCP to Serial device server
- PC application that is listening for the connection

The Client also has settings for echo, response, End-of-Line delay, trigger function, timeout, and stream data format.

Only a single connection each to the Server and Client is allowed at one time. If a connection is already established, other connection attempts fail.

- The Server and Client ports are independent of each other and both can have a connection at the same time. This means it can be streaming out one port, while using a PC to poll data from the other. Data can be streamed out both ports if desired.



IMPORTANT: For best results, set the End-of-Line Delay on both ports to at least 2.

- Establishing connections - a client must establish a connection to a server. Therefore, the 882D cannot connect to a Remote Client, and a Remote Server cannot connect to the 882D.
- Both the Server and Client connections have a Timeout parameter, allowing the 882D to terminate either connection after the set number of seconds has passed with no activity (0 = no disconnect).
- When connecting to a DHCP network, it may take several seconds before the 882D is assigned an IP address. When a new IP address is assigned through DHCP, it is stored in the 882D configuration and remains the IP address until reconfigured manually; the indicator settings are reset to default; or a new address is assigned by DHCP.

9.1.1 Direct Connection from a PC to the 882D Ethernet Server without a network (Ad-Hoc)

1. Use the computer's network configuration tools to configure the network adapter to have a static IP address and appropriate Netmask. The PC must be configured with a static IP address. *For example: 192.168.0.100.*
2. The 882D must also be configured with a static IP address, different from the computer's, but in the same Netmask.
3. Enter the configuration mode using the setup switch on the bottom of the 882D ([Figure 4-1 on page 27](#)).
4. Navigate to the Ethernet sub-menu under the Ports menu ([Section 4.6.3 on page 37](#)).
5. Set Dynamic Host Configuration Protocol (*DHCP*) to *OFF* and then configure the IP address and Netmask. Also set the Server Ethernet TCP Port number, if needed (default is 10001).

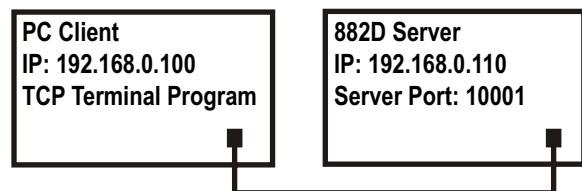

Figure 9-1. Direct Connection from PC to 882D Ethernet

6. Connect an Ethernet straight-through or crossover cable (the port is auto-sensing, so either will work) between the 882D and the Ethernet connector on the PC.
7. Open the PC application.
8. Enter the indicator's IP address and Server TCP Port number (*192.168.0.110 and 10001 in this example*) to establish the connection. The application now can communicate with the 882D using any of its EDP commands.

9.1.2 PC Connection to the 882D Ethernet Server Through a Network Switch or Router



NOTE: In some cases, devices cannot be connected to an existing network without the network administrator's approval. Ensure there is permission to connect to the network and seek help from the network administrator as needed.

1. Ensure the PC is connected to the network, and either assigned an IP address using DHCP, or have a static address.
 - If not, use the computer's network configuration tools to connect to the network.
 - If it is not a *DHCP* network, make note of the PC's IP Address and Netmask.
2. Enter the configuration mode using the setup switch on the bottom of the unit ([Figure 4-1 on page 27](#)).
3. Navigate to the Ethernet sub-menu under the Ports menu ([Section 4.6.3 on page 37](#)).

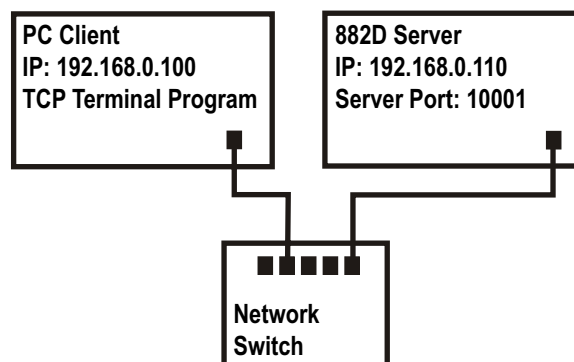

Figure 9-2. Connection from PC to 882D Ethernet Through a Network Switch or Router

4. Manually configure the 882D with a static IP address (recommended) or obtain its IP address using a DHCP (if supported on the network). Rice Lake Weighing Systems does not recommended using a DHCP because the scale IP address can change and communication will be lost.
 - Dynamic Host Configuration Protocol (DHCP): Set the DHCP Setting to ON. Set the Ethernet Server Port to the desired Port number (default is 10001). The IP, Netmask, Primary and Secondary DNS, and Default Gateway will be configured automatically when the 882D is connected to the DHCP-enabled network.
 - Manual (static) IP Address: Set DHCP to OFF. Configure the IP Address and Netmask. Also set the Ethernet Server Port number, if needed (default is 10001). Set the Primary and Secondary DNS, and Default Gateway, if needed.
5. Connect the Ethernet connector on the 882D to an available connector on the network using a straight-through or crossover cable (the port is auto-sensing, so either will work).
6. If connected to a DHCP-enabled network and *DHCP* is enabled, go back into the configuration mode and navigate to the IP setting to get the IP address the network assigned to the 882D. Make note of the current IP address, being careful not to change any of the numbers. Return to weigh mode.
7. Open the PC application to be used. To establish the connection, enter the indicator's IP address and Server TCP Port number (*192.168.0.110 - or the DHCP-assigned IP address - and 10001 in this example*). The application will now be able to communicate to the 882D using any of its EDP commands.

9.1.3 Connection to a Remote Server - Demand Print to an Ethernet Printer

1. Connect the 882D and printer directly to each other (each with a Static IP on the same Netmask) or through a network.
2. Configure the Client Remote Server IP and port to the IP address and TCP port of the printer.
3. Configure the port destination of the Print Format(s) being used to Ethernet Client (ETH-C).
4. Set the Ethernet Client Trigger to Command (COMAND) mode.
5. The Client attempts to connect to the printer if the client has not been connected and a demand print is called for. This may take several seconds. The print data will be sent to the printer once the connection is made.
6. The connection remains intact unless the 882D or the printer terminates the connection. The 882D has a timeout setting for the Client connection.
 - When set to 0, the connection is not terminated by the 882D.
 - When set to a value other than zero, the connection is terminated after inactivity for the specified period of time, in seconds.

The timeout feature is useful when several indicators want to print to the same printer.

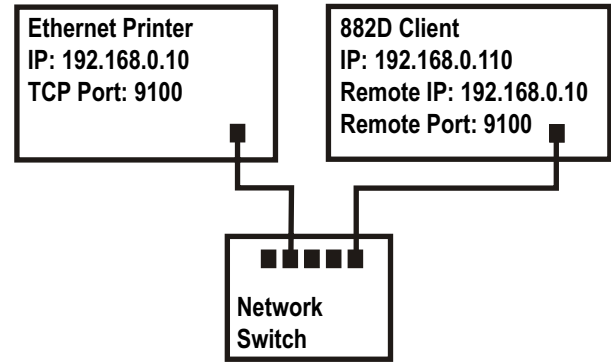

Figure 9-3. Connection to Remote Host

9.1.4 Connecting to a Remote Server - Stream weight data to an Ethernet Remote Display

1. Connect the 882D and Remote Display directly to each other (each with a Static IP on the same Netmask) or through a network.
2. Configure the Client Remote Server IP and port to the IP address and TCP port of the remote display.
3. Configure the trigger setting for the Client to either Stream Industrial (STRIND), or Stream Legal-for-Trade (STRLFT).
4. Rice Lake Weighing Systems recommends that the Client's End-of-Line Delay be set to 1 (10 frames per second) or 2 (5 frames per second) or higher to prevent data overrun on the receiving device (*the 882D streams data at up to 50 frames per second*). This is also a good way to help reduce network traffic if speed is not a concern. If data at the remote display appears to lag, or get behind the data on the indicator, the End-of-Line Delay may need to be increased even more.
5. The 882D starts to stream data to the Ethernet Client port shortly after returning to the weigh mode. The 882D then attempts to make the connection and data is sent to the Remote Host once connected. This may take several seconds.

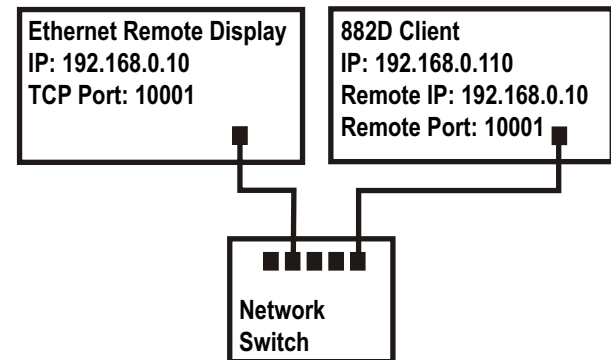

Figure 9-4. Connection to Remote Host to Stream

9.1.5 Connecting to a Remote Server, Stream/Demand Data to Remote Ethernet-to-RS-232 Device Server

1. Connect the 882D and device server directly to each other (each with a static IP on the same netmask) or through a network.
2. Configure the Client Remote Server IP and port to the IP address and TCP port of the device server.
3. Configure the trigger setting for the client to either command mode (COMAND), stream industrial (STRIND), or stream Legal-for-Trade (STRLFT), depending on the application.
4. Connect the serial output of the device server to the serial device set to send or receive data through the Ethernet connection.

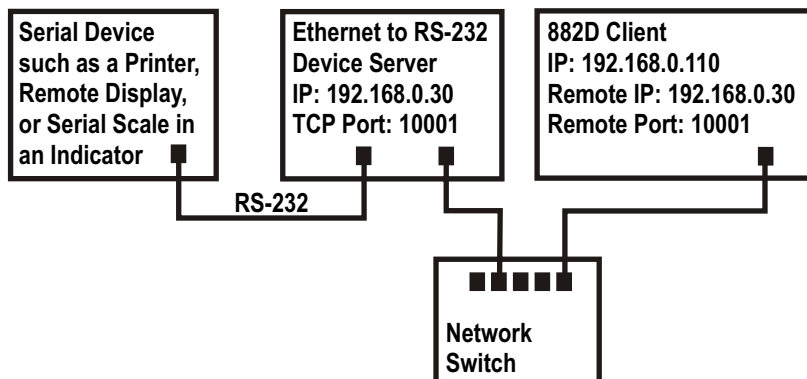

Figure 9-5. Stream or Demand Data to a Remote Ethernet to RS232 Device Server



NOTE: In this configuration, the 882D has to initiate the connection

Using Revolution with Ethernet

1. Use one of the methods shown in [Section 6.1 on page 55](#) to connect the 882D to the PC with Revolution installed.
2. In Revolution, after opening the 882D module, select **Tools**, then **Options**.
3. Set the default communications to TCP/IP and click **OK**.
4. Under the *Communications* menu, select **Connect**.
5. Revolution requests the IP address and port number. Enter them and click **OK**.
6. Revolution attempts to establish communications with the indicator. If the connection is successful, Revolution is ready for use to upload and download configuration settings.



NOTE: When using Revolution with Ethernet, the Timeout setting for the 882D Ethernet Server must be set to 0 to prevent the 882D from terminating the connection.

If the connection was unsuccessful, re-check all network settings on the computer and in the 882D. Attempt to ping the IP address of the 882D to verify the computer and 882D are both able to communicate on the network.

10.0 Setpoints

The 882D provides 20 configurable setpoints for control of both 882D and external equipment functions. Setpoints can be configured to perform actions or functions based on specified parameter conditions. Parameters associated with various setpoint kinds can, for example, be configured to perform functions (print and total), to change the state of a digital output to control external equipment functions, or to make conditional decisions.



NOTE: See [Section 4.6.5 on page 40](#) for setpoint menu layout.



NOTE: Setpoint 20 is not available if the Speed Input Type is set to PLC (see [Section 4.6.1.1 on page 31](#)).

10.1 Batch and Continuous Setpoints

882D setpoints can be either continuous or batch setpoints.

Continuous setpoints are free-running; the 882D constantly monitors the condition of free-running setpoints at each A/D update. The specified setpoint action or function is performed when the designated setpoint parameter conditions are met. A digital output or function assigned to a free-running setpoint continuously changes state, becoming active or inactive, as defined by the setpoint parameters.

Batch setpoints are active one at a time, in an ordered sequence. The 882D can use setpoints to control up to 20 separate batch processing steps.

- A digital output associated with a batch setpoint is active until the setpoint condition is met, then latched in an inactive state for the remainder of the batch sequence.
- To use batch setpoints, the Batching parameter in the Setpoints menu must be set to MANUAL. Batch sequences require a Batch Start signal each time a batch is run. The BATSTR signal can be initiated by a digital input, serial command,  or the StartBatch function in an iRite program.
- For setpoint kinds that can be used as either continuous or batch setpoints, the Batch Sequence parameter must also be set ON. (Setpoint kinds that can only be used as batch setpoints do not require the Batch Sequence parameter.) If setpoint is defined but Batch Sequence parameter is OFF, the setpoint operates as a continuous setpoint, even during batch sequences.

Kind	Description	Batch	Continuous
OFF	Setpoint turned off/ignored.	X	X
RATE	Rate setpoint. Performs functions based on the current rate.	X	X
%RATE	Percent rate setpoint. Performs functions based on a specified percentage of the configured Max Capacity.	X	X
LOAD	Load setpoint. Performs functions based on the current load.	X	X
SPEED	Speed setpoint. Performs functions based on the belt speed.	X	X
TOTAL	Totalizer setpoint. Performs functions based on the totalizer value.	X	X
CELLMV	Load cell millivolt setpoint. Performs functions based on the current cell mV reading.	X	X
PAUSE	Pauses the batch sequence indefinitely. A BATSTRT signal must be initiated to continue the batch process.	X	–
DELAY	Delays the batch sequence for a specified time. The length of the delay (in tenths of a second) is specified by the VALUE parameter.	X	–

Table 10-1. Setpoint Kinds

10.2 Batch Operations

Batches are controlled by digital inputs, EDP commands, the F1 (Start) and F2 (Stop) front panel switches, or iRite programs. For iRite control, please see the iRite programming manual (PN 67888).

Batch Run (BATRUN digital input) – If a BATRUN digital input is configured, it must be active (low) for a batch to be started and for it to continue to run. If a batch is running and the input becomes inactive (high), it stops the batch at the current batch setpoint and turn off all associated digital outputs.

Batch Start (BATSTR digital input, BATSTART EDP command, or F1 (Start) key) – If the BATRUN digital input is active (low), or is not assigned, batch start will start a batch, resume a paused batch or resume a stopped batch. If the BATRUN digital input is inactive (high), batch start resets the current batch.

Batch Pause (BASPAS digital input or BATPAUSE EDP command) – The BASPAS digital input pauses an active batch, turning off all associated digital outputs, while the input is active (low). As soon as the BASPAS digital input is made inactive (high), the batch resumes. BATPAUSE EDP command works the same as the BASPAS digital input, except the batch does not resume until a batch start signal is received.

Batch Stop (BATSTP digital input, BATSTOP EDP command, or F2 (Stop) key) – Stops an active batch at the current setpoint and turns off all associated digital outputs.

Batch Reset (BATRST digital input or BATRESET EDP command) – Stops and resets an active batch to the beginning of the process.



WARNING: Software-based interrupts must always be supplemented by emergency stop switches and other safety devices necessary for the application to prevent personal injury and equipment damage.

Batching Switch

The batching switch option, PN 19369, comes as a complete unit in an FRP enclosure, with legend plate, locking stop switch (mushroom button) and a run/start/abort 3-way switch.

Both switches are wired into the digital I/O terminal strip of the 882D as shown in Figure 10-1. Each switch uses a separate digital input. Digital input #1 must be set to *BATSTR* and #2 must be set to *BATRUN*.

Ensure cables and switches are connected to the 882D and then use the setup switch to place the 882D in configuration mode. Use the Digital I/O menu (Section 4.6.6 on page 42) to configure digital input and output functions.

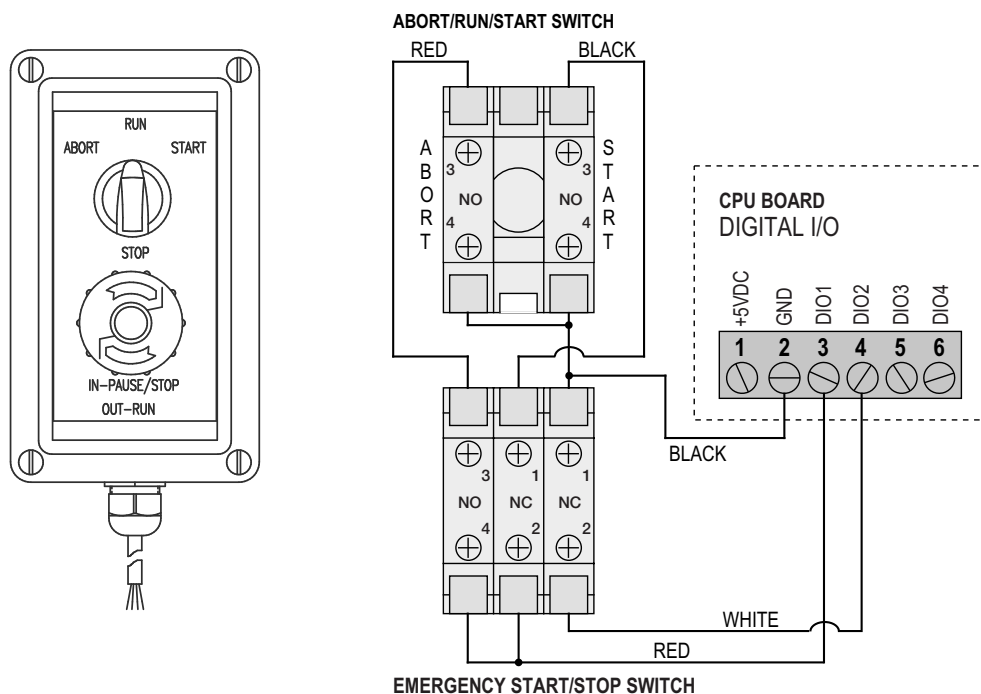

Figure 10-1. Batching Switch and Wiring Diagram Example

Exit configuration mode when configuration is complete. Initialize the batch by turning the 3-way switch to *ABORT*, then unlock the STOP button (the STOP button must be in the OUT position to allow the batch process to run). The batching switch is now ready to use.



WARNING: *Batching proceeds as if BATRUN were always on, if no digital input is assigned to BATRUN: the batch starts when the 3-way switch is turned to RUN, but the STOP mushroom button will not function.*

To begin a batch process, turn the 3-way switch to *START* momentarily. The process halts and the button locks in the IN position if the STOP button is pushed during the batch process.

The *START* switch is ignored while the STOP button is locked in the IN position. The STOP button must be turned counterclockwise to unlock it, then released to the OUT position to enable the 3-way switch.

To restart an interrupted batch from the step where it left off:

1. Unlock STOP button (OUT position).
2. Turn 3-way switch to *START*.

To restart an interrupted batch from the first batch step:

1. Turn 3-way switch to *ABORT*.
2. Unlock STOP button (OUT position).
3. Turn 3-way switch to *START*.



NOTE: *Use this procedure (or the BATRESET serial command) to initialize the new batch routine following any change to the setpoint configuration.*

10.3 Batching Example

The *Batching* parameter within the *Setpoints* menu must be set to *MANUAL*.



NOTE: *Digital I/O, Slot 0, Bit 1 = BATSTR
Digital I/O, Slot 0, Bit 2 = OUTPUT*

The following example is used to dispense material into a processing zone to a quantity of 1000 tons.

Setpoint 1 ensures that the belt is receiving material greater than 100 tn/h.

Kind = RATE
Value = 100
Trip = HIGHER
Batch Sequence = ON

Setpoint 2 ensures that the belt is not overloaded with material and receiving less than 200 tn/h.

Kind = RATE
Value = 200
Trip = LOWER
Batch Sequence = ON

Setpoint 3 tracks the total weight moving across the belt. Once Totalizer 1 equals 1000 tons, the feeder supplying material to the belt is stopped.

Kind = TOTAL
Value = 1000
Source = TOTALIZER 1
Trip = HIGHER
Batch Sequence = ON
Slot = SLOT0
Digital Output = BIT2

11.0 Maintenance

The maintenance information in this manual is designed to cover aspects of maintaining and troubleshooting the 882D. Contact Rice Lake Weighing Systems if a problem requires technical assistance.



NOTE: Have the scale model number and serial number available when calling for assistance.

11.1 Maintenance Checkpoints

The scale must be checked frequently to determine when a calibration is required. It is recommended a zero calibration be checked every other day and a calibration checked every week for several months after installation. Observe the results and lengthen the period between calibration checks, depending upon the accuracy desired.



NOTE: Establish a routine inspection procedure including the belt conveyor scale and the entire material handling system. Note any changes in the scale function and report them to the individual or department responsible for the scales' performance.

11.2 Field Wiring

If a problem with the belt scale wiring is suspected, check the electrical portion of the scale.

- Check for proper interconnections between the components of the system. All the wiring must be as specified on the installation drawings.
- Check all wiring and connections for continuity, shorts and grounds using an ohmmeter.
- Loose connections, poor solder joints, shorted or broken wires and unspecified grounds in wiring cause erratic readings and shifts in weight readings.
- Check all cable shields to ensure grounding is made at only the locations specified in the installation drawings.

11.3 Troubleshooting Tips

Table 11-1 lists general troubleshooting tips for hardware and software error conditions

Symptom	Possible Cause	Remedy
882D does not power up	Bad power supply	Check fuses and replace if necessary; If fuses are good, check all voltages on CPU board; Power supply should output both +6 V and -6 V levels to the CPU board
Battery backed corrupt error message at startup	Dead battery	Perform configuration reset then check for low battery warning on display; If battery is low, replace battery, perform another configuration reset, then reload files/configuration
Divide by zero error message at startup	User program error	Rework the iRite user program to eliminate divide-by-zero situations
Dashes in weight display	Over or under range scale condition	Check scale; For out-of-range conditions in total scale display, check all scale inputs for positive weight values
Display reads 0.000000	Scale not updating	Make sure that all cables/wires are connected for the pulse input and/or load cell; A power cycle might be necessary
Cannot enter setup mode	Bad switch	Test switch
Serial port not responding	Configuration error	Ensure port INPUT parameter is set to CMD for command input
A/D scale out of range	Scale operation Load cell connection Bad load cell	Check source scale for proper mechanical operation Check load cell and cable connection Check 882D operation with load cell simulator
Option card failure	Possible defective card or slot	Disconnect power, install card in different slot, then apply power again

Table 11-1. Basic Troubleshooting

11.4 Battery Replacement

The 882D display shows **low bat** when battery voltage depletes to 2.9 VDC. Replace the battery when this warning is displayed to prevent data loss in the event of a power failure. The battery life varies depending on use. It is recommended to replace the battery every three years, or sooner, if left powered off for extended periods of time.

Use the Revolution configuration utility ([Section 6.0 on page 55](#)) or EDP commands ([Section 7.0 on page 57](#)) to store a copy of the 882D configuration on a PC before attempting battery replacement. The 882D configuration can be restored from the PC if data is lost.



WARNING: Risk of explosion if battery is replaced with an incorrect type. Dispose of used batteries according to state and local regulations.

11.5 Board Replacement

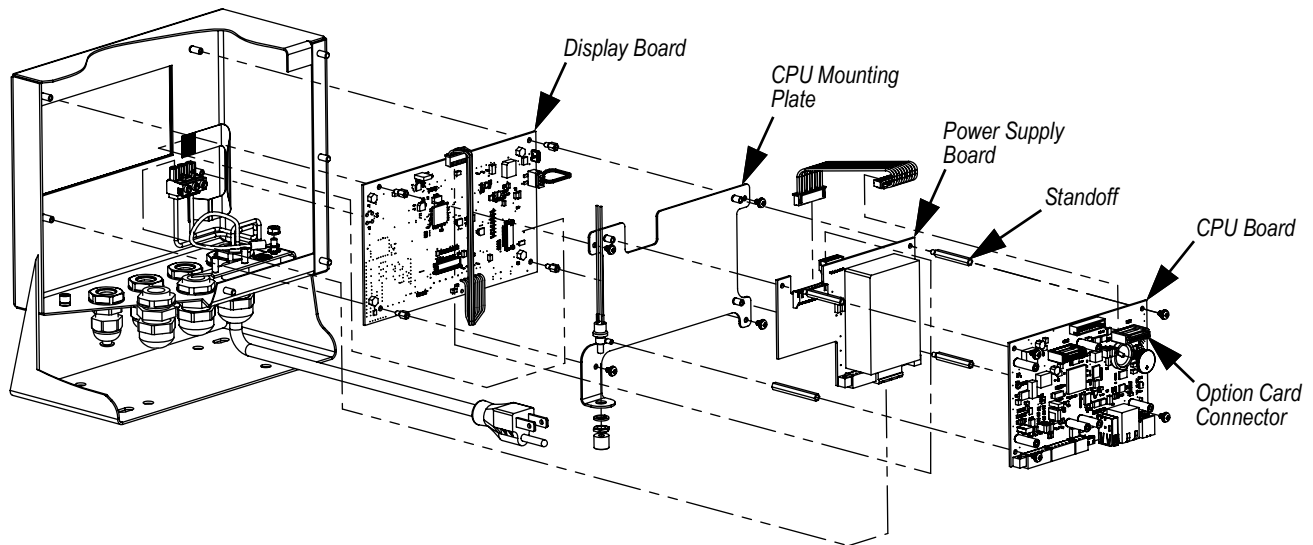

Figure 11-1. Board Locations

1. Disconnect power to the 882D.
2. Remove the backplate from the enclosure. See [Section 2.3 on page 12](#).



NOTE: Label connections for re-installation of board.

3. Remove installed option card(s) (if applicable).
 - Disconnect all cables from the option card.
 - Remove the three screws that attach the option card to the CPU board.
 - Lift the option card out of the enclosure.
4. Disconnect all cables from the CPU board.
5. Remove the four screws that secure the CPU board to the CPU mounting plate.
6. Lift the CPU board out of the enclosure.



NOTE: If only replacing CPU board, place the new CPU board in place, secure with screws torqued to 4 in-lb (0.45 N-m) and reconnect all cables.

If replacing other boards, continue with [Step 7](#).

7. Disconnect all cables from the power supply board.
8. Remove the three standoffs that secure the power supply board to the CPU mounting plate.
9. Lift the power supply board out of the enclosure.



NOTE: If only replacing power supply board, place the new board in place, secure with standoffs torqued to 4 in-lb (0.45 N-m), reconnect all cables and reverse the above procedure to complete.

If replacing the display board, continue with [Step 10](#).

10. Remove the four screws securing the CPU mounting plate to the display board.
11. Lift the CPU mounting plate out of the enclosure.
12. Disconnect all cables from the display board.
13. Remove the four standoffs that secure the display board to the enclosure.
14. Lift the display out of the enclosure.
15. To install the new display board, reverse the above procedure. Torque screws and standoffs to 4 in-lb (0.45 N-m).

11.6 CPU Board Excitation Fuses

11.6.1 Fuse Check

Follow these steps to measure the excitation voltage using a volt meter.

1. Touch the ground lead to the metal housing of the Ethernet connector.
2. Touch the positive lead to:
 - Pin 5 of the J1 connector for the +excitation reading
 - Pin 6 of the J1 connector for the -excitation reading
3. A reading near 5V (+ or - depending on the pin) means the fuse is good and a reading of zero means the fuse is bad.

11.6.2 Fuse Replacement

There are two 0.315A fuses (PN 186173) on the backside of the CPU board for circuit protection. Refer to [Section 11.5 on page 88](#) to remove the CPU board. F202 is for +5V and F203 is for -5V ([Figure 11-2](#)).

1. Place the CPU board top-down on an anti-static work mat.
2. Use a small flathead screwdriver or a needle-nose pliers to remove fuse.
3. Push the new fuse into place.

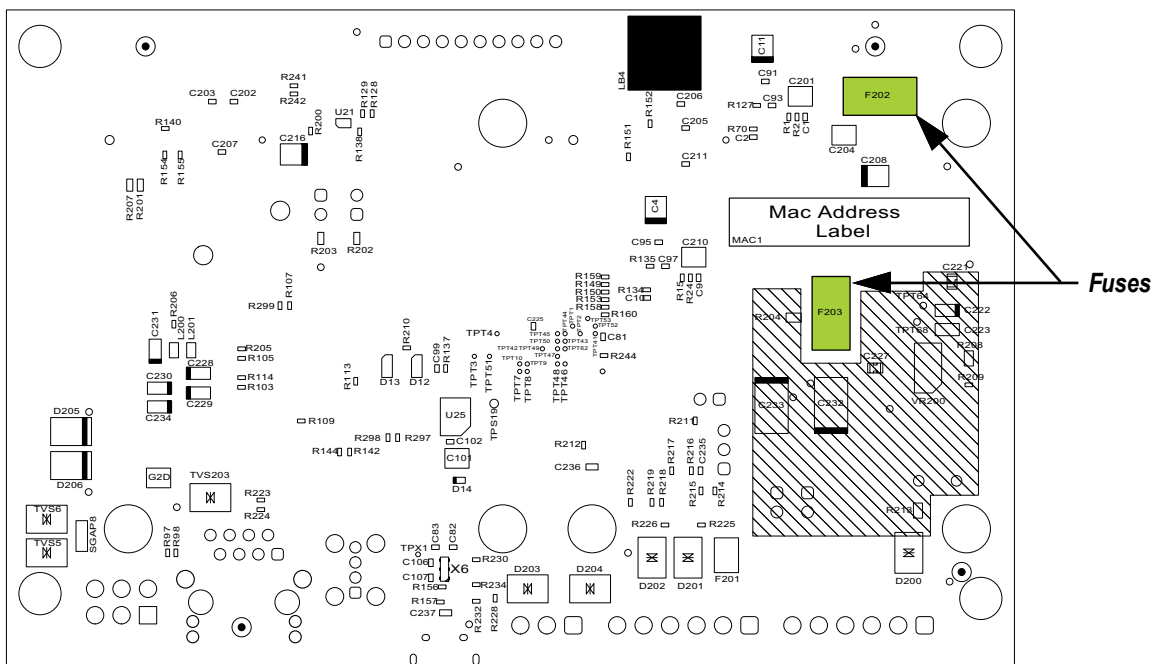

Figure 11-2. Backside of CPU Board

11.7 882D Permanent Field Record

Keep this as a record of maintenance performed on the belt scale system.

Conveyor Number	_____
Date	_____
Scale Capacity (Tons per Hour)	_____
Load Cell mV/V (Average)	_____
Number of Load Cells (NLC)	_____
Load Cell Capacity (LCC)	_____
Total Load Cell Build = NLC x LCC	_____
Number of Weigh Idlers	_____
Idler Spacing	_____
Conveyor Belt Length	_____
Pulses per Revolution	_____
Number of Test Revolutions	_____
Zero Counts	_____
Correction Factor	_____

12.0 Appendix

12.1 Error Messages

The 882D provides a number of error messages. When an error occurs, the message is shown on the display. Error conditions can also be checked remotely by using the XE EDP command as described in [Section 7.2.6 on page 61](#).

12.1.1 Displayed Error Messages

The 882D provides a number of front panel error messages to assist in problem diagnosis.

Error Message	Description	Solution
— — — — —	Over range (upper dashes)	Check for improper load cell wiring, configuration, calibration, scale hardware problems
__ __ __ __	Under range (lower dashes)	
— — — — —	A/D out of range (centered dashes) Or if using local/remote (serial scale) - loss of serial scale data.	
OVERFLOW	Weigh string too large to be displayed	Increase the count by to decrease the size of the weigh string
CFGERR	Configuration error on power up if there was an error loading configuration	Press the Enter key to reboot the 882D
ERROR	Internal program error	Check configuration
HWFERR	Hardware failure error on failure to write to the EEPROM any error (except for a battery error or an accumulation over range error) when exiting the menu	Press the Enter key to reboot the 882D
LOBATT	The low battery error flashes every 30 seconds when the battery is low.	Replace the battery
RANGE	A numeric value entered in configuration is out of the acceptable range. The error is displayed momentarily – then parameter being edited is displayed so the value can be corrected.	Re-enter a value that is in range for the parameter being edited
NO ZERO	Zero is prevented (due to regulatory mode settings, motion on the scale, zero range settings)	Check zero settings and for motion
SPEED INPUT n ERROR	Pulse input error; n = 1 or 2; This error is displayed when there is not pulse input detected by the pulse input circuit.	Check that the belt is in motion and that the speed sensor and wiring are working correctly

Table 12-1. 882D Error Messages

12.2 Using the HARDWARE Command

The HARDWARE serial command can be used to verify that installed option cards are recognized by the system. The HARDWARE command returns three 3-digit card codes, representing the cards installed. HARDWARE=000,yyy,zzz is the returned format, where yyy is for slot 1 and zzz is for slot 2.

Code	Card Type
000	No card installed
032	24-Channel Digital I/O Card
033	24Volt 8-Channel DIO Card
085	Relay Card
153	Analog Output Card
170	Fieldbus Card

Table 12-2. HARDWARE Command Option Card Type Codes

The HARDWARE command returns code of 000 if an installed card is not recognized. Ensure card is seated properly. Reinstall the card, if necessary, then cycle the power to read the configuration again. Try a different option card if the card is still not recognized.

12.3 ASCII Character Chart

Use the decimal values for ASCII characters when specifying print format strings on the PFORMT menu. The actual character printed depends on the character mapping used by the output device.

The indicator can send or receive any ASCII character value (decimal 0–255), but due to limitations of the indicator display, some characters cannot be shown.

Control	ASCII	Dec	Hex	ASCII	Dec	Hex	ASCII	Dec	Hex	ASCII	Dec	Hex
Ctrl-@	NUL	00	00	space	32	20	@	64	40	`	96	60
Ctrl-A	SOH	01	01	!	33	21	A	65	41	a	97	61
Ctrl-B	STX	02	02	"	34	22	B	66	42	b	98	62
Ctrl-C	ETX	03	03	#	35	23	C	67	43	c	99	63
Ctrl-D	EOT	04	04	\$	36	24	D	68	44	d	100	64
Ctrl-E	ENQ	05	05	%	37	25	E	69	45	e	101	65
Ctrl-F	ACK	06	06	&	38	26	F	70	46	f	102	66
Ctrl-G	BEL	07	07	'	39	27	G	71	47	g	103	67
Ctrl-H	BS	08	08	(40	28	H	72	48	h	104	68
Ctrl-I	HT	09	09)	41	29	I	73	49	i	105	69
Ctrl-J	LF	10	0A	*	42	2A	J	74	4A	j	106	6A
Ctrl-K	VT	11	0B	+	43	2B	K	75	4B	k	107	6B
Ctrl-L	FF	12	0C	,	44	2C	L	76	4C	l	108	6C
Ctrl-M	CR	13	0D	-	45	2D	M	77	4D	m	109	6D
Ctrl-N	SO	14	0E	.	46	2E	N	78	4E	n	110	6E
Ctrl-O	SI	15	0F	/	47	2F	O	79	4F	o	111	6F
Ctrl-P	DLE	16	10	0	48	30	P	80	50	p	112	70
Ctrl-Q	DC1	17	11	1	49	31	Q	81	51	q	113	71
Ctrl-R	DC2	18	12	2	50	32	R	82	52	r	114	72
Ctrl-S	DC3	19	13	3	51	33	S	83	53	s	115	73
Ctrl-T	DC4	20	14	4	52	34	T	84	54	t	116	74
Ctrl-U	NAK	21	15	5	53	35	U	85	55	u	117	75
Ctrl-V	SYN	22	16	6	54	36	V	86	56	v	118	76
Ctrl-W	ETB	23	17	7	55	37	W	87	57	w	119	77
Ctrl-X	CAN	24	18	8	56	38	X	88	58	x	120	78
Ctrl-Y	EM	25	19	9	57	39	Y	89	59	y	121	79
Ctrl-Z	SUB	26	1A	:	58	3A	Z	90	5A	z	122	7A
Ctrl-[ESC	27	1B	;	59	3B	[91	5B	{	123	7B
Ctrl-\	FS	28	1C	<	60	3C	\	92	5C		124	7C
Ctrl-]	GS	29	1D	=	61	3D]	93	5D	}	125	7D
Ctrl-^	RS	30	1E	>	62	3E	^	94	5E	~	126	7E
Ctrl-_	US	31	1F	?	63	3F	_	95	5F	DEL	127	7F

Table 12-3. ASCII Character Chart (Part 1)

ASCII	Dec	Hex	ASCII	Dec	Hex	ASCII	Dec	Hex	ASCII	Dec	Hex
Ç	128	80	á	160	A0		192	C0	α	224	E0
ü	129	81	í	161	A1		193	C1	β	225	E1
é	130	82	ó	162	A2		194	C2	Γ	226	E2
â	131	83	ú	163	A3		195	C3	π	227	E3
ä	132	84	ñ	164	A4		196	C4	Σ	228	E4
à	133	85	Ñ	165	A5		197	C5	σ	229	E5
â	134	86	ª	166	A6		198	C6	μ	230	E6
ç	135	87	º	167	A7		199	C7	τ	231	E7
ê	136	88	¿	168	A8		200	C8	Φ	232	E8
ë	137	89		169	A9		201	C9	Θ	233	E9
è	138	8A	¬	170	AA		202	CA	Ω	234	EA
ï	139	8B	½	171	AB		203	CB	δ	235	EB
î	140	8C	¼	172	AC		204	CC	∞	236	EC
ì	141	8D	¡	173	AD		205	CD	φ	237	ED
Ä	142	8E	«	174	AE		206	CE	€	238	EE
Å	143	8F	»	175	AF		207	CF	∩	239	EF
É	144	90		176	B0		208	D0	≡	240	F0
æ	145	91		177	B1		209	D1	±	241	F1
Æ	146	92		178	B2		210	D2	≥	242	F2
ô	147	93		179	B3		211	D3	≤	243	F3
ö	148	94		180	B4		212	D4	∫	244	F4
ò	149	95		181	B5		213	D5	∫	245	F5
û	150	96		182	B6		214	D6	÷	246	F6
ù	151	97		183	B7		215	D7	≈	247	F7
ÿ	152	98		184	B8		216	D8	°	248	F8
Ö	153	99		185	B9		217	D9	•	249	F9
Ü	154	9A		186	BA		218	DA		250	FA
ϕ	155	9B		187	BB		219	DB		251	FB
£	156	9C		188	BC		220	DC		252	FC
¥	157	9D		189	BD		221	DD	²	253	FD
Pts	158	9E		190	BE		222	DE		254	FE
f	159	9F		191	BF		223	DF		255	FF

Table 12-4. ASCII Character Chart (Part 2)

12.4 Data Formats

12.4.1 Stream Serial Data Format

If stream data transmission is configured for the communication ports (*STRLFT* or *STRIND*), by default the 882D sends data using the serial data format shown in Figure 12-1. RS-422 is also available and uses the same serial data format.

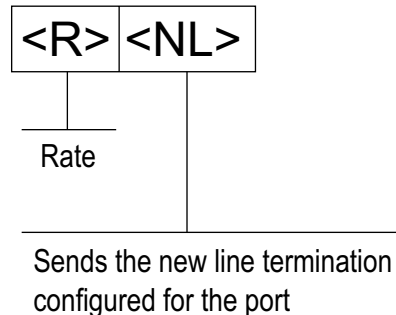

Figure 12-1. Stream Serial Data Format



NOTE: If the COM port is set to TYPE = RS485, the port will not stream data.

12.4.2 Stream Tokens

Token	Description
<R>	The current rate with units included
<S>	The current speed with units included
<L>	The current load with units included
<MT>	Master Totalizer value – without units
<T1>	Totalizer 1 value – without units
<T2>	Totalizer 2 value – without units
<TU>	Totalizer units (kg, lb, t or tn); Defined by Totalizer Resolution Parameter
<DT1>	Date of the last Totalizer 1 clear
<TT1>	Time of the last Totalizer 1 clear
<DT2>	Date of the last Totalizer 2 clear
<TT2>	Time of the last Totalizer 2 clear
<CR>	Carriage return, hex 0x0D
<LF>	Line feed, hex 0x0A
<FF>	Form feed, hex 0x0C
<USnn>	Insert user print text string (from iRite user program, SetPrintText API); Defined by iRite user program
<SPnn>	Space, nn = number of spaces; If nn is not specified, 1 is assumed; Value must be in the range 1-99
<NLnn>	New line, nn = number of termination (<CR/LF> or <CR>) characters; If nn is not specified, 1 is assumed; Value must be in the range 1-99; Defined by TERMIN setting of the port Note: when streaming data, a configured End-of-Line Delay is performed after each New Line
<nnn>	ASCII character (nnn = decimal value of ASCII character). Used for inserting control characters (002 for an STX, for example) in the output.

Table 12-5. Stream Tokens

12.4.3 Print Output Serial Data Format

The 882D uses a data string format for a basic ticket printout. The print format is configured in the setup menu for the demand (print) port, and depends on the 882D configuration and mode. See [Section 8.0 on page 77](#) for print formatting.

Use the EDP commands, Revolution or the front panel to fully customize the print to work with a wide variety of printers, and other remote equipment.

12.4.4 RS-485 Data Formats

The 882D has a built-in RS-485 software protocol which is enabled when configuring a port's TYPE as 485. On the 882D only the COM port has hardware support for RS-485 communication.

All RS-485 communication with the 882D is via command and response. An external host must send a command and wait for a response.

All remote commands are initiated using the data format in [Figure 12-2](#):

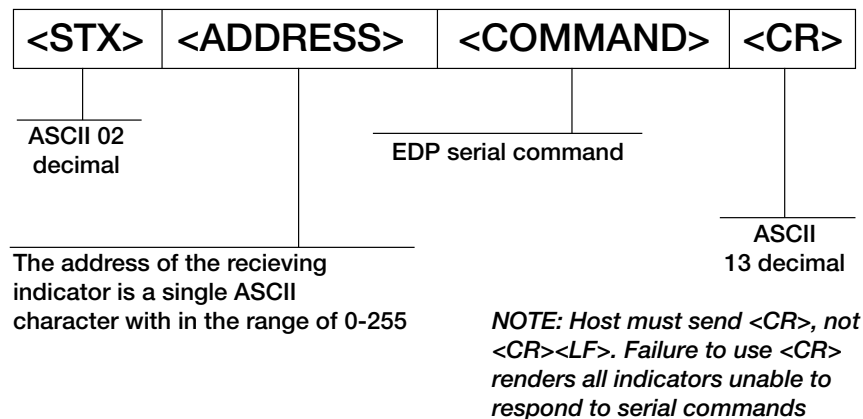

Figure 12-2. RS-485 Send Data Format

If the initiating device address matches the port address of a 882D on the RS-485 network, that indicator responds. The responding indicator uses the format in [Figure 12-3](#):

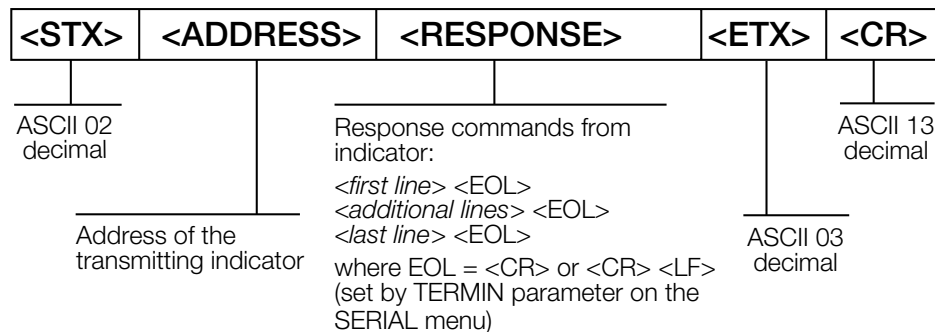

Figure 12-3. RS-485 Respond Data Format

- * Communication with an RS-485 882D is command / response only; An 882D configured for RS-485 cannot print a ticket or stream continuous data
- * Any valid EDP command can be sent to the 882D when in RS-485 mode
- * If a command is unrecognized or cannot be executed, the 882D responds with ?? wrapped in the RS-485 protocol
For example: <STX><ADDRESS>??<ETX><CR>
- * Depending on the command, the <RESPONSE> may include its own termination characters that are sent before the <ETX><CR>
- * A multi-line response, e.g. from a DUMPALL command, is wrapped in the header and footer as a total but each individual line is not

<STX><ADDRESS><first line> <EOL>
<additional lines> <EOL>
<last line> <EOL><ETX><CR>

Where:

EOL - <CR> or <CR><LF> (set by the *TERMIN* parameter for the port)

Example: To send the LD command from an ASCII terminal to an indicator at address 65 (decimal) on the RS-485 network, use the format in [Figure 12-2 on page 95](#).

- The keyboard equivalent for the start-of-text (STX) character is CONTROL-B ([Section 12.3 on page 92](#))
- The indicator address (65) is represented by an upper case "A"
- The carriage return (CR) character is generated by pressing the **Enter** key

Therefore, to send the LD command to the indicator at address 65, enter the following at the terminal:
<CONTROL-B>A65<CR>

The indicator responds with <STX>A 1234.00 lb/ft<CR><LF><ETX><CR>. See [Section 7.0 on page 57](#) for other commands that can be used.







12.5 Analog Output Calibration







See [Section 4.6.7 on page 43](#), for Analog Output parameters.

The following calibration procedure requires a multimeter to measure voltage or current output from the analog output module. If the option is not already installed, install it in according to the instructions included with the option.



NOTE: The analog output must be calibrated after the 882D has been configured ([Section 4.0 on page 27](#)) and calibrated ([Section 5.0 on page 46](#)).

1. Enter configuration mode and go to the Analog Output menu ([Figure 4-20 on page 43](#)):
 - Set *Source* as desired to SCALE or PROG
 - Set *Mode* as desired to RATE, SPEED or LOAD
 - Set *Output* as desired for 0-10V, 0-20mA, or 4-20mA output
 - Set *Minimum* to lowest value to be tracked by the analog output
 - Set *Maximum* to highest value to be tracked by the analog output
2. Connect multimeter to connector J1 on the analog output board:
 - For voltage output, connect voltmeter leads to pins 3 and 4 (-V, +V)
 - For current output, connect ammeter leads to pins 1 and 2 (-mA, +mA)
3. Adjust zero calibration:
 - Scroll to the *Calibrate Zero* parameter
 - Press , 0.000000 will display
 - Check voltage or current reading on multimeter
 - Set the parameter to match the reading from the multimeter
 - Press  or  to select the digit
 - Press  or  to increment or decrement the value
 - Press  to accept the displayed value
 - CAL will be displayed while the calibration is being performed

4. Adjust span calibration:
 - Scroll to the *Calibrate Span* parameter
 - Press , 0.000000 will display
 - Set the parameter to match the reading from the multimeter
 - Press  or  to select the digit
 - Press  or  to increment or decrement the value
 - Press  to accept the displayed value
 - CAL will be displayed while the calibration is being performed
5. Verify calibration:
 - Return to the Calibrate Zero/Calibrate Span parameter and verify that the calibration has not drifted
 - Repeat calibration if needed
6. Return to weigh mode.

12.6 Cable Specifications

Connector	Wire Gauge Range	Wire Strip Length
J1 and J2 (PN 153873)	16-28 AWG	0.276 in (7 mm)
J3 (PN 153883)	16-28 AWG	0.276 in (7 mm)
J13 (PN 181694)	16-24 AWG	0.394 in (10 mm)
DC Power (PN 15888)	12-24 AWG	0.276 in (7 mm)

Table 12-6. Recommended Wire Gauge Specifications

Cord Grip	Diameter Range
PG9 (PN 15626)	0.138 - 0.315 in (3.5 - 8 mm)
PG11 (PN 68600)	0.197 - 0.394 in (5 - 10 mm)

Table 12-7. Cord Grip Specifications

12.7 CPU Board Components

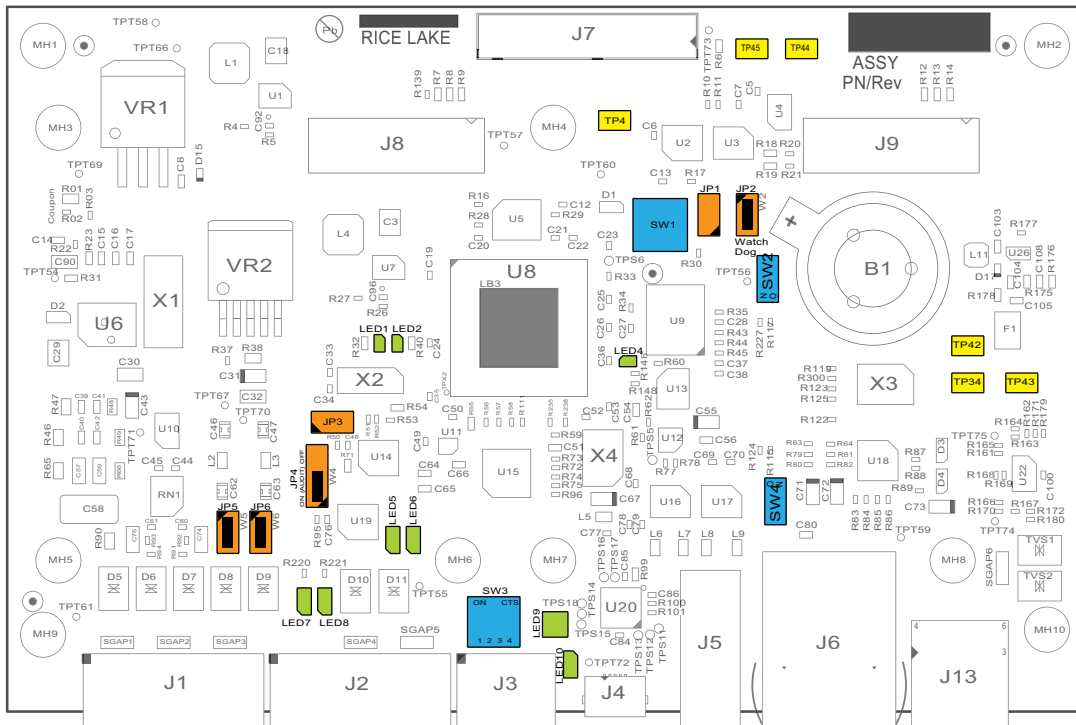



Figure 12-4. CPU Board

Component	Description
JP1	Not used
JP2	Watchdog jumper – Leave jumper shorted for normal operation
JP3	Remote setup switch header
JP4	Audit jumper
JP5	Remote sense jumper
JP6	Remote sense jumper
LED1	Not used
LED2	Not used
LED4	882D heartbeat
LED5	Digital I/O 3
LED6	Digital I/O 4
LED7	Digital I/O 1
LED8	Digital I/O 2
LED9	Transmit and receive for the serial port (2 LEDs)
LED10	Not used
SW1	Hardware reset switch
SW2	Not used
SW3	RS-232 / RS-485 / RS-422 switches (Section 2.4.7 on page 16)
SW4	Not used
TP4	Battery ground test point
TP34	Pulse input 0 test point
TP42	Pulse input 1 test point
TP43	Pulse input ground test point
TP44	Battery voltage + test point
TP45	Battery voltage - test point

Table 12-8. CPU Board Components

13.0 Compliance

	EU DECLARATION OF CONFORMITY <i>EU-KONFORMITÄTSERKLÄRUNG</i> <i>DÉCLARATION UE DE CONFORMITÉ</i>		Rice Lake Weighing Systems 230 West Coleman Street Rice Lake, Wisconsin 54868 United States of America 
	Type/Typ/Type: 882D		
English	We declare under our sole responsibility that the products to which this declaration refers to, is in conformity with the following standard(s) or other regulations document(s).		
Deutsch	Wir erklären unter unserer alleinigen Verantwortung, dass die Produkte auf die sich diese Erklärung bezieht, den folgenden Normen und Regulierungsbestimmungen entsprechen.		
Français	Nous déclarons sous notre responsabilité que les produits auxquels se rapporte la présente déclaration, sont conformes à la/aux norme/s suivante ou au/aux document/s normatif/s suivant/s.		
EU Directive	Certificates	Standards Used / Notified Body Involvement	
2014/30/EU EMC	-	EN 61326-1:2013, EN 55011:2009+A1:2010	
2014/35/EU LVD	-	EN 60950-1:2006+A11:2009/A1:2010/A12:2011/A2:2013, EN 62368-1:2014	
2011/65/EU RoHS	-	EN 50581:2012	
2014/34/EU ATEX	DEMKO 20 ATEX 2164X	EN 60079-0:2012+A11:2013, EN 60079-11:2012, EN 60079-7: 2015 +A1:2018, EN 60079-15: 2010, EN 60079-31:2014 Notified Body involved with module B: / Benannte Stelle, die an Modul B beteiligt ist: / Organisme notifié impliqué dans les modules B: UL International Demko A/S - 0539	
Signature:	<u>Brandi Harder</u>		Place: <u>Rice Lake, WI USA</u>
Name:	<u>Brandi Harder</u>		Date: <u>April 16, 2021</u>
Title:	<u>Quality Manager</u>		

Form 1126 Rev.1 03/19

Approved by: Quality Department



UK DECLARATION OF CONFORMITY

Rice Lake Weighing Systems
 230 West Coleman Street
 Rice Lake, Wisconsin 54868
 United States of America



Type: 882D Indicator

English We declare under our sole responsibility that the products to which this declaration refers to, is in conformity with the following standard(s) or other regulations document(s).

UK Regulations	Certificates	Standards Used / Approved Body Involvement
2016/1101 Low Voltage	-	882D: EN 62368-1:2014 + A11:2017
2016/1091 EMC	-	EN 61326-1:2013, EN 61000-3-3:2013, EN 61000-6-2, EN 61000-6-4, EN55011:2009/A1:2010
2012/3032 RoHS	-	EN 50581:2012

Signature: Brandi Harder

Place: Rice Lake, WI USA

Name: Brandi Harder

Date: December 20, 2022

Title: Quality manager

14.0 Specifications

Power:

Input voltages: 100 to 240 VAC; 9 to 36 VDC
Input frequency: 50/60 Hz

Power Consumption:

AC: 15 watts; DC: 20 watts

Excitation Voltage:

10 VDC 8 × 350 ohm (16 × 700 ohm) load cells

Analog Signal Input Range:

-45 mV to 45 mV

Analog Signal Sensitivity:

0.3 μ V/graduation minimum at 7.5 Hz;
1.0 μ V/graduation typical at 120 Hz

Sample Rate:

7.5 to 120 Hz, software selectable

Resolution:

Internal: 8,000,000 counts 23-bit
Display: 100,000

System Linearity:

\pm 0.01% full scale

Digital I/O:

Four I/O onboard primary keys, pseudo functions,
batching functions

Communication Ports:

RS-232 full duplex or RS-485 half duplex; USB 2.0
Micro B connector; Ethernet TCP/IP

Pulse Input:

Dual inputs for redundancy

Display:

LCD display, 0.8 in, seven-digit, seven-segment
weight display, 3 × 20 pixelated prompt area

Annunciators:

Load, total, rate, speed, zero

Keys/Buttons:

Flat membrane panel, tactile feel

Operating Temperature:

Industrial: 14 °F to 122 °F (-10 °C to 50 °C)

Dimensions:

(L x W x H)
9.93 × 4.00 × 8.94 in

Weight:

12 lb (5.4 kg)

Rating/Material:

IP66
Stainless steel

Warranty:

Two-year limited

EMC Immunity:

18 KV, 10 V/m

Certifications and Approvals



UL
Universal model
File Number: E151461





© Rice Lake Weighing Systems Content subject to change without notice.

230 W. Coleman St. • Rice Lake, WI 54868 • USA USA: 800-472-6703 • International: +1-715-234-9171