

882IS and 882IS Plus

Intrinsically Safe Indicator/Controller

Version 1.1

Technical Manual



© Rice Lake Weighing Systems. All rights reserved.

Rice Lake Weighing Systems® is a registered trademark of
Rice Lake Weighing Systems.

All other brand or product names within this publication are trademarks or
registered trademarks of their respective companies.

All information contained within this publication is, to the best of our knowledge, complete and
accurate at the time of publication. Rice Lake Weighing Systems reserves the right to make
changes to the technology, features, specifications and design of the equipment without notice.

The most current version of this publication, software, firmware and all other product
updates can be found on our website:

www.ricelake.com

Revision History

This section tracks and describes the manual revisions for awareness of major updates.

Revision	Date	Description
–	June 7, 2019	Initial manual release with the launch of the product; firmware version 1.0
I	February 17, 2022	Revision history established after Rev I
J	December 22, 2022	Updates made to clarify power saving modes and the 30-second sleep timer; cord grip specifications and UKCA declaration of conformity added
K	September 9, 2024	Added configurable sleep timer; Firmware version 1.10; added time and date details
L	January 29, 2024	Added battery charging updates

Table i. Revision Letter History



Technical training seminars are available through Rice Lake Weighing Systems. Course descriptions and dates can be viewed at www.ricelake.com/training or obtained by calling 715-234-9171 and asking for the training department.

Contents

1.0	Introduction	9
1.1	Options	9
1.2	Safety	10
1.3	FCC Compliance	10
1.4	Disposal	11
1.5	FM Approval	11
1.6	Hazardous Location Labels	12
1.7	Operating Modes	12
1.8	Front Panel Display	13
1.9	General Navigation	14
1.9.1	Edit Parameter Values	15
1.9.2	Alphanumeric Entry Procedure	15
1.10	Indicator Operations	15
1.10.1	Toggle Gross/Net Mode	15
1.10.2	Toggle Units	15
1.10.3	Zero Scale	15
1.10.4	Acquire Tare	15
1.10.5	Remove Tare Value	16
1.10.6	Preset Tare (Keyed Tare)	16
1.10.7	Print Ticket	16
1.10.8	Front Panel User Setup	16
1.10.9	Displaying Audit Trail Information	16
1.10.10	Display Accumulator	17
1.10.11	Clear the Accumulator	17
1.10.12	Display Tare	17
2.0	Installation	18
2.1	Unpacking and Assembly	18
2.2	Product Dimensions	18
2.3	Hazardous Area Installation	19
2.4	Mounting Instructions	20
2.4.1	Backplate Removal	20
2.5	Cable Connections on the 882IS	21
2.5.1	Cord Grip Specifications	21
2.5.2	Power Supply to Indicator	21
2.5.3	AC Power Wiring	21
2.5.4	Battery Option	22
2.5.5	Load Cells	22
2.5.6	Cable Shield Grounding	23
2.5.7	CPU Board Replacement	23
2.5.8	Serial Communications - Port 1 (COM)	24
2.6	CPU Board	25
2.7	Audit Trail	26
2.8	Digital Inputs	26
2.9	Backplate Attachment	26
2.10	Legal for Trade Sealing	27
2.11	IO Module Option Cards	27
2.12	Rechargeable Battery Usage	27
2.13	Replacement Parts	28



Rice Lake continually offers web-based video training on a growing selection of product-related topics at no cost. Visit www.ricelake.com/webinars

3.0 Configuration	29
3.1 Configuration Methods	29
3.2 User Setup Menu	30
3.2.1 Audit Menu	30
3.2.2 User ID	30
3.2.3 Setup Menu	31
3.2.4 Scale Menu	31
3.2.5 Scale Format Menu - if Split = Off	33
3.2.6 Scale Format Menu - if split = 2 RNG, 3 RNG, 2 INTVL, 3 INTVL	34
3.2.7 Calibration Menu	35
3.2.8 Features Menu	36
3.2.9 Region Menu	37
3.2.10 Region - Regulation - Indust	38
3.2.11 Keylock Menu	39
3.2.12 Setup Ports Menu	39
3.2.13 Ports - Serial Ports Menu	40
3.2.14 Ports - Fiber Optics Menu	41
3.2.15 Print Format Menu	42
3.2.16 Digital Inputs Menu	43
3.2.17 IO Module Menu	44
3.2.18 Power Savings Menu	49
3.2.19 Version Menu	50
3.3 Test Menu	50
3.4 Time and Date	50
3.5 Accumulator Menu	51
3.6 Tare	51
4.0 Calibration	52
4.1 Front Panel Calibration	53
4.1.1 Five-Point Linearization	54
4.1.2 Rezero	54
4.2 Last Zero	55
4.3 Temporary Zero	55
4.4 Adjusting Final Calibration (Trimming)	55
4.5 Gravity Compensation	55
4.6 EDP Command Calibration	55
4.7 Revolution® Calibration	56
5.0 Using Revolution	57
5.1 Communication With the Indicator	57
5.2 Configuration	58
5.2.1 New Configuration File	58
5.2.2 Open an Existing Configuration File	58
5.2.3 Saving a Configuration File	58
5.3 Revolution Help	58
6.0 EDP Commands	59
6.1 The EDP Command Set	59
6.1.1 Key Press Commands	59
6.1.2 Reporting Commands	60
6.1.3 The RESETCONFIGURATION Command	60



Technical training seminars are available through Rice Lake Weighing Systems. Course descriptions and dates can be viewed at www.ricelake.com/training or obtained by calling 715-234-9171 and asking for the training department.

6.1.4	Parameter Setting Commands	60
6.1.5	Scales Menu	61
6.1.6	Format Menu	61
6.1.7	Calibration Menu	62
6.1.8	Fiber COM Menu	63
6.1.9	Stream Tokens Menu	63
6.1.10	Feature Menu	63
6.1.11	Regulatory Menu	64
6.1.12	Passwords Menu	64
6.1.13	Keypad Lock Menu	64
6.1.14	Print Format Menu	64
6.1.15	Digital I/O Configuration Menu	65
6.1.16	Weigh Mode Commands	65
6.1.17	Power Commands	66
6.1.18	Setup Mode Commands	66
6.1.19	Analog Output Parameters	66
6.1.20	Analog Output Commands	67
6.1.21	Test Commands	67
7.0	Print Formatting	68
7.1	Print Formatting Tokens	68
7.2	Default Print Formats	69
7.3	Customizing Print Formats	69
7.3.1	Using the EDP Commands	69
7.3.2	Using the Front Panel	70
7.3.3	Using Revolution	70
8.0	Setpoints	71
8.1	Hardware Requirements	72
8.2	Software Requirements	72
8.3	Connect the Fiber-Optic Cable	72
8.4	920i iRite Software Setup Procedure	73
8.5	920i Setup Procedure	74
8.6	882IS/882IS Plus Setup Procedure	74
8.7	Setpoint Configuration Procedure	74
8.8	Setpoint Batching	75
8.9	920i Batch Operations	75
9.0	IO Module	76
9.1	IO Module Disassembly	76
9.1.1	AC Wiring	76
9.1.2	RS-232/RS-422 Communications	76
9.2	USB Device Communications – Port 2	76
9.3	Ethernet Communications	77
9.4	Updating IO Module Firmware	77
10.0	Appendix	78
10.1	Error Messages	78
10.1.1	Displayed Error Messages	78
10.2	Using the HARDWARE Command	78
10.3	ERROR Commands Output	79



Rice Lake continually offers web-based video training on a growing selection of product-related topics at no cost. Visit www.ricelake.com/webinars

10.4	Status Messages	79
10.5	TARE and ZERO Key Functions	79
10.6	Data Formats	80
10.6.1	Stream Serial Data Format	80
10.6.2	Print Output Serial Data Format	80
10.7	Custom Stream Formatting – Input/Output	81
10.8	Stream Formatting Examples	83
10.8.1	Toledo 8142 Indicator	83
10.8.2	Cardinal 738 Indicator	84
10.8.3	Weightronix WI 120 Indicator	84
10.9	ASCII Character Chart	85
10.10	Digital Filtering	87
10.10.1	Sample Rate	87
10.10.2	Digital Filter	87
10.11	Updating the 882IS/882IS Plus CPU Firmware	87
10.12	Analog Output Calibration	88
11.0	Compliance	89
12.0	Specifications	91



Technical training seminars are available through Rice Lake Weighing Systems. Course descriptions and dates can be viewed at www.ricelake.com/training or obtained by calling 715-234-9171 and asking for the training department.



Rice Lake continually offers web-based video training on a growing selection of product-related topics at no cost. Visit www.ricelake.com/webinars

1.0 Introduction

This manual provides information on installation, configuration, calibration and servicing of the 882IS and 882IS Plus indicator. The installer should be familiar with requirements for installation of equipment in hazardous areas. Refer to the 882IS/882IS Plus Conditions of Use document (PN 191698) for the intrinsic safety certification and classification, specific conditions of use and system limitations and restrictions for the 882IS/882IS Plus.

Configuration and calibration of the indicator can be accomplished using the indicator front panel keys, the EDP command set or Revolution® configuration utility. See [Section 3.0 on page 29](#) for information about configuration methods.



Manuals are available from Rice Lake Weighing Systems at www.ricelake.com/manuals

Warranty information is available at www.ricelake.com/warranties

1.1 Options

Options and accessories are listed below.

Part No.	Description
180831	Battery option, IS6V2
194191	Battery charger, IS6V2, 100-240 VAC NEMA 5-15 (NA plug)
194189	Battery charger, IS6V2, 100-240 VAC (EU plug)
194192	Battery charger, IS6V2, 100-240 VAC (UK plug)
197591	Battery charger, IS6V2, 100-240 VAC (Australian Plug)
180837	Power supply, 882IS mb-EPS-100-240-X2, dual output 6.8 VDC 200 mA
195109	Power supply, 882IS mb-EPS-100-240-X2, dual output 6.8 VDC 200 mA, 1/2" NPT-M20
179668	Cable, M12 power 22' hazardous location (for battery version)
179669	Cable, M12 power 10' hazardous location
179670	Cable, M12 power 50' hazardous location
179671	Cable, M12 power 100' hazardous location
190979	Lockout device for M12 device
163751	Tilt stand, 882IS
179678	Tilt stand, 882IS battery option
177850	Panel mount option, gasketed non-NEMA seal

Table 1-1. Options and Accessories

Part No.	Description
177709	Module, 882 Smart I/O interface
196166	Module, 882 Smart I/O (EU power cord)
196165	Module, 882 Smart I/O (UK power cord)
196769	Option, Fiber/RS232 6x6 FRP Enclosure, Fiber Optic-232 converter, External Power Supply
196770	Option, Fiber/RS422 6x6 FRP Enclosure, Fiber-RS422 converter, External Power Supply
78026	Cable, Plastic Optical 100' includes polishing kit
78027	Cable, Plastic Optical 200' includes polishing kit
197384	Kit, polishing POF cable
Option Cards	
190528	Single analog output (0-10VDC, 0-20mA, 4-20mA)
190530	882 option, EtherNet/IP
190531	882 option, DeviceNet
190532	882 option, ProfiNet
190534	882 option, Profibus
190533	882 option, Modbus TCP
Remote Indicator for Setpoint Functionality	
203343	920i universal indicator, 115 VAC, no A/D, with 882IS iRite software for setpoints
203344	920i wall mount indicator, 115 VAC, no A/D, with 882IS iRite software for setpoints

Table 1-2. Optional I/O Module

1.2 Safety

Safety Definitions:



DANGER: Indicates an imminently hazardous situation that, if not avoided, will result in death or serious injury. Includes hazards that are exposed when guards are removed.



WARNING: Indicates a potentially hazardous situation that, if not avoided, could result in serious injury or death. Includes hazards that are exposed when guards are removed.



CAUTION: Indicates a potentially hazardous situation that, if not avoided, could result in minor or moderate injury.



IMPORTANT: Indicates information about procedures that, if not observed, could result in damage to equipment or corruption to and loss of data.

General Safety



Do not operate or work on this equipment unless this manual has been read and all instructions are understood. Failure to follow the instructions or heed the warnings could result in injury or death. Contact any Rice Lake Weighing Systems dealer for replacement manuals.



WARNING

Failure to heed could result in serious injury or death.

Some procedures described in this manual require work inside the indicator enclosure. These procedures are to be performed by qualified service personnel only.

Do not allow minors (children) or inexperienced persons to operate this unit.

Do not operate without the enclosure completely assembled.

Do not use for purposes other than weight taking.

Do not place fingers into slots or possible pinch points.

Do not use this product if any of the components are cracked.

Do not exceed the rated specification of the unit ([Section 12.0 on page 91](#)).

Do not make alterations or modifications to the unit.

Do not remove or obscure warning labels.

Do not submerge.

1.3 FCC Compliance

United States

This equipment has been tested and found to comply with the limits for a Class A digital device, pursuant to Part 15 of the FCC Rules. These limits are designed to provide reasonable protection against harmful interference when the equipment is operated in a commercial environment. This equipment generates, uses, and can radiate radio frequency energy and, if not installed and used in accordance with the instruction manual, may cause harmful interference to radio communications. Operation of this equipment in a residential area is likely to cause harmful interference in which case the user will be required to correct the interference at his own expense.

Canada

This digital apparatus does not exceed the Class A limits for radio noise emissions from digital apparatus set out in the Radio Interference Regulations of the Canadian Department of Communications.

Le présent appareil numérique n'émet pas de bruits radioélectriques dépassant les limites applicables aux appareils numériques de la Class A prescrites dans le Règlement sur le brouillage radioélectrique édicté par le ministère des Communications du Canada.

1.4 Disposal



Product Disposal

The product must be brought to appropriate separate waste collection centers at the end of its life cycle.

Proper separate collection to recycle the product helps prevent possible negative effects on the environment and to health, and promotes the recycling of the materials. Users who dispose of the product illegally shall face administrative sanctions as provided by law.

Battery Disposal

Dispose of batteries at appropriate waste collection centers at the end of their life cycle in accordance with local laws and regulations. Batteries and rechargeable batteries may contain harmful substances that should not be disposed of in household waste. Batteries may contain harmful substances including but not limited to: cadmium (Cd), lithium (Li), mercury (Hg) or lead (Pb). Users who dispose of batteries illegally shall face administrative sanctions as provided by law.



WARNING: Risk of fire and explosion. Do not burn, crush, disassemble or short-circuit lithium batteries.

1.5 FM Approval

The 882IS/882IS Plus is a FM Entity approved for:

- Classes I, II and III
- Division 1
- Groups A, B, C, D, E, F and G
- Class I, Zone 0, AEx/EX ia IIC
- Zone 0/20
- Zone 20 AEx ia IIIC
- IP66
- T-rating T4 = 14–104°F (-10–40°C)

Only devices that have FM Entity Approval with proper entity parameters may be used unless specifically listed in this manual or control drawings (PN 77412, PN 180848 and PN 182301) as part of the Rice Lake Weighing Systems FM systems approval. Failure to comply with this voids the FM approval.

This classification of hazardous materials are different in the US and European standards, because of this, the safety class of the 882IS/882IS Plus is declared in the US standards: Class I, II, III, DIV1 and Groups A-G.

Substitution of components may impair intrinsic safety.

To prevent ignition of flammable or combustible atmospheres, disconnect power before servicing.

Disconnect all power to this unit before installing, servicing or cleaning. Failure to do so could result in bodily harm and/or property damage.

The 882IS/882IS Plus has been certified by UL (U.S., Canada, ATEX and IECEx) with a temperature rating of 14–104°F (-10–40°C) for use in hazardous environments where auto ignition temperature of the hazardous material is below the rating.

Do not install, disconnect or perform any service on this equipment before power has been switched off or the area has been secured as non-hazardous by personnel authorized to do so by the responsible person on-site.

1.6 Hazardous Location Labels

The following labels will be affixed to the 882IS/882IS Plus.

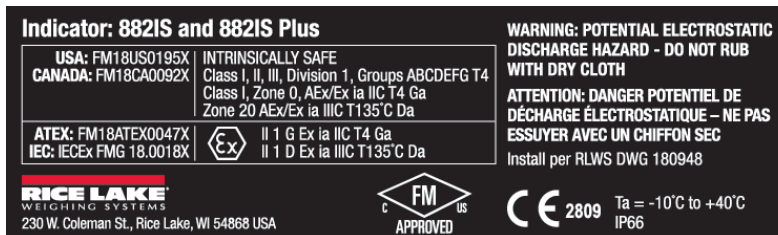

Figure 1-1. 882IS/882IS Plus Indicator Label



Figure 1-2. IS6V2 Battery Label

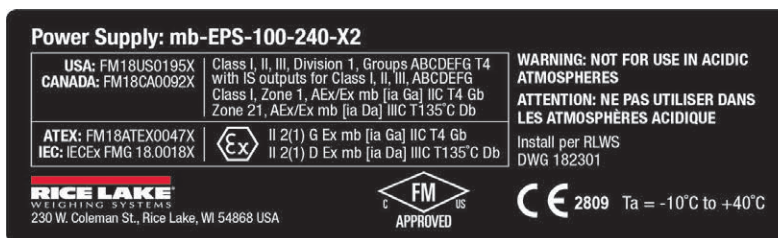

Figure 1-3. mb-EPS-100-240-X2 Power Supply Label

1.7 Operating Modes

The three modes of operation for the 882IS/882IS Plus are described below.

Weigh Mode

In this mode, the indicator displays gross or net weights to indicate the type of weight value displayed, and annunciators to indicate scale status.

Setup Mode

Most of the procedures described in this manual, including setup and calibration, require the indicator to be in **Setup** mode. To enter setup mode, remove the fillister head screw from the bottom of the enclosure. Insert a non-conductive tool into the access hole and press the setup switch once. the indicator display changes to show the word **Scale**.

! IMPORTANT: Breaking the seal to enter the Configuration mode will void a Legal for Trade unit.

The 882IS/882IS Plus also has an Audit Trail that can track changes to setup and calibration, allowing the setup switch to be bypassed with Jumper JP4 on the CPU board. If Audit Trail is enabled, setup mode can then be accessed through the **User Setup** mode.

User Setup Mode

User Setup mode (accessed by pressing the ) is used to:

- View the audit trail, set time & date
- View or clear the accumulator value
- View the current tare value
- Enter **Setup/Configuration** mode (if audit trail is enabled)

1.8 Front Panel Display

Figure 1-5 shows the iRev 4 front panel display and Table 1-3 describes the key functions.

The numeric or weight portion of the display consists of the seven-segmented LCD digits and below that, is a messaging area of the display which is the dot matrix and can display two-line non-configurable messages (ie: error messages).

The symbols on the keys in Figure 1-4 and Figure 1-5 (representing up, down, enter, left, right) describe the key functions when in **Configuration/Setup** mode. The keys are used to navigate through menus, select digits within numeric values, and increment/decrement values. See Section 3.2 on page 30 for information about using front panel keys in **Configuration** mode.

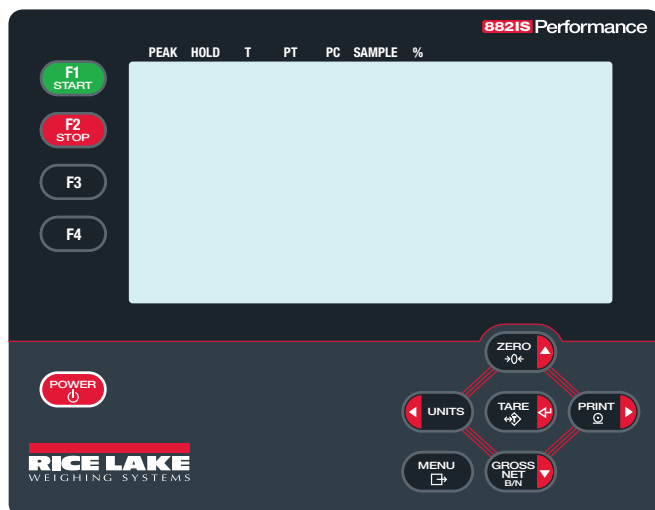

Figure 1-4. 882IS Front Panel Display

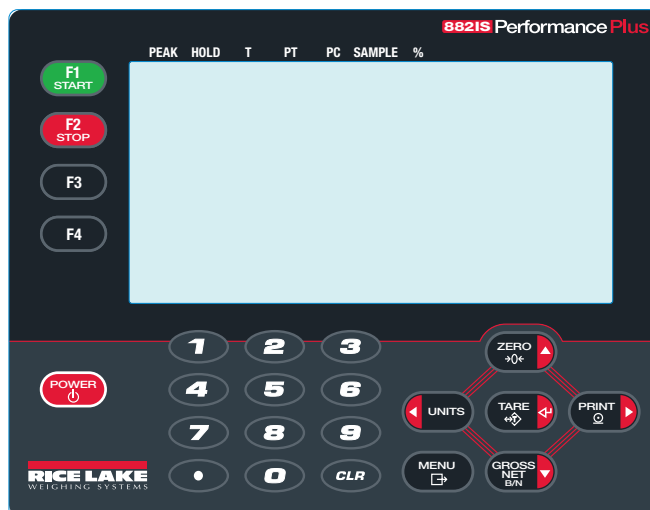

Figure 1-5. 882IS Plus Front Panel Display

Key	Function
	The Zero key sets the current gross weight to zero; Also used as the up key to navigate menus
	The Print key sends an on-demand print format out a communications port, provided the conditions for standstill are met; If enabled in configuration, Print may display while the unit prints; Also used as the right key to navigate menus or to select another digit when editing a value
	The Gross/Net key toggles the weight display between Gross and Net mode; If a tare value has been entered or acquired, the net value is the gross weight minus the tare; Gross mode is shown by the Gross/Brutto annunciator; Net mode is shown by the net annunciator; Also used as the down key to navigate menus
	The Menu key allows access the User Setup menu; This key also acts as the cancel key when editing parameter values, or as an exit key when in the Configuration or User Setup menus
	The Units key switches the weight display to an alternate unit, defined in the format menu (Figure 3-7 on page 33); Units Available: lb, kg, oz, metric ton, ton, gram; Also used to navigate to different menus or to toggle to another digit when editing a value
	The Tare key performs one of several predetermined Tare functions dependent on the mode of operation selected in the Tare Function parameter; This key also acts as the Enter key for numeric or parameter entry
	The Power key turns the unit on or off; Press and hold to turn on, press momentarily to turn off
	Future enhancement

Table 1-3. 882IS/882IS Plus Key Functions







Key	Function
	Future enhancement
	Future enhancement
	Future enhancement
	The Clear key clears the current value during a numeric entry (available in the 882IS Plus)
	The Decimal Point key inserts a decimal point where necessary (available in the 882IS Plus)
	The numeric keypad can be used to enter values (available in the 882IS Plus)

Table 1-3. 882IS/882IS Plus Key Functions (Continued)



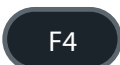







Annunciator	Function
Gross/Brutto	Gross or Brutto weight mode
Net	Net weight mode
	Center of Zero - Indicates that the current gross weight reading is within ± 0.25 display divisions of the acquired zero, or is within the center of zero band; A display division is a resolution of the displayed weight value, or the smallest incremental increase or decrease that can be displayed or printed
	Standstill - The scale is at a standstill or within the specified motion band; Some operations including zero, tare and printing can only be done when the standstill LCD is on
Peak Hold	Future enhancement
T	Indicates that a tare has been acquired and stored by the system
PT	Indicates that a preset tare weight has been keyed in or entered via the EDP command
PC	Future enhancement
Sample	Future enhancement
%	Future enhancement

Table 1-4. Annunciator Functions



1.9 General Navigation

The front panel keys are used to navigate through the menus in **Configuration** mode ([Section 3.0 on page 29](#)).

-  and  move left and right (horizontally) in a menu level
-  and  move up and down (vertically) to different menu levels
-  serves as the **Enter** key for selecting parameter values within the menus

Press  or  to scroll left or right until the desired menu group appears on the display. Press  to move down to the sub-menu or parameter to be edited. When moving through the menu parameters, the current selected value appears first on the display.

1.9.1 Edit Parameter Values

To change a parameter value, scroll left or right to view the values for that parameter. When the desired value appears on the display, press  to select the value and move back up one level. To edit numerical values, use the navigation keys to select the digit and to increment or decrement the value. Alternatively, use the numeric keypad (882IS Plus), to enter the digits. The decimal point will begin flashing if a decimal value is allowed. Use the navigation keys, to move the decimal point left or right. Press  when done.

1.9.2 Alphanumeric Entry Procedure

Use the following navigation path for alphanumeric entry when using the five button keypad.

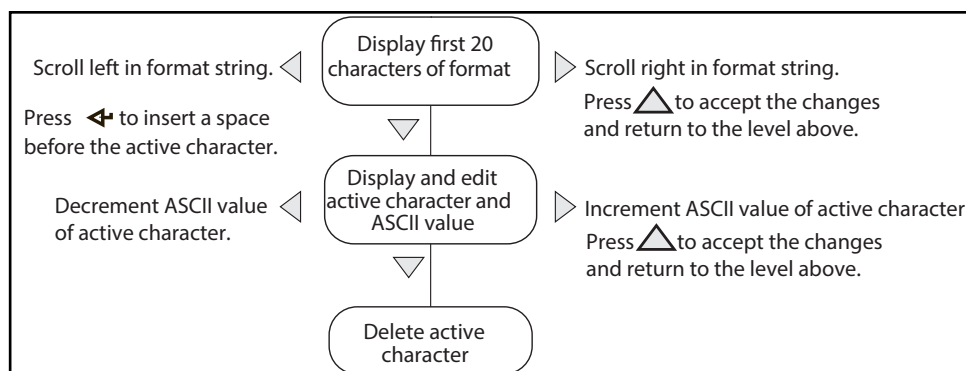



Figure 1-6. Editing Procedure for Numeric Values

1.10 Indicator Operations

Basic 882IS/882IS Plus operations are summarized below.

1.10.1 Toggle Gross/Net Mode



Press  to toggle the display mode between gross and net.

 **NOTE:** Net mode is available when a tare value has been entered or acquired (Net = Gross minus Tare). If a tare has not been entered or acquired, the display remains in Gross mode. The B (Brutto), G (Gross) or NET icons on the LCD indicate the current mode.

1.10.2 Toggle Units



Press  to switch between primary and secondary units. The current units are displayed on the LCD.

1.10.3 Zero Scale

1. In **Gross** mode, remove all weight from the scale and wait for  to display.
2. Press .  displays and indicates the scale is zeroed.

 **NOTE:** The scale must be stable and within the configured zero range for the scale to be zeroed. If the scale cannot be zeroed, no zero will display.

1.10.4 Acquire Tare

1. Place a container on the scale and wait for  to display.
2. Press  to acquire the tare weight of the container. The Net weight displays and the T annunciator displays to show the tare value is entered.

1.10.5 Remove Tare Value

1. Remove all weight from the scale and wait for . The display reads $\rightarrow 0 \leftarrow$.
2. Press to zero the scale if needed.
3. Press (or in OIML mode). The display shifts to gross weight and the Gross icon is lit.
4. To clear the tare, press again.

1.10.6 Preset Tare (Keyed Tare)



NOTE: If keyed tares are allowed, press to open the keyed tare prompt.

Tare mode must be set to keyed or both for the preset tare feature to function.

1. With scale empty and zero weight displayed, press . **One flashing 0** displays with the focused digit flashing.
2. Key in the value using the keypad on the 882IS Plus ([Section 1.10 on page 15](#)).
 - Press or to select the digit
 - Press or to increment or decrement the value
 - Press to move to the decimal point entry
 - Press or to adjust the decimal point placement
 - Press when the value is correct



NOTE: The display will change to the Net mode and PT lights to show the preset tare was entered. Entering a keyed tare of zero will remove the stored tare value.

1.10.7 Print Ticket

1. Wait for to light.
2. Press to send data to the configured communications port.

1.10.8 Front Panel User Setup







Press to enter **User Setup** mode. Use **User Setup** mode to:

- View audit trail information
- Enter **Configuration** mode if audit trail is enabled
- View or clear the accumulator
- View the current tare value
- Time and date
- Test menu

1.10.9 Displaying Audit Trail Information



The Audit Trail Configuration and Calibration counters can be viewed in **User Setup** mode.

1. Press . **Audit** displays.
2. Press to display the Legally Relevant Firmware version.
3. Press to display **Calibration**.

4. Press  to view the Calibration Counter.
5. Press  to return to **Calibration**.
6. Press  to display **Configuration**.
7. Press  to view the Configuration Counter.
8. Press  to return to **Configuration**.
9. Press  to return to the **Weigh** mode.





1.10.10 Display Accumulator

Enable the accumulator before use in **Weigh** mode. Once enabled, weight (net weight if a tare is in the system) is accumulated whenever a print operation is performed using the **Print** key, digital input, or **KPRINT** EDP command. The scale must return to below the threshold value before the next accumulation.









1. Press  to enter the **User Setup** mode, **Audit** displays.
2. Press  or  until **Accumulator** displays.



NOTE: Accumulator is only displayed if the accumulator is enabled (Section 3.2.4 on page 31). The Print operation only performs one accumulation, and only if the weight is above the accumulator threshold. Weight must return to below the accumulator threshold value before another accumulation is allowed. The EDP command SC.THRESH#n is configured in the setup menu (Section 3.2.4 on page 31).

3. Press . **View** displays.
4. Press  to view the current accumulator value.
5. While the accumulator value displays, press  to print the value.
6. Press  to return to the **Weigh** mode.

1.10.11 Clear the Accumulator

1. Press  to enter the **User Setup** mode. **Audit** displays.
2. Press  or  until **Accumulator** displays.
3. Press , then press  or  until **Clear Accumulator** displays.
4. Press  to clear the accumulator. **Clear** will display briefly and display returns to **Clear Accumulator**.
5. Press  to return to the **Weigh** mode.

1.10.12 Display Tare

When a tare value displays, the Gross and Net icons will be off and $\rightarrow 0 \leftarrow$ is lit. To display a tare:

1. Press .
2. Press  to **Tare** and press  to view the current tare value.
3. Press  twice to return to **Weigh** mode.



NOTE: If there is not a tare in the system, the value displayed is zero and the Gross and Net icons are turned off.

2.0 Installation

This section describes procedures for connecting power, load cells, digital inputs and data communications cables to the 882IS and 882IS Plus indicator.



IMPORTANT: Use anti-static protection for grounding and to protect components from electrostatic discharge (ESD) when working inside the indicator enclosure.

Procedures requiring work inside the indicator must be performed by qualified service personnel only.

Disconnect the indicator from power source before opening enclosure.

Component level repair, excluding board-swapping, is not permitted on FM Approved equipment by anyone other than the manufacturer. It is mandatory to return unit to Rice Lake Weighing Systems for repairs.

The entire indicator must be shipped back to Rice Lake Weighing Systems for repair. Please contact a local dealer or Rice Lake Weighing Systems to obtain a return material authorization (RMA). There are no user serviceable parts within the unit except CPU board replacement. All repairs are to be performed by qualified service personnel only.

2.1 Unpacking and Assembly

Immediately after unpacking, visually inspect the unit to ensure all components are included and undamaged.

The shipping carton should contain the indicator and manual. If any parts were damaged in shipment, notify Rice Lake Weighing Systems and the shipper immediately.

2.2 Product Dimensions

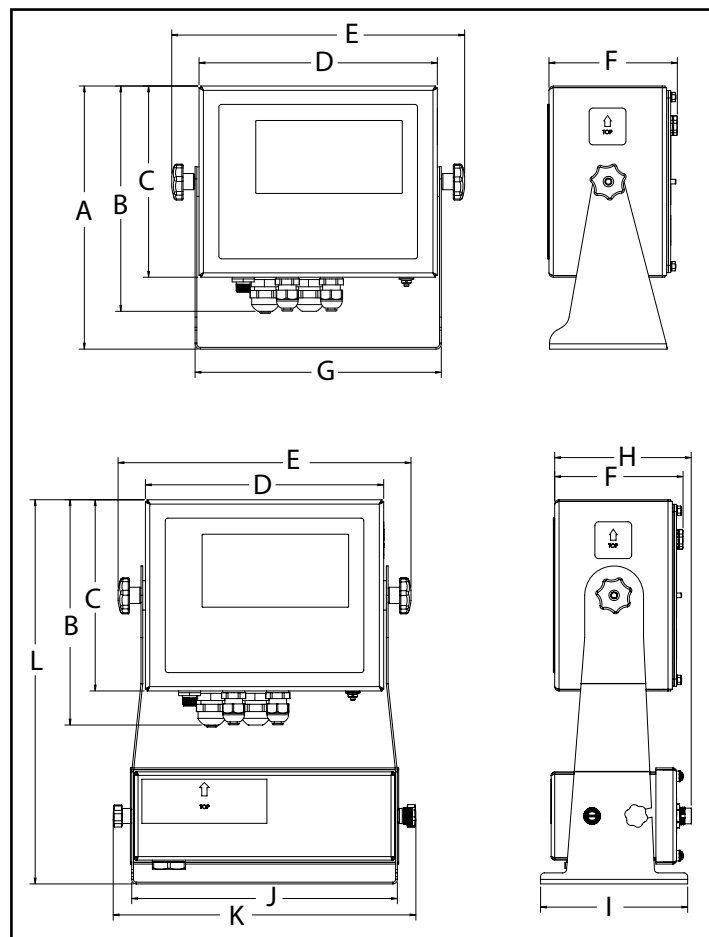

Figure 2-1. Product Dimensions (Universal and Optional Battery Versions Shown)

Dimensions Without Battery	
A	8.94" (227.1 mm)
B	7.66" (194.6 mm)
C	6.50" (165.1 mm)
D	8.10" (205.7 mm)
E	9.96" (253 mm)
F	4.36" (110.7 mm)
G	8.37" (212.6 mm)
Dimensions with Optional Battery and Tilt Stand	
H	4.64" (117.9 mm)
I	5.00" (127 mm)
J	9.03" (229.4 mm)
K	10.29" (261.4 mm)
L	13.06" (331.7 mm)

Table 2-1. Product Dimensions

2.3 Hazardous Area Installation

The following information is provided to help the installer with the correct installation of the 882IS/882IS Plus system. See the following diagram of a typical intrinsically safe system.

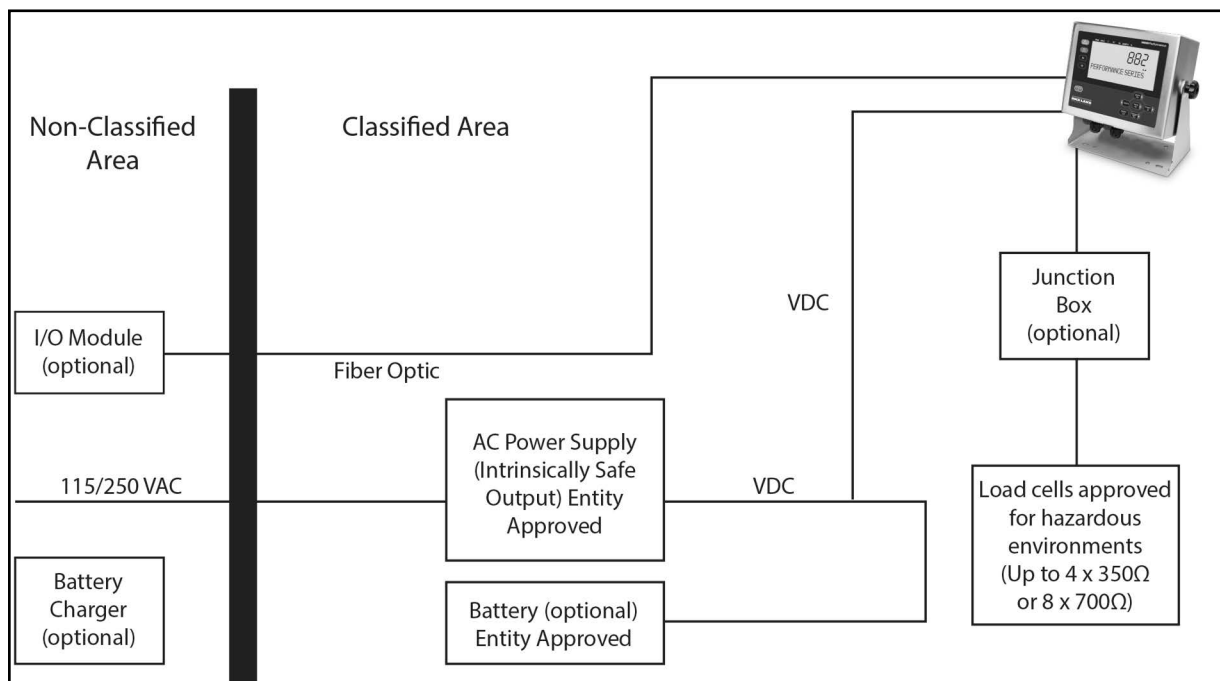

Figure 2-2. Intrinsically Safe System Diagram Example

2.4 Mounting Instructions

The 882IS/882IS Plus includes a universal mount. The universal mount can be mounted on a wall, tabletop or any flat surface.



NOTE: The universal mount comes attached to the unit. Rice Lake Weighing Systems recommends removing the 882IS/882IS Plus from the universal mount prior to mounting.

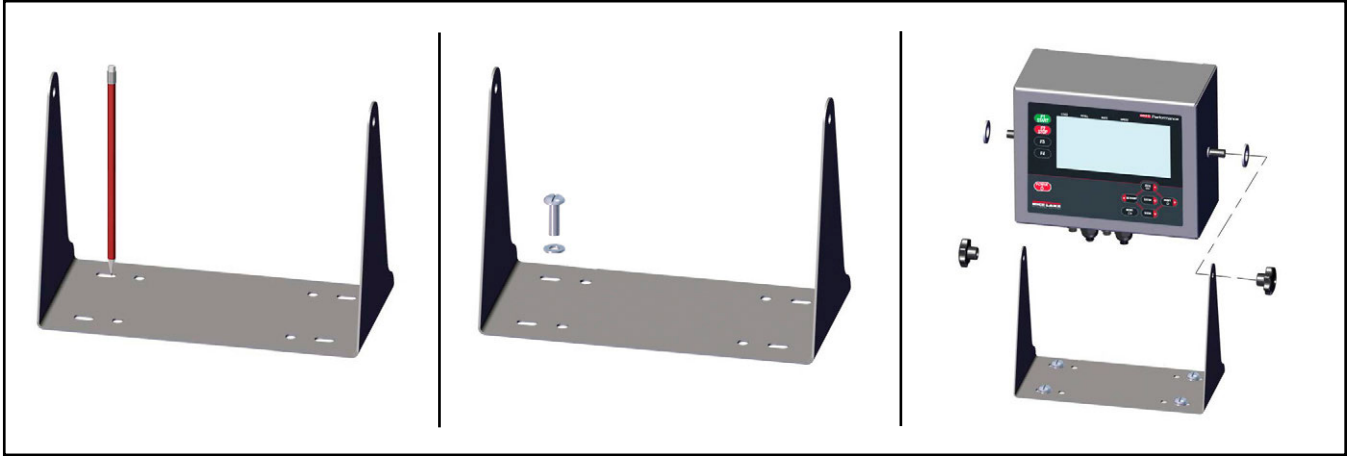

Figure 2-3. Mounting the 882IS/882IS Plus

1. Using the mount as a template, mark the screw locations.
2. Drill holes for the screws.
3. Secure the universal mount using the appropriate length 1/4" or M6 hardware (not included).
4. Reattach the 882IS to the universal mount.

2.4.1 Backplate Removal

Remove the backplate of the universal mount assembly to gain access to the inside of the enclosure and CPU board.

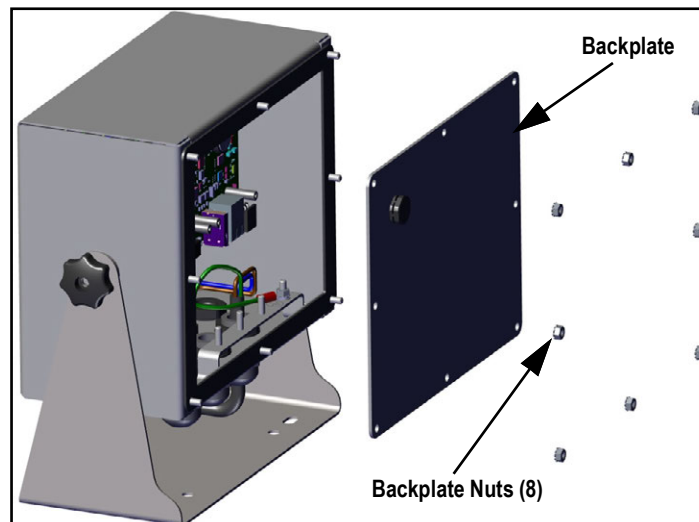

Figure 2-4. Remove Enclosure Backplate

1. Remove the nuts that attach the backplate to the enclosure.



NOTE: The unit ships with Backplate Nut (4) installed.

2. Remove the backplate.



WARNING: Disconnect power to the indicator prior to removing the backplate.

2.5 Cable Connections on the 882IS

The 882IS has four cord grips at the bottom of the enclosure for cabling into the enclosure. One stainless steel cord grip is used for the power supply and other cord grips are for the load cell cable, communications and the fiber optic cable. Two of the four cord grips come with a plug installed to prevent moisture from entering the enclosure. Depending on the application, remove the plug from the cord grip that will be used and install cables as required. [Figure 2-5](#) shows the recommended 882IS cord grip assignments.

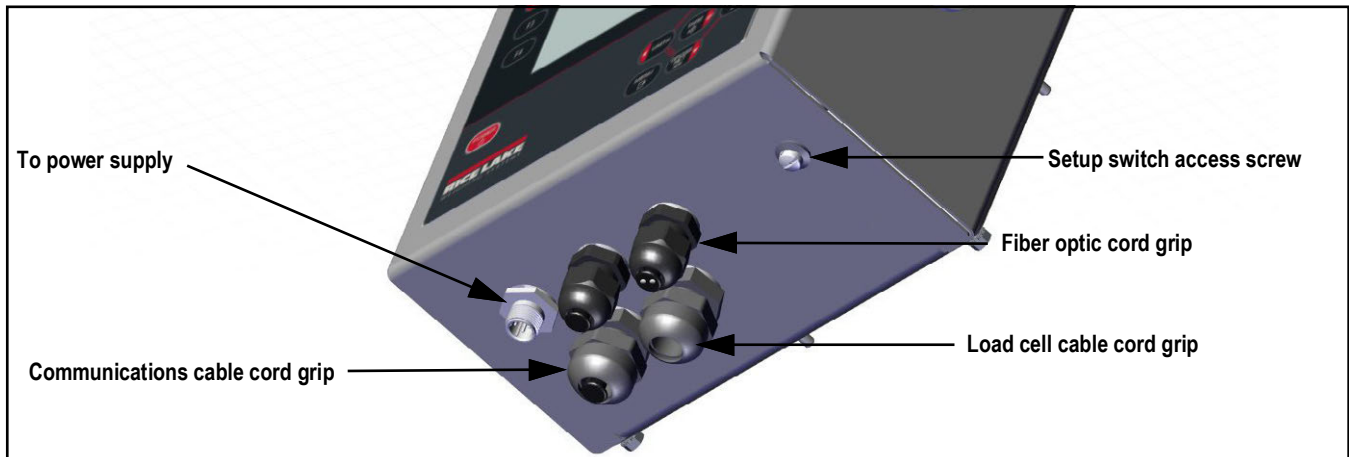

Figure 2-5. Recommended Cord Grip Assignments

2.5.1 Cord Grip Specifications

Cord Grip	Diameter Range
PG9 (PN 15626)	0.138 - 0.315" (3.5 - 8 mm)
PG11 (PN 68600)	0.197 - 0.394" (5 - 10 mm)

Table 2-2. Cord Grip Diameter Ranges

Torque	in-lb	Nm
Cord grip nut (to enclosure)	33	3.7
Cord grip dome nut (around cable)	22	2.5

Table 2-3. Cord Grip Torque Values

2.5.2 Power Supply to Indicator



WARNING: Do not under any circumstances, connect or disconnect the DC wire from the indicator while the AC power is applied to the power supply. This will cause the power supply fuse to blow.

The 882IS/882IS Plus must be powered by an FM-approved Rice Lake power supply or optional battery.

The power requirements of the 882IS indicator are as follows:

- Minimum input voltage – 5.8 VDC
- Maximum input voltage – 7.9 VDC
- Peak current consumption – .25 W
- Average input current (with four load cells) – 100-175 mA



NOTE: The DC power cable should be attached to connector J4 ([Figure 2-9 on page 24](#)).

2.5.3 AC Power Wiring

Units are powered by an FM-approved power supply. 100-240 VAC into Rice Lake Weighing Systems mb-EPS-100-240-X2 intrinsically safe power supply is recommended. See the mb-EPS-100-240-X2 Power Supply Instruction sheet (PN 194894) for information on wiring and power specifications.

2.5.4 Battery Option

The optional IS6V2 battery (PN 180831) provides an intrinsically safe battery that can replace the power supply. The battery is approved for use in hazardous environments. A low battery error message displays on the 882IS to indicate that the battery needs to be recharged. A fully charged battery is one that has been charged for a minimum of 12 hours.



NOTE: To keep the battery at full capacity, it is recommended to leave the battery connected to the charger, in float charge mode, until ready to use. The battery can remain on the charger in float charge mode indefinitely without damaging the battery. See 882IS IS6VS Battery Instructions (PN 194893) for instructions on charging the battery.

Load Cell Size	Quantity of Cells	Estimated Operating Time
350 Ohm Load Cell	1	80-95 hours
	4	60-80 hours
700 Ohm Load Cell	1	85-100 hours
	4	70-90 hours

Table 2-4. Estimated Battery Operating Times



NOTE: While connected to the DC battery pack with the indicator off, the 882IS still draws a small amount of current that will shorten battery run time. To preserve battery life, disconnect the battery when not in use.

2.5.5 Load Cells

To attach a cable from a load cell or junction box, route the cable to the J1 connector. Wire the load cell cable from the load cell or junction box to connector J1 as shown in Table 2-5. If using 6-wire load cell cable (with sense wires), open the unit (see Section 2.4.1 on page 20) and remove jumpers JP1 and JP2.



NOTE: For 4-wire installation, leave jumpers JP1 and JP2 on (Figure 2-10 on page 25). Ensure Pins 3 and 4 are left empty for a 4-wire installation.

Connector	Pin	Function
J1	1	+SIG
	2	-SIG
	3	+SENSE
	4	-SENSE
	5	+EXC
	6	-EXC

For 6-wire load cell connections, remove jumpers JP1 and JP2.

Table 2-5. J1 Pin Assignments



NOTE: The shield wire will attach to the ground clamp on the backplate.

2.5.6 Cable Shield Grounding

Except for the power cord, all cables routed through the cord grips must be shield grounded against the enclosure.

- Use hardware provided in the parts kit to install shielding clamps on the grounding studs at the bottom of the enclosure
- Install only the necessary amount of shielding clamps for the cord grips to be used; finger tighten nuts at this time
- Route cables through the cord grips and shielding clamps to determine the cable lengths required to reach the appropriate cable connectors
- Mark the cables to remove the insulated jackets and shielding as described in the next two sections

Foil Shielded Cable

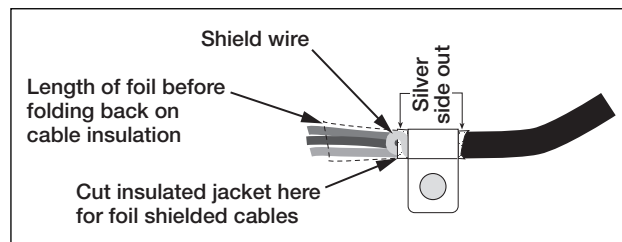

Figure 2-6. Foil Shielded Cable

1. Strip the insulated jacket and foil 1/2" (15 mm) past the shielding clamp.
2. Strip another 1/2" of the insulated jacket, leaving the foil shielding exposed.
3. Fold the foil shielding back on the cable where the cable passes through the clamp.
4. Ensure the silver (conductive) side of the foil is turned outward.
5. Wrap the shield wire around the cable so it contacts the foil where the cable passes through the clamp.
6. Torque the shielding clamp nut to 10 in-lb (1.13 N-m) so the clamp is around the cable and contacting the shield wire.

Braid Shielded Cable

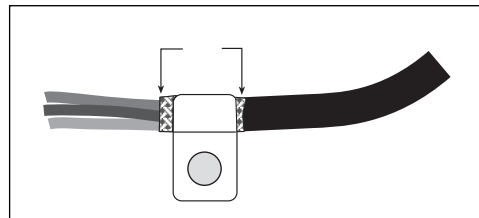

Figure 2-7. Braid Shielded Cable

1. Strip the insulated jacket and braided shielding from a point just past the shielding clamp.
2. Strip another 1/2" (15 mm) of the insulated jacket, leaving the braid exposed where the cable passes through the clamp.
3. Tighten the shielding clamp nut.

2.5.7 CPU Board Replacement

1. Disconnect power to the indicator.
2. Remove the backplate from the enclosure ([Section 2.4.1 on page 20](#)).



NOTE: Label connections for re-installation of board.

3. Disconnect cables from the CPU board.
4. Remove the four screws from the CPU board.
5. Lift the CPU board out of the enclosure.



NOTE: To install the new board, reverse the above procedure. Be sure to reinstall cable ties to secure all cables inside the indicator enclosure.

DC Cable Grounding in 882IS

To ground the DC cable, see the following information:

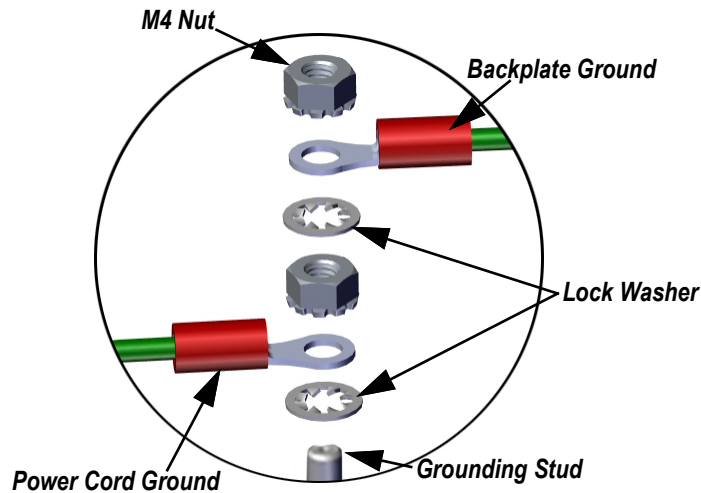

Figure 2-8. DC Grounding Stackup

1. Run DC power cable (not included) up through the cord grip.
2. Run three (not included) 22-16 AWG wires (5-10 mm diameter) up through the cord grip.
3. One wire will be terminated (grounded) at a stud near the cord grip using the grounding stackup (Figure 2-8).
4. Run the other two wires up the side of the indicator and connect the three pin plug (PN 15888) to the power supply board as shown in Figure 2-9 and Table 2-6 on page 24.

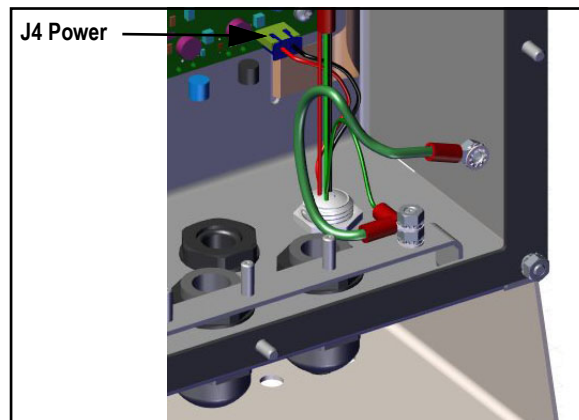

Figure 2-9. Connect DC Wiring

2.5.8 Serial Communications - Port 1 (COM)

Connector J3A (Figure 2-10 on page 25) provides connections for the four-wire RS-422 serial communications. Figure 2-6 shows the pin assignments.

Pin	RS-422
1	GND
2	DRX (-)
3	DRX (+)
4	DTX (-)
5	DTX (+)

Table 2-6. J3A Pin Assignments (Port 1 Serial Communications)

2.6 CPU Board

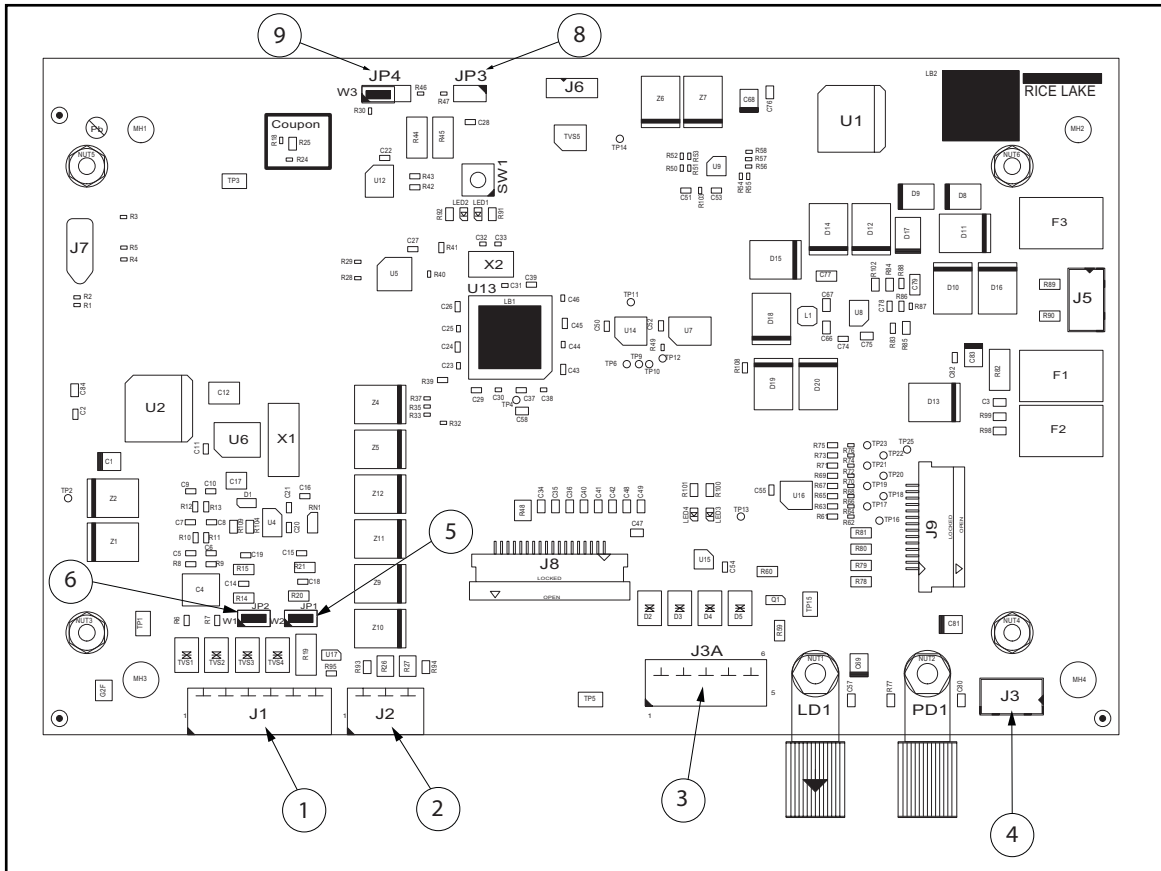

Figure 2-10. 882IS CPU Board

Item No.	Connector	Description
1	J1	Load Cell Connection
2	J2	Digital Input
3	J3A	Communication RS-422
4	J3	Power Connection
5	JP1	Load Cell Sense
6	JP2	
8	JP3	Configuration/Setup
9	JP4	Audit Trail

Table 2-7. CPU Board Connectors

2.7 Audit Trail

The 882IS includes an audit trail feature that keeps track of the calibration count and the configuration count.

On the top of the CPU board is a 3-pin jumper (JP4) that enables or disables this feature. If the jumper is set to on, the 882IS allows entry to the setup and calibration menus using only the front panel **Menu** key.

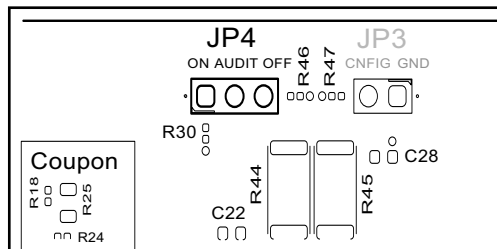

Figure 2-11. Audit Trail Jumper Position

- To use the audit trail and allow the use of the **Menu** key to enter the configuration and calibration mode, place the jumper in the **On** position
- To prevent the use of the **Menu** key to enter the configuration and calibration mode, instead requiring use of the externally seal-able setup switch located inside the enclosure (Figure 3-1 on page 29), place the jumper in the **Off** position

The audit trail counters operates in either position of the audit jumper.

2.8 Digital Inputs

Digital inputs can be set to provide many indicator functions, including all keypad functions except MENU. Digital inputs are active low (0 VDC) and inactive high (5 VDC). Use the Digital Inputs menu (Section 3.2.16 on page 43) to configure the digital inputs.

Table 2-8 shows the digital inputs pin assignments for connector J2.

Connector	Pin	Signal
J2	1	GND
	2	DI2
	3	DI1

Table 2-8. J2 Pin Assignments (Digital Inputs)

2.9 Backplate Attachment

Once cabling is complete, reattach the backplate ground wire to the backplate. Position the backplate over the enclosure and install the eight backplate nuts. Use the torque pattern shown in Figure 2-12 to prevent distorting the backplate gasket. Torque nuts to 15 in-lb (1.7 N-m).

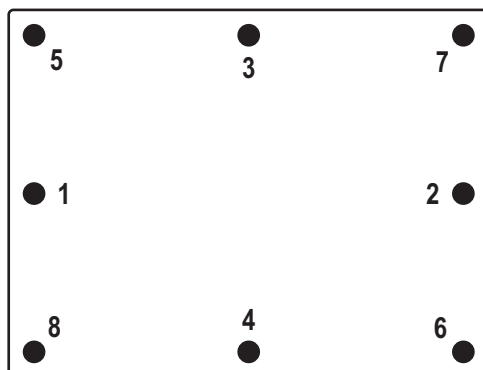

Figure 2-12. Torque Pattern

2.10 Legal for Trade Sealing

In certain Legal for Trade applications, it may be necessary to seal the indicator to restrict access from the setup switch. Use the following steps to seal the indicator.

1. Place the sealing wire through the fillister head screws on the backplate, then through the fillister head screw at the bottom of the indicator, as shown in [Figure 2-13](#).
2. Seal the wire to secure.

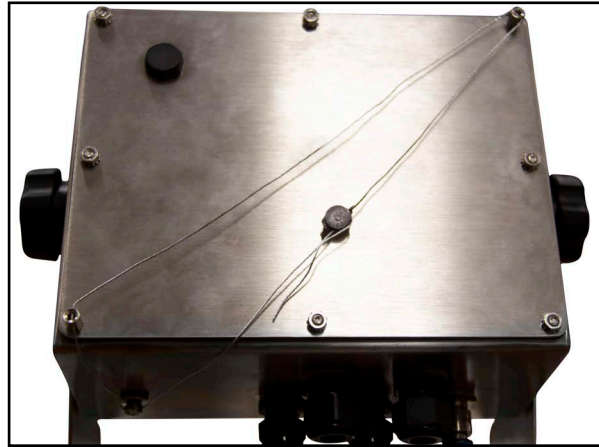

Figure 2-13. Sealing the Indicator

2.11 IO Module Option Cards

The following interfaces are available through an IO module connected to the 882IS via fiber optics.

Connector J8 is reserved for the option cards. [Table 2-9](#) lists the options available for the 882IS indicator. Each kit includes instructions for installing and setting up the option.

Part No.	Option Kit	Manual Part No.
190528	Analog Output	156858
190535	EtherCat	195260
190530	EtherNet/IP	
190532	ProfiNet	
190533	Modbus TCP	
190532	DeviceNet	
190534	Profibus DP	

Table 2-9. Available Option Cards

2.12 Rechargeable Battery Usage

The 882IS uses an optional, FM approved, rechargeable, IS6V2 battery (PN 180831). When the battery voltage on connector J3 reaches approximately 5.55 volts, the indicator display shows **Low Battery Life Replace or Charge**. Replace/recharge the battery when this warning displays to prevent data loss before a complete shutdown. Battery life will vary depending on use and power saving mode ([Section 3.2.18 on page 49](#)). To preserve battery life, disconnect the battery when not in use.



NOTE: Even if the 882IS is turned off, the indicator still draws a small amount of power while connected.



NOTE: For additional IS6V2 battery pack information, see the 882IS IS6VS Battery Instructions (PN 194893).

2.13 Replacement Parts

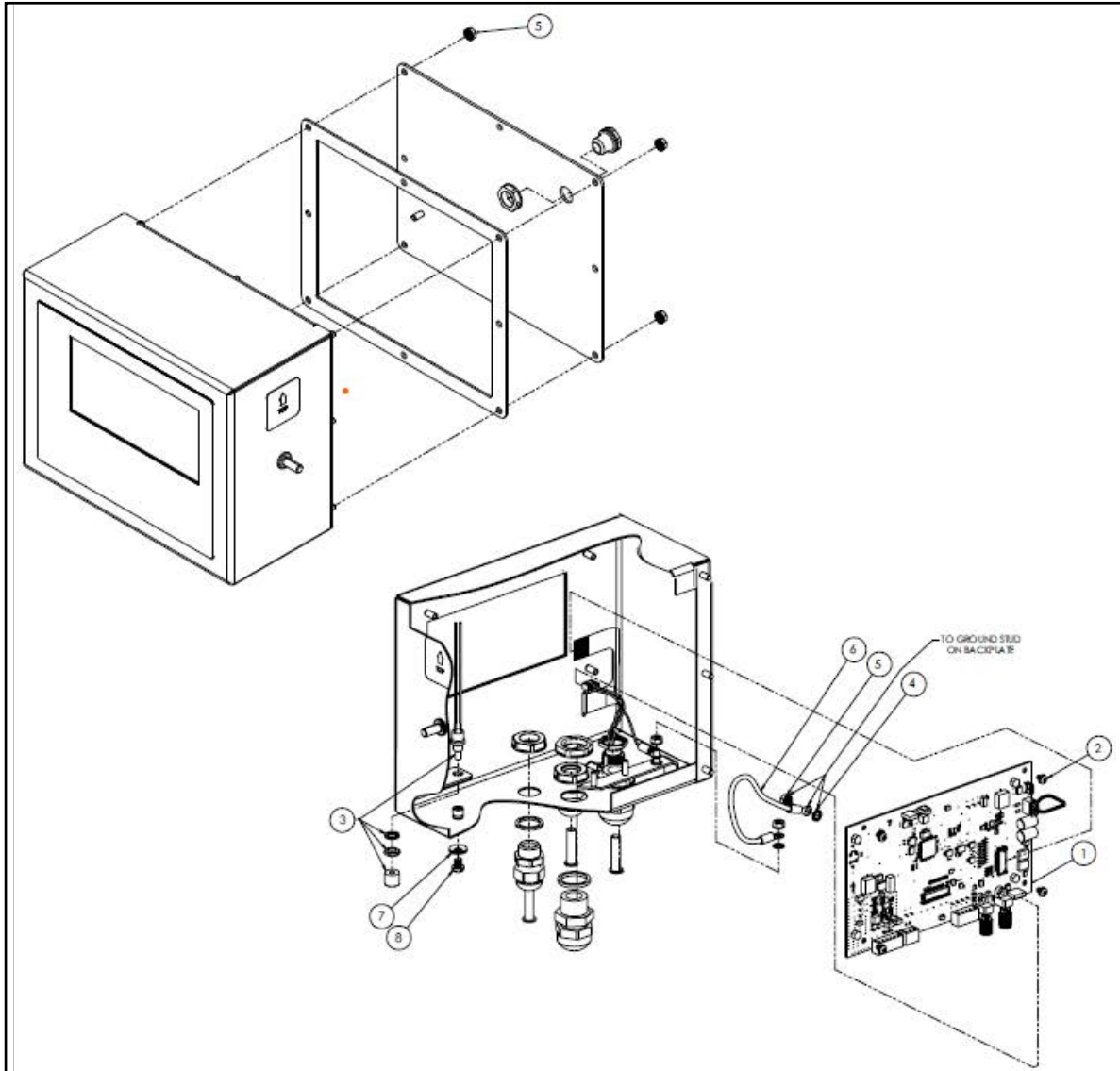

Figure 2-14. 882IS Indicator Parts Drawing

Item No.	Part No.	Description	Qty.
1	221062	Board Assembly, CPU 882IS Display, ROHS Compliant	1
2	180824	Machine Screw, Phillips Pane Head 18-8 SST	4
3	44845	Setup Switch Assembly	1
4	180856	Washer, M4 Internal Tooth SST	3
5	180826	Nut, Kep External Tooth Lock Washer 18-8 SST	7
6	15601	Ground Wire 6" with Number 8 Eye Connector	1
7	46381	#10 Bonded Sealing Washer, 18-8 Stainless Steel	1
8	180861	Screw, Machine Slotted Drilled Cheese Head, SST	1

Table 2-10. 882IS Replacement Parts for PN 177707 and PN 180829

3.0 Configuration

To configure the 882IS/882IS Plus indicator, the indicator must be placed in setup mode. The setup switch is accessed through a small hole on the bottom of the enclosure. Insert a non-conductive tool into the access hole and press the setup switch to put the indicator into setup mode.



IMPORTANT: Use caution when inserting the non-conductive tool into the bottom of the enclosure. Only press the tool in about 3/4" (19 mm) to engage the setup switch. Do not use excessive force that may damage the switch.



NOTE: If the audit trail is enabled, setup mode may be accessed by pressing .

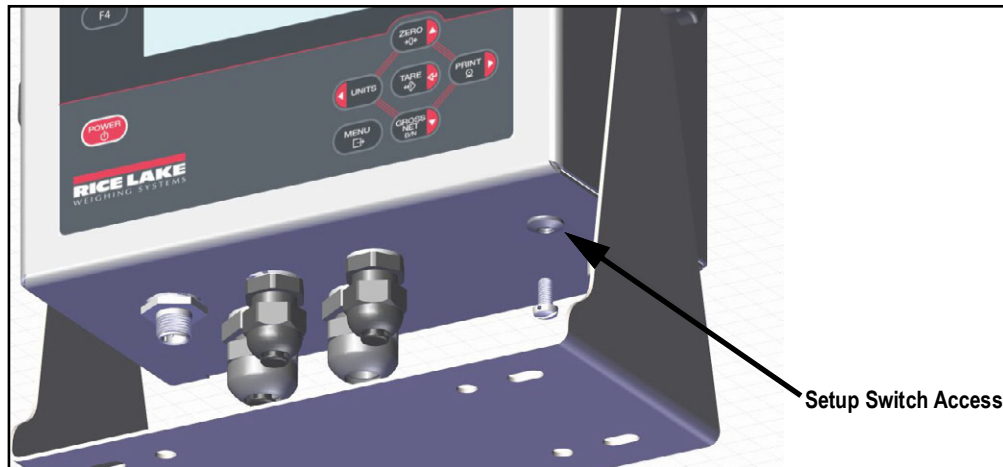

Figure 3-1. Bottom View – Setup Switch Access

When the indicator is placed in setup mode, the word **Scale** displays. The **Scale** menu is the first of eight second-level menus used for configuring the indicator. Detailed descriptions of these menus are given in [Section 3.2.3 on page 31](#).

When setup is complete, press  to return to the **Weigh** mode.

3.1 Configuration Methods

The 882IS/882IS Plus indicator can be configured by using the front panel keys to navigate through a series of configuration menus or by sending commands or configuration data to the data communication port. Configuration using the menus is described in [Section 3.2 on page 30](#).

Configuration using a data communication port can be accomplished using either the EDP command set ([Section 6.0 on page 59](#)) or the Revolution configuration utility ([Section 5.2 on page 58](#)).

3.2 User Setup Menu

The 882IS/882IS Plus indicator can be configured using a series of menus accessed through the indicator front panel. [Table 3-1](#) summarizes the functions of the **User Setup** menu.



Figure 3-2. 882IS/882IS Plus Menu Layout

Menu	Description
Audit	Audit Trail - Displays the (LRV) legally relevant firmware version, configuration count and calibration count (Section 3.2.1)
ID	Used to enter a User ID (Section 3.2.2)
Setup	Used to enter Configuration mode, if audit trail is enabled (Section 3.2.3 on page 31)
Test	System test functions (Section 3.3 on page 50)
Time & Date	Used to view or set time and date (Section 3.4 on page 50)
Accumulator	View, print or clear the current accumulator value, if enabled (Section 3.5 on page 51)
Tare	Views the current tare value (Section 3.6 on page 51)

Table 3-1. 882IS/882IS Plus Menu Summary

The following sections provide graphic representations of the 882IS/882IS Plus menu structures. In the actual menu structure, the settings under each parameter are arranged horizontally. To save page space, menu choices are shown in vertical columns. The factory default setting appears at the top of each column in **bold** letters. Parameters shown surrounded by a dotted-line box only appear under the special circumstances explained inside each box.

Most menu diagrams are accompanied by one or more tables that describe all parameters and parameter values associated with that menu.

3.2.1 Audit Menu

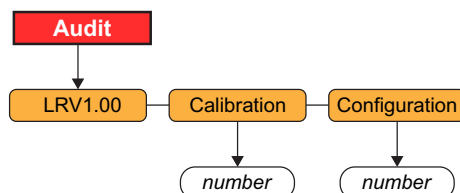

Figure 3-3. Audit Menu Structure

Menu	Description
LRV	Legally relevant firmware version (read only)
Calibration	Displays total calibration events (read only)
Configuration	Displays total configuration events (read only)

Table 3-2. Audit Menu Parameters

3.2.2 User ID

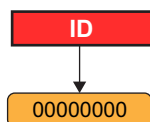

Figure 3-4. User ID Menu Structure

Menu	Description
ID	Enter User ID; The User ID is an alphanumeric string with a maximum of 16 characters NOTE: The User ID does not survive a power cycle and is used only for printing a token in a print format.

Table 3-3. User ID Menu Parameter

3.2.3 Setup Menu

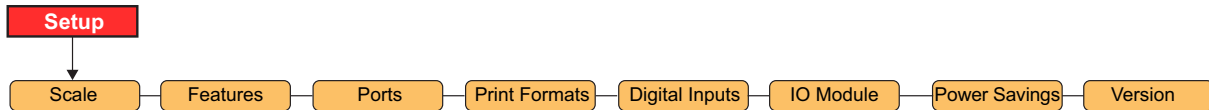

Figure 3-5. Setup Menu Structure

Menu	Description
Scale	Use the Scale menu to configure and calibrate the scale; See Figure 3-6 for the Scale menu structure
Features	Use the Features menu to set miscellaneous system attributes; See Figure 3-10 on page 36 for the Features menu structure
Ports	Use the Ports menu to configure communication ports; See Figure 3-14 on page 39 for the Ports menu structure
Print Format	Use the Print Format menu to set the print format used for header, gross, net and accumulator formats; See Figure 3-17 on page 42 for the Print Format menu structure
Digital Inputs	Use the Digital Inputs menu to assign digital input functions; See Figure 3-18 on page 43 for the Digital Inputs menu structure
IO Module	Use the IO Module menu to configure the IO module features (if installed); See Figure 3-23 on page 49 for the IO Module menu structure
Power Savings	Use the Power Savings menu to configure the power saving mode, wake threshold, backlight control and battery support
Version	Use the Version menu to display the installed firmware version number; See Section 3.2.19 on page 50 for the Version menu structure

Table 3-4. Setup Menu Parameters

3.2.4 Scale Menu

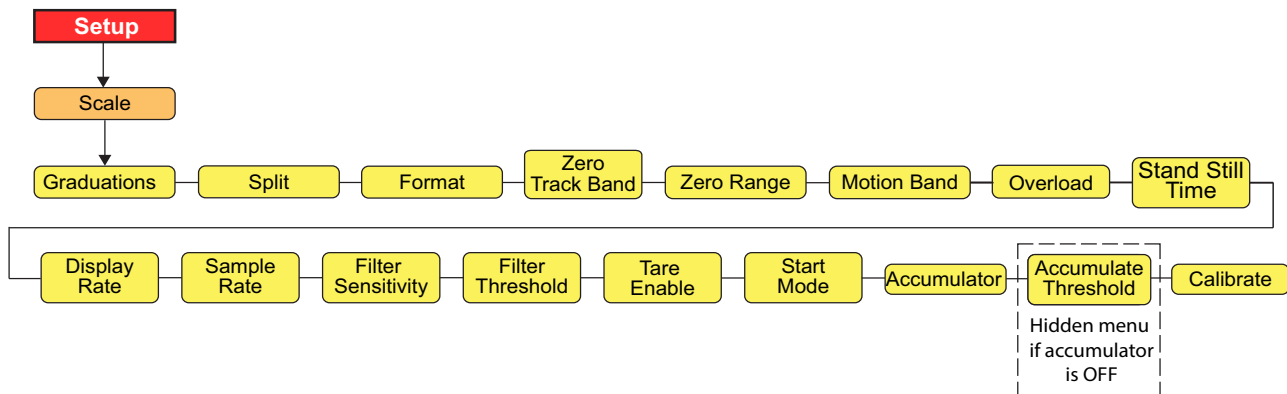

Figure 3-6. Scale Menu Structure

Menu	Choices	Description
Graduations	10000 1-100000	Graduations – Specifies the number of full scale graduations if Split=OFF; (for multi-range and multi-interval scales (SPLIT is not Off), Graduations value is derived from capacity and display divisions specified for range or interval); The value entered must be in the range 1–100000 and should be consistent with legal requirements and environmental limits on system resolution; To calculate Graduations, use the formula: $Graduations = Capacity / Display Divisions$; Display divisions are specified under the Format submenu
Split	OFF 2RNG 3RNG 2INTVL 3INTVL	Multi-range/Interval – Specifies whether the scale is full-range (OFF), multi-range (2RNG, 3RNG), or multi-interval (2INTVL, 3INTVL); For multi-range and multi-interval scales, see the submenu shown in Figure 3-8 on page 34 and parameter descriptions in Table 3-7 on page 34
Format	Primary Format	See Figure 3-8 on page 34 for menu structures; For standard scales see “If SPLIT = OFF”, for multi-range/interval scales see “If SPLIT = 2RNG, 3RNG, 2INTVL, or 3INTVL” or secondary format
Zero Track Band	0 0.0-100	Zero Track Band – Automatically zeros the scale when within the range specified, as long as the weight is within the Zero Range and scale is at standstill; Specify the zero tracking band in ± display divisions; The maximum legal value varies depending on local regulations
Zero Range	1.900000 0.0-100	Zero Range – selects the range within which the scale can be zeroed; The 1.900000 default value is ±1.9% around the calibrated zero point, for a total range of 3.8%. Indicator must be at standstill to zero the scale; Maximum legal value varies depending on local regulations

Table 3-5. Scale Menu Parameters

Menu	Choices	Description
Motion Band	1 0-100	Motion Band – Sets the level, in display divisions, at which scale motion is detected; If motion is not detected for the time defined by the standstill parameter, the standstill symbol lights; Some operations, including print, tare, and zero, require the scale to be at standstill; Maximum legal value varies depending on local regulations; If this parameter is set to 0 the standstill annunciator is always lit; Operations normally requiring standstill (zero, tare, print) are performed regardless of scale motion; If 0 is selected, Zero Track Band must also be set to 0
Overload	FS+2% FS+1D FS+9D FS FS+Percentage	Overload – Determines the point at which the display blanks and an out-of-range error message displays; Maximum legal value varies depending on local regulations If FS+Percentage is selected, a sub-menu is enabled. At FS+Percentage, press the down arrow to access the Enter Percentage parameter; Press the down arrow at Enter Percentage to view the current value; Edit as needed; Values are 0.0 - 150.0
Standstill Time	10 1-65535	Standstill Time – Specifies the length of time the scale must be out of motion, in 0.1-second intervals, before the scale is considered to be at standstill
Display Rate	1 1-80	Display update rate – Specifies the display update rate, in the number of 100-millisecond intervals between updates
Sample Rate	60HZ 120HZ 7.5HZ 15HZ 30HZ	Sample rate – Selects measurement rate, in samples per second, of the analog-to-digital converter; Lower sample rate values provide greater signal noise immunity; A setting of 120 Hz may be too fast to provide the desired stability in some static weighing applications
Filter Sensitivity	LIGHT MEDIUM HEAVY	Digital filtering sensitivity – The amount of influence the current A/D cycle has on the running averaged value; The Light setting will respond quicker to an applied weight to immediately impact the displayed value; Medium and Heavy settings are for applications where weighing times are longer and expected weight changes are larger
Filter Threshold	0 0-99999	Digital filter cutout threshold – Controls the response of the filter and must be set above the noise disturbances in the system; Value is in grads If set to zero there is no filtering
Tare Enable	BOTH NOTARE PBTARE KEYED	Tare function – Enables or disables push-button and keyed tare; BOTH – Both push-button and keyed tares are enabled NOTARE – No tare allowed (Gross mode only) PBTARE – Push-button tares enabled KEYED – Keyed tare enabled
Start Mode	GO DELAY	Start mode; GO – The indicator goes into operation immediately after a brief power up display test; DELAY – The indicator performs a power up display test, then enters a 30-second warm up period; If no motion is detected during the warm up period, the indicator becomes operational when the warm up period ends; If motion is detected, the delay timer is reset and the warm up period repeated
Accumulator	OFF ON	Accumulator – Specifies if the scale accumulator is enabled or disabled; If enabled, accumulation occurs every time a print operation is performed, while the weight is above zero, as long as the weight returns to a value lower than the threshold between print operations
Accumulate Threshold	0 0-999999	Accumulator Reset Threshold - When the weight falls below the value set, the accumulator is rearmed
Calibrate	WZERO WVAL WSPAN WLIN REZERO LAST TEMP	Calibration – See Figure 3-9 on page 35 for descriptions, and see Section 4.0 on page 52 for calibration procedures

Table 3-5. Scale Menu Parameters (Continued)

3.2.5 Scale Format Menu - if Split = Off

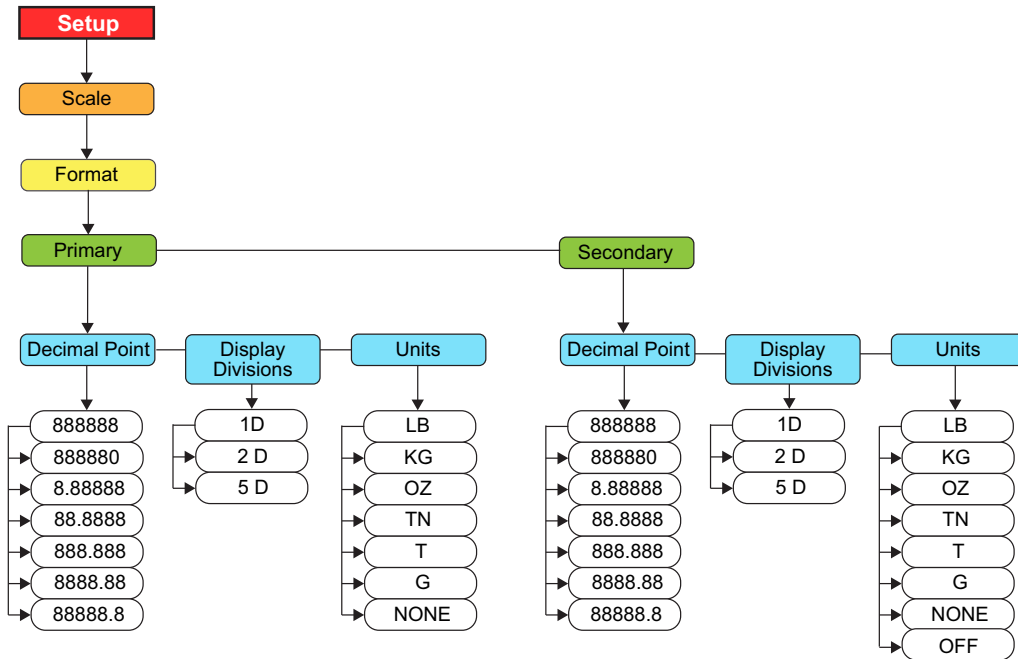

Figure 3-7. Format Menu Structure

Menu	Choices	Description
Primary	Decimal Point Display Divisions Units	Primary Units – Settings determine the scale capacity and specifies the decimal point, display division and units used
Secondary	Decimal Point Display Divisions Units	Secondary Units – Settings determine the Secondary, or Alternate, units value, decimal location, and display division size
Decimal Point	888888 888880 8.88888 88.8888 888.888 8888.88 88888.8	Decimal Point Location – when combined with the display divisions, specifies the location of the decimal point or dummy zeroed in the unit display Defaults: Primary – 888888 Secondary – 88888.8
Display Divisions	1D 2D 5D	Display Divisions – when combined with the decimal point location, specifies the minimum division size for the displayed weight Example: (88888.8 X 1D) X 5000 grads = 500 lb scale, counting by 1 Defaults: Primary – 1D Secondary – 5D
Units	LB KG OZ TN T G NONE OFF	Units – Specifies units for displayed and printed weight LB = pound – Primary default KG = kilogram – Secondary default OZ = ounces TN = short ton T = metric ton G = gram NONE = no units icon is shown on the display and no units text is included in print or stream output OFF = prevents the 882IS/882IS Plus from displaying secondary units

Table 3-6. Format Menu Parameters

3.2.6 Scale Format Menu - if split = 2 RNG, 3 RNG, 2 INTVL, 3 INTVL

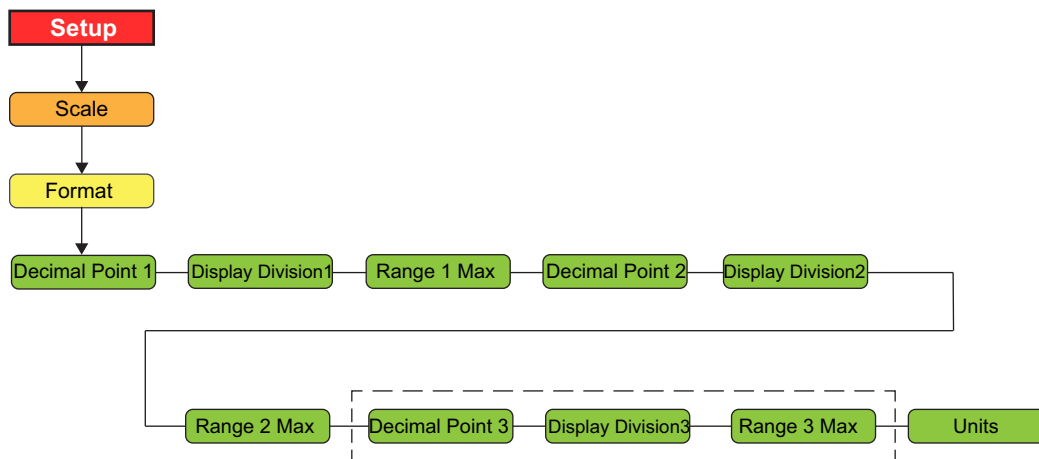

Figure 3-8. Split Format Menu Structure

Menu	Choices	Description
Decimal Point-1 Decimal Point-2 Decimal Point-3	888888 888880 8.88888 88.8888 888.888 8888.88 88888.8	Decimal Point Location – Specifies the location of the decimal point or dummy zeroed in the unit display Defaults: Decimal point 1 - 888888 Decimal point 2 - 88888.8 Decimal point 3 - 8888.88
Display Divisions 1 Display Divisions 2 Display Divisions 3	1D 2D 5D	Display Divisions – When combined with the decimal point location, specifies the minimum division size for the displayed weight Defaults: Display divisions 1 - 1D Display divisions 2 and display divisions 3 - 5D
Range 1 Max Range 2 Max Range 3 Max	Decimal	Range Max - specifies the upper weight limit of the given interval or range Defaults: Range 1 max - 2000.0 Range 2 max - 5000.0 Range 3 max - 10000.0
Units	LB KG OZ TN T G NONE	Units – Specifies units for displayed and printed weight LB = pound KG = kilogram OZ = ounces TN = short ton T = metric ton G = gram NONE = no unit icon is shown on the display and no units text is included in print or stream format

Table 3-7. Split Format Menu Parameters

3.2.7 Calibration Menu

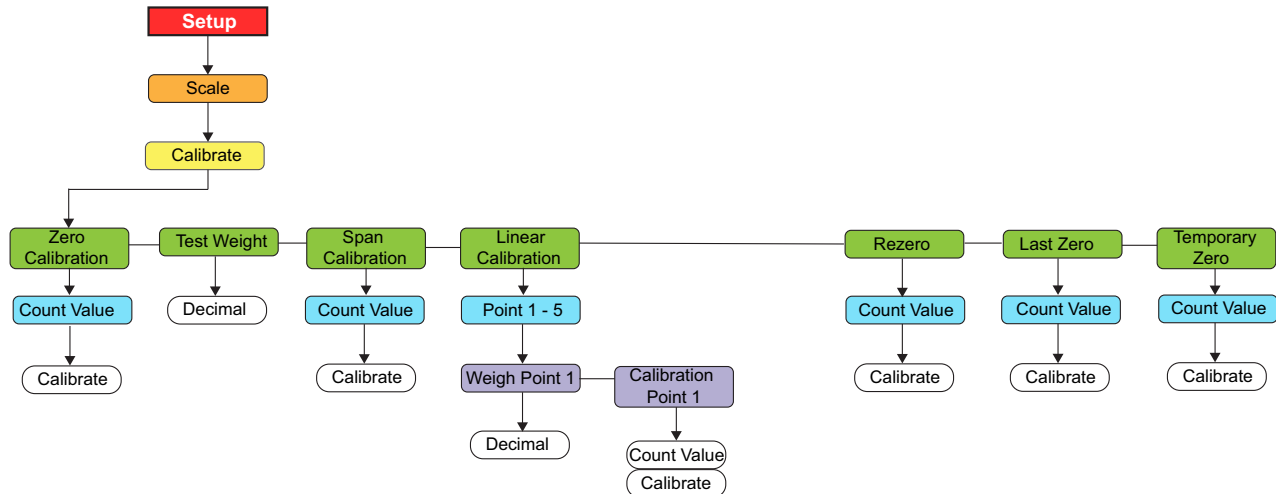

Figure 3-9. Calibration Menu Structure

Menu	Choices	Description
Zero Calibration	—	Press Enter to display previous A/D raw counts; Press Enter again to perform a zero calibration, press Menu to cancel
Test Weight	0.00001 — 9999999.0	Press Enter to display and edit the test weight value
Span Calibration	—	Press Enter to display previous A/D raw counts; Press Enter again to perform a span calibration, press Menu to cancel
Linear Calibration	Point-1 — Point-5	Press Enter to display and edit test weight and calibration values for up to five linearization points; Perform linear calibration only after Zero calibration and Span calibration have been performed
Rezero	—	Press Enter to remove an offset value from the zero and span calibrations Note: Use Rezero only after Zero Calibration and Span Calibration have been set. See Section 4.1 on page 53 for more information about using Rezero
Last	—	Press Enter to recall the last established push button zero to allow calibration without removing weight from scale (Section 4.2 on page 55)
Temporary Zero	—	Press Enter to temporarily zero the displayed weight from a loaded scale (Section 4.3 on page 55)

Table 3-8. Calibration Menu Parameters

3.2.8 Features Menu

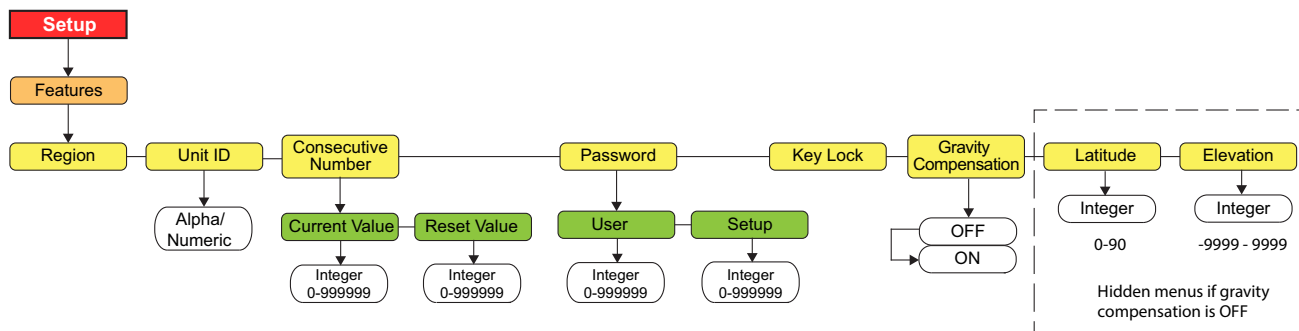

Figure 3-10. Features Menu

Menu	Choices	Description
Region	Regulation Regulation Word Decimal Format	Selects regional settings; See Level 3 sub menus (Figure 3-11 on page 37)
Unit ID	000000	Sets the unit ID, a string of up to 6 ASCII characters, which can be set via serial port or keypad; This will be used in place of the <UID> token in a print format; The default value is "1."
Consecutive Number	Current Value Reset Value	Allows sequential numbering for print operations; The consecutive number value is incremented following each print operation that includes <CN> in the ticket format; When the consecutive number is reset, it is reset to the Reset value specified in the parameter
Password	User Setup	Sets a password to access the Setup menu, or certain sub-menus in the User menu; Specify a non-zero value to enable the password; The setup password protects the entire Setup menu, and when set is required even when attempting entry into the Setup menu using the setup switch; The user password restricts access to the Time/Date and Accumulator sub-menus in the User menu; Passwords can be overridden by loading new firmware, or entering 999999 Note: Overriding passwords will clear configuration and calibration settings. To preserve settings (i.e., ID information), use Revolution software to upload the data to a PC, then download it back to the 882IS/882IS Plus after the password override is performed
Keylock	Zero Gross Net Units Print Tare Menu Numeric Keypad Function Key	Disables the listed keys; Select Lock to disable the key, and Unlock to enable the key
Gravity Compensation	Off On	Gravity compensation enable/disable
Latitude	45 0–90	Press Enter to display and edit the latitude in degrees for gravity adjustment to calibration (Gravity compensation must be set to On)
Elevation	345 -9999–9999	Press Enter to display and edit the elevation in meters for gravity adjustment to calibration (Gravity Compensation must be set to On)

Table 3-9. Features Menu Parameters

3.2.9 Region Menu

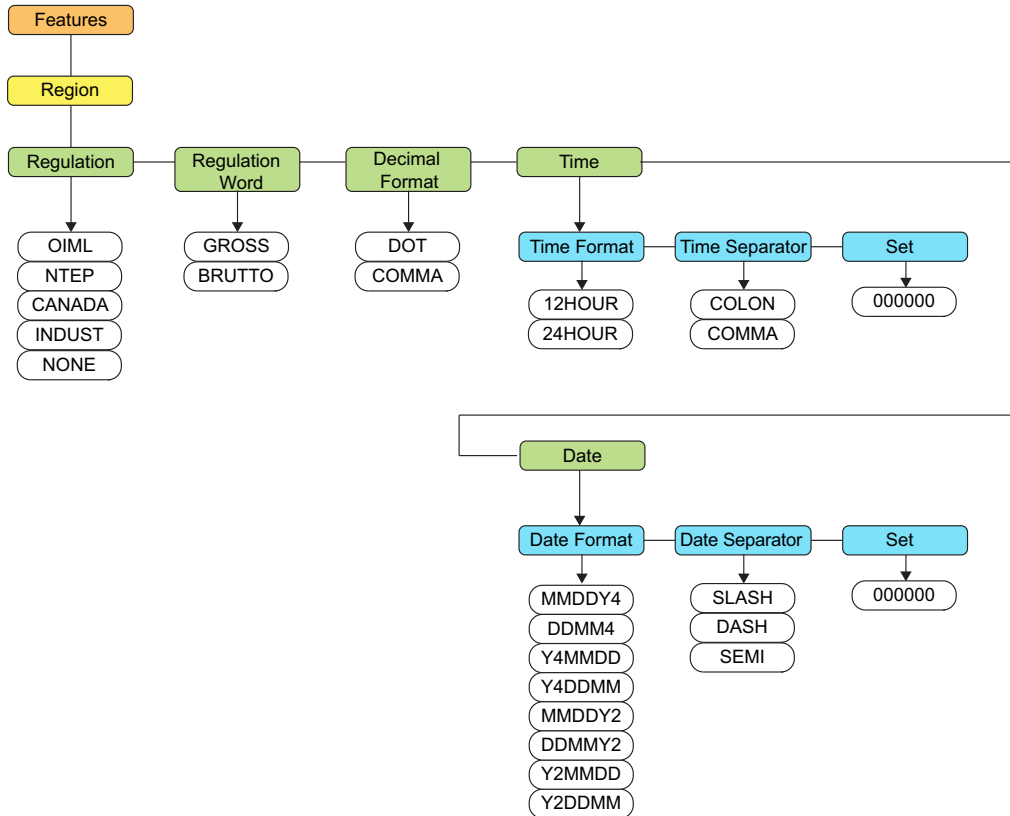

Figure 3-11. Region Menu Structure

Menu	Choices	Description
Regulation	OI ML NTEP Canada Industrial None	Regulatory mode – Specifies the regulatory agency having jurisdiction over the scale site; Note: Value specified for Regulation affects the function of the front panel Tare and Zero keys. <ul style="list-style-type: none"> OI ML, NTEP, and CANADA modes allow a tare to be acquired at any weight greater than zero; NONE allows tares to be acquired at any weight value OI ML, NTEP, and CANADA modes allow a tare to be cleared only if the gross weight is at no load; NONE allows tares to be cleared at any weight value NTEP and OI ML modes allow a new tare to be acquired even if a tare is already present; In CANADA mode, the previous tare must be cleared before a new tare can be acquired NONE, NTEP and CANADA modes allow the scale to be zeroed in either Gross or Net mode as long as the current weight is within the specified Zero Range; In OI ML mode, the scale must be in Gross mode before it can be zeroed; Pressing the Zero key in Net mode will zero the scale and clear the tare, if weight is within the specified Zero Range Selecting a particular Regulation will default the sub-parameters items to match; The user can then change the sub-parameters as they wish NOTE: Changing the sub-parameters may violate local regulations.
Regulation Word	Gross Brutto	Sets the term displayed when weighing in Gross mode; Selecting BRUTTO replaces the Gross annunciator with Brutto
Decimal Format	Dot Comma	Specifies whether decimal numbers are displayed using a period (DOT) or a comma
Time	Time Format Time Separator Set	Allows selection of time format and time separator character
Date	Date Format Date Separator Set	Allows selection of date format and date separator character

Table 3-10. Region Menu Parameters

3.2.10 Region - Regulation - Indust

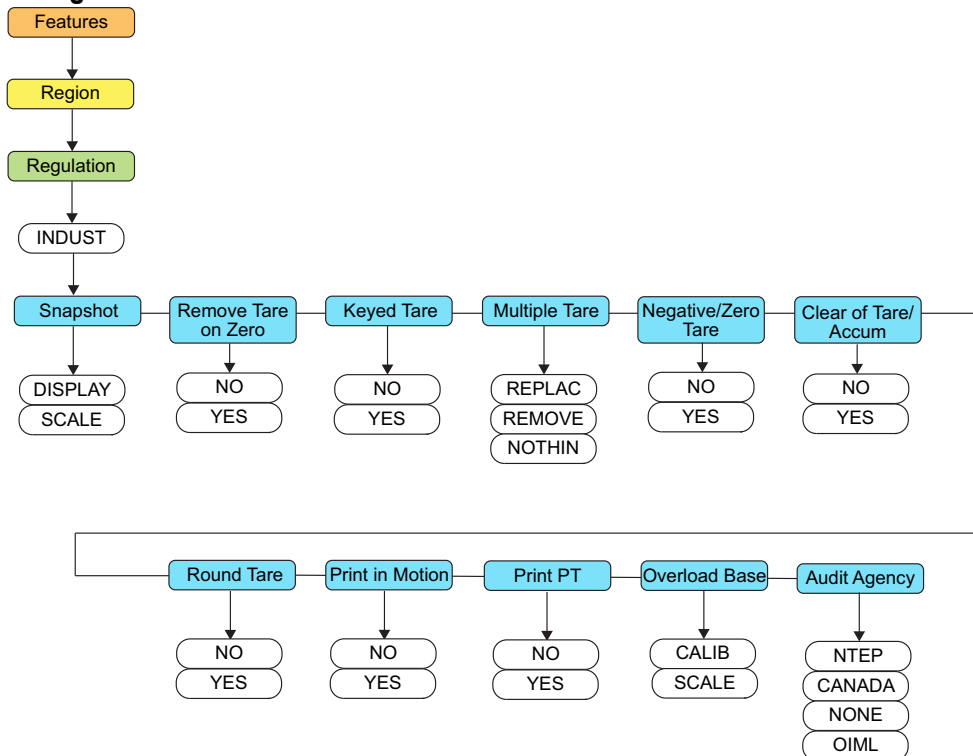

Figure 3-12. Region Regulation Menu Structure

Menu	Choices	Description
Snapshot	Display Scale	Display or scale weight source
Remove Zero Tare	No Yes	Remove tare on Z ero
Keyed Tare	Yes No	Always allow keyed tare
Multiple Tare	Replace Remove Nothing	Replaces existing Tare when the Tare key is pressed
Negative/Zero Tare	No Yes	Allow negative or zero tare
Clear of Tare/Accumulator	Yes No	Allow C lear key to clear tare/accumulator
Round Tare	Yes No	Round semi-automatic (pushbutton) tare to the nearest display division
Print in Motion	No Yes	Allow print while in motion
Print Preset Tare	No Yes	Add PT to keyed tare print
Overload Base	Calibrate Scale	Uses either the calibrated zero or the scale zero for overload calculation
Audit Agency	NTEP CANADA NONE OIML	Regulatory agencies

Table 3-11. Region Regulation Parameters

3.2.11 Keylock Menu

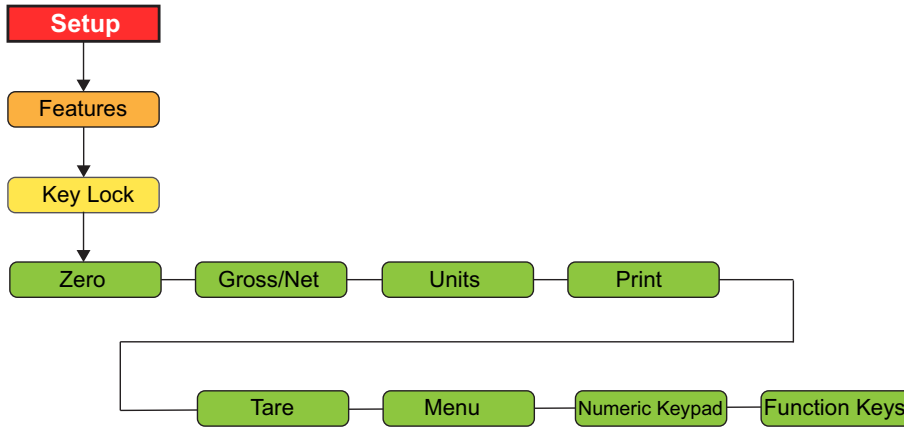

Figure 3-13. Keylock Menu Structure

Menu	Description
Zero	Lock or unlock individual keys; Settings: UNLOCK (default), LOCK NOTE: The Numeric Keypad parameter locks or unlocks all of the numeric keys. The numeric keys cannot be individually controlled. The Function Keys parameter locks or unlocks all of the function keys. The function keys cannot be individually controlled.
Gross/Net	
Units	
Print	
Tare	
Menu	
Numeric Keypad	
Function Keys	

Table 3-12. Keylock Menu Parameters

3.2.12 Setup Ports Menu

See [Section 3.2.13 on page 40](#) for **Serial Ports** menu choices and [Section 3.2.13 on page 40](#) for **Fiber Optic Ports** menu choices.

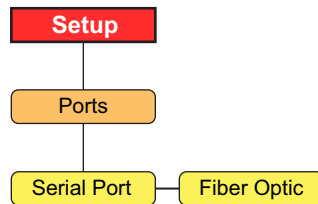

Figure 3-14. Ports Menu Structure

Menu	Description
Serial Port	See Section 3.2.13 on page 40 for Serial Ports menu choices
Fiber Optic	See Section 3.2.13 on page 40 for Fiber Optic Ports menu choices

Table 3-13. Ports Menu Summary

3.2.13 Ports - Serial Ports Menu

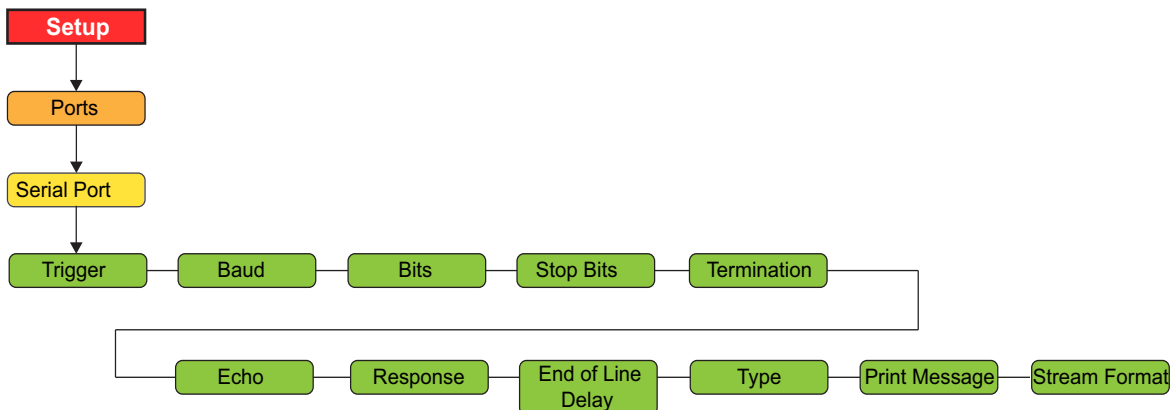

Figure 3-15. Serial Ports Menu Structure

Menu	Choices	Description
Trigger	Command	Setting Trigger to command allows operation of EDP commands and can print
	Stream Industrial	Stream Industrial scale data – Data is updated up to the configured sample rate; Allows operation of EDP commands and printing
	Stream Legal for Trade	Stream Legal for Trade – Data is updated at the configured display update rate; Allows operation of EDP commands and printing
	Remote*	Configures the serial port to operate as a serial scale input; When Trigger is set to REMOTE, the stream format is re-purposed to be the format for the incoming data
Baud	9600 19200 28800 38400 57600 115200 1200 2400 4800	Port baud rate
Bits	8None 7Even 7Odd	Port data bits and parity
Stop Bits	1 2	Stop Bits – Selects the number of stop bits transmitted and the number of stop bits expected to be received by the port
Termination	CR/LF CR	Termination – Selects the termination character(s) for data sent from the port carriage return (CR) line feed (LF)
Echo	On Off	Specifies whether characters received by the port are echoed back to the sending unit
Response	On Off	Response – Specifies whether the port transmits replies to serial commands
End of Line Delay	0 0-255	End of Line Delay - Specifies, in 0.1 second intervals, the delay between transmitted lines of data
Print Message	Off On	Print message – Displays a message when a print is transmitted on this port
Stream Format	<2><P><W7.> <U><M><S> <CR><LF>	Stream format – Specifies the stream format used for streaming output of scale data; When Trigger is set to REMOTE, the stream format is re-purposed to be the format for the incoming data

*When receiving scale stream through I/O module, remove <LF> from stream format on both streaming instrument and receiving instrument.

Table 3-14. Fiber Optics Menu Parameters

3.2.14 Ports - Fiber Optics Menu

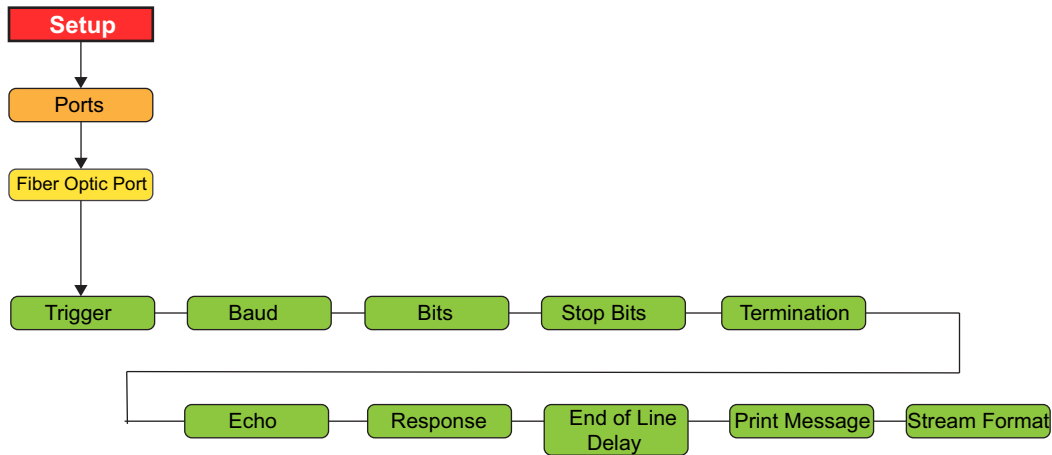

Figure 3-16. Fiber Optics Menu Structure

Menu	Choices	Description
Trigger	Command	Setting Trigger to command allows operation of EDP commands and can print
	Stream Industrial	Stream Industrial scale – Data is updated up to the configured sample rate; Allows operation of EDP commands and printing
	Stream Legal for Trade	Stream Legal for Trade – Data is updated at the configured display update rate; Allows operation of EDP commands and printing
	Remote	Configures the fiber optic port to operate as a serial scale input; When Trigger is set to REMOTE, the stream format is re-purposed to be the format for the incoming data
	IO Module	Enables port to communicate with the IO Module
	Setpoints	Enables setpoints to function with the 920i indicator
Baud	9600 19200 28800 38400 57600 115200 1200 2400 4800	Port baud rate
Bits	8None 7Even 7Odd	Port data bits and parity
Stop Bits	1 2	Stop Bits – Selects the number of stop bits transmitted and the number of stop bits expected to be received by the port
Termination	CR/LF CR	Termination – Selects the termination character(s) for data sent from the port
Echo	On Off	Specifies whether characters received by the port are echoed back to the sending unit
Response	On Off	Response – Specifies whether the port transmits replies to serial commands
End of Line Delay	0 0-255	End of Line Delay - Specifies, in 0.1 second intervals, the delay between transmitted lines of data
Print Message	Off On	Print message – Displays a message when a print is transmitted on this port
Stream Format	<2><P><W7.> <U><M><S> <CR><LF>	Stream format – Specifies the stream format used for streaming output of scale data; When Trigger is set to REMOTE, the stream format is re-purposed to be the format for the incoming data

Table 3-15. Fiber Optics Menu Parameters

3.2.15 Print Format Menu

See Section 7.3 on page 69 for information about custom print formatting.

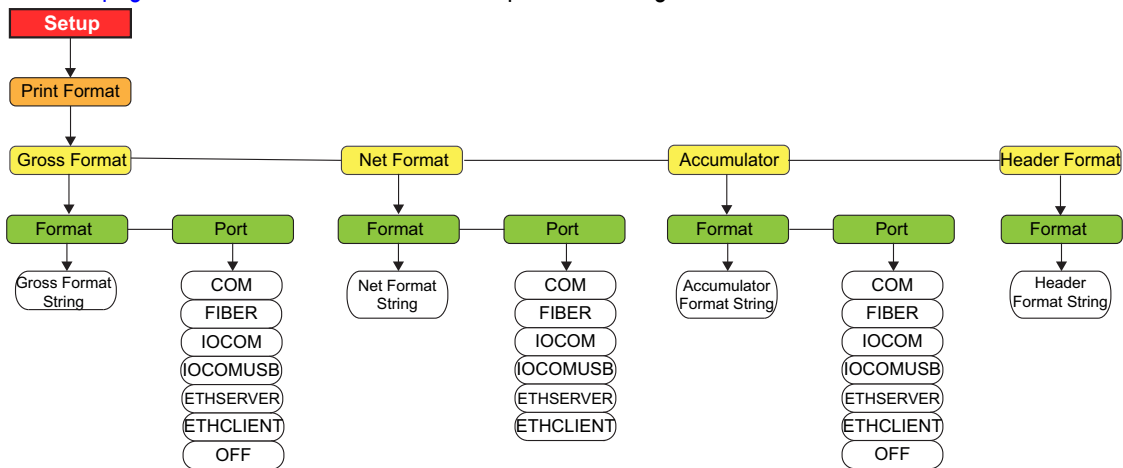

Figure 3-17. Print Format Menu Structure

Menu	Choices	Description
Gross Format	Format	Alphanumeric, Max Length: 1000; Weigh mode, no tare in system, GROSS<G><NL2><TD><NL>
	Port	The communications port the print data will be sent to: COM, FIBER, IOCOM, IOCOMUSB, ETHSERVER, ETHCLIENT, OFF
Net Format	Format	Alphanumeric, Max Length: 1000; Weigh mode, tare in system, GROSS<G><NL>TARE<SP><T><NL>NET<SP2><N><NL2><TD><NL>
	Port	The communications port the print data will be sent to: COM, FIBER, IOCOM, IOCOMUSB, ETHSERVER, ETHCLIENT, OFF
Accumulator	Format	Alphanumeric, Max Length: 1000; Accumulator enabled and displayed, ACCUM<A><NL><DA><TI><NL>
	Port	The communications port the print data will be sent to: COM, FIBER, IOCOM, IOCOMUSB, ETHSERVER, ETHCLIENT, OFF
Header Format	Format	Alphanumeric, Max Length: 300 Must be inserted into other print format; COMPANY NAME<NL>STREET ADDRESS<NL>CITY, ST ZIP<NL2>

Table 3-16. Print Format Menu Parameters

3.2.16 Digital Inputs Menu

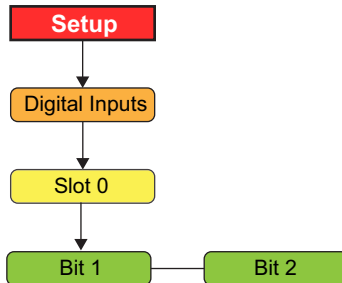

Figure 3-18. Digital Inputs Menu Structure

Menu	Choices	Description
Level 2 submenu		
Slot 0	Bit 1 Bit 2	Select the bit to set the function
Slot 0 submenu		
Bit 1 Bit 2	Off Print Zero Tare Units Clear DSPTAR DSPACC NT/GRS CLRCN KBDLOC GROSS NET PRIM SEC CLRTAR CLRACC	Specifies the function activated by Bits 1–2; <ul style="list-style-type: none"> • PRINT, ZERO, TARE, UNITS, NT/GRS provide the same functions as the five front panel keys • DSPTAR displays the tare • DSPACC displays the current accumulator value • CLRCN resets the consecutive number to the value specified on the Reset value parameter (Features menu) • KBDLOC locks the keyboard • GROSS, NET, PRIM and SEC select gross or net weight display, and primary or secondary units display modes • CLRTAR clears the current tare • CLRACC clears the accumulator

Table 3-17. Digital Input Menu Parameters

3.2.17 IO Module Menu

IO Module - Ports Menu

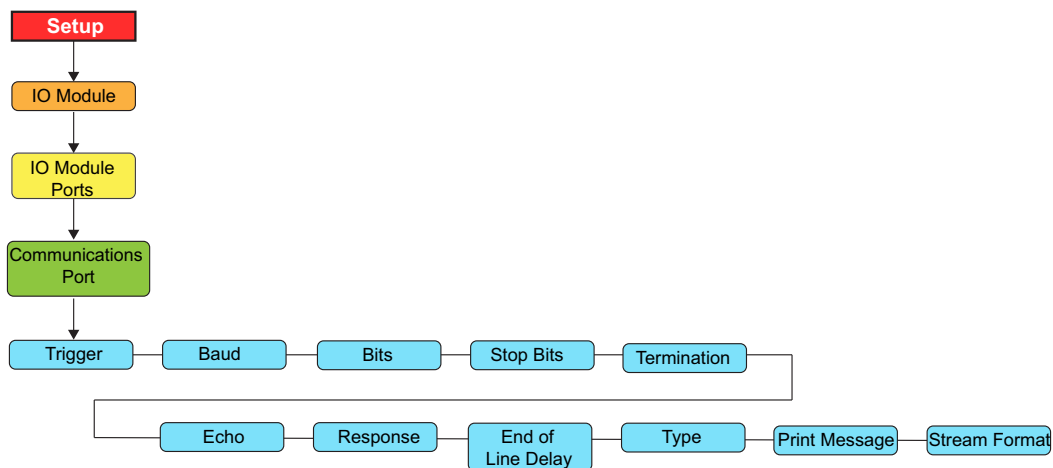

Figure 3-19. IO Module Ports Menu Structure

Menu	Choices	Description
Trigger	Command	Setting Trigger to command allows operation of EDP commands and can print;
	Stream Industrial	Stream Industrial scale – Data is updated up to the configured sample rate; Allows operation of EDP commands and printing
	Stream Legal for Trade	Stream Legal for Trade – Data is updated at the configured display update rate; Allows operation of EDP commands and printing
	Remote	Configures the IO module port to operate as a serial scale input; When Trigger is set to REMOTE, the stream format is re-purposed to be the format for the incoming data
Baud	9600 19200 28800 38400 57600 115200	Port baud rate
Bits	8None 7Even 7Odd	Port data bits and parity
Stop Bits	1 2	Stop Bits – Selects the number of stop bits transmitted and the number of stop bits expected to be received by the port
Termination	CR/LF CR	Termination – Selects the termination character(s) for data sent from the port
Echo	On Off	Specifies whether characters received by the port are echoed back to the sending unit
Response	On Off	Response – Specifies whether the port transmits replies to serial commands
End of Line Delay	0 0-255	End of Line Delay – Specifies, in 0.1 second intervals, the delay between transmitted lines of data
Type	232 422	Specifies the physical type of serial
Print Message	Off On	Print message – Displays a message when a print is transmitted on this port
Stream Format	<2><P><W7.> <U><M><S> <CR><LF>	Stream format – Specifies the stream format used for streaming output of scale data; When Trigger is set to REMOTE, the stream format is re-purposed to be the format for the incoming data

Table 3-18. IO Module Ports Menu Parameters

IO Module - USB

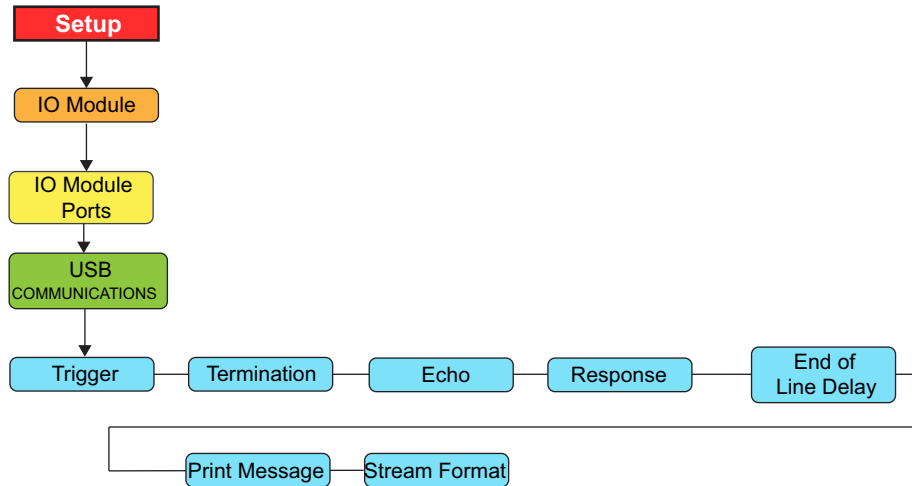

Figure 3-20. IO Module USB Menu Structure

Menu	Choices	Description
Trigger	Command	Setting Trigger to command allows operation of EDP commands and can print
	Stream Industrial	Stream Industrial scale – Data is updated up to the configured sample rate; Allows operation of EDP commands and printing
	Stream Legal for Trade	Stream Legal for Trade – Data is updated at the configured display update rate; Allows operation of EDP commands and printing
	Remote	Configures the IO module USB port to operate as a serial scale input; When Trigger is set to REMOTE, the stream format is re-purposed to be the format for the incoming data
Termination	CR/LF CR	Termination – Selects the termination character(s) for data sent from the port
Echo	On Off	Specifies whether characters received by the port are echoed back to the sending unit
Response	On Off	Response – Specifies whether the port transmits replies to serial commands
End of Line Delay	0 0-255	End of Line Delay – Specifies, in 0.1 second intervals, the delay between transmitted lines of data
Print Message	Off On	Print message – Displays a message when a print is transmitted on this port
Stream Format	<2><P><W7.> <U><M><S> <CR><LF>	Stream format – Specifies the stream format used for streaming output of scale data; When Trigger is set to REMOTE, the stream format is re-purposed to be the format for the incoming data

Table 3-19. IO Module USB Menu Parameters

IO Module - Ethernet

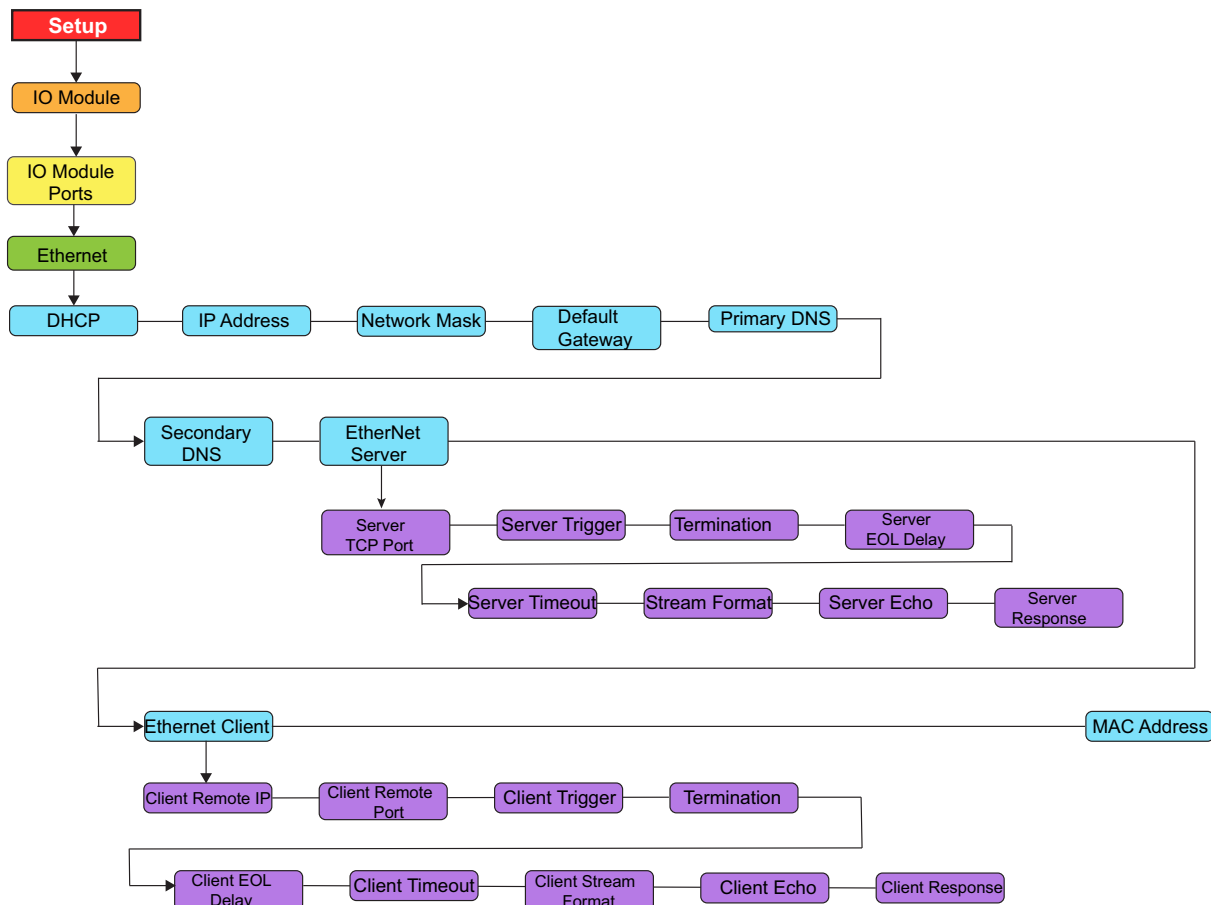

Figure 3-21. IO Module Ethernet Menu Structure

Menu	Description
DHCP	Dynamic Host Configuration Protocol; Settings: <i>ON (default), OFF</i> ; If DHCP is <i>ON</i> , the five parameters below are configured and set automatically by the network's DHCP server; If DHCP is <i>OFF</i> , the five parameters below must be manually configured as needed
IP Address	IP address (000.000.000.000)
Netmask	Netmask (000.000.000.000)
Default Gateway	IP address for the Default Gateway; (000.000.000.000)
Primary DNS	IP address for the primary DNS server; (000.000.000.000)
Secondary DNS	IP address for the secondary DNS server; (000.000.000.000)
Ethernet Server	See sub-menu parameters below
Ethernet Client	See sub-menu parameters below
Mac Address	The MAC address for this device; (Read Only)
Server/Client Sub-menu	
Client Remote IP Address	Client only: The IP address of the remote server of the IO module is connecting to (000.000.000.000)
Server TCP Port	The port on the 882IS/882IS Plus IO module for a remote client to connect to
Server Trigger	Select the operation of the port; Settings: <i>COMMAND (default)</i> – allows operation of EDP commands and will print <i>STRIND</i> – stream industrial scale – data is transmitted up to the configured A/D sample rate; Will also accept EDP commands and printing <i>STRLFT</i> – stream legal for trade scale data is transmitted at the configured display update rate; Will also accept EDP commands and printing
Termination	Selects the termination characters for data sent from the port

Table 3-20. IO Module Ethernet Menu Parameters

Menu	Description
Server EOL Delay	Specifies, in 0.1 second intervals, the delay between transmitted lines of data
Server Timeout	The connection is closed if there is no activity before the set time - 0 disables the inactivity disconnect; Enter value: 0-65535 seconds, 0 (default)
Stream Format	Specifies the stream format used for streaming output of scale data (Trigger=Stream Legal for Trade or Stream industrial) or specifies the expected input for a serial scale (Trigger=REMOTE)
Server Echo	Specifies whether characters received by the port are echoed back to the sending unit; Settings: OFF (default) , ON
Server Response	Specifies whether the port transmits replies to serial commands; Settings: ON (default) , OFF NOTE: If an external device (such as a printer), that may transmit unexpected data (such as a paper low message), is connected to the 882IS/882IS Plus the response parameter should be set to OFF to prevent a reply from the 882IS/882IS Plus from confusing the external device.
Client Remote Port	Client only: the TCP port number of the remote server of the IO module is connecting to; Enter value: 1-65535, 1 (default)
Client Trigger	Select the operation of the port; Settings: COMMAND (default) – Allows operation of EDP commands and will print STRIND – Stream industrial scale – Data is transmitted up to the configured A/D sample rate; Will also accept EDP commands and printing STRLFT – Stream legal for trade scale data is transmitted at the configured display update rate; Will also accept EDP commands and printing
Termination	Selects the termination character(s) for data sent from the port; Settings: CR/LF (default), CR
Client End of Line Delay	Specifies the delay between transmitted lines of data, in 0.1 second intervals; Enter value: 0-255, 0 (default)
Client Timeout	Connection is closed if there is no activity before the set time; 0 disables the inactivity disconnect; Enter value: 0-65535 (seconds), 0 (default)
Client Stream Format	Specifies the client stream format used for streaming output of scale data (Trigger=Stream Legal for Trade or Stream industrial) or specifies the expected input for a serial scale (Trigger=REMOTE).
Client Echo	Specifies whether characters received by the port are echoed back to the sending unit; Settings: OFF (default), ON
Client Response	Specifies whether the port transmits replies to serial commands; Settings: ON (default), OFF NOTE: If an external device (such as a printer), that may transmit unexpected data (such as a paper low message), is connected to the 882IS/882IS Plus the response parameter should be set to OFF to prevent a reply from the 882IS/882IS Plus from confusing the external device.

Table 3-20. IO Module Ethernet Menu Parameters (Continued)

IO Module - Option Card

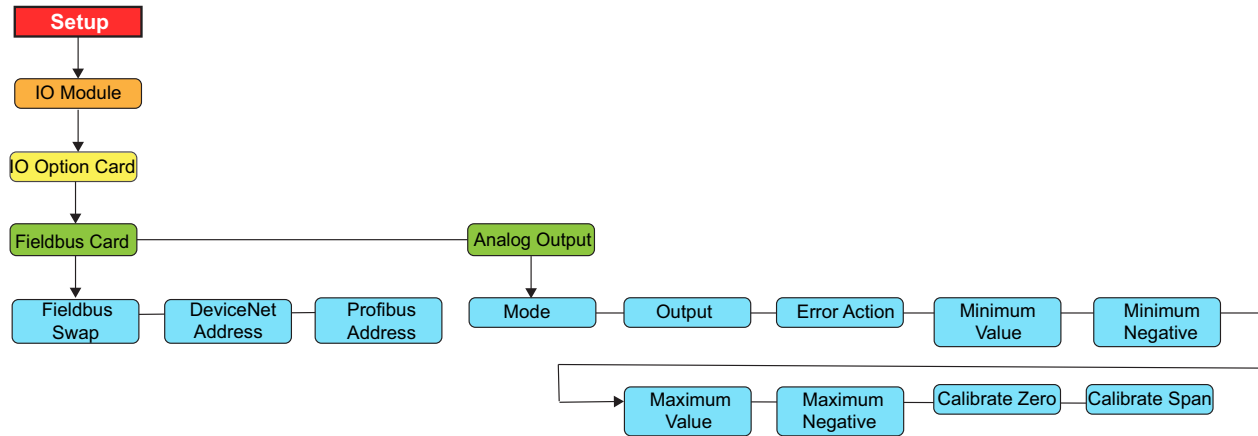

Figure 3-22. IO Module Option Card Menu Structure

Menu	Choice	Description
Fieldbus Card	Fieldbus Swap	Specifies byte-swapping used for the fieldbus card; Settings: NONE, BYTE, WORD, BOTH (Default for DeviceNet is BYTE ; Default for all other cards is NONE);
	DeviceNet Address	Is the address given to a DeviceNet option card; Range 1-64, 63 (default);
	Profibus Address	Is the address given to a Profibus option card; Range 1-126, 126 (default)
Analog Output	Mode	Mode – Specifies the weight data tracked by the analog output; Settings: GROSS (default), NET
	Output 1-10V 0-20mA 4-20mA	Selects whether the analog output supplies voltage (0-10 V - default), current (0-20mA) or current (4-20mA)
	Error Action	Error Action – Specifies how the analog output responds to system error conditions; Settings: <ul style="list-style-type: none"> FULLSC (default) – Set to full value (10 V or 20 mA) HOLD – Hold current value ZEROSC – Set to zero value (0 V or 4 mA)
	Minimum Value	Specifies the minimum weight value tracked by the analog output; Enter value: 0–9999999, 000000 (default)
	Minimum Negative	Specify ON if the minimum weight (MIN parameter) is a negative value; Settings: OFF (default), ON
	Maximum Value	Specifies the maximum weight value tracked by the analog output; Enter value: 0–9999999, 10000 (default)
	Maximum Negative	Specify ON if the maximum weight (MAX parameter) is a negative value; Settings: OFF (default), ON
	Calibrate Zero	Calibrate Zero – Edit the value to match the reading on the multimeter to perform a calibration
Calibrate Span	Calibrate Span – Edit the value to match the reading on the multimeter to perform a calibration	

Table 3-21. IO Module Analog Output Option Card Menu Parameters

3.2.18 Power Savings Menu

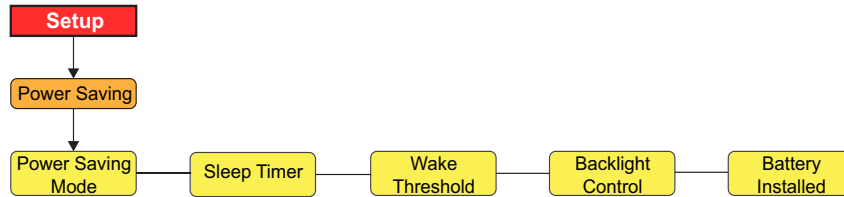

Figure 3-23. Power Savings Structure



NOTE: The conditions to enter Power Saving Mode vary depending upon the regulatory mode the unit is in (see [Table 3-22](#)). The configurable countdown time to enter Power Saving Mode is 30 seconds by default. The countdown timer starts once the conditions are met, but restarts if the conditions are no longer met (scale motion, key press, serial command received). Refer to [Section 3.2.9 on page 37](#) for additional details on the available regulatory modes.

Menu	Choices	Description
Level 2 submenu		
Power Saving Mode	Off Light Medium Aggressive	No power saving performed Turns off backlight Weight must be stable and the 882IS/882IS Plus must be in Weigh Mode Turns off backlight and blanks the display OIML, Industrial or None: Weight must be stable and the 882IS/882IS Plus must be in Weigh Mode; NTEP or Canada: Weight must be stable at gross zero and the 882IS/882IS Plus must be in Weigh Mode Turns off backlight, blanks the display and turns off the excitation OIML, NTEP or Canada: Weight must be stable at gross zero and the 882IS/882IS Plus must be in Weigh Mode; A weight change will not wake the indicator; Only a key press or receipt of serial data will wake the indicator from Aggressive; Industrial or None: Weight must be stable and the 882IS/882IS Plus must be in Weigh Mode
Sleep Timer	15 - 99999	Countdown time, in seconds, to enter Power Saving mode; Default value is 30 seconds
Wake Threshold	0.1 - 9999999.0	Once asleep, if the primary weight goes above the value, the indicator wakes; The wake threshold does not apply for the Aggressive Power Saving Mode when configured for OIML, NTEP or CANADA regulatory mode; In that case, only a key press or serial command will wake the unit
Backlight Control	On Off	Manually controls whether the backlight is on or off
Battery Installed	No Yes	Manually controls whether the indicator is being powered by a battery Power saving functionality is only activated if the battery installed is set to yes

Table 3-22. Power Savings Menu Parameters

3.2.19 Version Menu

Version menu is used to check the firmware version installed in the indicator and set the indicator configuration to factory defaults.

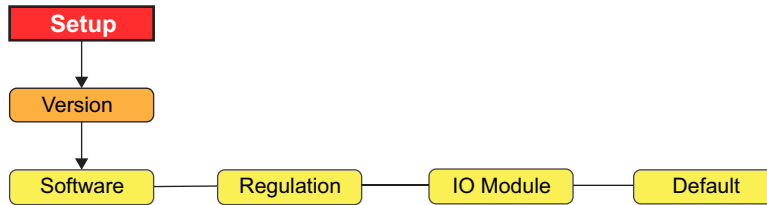

Figure 3-24. Version Menu Structure

Menu	Choices	Description
Software	VX.XX.XX	Displays firmware version number
Regulation	LVR X.XX	Displays the Legally Relevant firmware version number
IO Module	None IO Version	Signifies that it does not see the IO Module' Signifies that the indicator see the IO Module and responds with the firmware version of the IO Module
Default	No Yes	Performs a reset of all the indicator parameters to factory default settings IMPORTANT – All configuration and load cell calibration data will be lost

Table 3-23. Version Menu Parameters

3.3 Test Menu

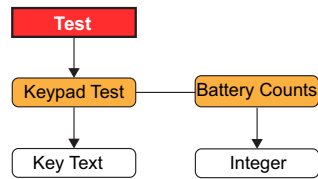

Figure 3-25. Test Menu Structure

Menu	Choices	Description
Keypad Test	--	Allows the 882IS/882IS Plus keypad to be tested; Key presses are displayed and also transmitted on the COM port
Battery Counts	35064 (5.8V = 3/4 charge after barrier)	View the current battery voltage as counts; The value shown at left is approximate; Expect the voltage to drop as it passes through the protection barrier; Count value is an estimate of the battery voltage as measured at J3 (after the protection barrier) and is therefore not equal to the true battery voltage as measured at the battery terminals (inside the sealed battery box)

Table 3-24. Test Menu Parameters

3.4 Time and Date

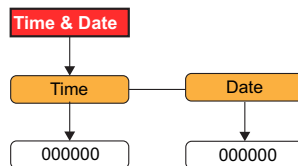

Figure 3-26. Time and Date Menu Structure

Menu	Choices	Description
Time	-	View or set the time
Date	-	View or set the date

Table 3-25. Time and Date Menu Parameters



NOTE: Time and date are only retained when using the I/O Module option.

3.5 Accumulator Menu

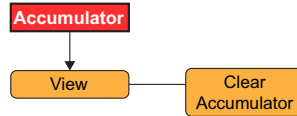

Figure 3-27. Accumulator Menu Structure

Menu	Choice	Description
View	-	Views the current accumulator value, if enabled
Clear Accumulator	-	Clears the current accumulator value, if enabled

Table 3-26. Accumulator Menu Parameters

3.6 Tare

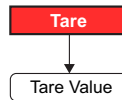

Figure 3-28. Tare Menu Structure

Menu	Choice	Description
Tare	-	Views the current tare value

Table 3-27. Tare Menu Parameter

4.0 Calibration

The 882IS/882IS Plus can be calibrated using the front panel, EDP commands, or Revolution configuration utility.

Calibration consists of the following steps:

- Zero calibration
- Entering the test weight value
- Span calibration
- Optional five-point linearization
- Optional rezero calibration for test weights using hooks or chains
- Optional last zero calibration
- Optional temporary zero calibration



NOTE: The 882IS/882IS Plus requires the Zero Calibration and Span Calibration to be calibrated. The linearity points are optional; they must fall between zero and span, but must not duplicate zero or span. During calibration, Tare acts as a data entry confirmation key. Tare acts as an Enter key, and accepts the value if calibration was successful.

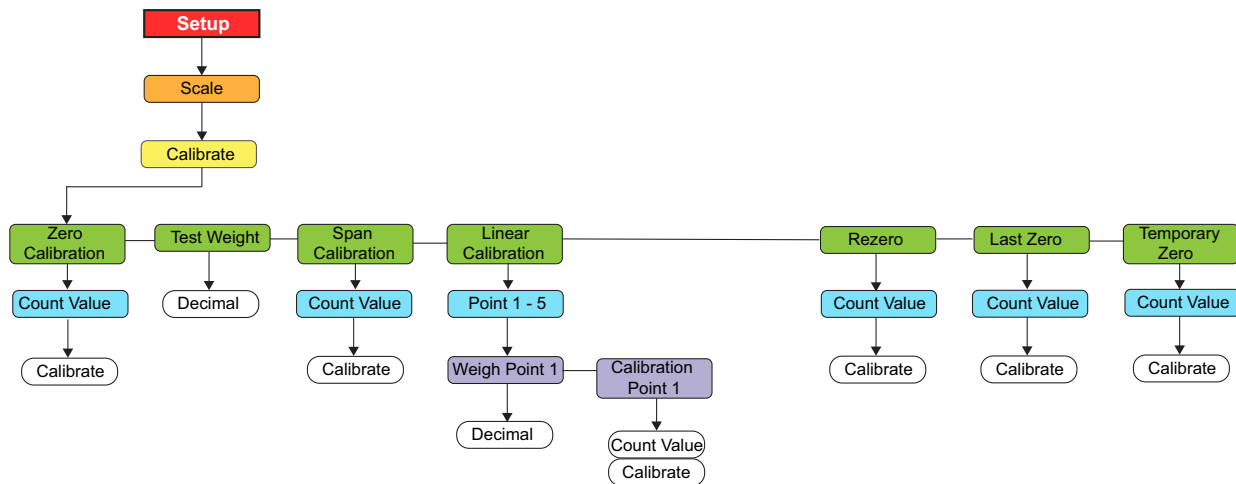









Figure 4-1. Calibration Menu

4.1 Front Panel Calibration

- Put the indicator in setup mode (Figure 3-1 on page 29) (or use  if audit trail is enabled), and navigate to **Calibrate** (Figure 4-1 on page 52).



- Press  or  to go to the **Zero Calibration** parameter.

 **NOTE: Zero Calibration is used for most normal calibrations with an empty scale. If a special situation exists, where a Last Zero or Temporary Zero are used, refer to Section 4.2 on page 55 or Section 4.3 on page 55 for more information before performing a Zero Calibration.**







- Press  or  to view the previously captured A/D count value for zero.
- Remove all weight from the scale. If the test weights require hooks or chains, place the hooks or chains on the scale for zero calibration.
- Press  to perform zero calibration.

 **NOTE: Press  to leave without performing a calibration.**

- The indicator displays **Calibrating, Please Wait** while calibration is in progress. When complete, **Test Weight** displays.

 **NOTE: To view the new zero A/D count, press  then repeat Step 3, but instead of pressing Enter while viewing the value, press  to exit.**

- With **Test Weight** displayed, press  to display the stored calibration weight value.
- Edit the value using the keypad on the 882IS Plus or the numeric entry method for the 882IS/882IS Plus.



- Press  or  to select the digit
- Press  or  to increment or decrement the value
- Press  when the value is correct
- Press  or  to move the decimal point position

- Press  to store the **Test Weight** value and advance to **Span Calibration**.



- With **Span Calibration** displayed, press  or  to view the previously captured A/D count value for span.

- Place calibration weights on the scale equal to test weight value.

- Press  to perform span calibration.

 **NOTE: If calibration of span is not required, press  to exit.**

- Press  the indicator displays **Calibrating, Please Wait** while calibration is in progress. When complete, **Linear Calibration** displays.

 **NOTE: To view the new span A/D count, press  then repeat Step 9, but instead of pressing Enter while viewing the value, press  to exit.**











- Press  when calibration is complete, to return to **Weigh** mode.

4.1.1 Five-Point Linearization

Five-point linearization (using the Linear Calibration parameter) provides increased scale accuracy by calibrating the indicator at up to five additional points between the zero and span calibrations. Linearization is optional: if choosing not to perform linearization, skip the **Linear Calibration** parameter; if linearization values have previously been entered, these values are reset to zero during zero calibration. To perform linearization, follow the procedure below.







NOTE: *Linear Calibration points must be less than the Span Calibration point.*

1. With **Linear Calibration** displayed, press , **Point-1** displays.
2. Press  again, **Weigh Point 1** displays.
3. Press  to display the value of the weigh point.
4. Edit the value using the keypad on the 882IS Plus or the or the numeric entry method for the 882IS.
5. Press  to confirm value. The indicator displays **Calibration Point 1**.
6. Place test weights on the scale and press . The indicator displays the previously captured A/D counts for the linearization point.
7. Press  again to calibrate. The indicator displays **Calibrating, Please Wait** while calibration is in progress. When complete, **Weight Point 1** displays.
8. Press  to **Point-1**, then press  to **Point-2**.
9. Repeat for up to five linearization points. To exit the linearization parameters, press  to return to **Linear Calibration**.
10. Press  when calibration is complete, to return to the **Weigh** mode.

4.1.2 Rezero

Rezero function is used to remove a calibration offset when hooks or chains are used to hang the test weights.

1. With **Rezero** displayed, press  or  to access the rezero function.
2. Remove all weight from the scale, including all hooks and chains. The indicator displays the AD count from the previous zero calibration.
3. With all weight removed, press  to rezero the scale. This function acquires a new ZERO calibration value. The indicator displays **Calibrating, Please Wait** while the zero and span calibrations are adjusted. When complete, **Last Zero** displays.
4. Press  to return to **Weigh** mode.

4.2 Last Zero

Last zero (typically platform scales) replaces the original captured zero with the last push button zero prior to a calibration and does not need to remove the test weights.



NOTE: To use this feature a pushbutton zero must have been taken while the scale was empty while in the **Weigh** mode.

Perform a normal calibration, except instead of using Zero Calibration to capture the zero point of an empty scale, select **Last Zero** to use the last pushbutton zero. The test weight does not need to be removed from the scale.

4.3 Temporary Zero

Temporary zero (typically tank scales) is only a reference for a span calibration, and allows the original zero to be retained after a span adjustment has been done.



NOTE: This procedure assumes the previously calibrated zero point is still accurate.

Perform a normal calibration, except instead of using **Zero Calibration** to capture the zero point of an empty scale, select **Temporary Zero**. After calibrating the temporary zero, enter **into Test Weight the value** of the test weights added to the scale (just the test weights, not the product loaded on the scale). Then perform the span calibration.

4.4 Adjusting Final Calibration (Trimming)

Calibration may be affected by environmental factors including wind, vibration, and angular loading. For example, if the scale is calibrated with 1000 lb, a strain test may determine that at 2000 lb the calibration is 3 lb high. In this case, final calibration can be adjusted by changing the test weight to 998.5 lb. This adjustment provides a linear correction of 1.5 lb per 1000 lb.

4.5 Gravity Compensation

This feature is used to compensate for the variance in gravitational pull from one location to another. To calibrate with gravity compensation, the Gravity Compensation parameter under the **Features** menu must be set to ON ([Section 3.2.8 on page 36](#)), and the Latitude and Elevation (elevation in meters, relative to sea level) parameters set before calibrating the indicator.

If the indicator is later installed at a different location, gravity compensation can be applied to a pre-calibrated indicator by adjusting the Latitude and Elevation parameters.

4.6 EDP Command Calibration

To calibrate the indicator using EDP commands an indicator or IO Module port must be connected to a terminal or personal computer. See [Section 2.5 on page 21](#) for cable connections.



NOTE: The indicator will respond with OK if the value of the parameter was valid, or the command executed properly. If the indicator responds with ??, then either the value for the parameter was invalid, or the command could not be executed.

Once the indicator is connected to the sending device, do the following:

- Place the indicator in setup mode and remove all weight from the scale platform. If the test weights require hooks or chains, place the hooks or chains on the scale for zero calibration.
- Send the SC.WZERO#1 command to calibrate zero. The indicator displays **Calibrating, Please Wait** while calibration is in progress.
- Place test weights on the scale and use the SC.WVAL#1 command to enter the test weight value in the following format:
SC.WVAL#1=nnnnnn<CR>
- Send the SC.WSPAN#1 command to calibrate span. The indicator displays **Calibrating, Please Wait** while calibration is in progress.
- Up to five linearization points can be calibrated between the zero and span calibration values. Use the following commands to set and calibrate a single linearization point:
SC.WLIN.V1#1=nnnnn<CR>
SC.WLIN.C1#1<CR>
The SC.WLIN.V1#1 command sets the test weight value (nnnnn) for linearization point 1. The SC.WLIN.C1#1 command calibrates the point. Repeat using the SC.WLIN.Vn#1 and SC.WLIN.Cn#1 (where 'n' is the linearity point number) commands as required for additional linearization points.
- To remove an offset value, clear all weight from the scale, including the hooks or chains used to hang test weights, then send the SC.REZERO#1 command. The indicator displays **Calibrating, Please Wait** while the zero and span calibrations are adjusted.
- Send the KMENU or KEXIT EDP command to return to **Weigh** mode.

4.7 Revolution® Calibration

To calibrate indicator using Revolution, an indicator port must be connected to a PC running the Revolution configuration utility.

1. Place the indicator in **Configuration** mode (display reads **Scale**) and remove all weight from the scale platform.
1. Select **New** from the File menu.
2. The *Select Indicator* dialog box appears. Select the 882IS/882IS Plus icon and click **OK**.
3. Select **Connect** from the Communications menu.
4. Select **Scale** from the left-side menu and then click the *Scale* icon.
5. Select **Calibration Wizard** from the Tools menu and the *Calibration Wizard* window appears.
6. Select Standard Calibration (zero and span) or Standard with Multi-Point Linearization and then click **Next** to continue.
7. Enter the test weight used to calibrate the scale. If chains or hooks are used to hold the weights, check the box below the test weight value entry. This adds a Rezero step to the calibration sequence.
8. Remove all weights from the scale. If chains or hooks are used, place them on the scale. Click the **Calibrate Zero** button to perform the zero calibration. A message box appears when the process is complete.
9. Apply the test weights to the scale. Click the **Calibrate Span** button to perform the span calibration. A message box appears when the process is complete.
10. If the option for chains or hooks was selected in Step 7, the Rezero step displays. remove all weights from the scale including chains or hooks. Click the **Re-Zero** button to calibrate the zero offset.
11. If performing a multi-point linear calibration, up to five other calibration weight values can be entered on the display. The weights must be in ascending order and must not include zero or the span weight. Enter the weight values and click the **Go** button to calibrate each point.
12. Review the new calibration values and then click **Finish** to close the Calibration Wizard or click **Cancel** to restore the previous calibration values.

5.0 Using Revolution

The Revolution utility provides functions used to support configuration, calibration, customizing and backup of the 882IS/882IS Plus configuration settings using a PC.

Calibration values, scale configuration and print ticket formatting can be configured, saved and restored to the 882IS/882IS Plus using Revolution.



NOTE: *Firmware updates for the 882IS/882IS Plus are done without using Revolution. Independent steps are noted in Section 10.11 on page 87.*

882IS/882IS Plus IO Module firmware can be updated using Revolution. The link to begin this process is available on the Revolution home screen. Updating the firmware defaults configuration settings. For more information on jumper position and steps on updating firmware, see the 882IS/882IS Plus I/O Module Installation Manual (PN 194139).



NOTE: *For system requirements visit the Rice Lake Weighing Systems website at www.ricelake.com.*

5.1 Communication With the Indicator

Communicating to the 882IS/882IS Plus can be accomplished in the following ways:

- Using a serial connection to the indicator serial (COM) port through J3
- Using a USB connection and Virtual Comm Port to the indicator's USB Micro Device (USBCOM) port through J4
- Using a TCP/IP connection through the Ethernet Port (J6)

After making the physical connection to a PC, select the Options in the Tools menu and configure the communications settings as needed to match the communications method that is being used:

- RS-422 – Select the COM port that it will be connected to; Settings can be configured manually to match the indicator's current settings, or check the box for “Auto Detect Settings” to have Revolution automatically detect the settings
- USB – Select RS-422 as the communication mode, the USB connection appears as a standard COM port to Revolution; The comm port for the USB connection will only show in the list of available ports if the indicator is physically connected, and powered on. The settings for baud rate, data and stop bits, and parity do not apply for a USB connection, and do not need to be set to any specific value.
- TCP/IP – Requires the IP address and TCP Port of the indicator. Enter the IP Address and Port during the communications connection.

To open the communication connection, click on Connect under the Communications menu, or the Connect button in the toolbar. Revolution will attempt to establish communications with the indicator.



NOTE: *If Revolution does not detect the indicator, check the:*

Physical connections

Communications settings in Revolution

Current settings of the communications port in the indicator

Indicator communications port Trigger parameter is set to Command

If Revolution displays a Version Error, the indicator version of firmware does not match the module used in Revolution. A connection can be forced, but some parameters may not be enabled if they were not originally supported in that module.

5.2 Configuration

The Revolution configuration utility provides the preferred method for configuring the 882IS/882IS Plus indicator. Revolution runs on a PC to set configuration parameters for the indicator. When Revolution configuration is complete, configuration data is downloaded to the indicator.

5.2.1 New Configuration File

1. Select **New File** on the toolbar (**NEW** under the file menu can also be used).

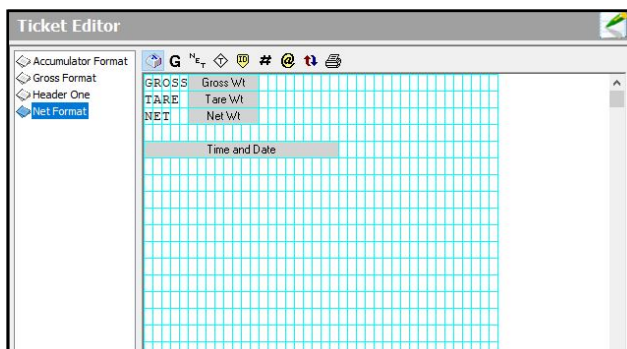

Figure 5-1. Revolution Main Screen

2. Select the icon for the indicator with the appropriate firmware version for which the configuration file is to be created.
3. Revolution will create a default configuration file. Edit the settings, upload the indicator's current settings, or download the default settings to the indicator.

5.2.2 Open an Existing Configuration File

1. Select **Open File** on the tool bar (**Open** under the file menu can also be used).
2. Navigate to the *.rev file to open then click the **OK** button.
3. Revolution opens the file, selecting the correct indicator module to use with it. Edit the settings, or download the settings to the indicator.

5.2.3 Saving a Configuration File

Select **Save File** on the tool bar (**Save** under the file menu can also be used).

- If the file is new, enter a name when requested.
- If the file already exists, confirm to overwrite the previous file.
- Select cancel to exit the save process without saving.
- Select Save As under the file menu if saving to a different file name.

Downloading to the Indicator

The **Send Configuration to Device** function in the Revolution Communications menu allows a Revolution configuration file (with or without scale calibration data) or ticket formats to be sent/downloaded to a connected indicator in *Setup* mode.

The **Send Section to Device** function in the Revolution Communications menu allows download of only the currently displayed section, such as the communications port configuration.

Because less data is transferred using **Send Section to Device**, it is typically faster than a full configuration download, but there is an increased possibility that the download may fail due to dependencies on other objects. If the download fails, try performing a complete download using the **Send Configuration to Device** function.

Uploading Configuration to Revolution

The **Get Configuration from Device** function in the Revolution Communications menu allows the existing configuration of a connected indicator to be saved to a file on the PC. Once saved, the configuration file provides a backup that can be quickly restored to the indicator if needed. Alternatively, the file can be edited within Revolution and sent back to the indicator.

5.3 Revolution Help

The menu bar in Revolution contains a Help system for further assistance in using Revolution software.

The Help system contains an index of help topics and a search function. The search function allows the user to search with a keyword. When a keyword is typed into the search text box, Help searches its Index and finds the closest related topic in the help system.

6.0 EDP Commands

The 882IS/882IS Plus indicator can be controlled by a personal computer or terminal using the EDP commands, which can simulate front panel key press functions, display and change setup parameters, and perform reporting functions.

6.1 The EDP Command Set

The EDP command set can be divided into seven groups: key press commands, reporting commands, the **RESETCONFIGURATION** special function command, parameter setting commands, **Weigh** mode commands, error conditions commands.

When the indicator processes an EDP command, it responds with the message **OK**. The **OK** response verifies that the command was received and has been executed. If the command is unrecognized or cannot be executed, the indicator responds with **??**.

The following sections list the commands and command syntax used for each of these groups.

6.1.1 Key Press Commands

Key press EDP commands (Table 6-1) simulate pressing the keys on the front panel of the indicator. These commands can be used in both setup and weighing mode. Several of the commands serve as “pseudo” keys, providing functions that are not represented by a key on the front panel.

For example, to enter a 15-pound tare weight using EDP commands:

1. Type K1 and press **Enter** (or **RETURN**).
2. Type K5 and press **Enter**.
3. Type KTARE and press **Enter**.

Command	Function
KMENU	Press the Menu key
KZERO	Press the Zero key
KUNITS	Press the Units key
KPRINT	Press the Print key
KTARE	Press the Tare key
KGROSSNET	Press the Gross/Net key
KGROSS	Go to Gross mode
KNET	Go to Net mode
KSDISPACCUM	Display ACCUM (pseudo key)
KDISPTARE	Display Tare (pseudo key)
KCLR	Press the Clear key (pseudo key)
KCLRTAR	Clear tare from system (pseudo key)
KLEFT	In Menu mode, move left in menu
KRIGHT	In Menu mode, move right in menu
KUP	In Menu mode, move up in the menu
KDOWN	In Menu mode, move down in the menu

Command	Function
KSAVE	In Menu mode, saves the current configuration (pseudo key)
KEXIT	In Menu mode, save the current configuration then exits to Weigh mode (pseudo key)
K0-K9	Press number 0 (zero) through 9
KDOT	Press the decimal point (.)
KENTER	Press the Enter key (pseudo key)
KLOCK	Lock specified front panel key, ie: to unlock the Print key, enter KUNLOCK=KPRINT (pseudo key)
KUNLOCK	Unlock specified front panel key, ie: to unlock the Print key, enter KUNLOCK=KPRINT (pseudo key)
KESCAPE	Exits selected parameter; Returns to Weigh mode if a parameter is not selected (functions identical to the Menu key in Menu mode) (pseudo key)
KPRIM	Change to primary units (pseudo key)
KSEC	Change to secondary units (pseudo key)

Table 6-1. EDP Key Press Commands

6.1.2 Reporting Commands

Reporting commands (Table 6-2) send specific information to the EDP port. These commands can be used in both **Configuration** mode and **Weigh** mode.

Command	Function
AUDITJUMPER	Returns the state of the audit jumper; A response of OK indicates the jumper is in the On position; A response of "??" indicates the jumper is in the Off position
BUILD	Returns the date and time of the software build
DUMPALL	Returns a list of all parameter values
DUMPAUDIT	Returns a list of audit trail information
DUMPETH	Returns a list of all parameter values pertaining to the Ethernet
VERSION	Returns the 8821S/8821S Plus firmware version
P	Returns the current displayed weight with units identifier
IOMODULEVERSION	Returns the IO module firmware version, if attached; If no IO module is attached/detected, NONE is returned

Table 6-2. EDP Reporting Commands

6.1.3 The RESETCONFIGURATION Command

The RESETCONFIGURATION command can be used in **Configuration** mode to restore all configuration parameters to their default values.

This command is equivalent to using the DEFAULT function in **Configuration** mode.



NOTE: All load cell calibration settings are lost when the RESETCONFIGURATION command is run.

6.1.4 Parameter Setting Commands

Parameter setting commands allow the display or change of the current value for a particular configuration parameter (Table 6-3 on page 61 through Table 6-19 on page 67).

Current configuration parameter settings can be displayed in either **Configuration** mode or **Weigh** mode using the following syntax:

command<CR>

Most parameter values can be changed in **Configuration** mode only.

Use the following command syntax when changing parameter values:

command=value<CR>

where **value** is the new value you want to assign to the parameter. Use no spaces before or after the equal (=) sign. If an incorrect command has been typed in, the response will be **??**.

For example, to set the motion band parameter to 5, type the following:

SC.MOTBAND#1=5D<CR>

For parameters with selectable values, enter the command and equal sign followed by a question mark:

command=?<CR>

to see a list of those values. The indicator must be in **Configuration** mode to use this function.

6.1.5 Scales Menu

Command	Menu	Description	Choices / Range
SC.ACCUM#1	Accumulator	Accumulator of weighments	OFF, ON
SC.DFTHR#1	Digital Filter Threshold	Digital filter cutoff threshold	0-99999
SC.DSPRATE#1	Display Update Rate	Display Update Rate (in 0.1 sec intervals)	1-80
SC.DFSENS#1	Digital Filter Sensitivity	Digital filter cutoff sensitivity	LIGHT,MEDIUM,HEAVY
SC.GRADS#1	Graduations	Graduations to determine capacity	1 - 100000
SC.MOTBAND#1	Motion Band	Motion Band (in display divisions)	0-100
SC.OVRLOAD#1	Overload	Overload point based on capacity	FS+2%, FS+1D, FS+9D, FS
SC.OVRLOAD_VAL#1	Enter Percentage	Overload point based on percentage of capacity	0.0 - 150.0
SC.PWRUPMD#1	Powerup Mode	Power Up Mode	GO, DELAY
SC.RANGE1.MAX#1	Range-1 Max	Maximum weight for first range or interval	0.0 - 999999.0
SC.RANGE2.MAX#1	Range-2 Max	Maximum weight for second range or interval	0.0 - 999999.0
SC.RANGE3.MAX#1	Range-3 Max	Maximum weight for third range or interval	0.0 - 999999.0
SC.SMPRAT#1	Sample Rate	Scale Sample Rate	7.5HZ, 15HZ, 30HZ, 60HZ, 120HZ, 240HZ, 480HZ, 960HZ
SC.SPLIT#1	Multi Ranges	Specifies full range, multi-range, or multi-interval	OFF, 2RNG, 3RNG, 2INTVL, 3INTVL
SC.SSTIME#1	Standstill Time	Stand still time (in 0.1 sec intervals)	1 - 65535
SC.TAREFN#1	Tare Function	Tare Function	BOTH, NOTARE, PBTARE, KEYED
SC.THRESH#1	Accumulate Threshold	Accumulator Zero Threshold	0 - 999999
SC.ZRANGE#1	Zero Range	Zero range (in %)	0.0 - 100.0
SC.ZTRKBND#1	Zero Track Band	Zero track band (in divisions)	0.0 - 100.0

Table 6-3. Scale EDP Commands

6.1.6 Format Menu

Command	Menu	Description	Choices / Range
If SPLIT = 2RNG, 3RNG, 2INTVL, 3INTVL			
SC.PRI.DPCPNT#1	DP Location-1	Decimal point location for first range or interval	888888, 888880, 8.88888, 88.8888, 888.888, 8888.88, 88888.8
SC.SEC.DPCPNT#1	DP Location-2	Decimal point location for second range or interval	888888, 888880, 8.88888, 88.8888, 888.888, 8888.88, 88888.8
SC.TER.DPCPNT#1	DP Location-3	Decimal point location for third range or interval. Only available in 3RNG or 3INTVL	888888, 888880, 8.88888, 88.8888, 888.888, 8888.88, 88888.8
SC.PRI.DSPDIV#1	Range-1 DD	Range/Interval (1 division size)	1D, 2D, 5D
SC.SEC.DSPDIV#1	Range-2 DD	Range/Interval (2 division size)	1D, 2D, 5D
SC.TER.DSPDIV#1	Range-3 DD	Range/Interval (3 division size) Only available in 3RNG or 3INTVL.	1D, 2D, 5D
If SPLIT = OFF			
SC.PRI.UNITS#1	Primary Units	Specifies primary units for displayed and printed weight	LB, KG, OZ, TN, T, G, NONE
SC.SEC.UNITS#1	Secondary Units	Specifies secondary units for displayed and printed weight	LB, KG, OZ, TN, T, G, NONE

Table 6-4. Format EDP Commands

6.1.7 Calibration Menu

Command	Menu	Description	Choices / Range
SC.WZERO#1	Calibrate Zero	Perform zero calibration	–
SC.WSPAN#1	Calibrate Span	Perform span calibration	–
SC.LC.CD#1	Zero Counts	Get/Set Calibration Zero value	-8388607 to 8388607
SC.LC.CW#1	Gain Counts	Get/Set Calibration Gain value	-8388607 to 8388607
SC.LC.CZ#1	Zero Counts	Get/Set Calibration Zero value	-2147483646 to 2147483647
SC.REZERO#1	Rezero	Perform Calibration Re-Zero	–
SC.WLIN.C1#1	Calibration Point - 1	Calibrate linearization point 1	–
SC.WLIN.C2#1	Calibration Point - 2	Calibrate linearization point 2	–
SC.WLIN.C3#1	Calibration Point - 3	Calibrate linearization point 3	–
SC.WLIN.C4#1	Calibration Point - 4	Calibrate linearization point 4	–
SC.WLIN.C5#1	Calibration Point - 5	Calibrate linearization point 5	–
SC.WLIN.F1#1	MultiPoint Cal-1	Raw count value for linearization point 1	-2147483646 to 2147483647
SC.WLIN.F2#1	MultiPoint Cal-2	Raw count value for linearization point 2	-2147483646 to 2147483647
SC.WLIN.F3#1	MultiPoint Cal-3	Raw count value for linearization point 3	-2147483646 to 2147483647
SC.WLIN.F4#1	MultiPoint Cal-4	Raw count value for linearization point 4	-2147483646 to 2147483647
SC.WLIN.F5#1	MultiPoint Cal-5	Raw count value for linearization point 5	-2147483646 to 2147483647
SC.WLIN.V1#1	Cal Point-1 Weight	Test weight value for linearization point 1	0.0 - 999999.0
SC.WLIN.V2#1	Cal Point-2 Weight	Test weight value for linearization point 2	0.0 - 999999.0
SC.WLIN.V3#1	Cal Point-3 Weight	Test weight value for linearization point 3	0.0 - 999999.0
SC.WLIN.V4#1	Cal Point-4 Weight	Test weight value for linearization point 4	0.0 - 999999.0
SC.WLIN.V5#1	Cal Point-5 Weight	Test weight value for linearization point 5	0.0 - 999999.0
SC.WVAL#1	Test Weight	Test weight value for standard gain calibration	0.00001 - 999999.0

Table 6-5. Calibration EDP Commands



NOTE: The menu items, CAL1 – CAL5 are used to do the calibration. A value cannot be keyed in. The SC.WLIN.Fx#1 EDP commands can be used to view and edit the value but they do not perform the calibration. Use the SC.WLIN.Cx#1 commands to perform the calibration.

6.1.8 Fiber COM Menu

Command	Menu	Description	Choices / Range
EDP.BAUD#1	Baud	Port baud rate	*1200, *2400, *4800, 9600, 19200, 28800, 38400, 57600, 115200 *not available on port 3
EDP.BITS#1	Bits	Port data bits and parity	8NONE, 7EVEN, 7ODD
EDP.ECHO#1	Echo	Specifies whether characters received by the port are echoed back to the sending unit	OFF, ON
EDP.EOLDLY#1	End of Line Delay	Port end-of-line delay in 0.1 sec intervals	Range: 0 - 255
EDP.TYPE#1	Type	Specifies RS-232 or RS-422 communication	232, 422
EDP.PRMSG#1	Print Message	Print message	OFF, ON
EDP.RESPONSE#1	Response	Response	OFF, ON
EDP.SFMT#1	Stream Format	Stream format	Alphanumeric, Max Length: 200
EDP.STOPBITS#1	Stop Bits	Stop Bits	1, 2
EDP.TERMIN#1	Termination	Termination character	CR/LF, CR
EDP.TRIGGER#1	Trigger	Selects the operation of the port	COMAND, STRLFT, STRIND, REMOTE

Table 6-6. Port (COM) EDP Commands

6.1.9 Stream Tokens Menu

Command	Description	Default	Choices / Range
STR.GROSS	String transmitted for the <M> token for gross weight	G	Alphanumeric, Max Length: 8
STR.INVALID	String transmitted for the <S> token when weight is invalid	I	Alphanumeric, Max Length: 2
STR.MOTION	String transmitted for the <S> token when scale is in motion	M	Alphanumeric, Max Length: 2
STR.NEG	Character transmitted for the <P> token when the weight is negative	-	NONE, SPACE, -
STR.NET	String transmitted for the <M> token for net weight	N	Alphanumeric, Max Length: 8
STR.OK	String transmitted for the <S> token when the scale is ok	" "	Alphanumeric, Max Length: 2
STR.POS	Character transmitted for the <P> token when the weight is positive	SPACE	NONE, SPACE, +
STR.PRI	String transmitted for the <U> token for primary units	L	Alphanumeric, Max Length: 8
STR.RANGE	String transmitted for the <S> token when the scale is out of range	O	Alphanumeric, Max Length: 2
STR.SEC	String transmitted for the <U> token for secondary units	K	Alphanumeric, Max Length: 8
STR.TARE	String transmitted for the <M> token for tare weight	T	Alphanumeric, Max Length: 8
STR.ZERO	String transmitted for the <S> token when the scale is at center of zero	Z	Alphanumeric, Max Length: 2

Table 6-7. Stream Tokens EDP Commands

6.1.10 Feature Menu

Command	Menu	Description	Choices / Range
DATEFMT	Date Format	Date Format	MMDDYY, DDMMYY, YYMMDD, YYDDMM, MMDDY4 , DDDMMY4, Y4MMDD, Y4DDMM
DECfmt	Decimal Format	Decimal Format	DOT, COMMA
GRAVADJ	Gravity Adjust	Must be enabled for latitude and elevation	OFF, ON
LAT.LOC	Latitude	Latitude (Gravity adjust must be set to ON)	0-90
ELEV.LOC	Elevation	Elevation (Gravity adjust must be set to ON)	-9999-9999
UID	Unit ID	Unit Identifier	Alphanumeric, Max Length: 6
DATESEP	Date Separator	Date separator character	SLASH, DASH, SEMI, TIMEFMT
TIMEFMT	Time Format	Time format	12HOUR, 24HOUR
TIMESEP	Time Separator	Time separator character	COLON, COMMA

Table 6-8. Feature EDP Commands

6.1.11 Regulatory Menu

Command	Menu	Description	Choices / Range
REGWORD	Regulatory Word	Term printed when weighing in Gross mode	GROSS, BRUTTO
REGULAT	Regulatory	Regulatory agency having jurisdiction over the scale site	NONE, OIML, NTEP, CANADA, INDUST
REG.AGENCY	Audit Agency	Audit trail agency format	NONE, OIML, NTEP, CANADA
REG.BASE	Overload Base	Zero preference for overload calculation CALIB - Calibrated zero SCALE - Pushbutton zero	CALIB, SCALE
REG.CTARE	Clear Tare	CLEAR key – clear tare/accumulator while viewing	NO, YES
REG.RTARE	Round Tare	Round push button tare to nearest Display Division.	YES,NO
REG.KTARE	Keyed Tare	Keyed tare	NO, YES
REG.MTARE	Multiple Tare Action	Multiple tare action	NOTHIN, REPLAC, REMOVE
REG.NTARE	Negative Tare	Negative or zero tare	NO, YES
REG.PRTMOT	Print Motion	Print while in motion	NO, YES
REG.PRINTPT	Add PT to Print	Add "PT" to keyed tare print	NO, YES
REG.SNPSHOT	Select Weight Source	Selects display or scale weight source	DISPLAY, SCALE
REG.ZTARE	Zero Tare	Remove tare on ZERO	NO, YES

Table 6-9. Regulatory EDP Commands

6.1.12 Passwords Menu

Command	Menu	Description	Choices / Range
PWD.USER	User	Used to protect items in the top level menu	Range: 0 - 999999
PWD.SETUP	Setup	Used to protect items in the setup menu	Range: 0 - 999999

Table 6-10. Password EDP commands



NOTE: The EDP commands can be used to set the passwords but they will not return the current password setting.

6.1.13 Keypad Lock Menu

Command	Menu	Description	Choices / Range
KEYLCK.FUNCTION	Function Keys	Lock or unlocks the Function Keys	LOCK, UNLOCK
KEYLCK.GROSSNET	Gross/Net	Locks or unlocks the Gross/Net Key	LOCK, UNLOCK
KEYLCK.MENU	Menu	Locks or unlocks the Menu Key	LOCK, UNLOCK
KEYLCK.NUMERIC	Numeric Keypad	Locks or unlocks the Numeric Keypad Keys	LOCK, UNLOCK
KEYLCK.PRINT	Print	Locks or unlocks the Print Key	LOCK, UNLOCK
KEYLCK.TARE	Tare	Locks or unlocks the Tare Key	LOCK, UNLOCK
KEYLCK.UNITS	Units	Locks or unlocks the Units Key	LOCK, UNLOCK
KEYLCK.ZERO	Zero	Locks or unlocks the Zero Key	LOCK, UNLOCK

Table 6-11. Keypad Lock EDP Commands

6.1.14 Print Format Menu

The Menu items (except for HDRFMT) are listed by the format and the sub-parameters.

Command	Menu	Description	Choices / Range
ACC.FMT	Accumulator Format	Accumulator enabled and displayed	Alphanumeric, Max Length: 1000
ACC.PORT	Accumulator Port	Accumulator print port	COM, FIBER, IOCOM, IOCOMUSB, ETHSERVER, ETHCLIENT, OFF
GFMT.FMT	Gross Format Format	Weigh mode, no tare in system	Alphanumeric, Max Length: 1000
GFMT.PORT	Gross Format Port	Weigh mode, no tare in system, print port	COM, FIBER, IOCOM, IOCOMUSB, ETHSERVER, ETHCLIENT, OFF
HDRFMT1	Header Format	Must be inserted into other print format	Alphanumeric, Max Length: 300
NFMT.FMT	Net Format Format	Weigh mode, tare in system	Alphanumeric, Max Length: 1000
NFMT.PORT	Net Format Port	Weigh mode, tare in system, print port	COM, FIBER, IOCOM, IOCOMUSB, ETHSERVER, ETHCLIENT, OFF

Table 6-12. Print Format EDP Commands



NOTE: See [Section 7.2 on page 69](#) for more detailed information on print format commands.

6.1.15 Digital I/O Configuration Menu

Command	Menu	Choices / Range
DIO.b#s	BIT x	OFF, PRINT, ZERO, TARE, UNITS, CLEAR, DSPACC, DSPTAR, NT/GRS, CLRCN, OUTPUT, KBDLOC, GROSS, NET, PRIM, SEC, CLRTAR, CLRACC

Table 6-13. Digital I/O Configuration EDP Commands



NOTE: Digital inputs and outputs are specified by bit number ($b = 1$ or 2) and slot number ($s = 0$).

6.1.16 Weigh Mode Commands

Weigh mode commands (Table 6-14) transmit data to a data communications port on demand. SX, EX, and all the X weight retrieval commands are valid only in normal operating mode; all other commands are valid in either setup or **Weigh** mode.

See Section 10.3 on page 79 for error command definitions.

Command	Function
AT	Acquire tare
DISPLAYMSG#n	Displays a message on the indicated line (n); Example: DISPLAYMSG#3=abc
SX#1	Start serial port streaming; If port is configured to stream on port #3; (3=Ethernet Server)
SX	Start serial port streaming for the port receiving the command, if port is configured to stream
EX#1	Stop serial port streaming for the port receiving the command, if port is configured to stream; 1=COM, 2=FiberOptic
EX	Stop serial port streaming for the port receiving the command, if port is configured to stream
RS	Reset system; This is a soft reset; Used to reset the indicator without resetting the configuration to the factory defaults
S	Sends a single stream frame from the scale to the port in the format defined by the Stream Format parameter of the port receiving the command
XA#1	Transmit accumulator value in displayed units for scale n
XA	Transmit accumulator value in displayed units for selected scale
XAP#1	Transmit accumulator value in primary units for scale n
XAS#1	Transmit accumulator value in secondary units for scale n
XG#1	Transmit gross weight in displayed units for scale n
XG	Transmit gross weight in displayed units for selected scale
XG2	Transmit gross weight in non-displayed units for selected scale
XGP#1	Transmit gross weight in primary units for scale n
XGS#1	Transmit gross weight in secondary units for scale n
XN#1	Transmit net weight in displayed units for scale n
XN	Transmit net weight in displayed units for selected scale
XN2	Transmit net weight in non-displayed units for selected scale
XNP#1	Transmit net weight in primary units for scale n
XNS#1	Transmit net weight in secondary units for scale n
XT#1	Transmit tare weight in displayed units for scale n
XT	Transmit tare weight in displayed units for selected scale
XT2	Transmit tare weight in non-displayed units for selected scale
XTP#1	Transmit tare weight in primary units for scale n
XTS#1	Transmit tare weight in secondary units for scale n
XE	Returns a decimal representation of any error conditions
XEH	Returns a hexadecimal representation of any error conditions

Table 6-14. Weigh Mode EDP Commands



NOTE: The 882IS/882IS Plus only supports one scale therefore X commands are displayed with a #1.

6.1.17 Power Commands

Command	Menu	Description	Choices/Range
BACKLIGHT	Backlight Control	Manual control of whether the backlight is ON or OFF	OFF, ON
BATTERYINSTALLED	Battery Installed	Manual control of whether the indicator is being powered by a battery (yes) or not (no)	NO, YES
POWERSAVINGMODE	Power Saving Mode	Selects which type of automatic power saving is to be performed after 30 seconds of no activity (scale motion, keypress, or serial command received); the 30 second timer restarts if a condition of no activity happens; OFF = none; LIGHT = turns off backlight; MEDIUM = turns off backlight and display; AGGRESSIVE = turns off backlight, excitation and display	OFF, LIGHT, MEDIUM, AGGRESSIVE
SLEEPTIMER	Sleep Timer	Countdown time, in seconds, to enter Power Saving mode; Default value is 30 seconds	15 - 99999
WAKETHRESHOLD	Wake Threshold	Once asleep, if the primary weight goes above this value the indicator will wake; A value of 0 will prevent indicator from waking due to a weight change - only a keypress or serial command will wake the unit	0.0 - 9999999.0

Table 6-15. Power EDP Commands

6.1.18 Setup Mode Commands

Command	Menu	Description	Choice/Range
RESETCONFIGURATION	Default	Resets all configuration parameters to their default values and clears the scale calibration	-

Table 6-16. Setup Mode Commands

The RESETCONFIGURATION command can be used in **Configuration** mode to restore all configuration parameters to their default values.

This command is equivalent to using the DEFAULT function in **Configuration** mode.



NOTE: All load cell calibration settings are lost when the RESETCONFIGURATION command is run.

6.1.19 Analog Output Parameters

Command	Menu	Description	Choice/Range
ALG.ERRACT#n	Error Action	Specifies how the analog output responds to system error conditions	FULLSC: Sets to full value (10 V or 20 mA) HOLD: Holds the last value ZEROSC: Sets to zero value (0 V or 4 mA)
ALG.MAX#n	Maximum Value	Specifies the maximum weight value tracked by the analog output	0.000001 - 9999800.0
ALG.MAXNEG#n	Maximum Negative	Specifies ON if the maximum weight (MAX parameter) is a negative value	ON: The maximum value is negative OFF: The maximum value is positive
ALG.MIN#n	Minimum Value	Specifies the minimum weight value tracked by the analog output	0.0 - 9999800.0
ALG.MINNEG#n	Minimum Negative	Specifies ON if the minimum weight (MIN parameter) is a negative value	ON: The minimum value is negative OFF: The minimum value is positive
ALG.MODE#n	Mode	Specifies the weight data, Gross or Net, tracked by the analog output	GROSS: Tracks the gross weight NET: Tracks the net weight
ALG.OUTPUT#n	Output	Specifies the output type: 0-10 V, 0-20 mA, or 4-20 mA output NOTE: This parameter must be set before calibrating the analog output.	0-10 V: 0-10 volt output 0-20 mA: 0-20 mA output 4-20 mA: 4-20 mA output

Table 6-17. Analog Output Parameters

6.1.20 Analog Output Commands

Command	Menu	Description	Choice/Range
ALG.ENTERSPANCAL#n	–	Enters the mode for calibrating the analog output span; This is needed only if calibrating through EDP commands	OK or ??
ALG.EXITSPANAL#n	–	Exits the mode for calibrating the analog output span; This is needed only if calibrating through EDP commands; This must be done before the results of the calibration are implemented	OK or ??
ALG.ENTERZEROCAL#n	–	Enters the mode for calibrating the analog output zero; This is needed only if calibrating through EDP commands	OK or ??
ALG.EXITZEROCAL#n	–	Exits the mode for calibrating the analog output zero; This is needed only if calibrating through EDP commands. This must be done before the results of the calibration are implemented	OK or ??
ALG.SPAN#n	Calibrate Span	Enter the observed output value to calibrate the analog output span; Use a multimeter to monitor the analog output value	0.0 - 30.0
ALG.ZERO	Calibrate Zero	Enter the observed output value to calibrate the analog output zero; Use a multimeter to monitor the analog output value	0.0 - 30.0

Table 6-18. Analog Output Commands

6.1.21 Test Commands

Command	Menu	Description	Choice/Range
BATTERYCOUNTS	Battery Counts	The A2D count value taken from the battery that is used as an indicator of battery life	32600 (5.45 V - critical error voltage) - 36000 (6.05 V - fully charged battery) These count ranges are approximate

Table 6-19. Test Commands

7.0 Print Formatting

The 882IS/882IS Plus provides four print formats. Formats **Gross Format** and **Net Format** will be printed based on the current mode of operation when the **Print** key is pressed (Table 7-2 on page 69). **Header Format** can be inserted into any other print format using the <H1> formatting token. The **Accumulator Format** is printed if the accumulator is enabled and the print key is pressed while viewing the accumulator value.

Each print format can be customized to include up to 1000 characters of information (300 for **Header Format**), such as company name and address. Use the indicator front panel (**Print Format** menu), EDP commands, or the Revolution[®] configuration utility to customize the print formats.

7.1 Print Formatting Tokens

Table 7-1 lists tokens that can be used to format the 882IS/882IS Plus print formats. Tokens included in the format strings must be enclosed between < and > delimiters. Any characters outside of the delimiters are printed as text. Text characters can include any ASCII character that can be printed by the output device.

Tokens	Description
<G>	Gross weight in displayed units (See notes 1 and 2 below)
<ID>	User ID (see Section 3.2.2 on page 30)
<N>	Net weight in displayed units (See notes 1 and 2)
<T>	Tare weight in displayed units (See notes 1 and 2)
<A>	Accumulated weight in displayed units
<AC>	Number of accumulator event (5-digit counter)
<AT>	Time of last accumulator event
<AD>	Date of last accumulator event
<TI>	Time
<DA>	Date
<TD>	Time and date
<UID>	Unit ID number (See note 3)
<CN>	Consecutive number (See note 3)
<H1>	Ticket header (HDRFMT)
<NLnn>	New line (nn = number of termination (<CR/LF> or <CR>) characters) (See note 4)
<nnn>	ASCII character (nnn = decimal value of ASCII character); Used for inserting control characters (STX, for example) in the print stream
<SPnn>	Space (nn = number of spaces) (See note 4)
<SU>	Toggle weight data format (formatted/unformatted) (See note 5)
<CR>	Carriage return character
<LF>	Line feed character

Table 7-1. Print Format Tokens



NOTE: 1. Gross, net, and tare weights are 8 digits in length, including sign and decimal point, followed by a space and a one- to five-digit units identifier. Total field length with units identifier is 10-14 characters. Depending on what units are configured, the units identifier will be lb, kg, oz, tn, t, or g.

2. Gross, net, tare, and accumulator weights can be printed in any configured weight units by adding the following modifiers to the gross, net, tare, and accumulator weight commands: /P (primary units), /D (displayed units), /S (secondary units), /T (tertiary units). If not specified, the current displayed units (/D) is assumed.

Example: To format a ticket to show net weight in secondary units, use the following command: <N/S>.

3. Unit ID and consecutive number (CN) fields are 1–6 characters in length, as required.

4. If nn is not specified, 1 is assumed. Value must be in the range 1–99.

5. After receiving an SU token, the indicator sends unformatted data until the next SU token is received. Unformatted data omits decimal points, leading and trailing characters.

7.2 Default Print Formats

Table 7-2 shows default print formats for the 882IS/882IS Plus and lists the conditions under which each print format is used.

Format	Default	Used When
GROSS FORMAT FMT	GROSS<G><NL2><TD><NL>	Weigh mode, no tare in system
GROSS FORMAT PORT	COM	Defines the communication port that the format will be sent to
NET FORMAT FMT	GROSS<G><NL>TARE<SP><T><NL>NET<SP2><N><NL2><TD><NL>	Weigh mode, tare in system
NET FORMAT PORT	COM	Defines the communication port that the format will be sent to
ACCUMULATOR FORMAT FORMAT	ACCUM<A><NL><DA> <T><NL>	Accumulator enabled and displayed
ACCUMULATOR FORMAT PORT	COM	Defines the communication port that the format will be sent to
HEADER FORMAT FORMAT	COMPANY NAME<NL> STREET ADDRESS<NL>CITY,ST ZIP<NL2>	The Header Format is used to specify header information that can be used by the other print formats; The contents of the Header Format can be inserted into any other print format using the <H1> formatting token

Table 7-2. Default Print Formats



NOTE: In OIML and CANADA modes, the letters **PT** (preset tare) are automatically inserted after the printed tare weight.

7.3 Customizing Print Formats

The following sections describe procedures for customizing print formats using the EDP commands, the front panel (**Print Format** menu), and the Revolution configuration utility.

7.3.1 Using the EDP Commands

With a personal computer, terminal, or remote keyboard attached to the 882IS/882IS Plus, the EDP command set can be used to customize the print format strings.

To view the current setting of a format string, type the name of the print format, followed by .FMT, and press **Enter**. For example, to check the current configuration of the **Gross Format**, type **GFMT.FMT** and press **Enter**. The indicator responds by sending the current configuration for the gross format:

```
GROSS<G><NL2><TD><NL>
```

To change the format, use the format EDP command followed by an equals sign (=) and the modified print format string. For example, to add the name and address of a company to the gross format, send the following EDP command:

```
GFMT.FMT=RICE LAKE WEIGHING SYSTEMS<NL>230 W COLEMAN ST<NL>RICE LAKE WI 54868<NL2><G>
GROSS<NL>
```

A ticket printed using this format might look like the following:

```
RICE LAKE WEIGHING SYSTEMS
230 W COLEMAN ST
RICE LAKE WI 54868
```

```
1345 LB GROSS
```

The ticket above could also be formatted by specifying the company address information in the **Header Format** ticket format, then substituting the <H1> token for the address in the **Gross Format** ticket format:

```
HDRFMT1=RICE LAKE WEIGHING SYSTEMS<NL>230 W COLEMAN ST<NL>RICE LAKE WI
54868<NL2>GFMT=<AE><G> GROSS<NL>
```



NOTE: The **HDRFMT1** command does not require the .FMT.

7.3.2 Using the Front Panel

If there is no access to equipment for communication through the communication ports or when working at a site where such equipment cannot be used, the **Print Format** menu (see [Section 3.2.15 on page 42](#)) can be used to customize the print formats. Using the **Print Format** menu, edit the print format strings by changing the decimal values of the ASCII characters in the format string.



NOTE: Edit the format using the **Alphanumeric Entry Procedure** ([Section 1.9.2 on page 15](#)).

Some special characters cannot be displayed on the 882IS/882IS Plus front panel (see the ASCII character chart in [Section 10.9 on page 85](#)) and are shown as blanks. The 882IS/882IS Plus can send or receive any ASCII character; The character printed depends on the particular ASCII character set implemented for the receiving device.

7.3.3 Using Revolution

The Revolution configuration utility provides a print formatting grid with a tool bar. The grid allows the construction of the print format without the formatting tokens (<NL> and <SP>) required by the front panel or EDP command methods. Using Revolution, type text directly into the grid, then select weight value fields from the tool bar and place them where they are to appear on the printed ticket.

[Figure 7-1](#) shows an example of the Revolution print formatting grid.

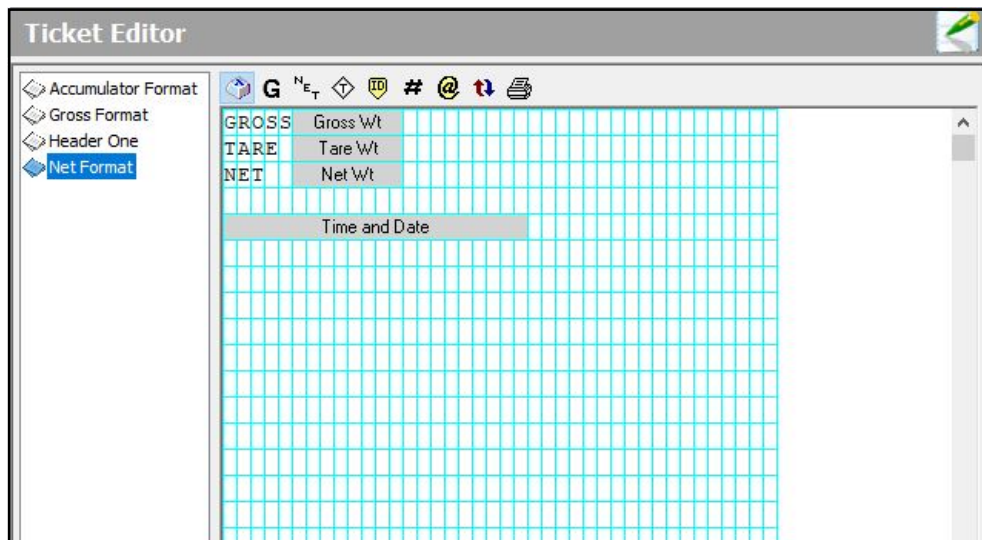

Figure 7-1. Revolution Print Format Grid

8.0 Setpoints

The 882IS/882IS Plus indicator is capable of controlling setpoint batching on a remote Rice Lake Weighing Systems 920i weight indicator. This capability enables an industrial batching engine to run in a safe environment, controlled by the 882IS/882IS Plus through a fiber-optic cable from a hazardous area. See Figure 8-1 to see examples of how this is set up. With a special iRite program, the 920i is capable of running as a serial scale with batching setpoints controlled by the 882IS/882IS Plus indicator.

The 882IS/882IS Plus has the ability to configure the value of setpoints 1-10, given the setpoints are already enabled on the 920i, for control of both indicator and external equipment functions. The 882IS/882IS Plus has the ability to control a batch operation that has been set up on a 920i (located in the safe area) and can support:

- Batch Start
- Batch Stop
- Batch Pause
- Batch Reset

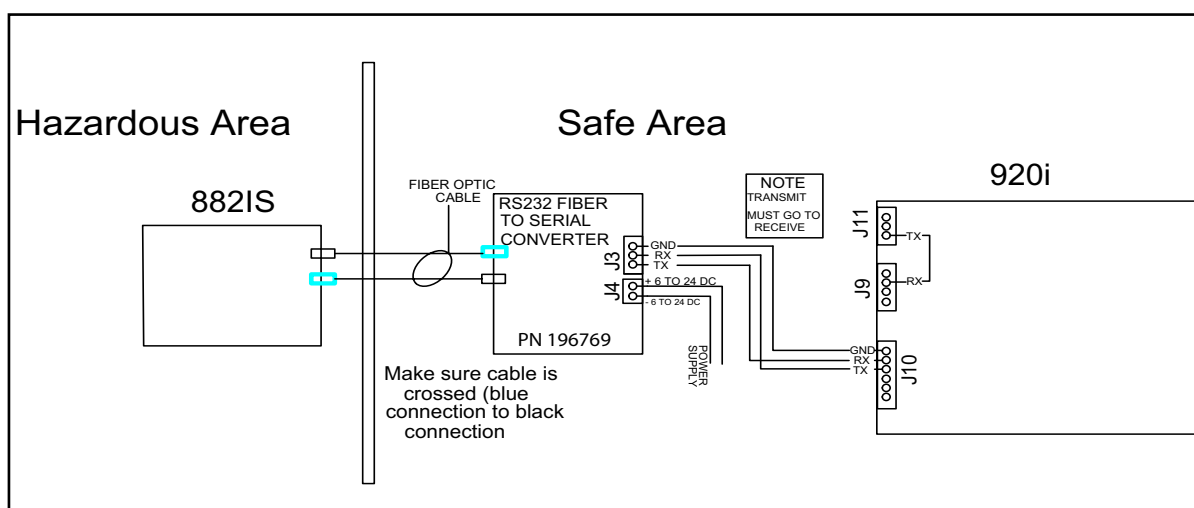

Figure 8-1. 882IS/882IS Plus Remote Setpoints RS-232 Hardware Model Example

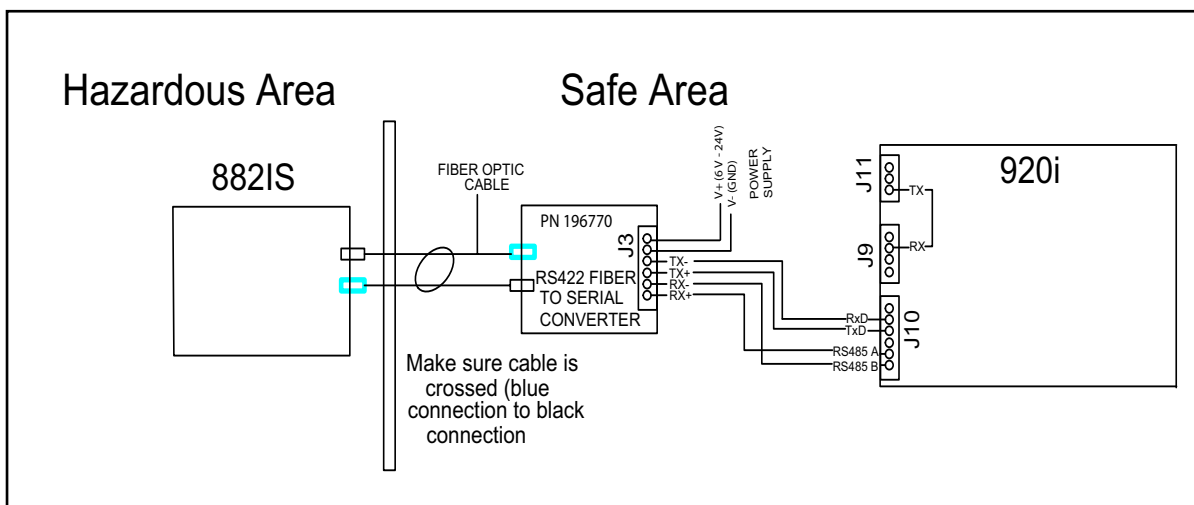

Figure 8-2. 882IS/882IS Plus Remote Setpoints RS-422 Hardware Model Example



NOTE: Weight-based setpoints are tripped by values specified in primary units only. A jumper is required from J11 pin 3 to J9 pin 2.

8.1 Hardware Requirements

- 920i Digital Weight Indicator - Firmware version 4.0 or greater with fiber-optic port option
- 882IS/882IS Plus Digital Weight Indicator - Firmware version 1.05 or greater
- Fiber-optic cable for setpoint batching control
- Serial cable for 920i configuration - optional
- Fiber to serial converter (PN 196769 - RS-232) or (PN 196770 - RS-422)
- Serial jumper wire from 920i port 1 to port 3

8.2 Software Requirements

- iRite special program 201804.cod running inside the 920i
- iRev file 201804.920 loaded into the 920i - Firmware version 4.0 or newer



NOTE: The iRite program must be running inside of the 920i before remote setpoints are available.

8.3 Connect the Fiber-Optic Cable

A fiber-optic cable is used to communicate between the 882IS/882IS Plus and a 920i fiber-optic converter option. Depending on the site requirements, the converter can be either:

- RS-232 fiber to serial converter box (PN 196769) (Figure 8-1 on page 71)
- RS-422 fiber to serial converter box (PN 196770) (Figure 8-2 on page 71)



IMPORTANT: Use anti-static protection for grounding and to protect components from electrostatic discharge (ESD) when working inside the enclosures.

Disconnect the fiber optic to serial converter box from power source before opening.

The fiber optic to RS-232 or RS-422 serial converter box is equipped with a duplex fiber-optic port for communicating with an 920i indicator located in the safe area. It provides electrical isolation and eliminates the use of IO barriers commonly used in intrinsically safe systems. The optical fibers are plastic and the terminated ends must be properly polished prior to installation. Refer to POF Polishing Kit (PN 197384), for complete instructions. See Figure 8-3 for the location of the duplex fiber-optic port in the fiber optic to RS-232 serial or the RS-422 serial converter box.

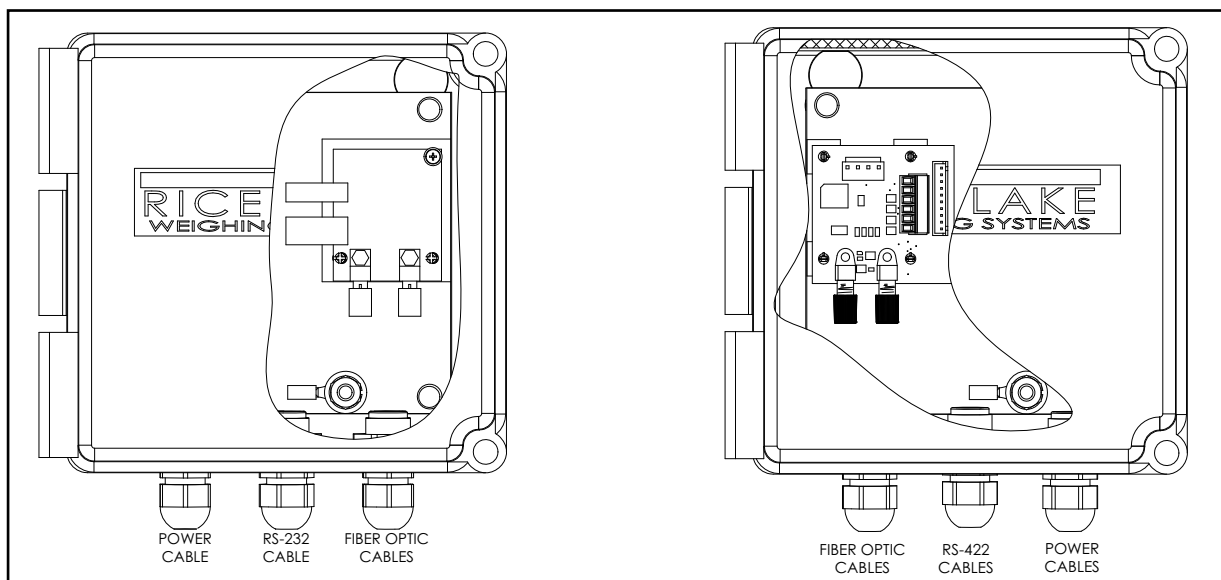

Figure 8-3. Fiber-optic Board Location (RS-232 Adapter Box PN 196769) and (RS-422 Adapter Box PN 196770)



NOTE: The fiber-optic connections between the 882IS/882IS Plus and the RS-232 or RS422 converter needs to be cross-linked (blue connection to black connection). The optical output of the indicator should be attached to the input of the converter, and the indicator input to the module output.

Use the following steps for assembling the fiber-optic connectors of the fiber-optic to RS-232 serial or the RS-422 serial converter box:

1. Cut off the ends of the fiber-optic cable, with a proper cutting tool such as a fiber-optic hot knife (PN 85548) or cutting block (PN 80892).

 **NOTE:** Ensure there are no bends 90° or greater in the fiber-optic cable.

 **NOTE:** The cut end of the fiber-optic cable must be cut flush so that the core and outside insulation are equal. Core exposure can lead to failure.

2. Polish the fiber ends per the fiber polishing kit.
3. Insert the fiber-optic cable through the locking nut and into the connector until the core tip seats against the internal micro-lens; then back it out 1/16" (1 mm).
4. Screw the connector locking nut down to a snug fit, locking the fiber-optic cable in place.

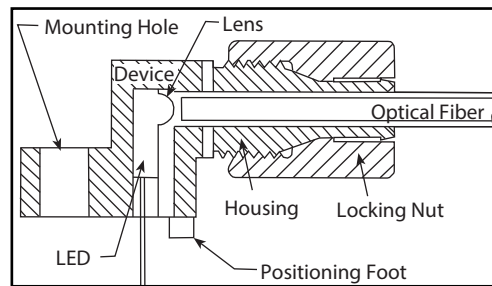

Figure 8-4. Fiber Optics Connector

5. Connect the power source for the fiber optic to serial converter box.

8.4 920i iRite Software Setup Procedure

Use the following steps to load the iRite software program into the 920i indicator.

1. Connect a serial cable between a PC and the 920i indicator.
2. Press the configuration switch on the 920i and verify that the 920i is in **Configuration** mode.

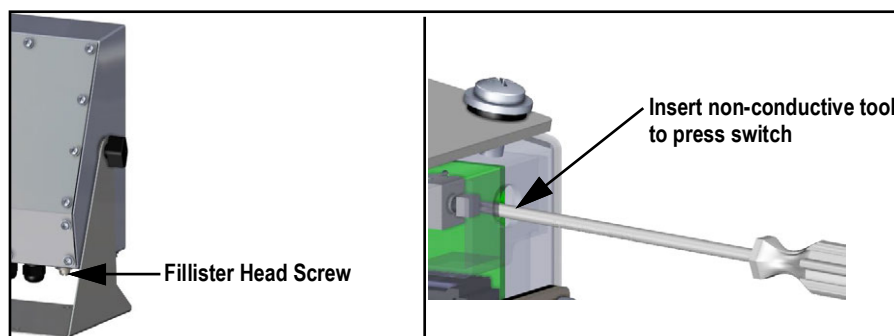

Figure 8-5. 920i Configuration Switch Location

3. On the PC, launch iRev for the 920i, V4.0 or newer.
4. Press the Connect button in iRev to connect to the 920i.
5. Unzip the 201804.zip file.
6. Using iRev, download the configuration contained within the 201804.920 file and 201804.cod file to the 920i indicator which will configure the scales, serial ports, the display and some default setpoints.

8.5 920i Setup Procedure

Use the following steps to set up the 920i indicator.



NOTE: To edit a setpoint value, the setpoint must be already enabled in the 920i. The 920i setpoint must previously be configured active.

The 920i batching process must be in reset state or not previously been started.

A maximum of seven digits can be configured for each of the 10 setpoint values.

Setpoint values on the 882IS/882IS Plus will not become active on the 920i indicator until the value is successfully entered on the 882IS/882IS Plus.

1. Wire up connections from the RS-232 Fiber Adapter to the 920i indicator (Figure 8-1 on page 71) for connections.
2. Wire port 1 on the 920i to port 3 on the 920i by jumpering TX and RX where scale 1 gets its input coming from port 3 on the 920i and scale 2 being the program scale which gets its weight from 882IS/882IS Plus and streams out of port 1.
3. Under setpoints, the 920i needs to have at least one or more setpoints active with an associated value and batching turned ON. Below are shown some examples:
 Setpoint #1: GROSS, Value 1234.5, Batching ON
 Setpoint #2: GROSS, Value 2345.6, Batching ON
 Setpoint #3: GROSS, Value 3456.7, Batching ON
 Setpoint #4: GROSS, Value 4567.8, Batching ON
 Setpoint #5: GROSS, Value 5678.9, Batching ON
4. Download the configuration and setpoints with iRev then press **Save and Exit** on the 920i indicator to enable the serial scale and batching setpoints.

8.6 882IS/882IS Plus Setup Procedure

Use the following steps to set up the 882IS/882IS Plus indicator.

1. Configure the fiber-optic serial port Trigger=Setpoint.
2. Configure the fiber-optic serial port to 9600 baud, Echo=Off, Response=Off.
3. Save and exit **Setup** mode using the **Menu** key.
4. The 882IS/882IS Plus weight being displayed on the 920i verifies the 882IS/882IS Plus remote serial scale setpoint batcher is configured correctly and ready to go.



NOTE: If using a decimal point in the 882IS/882IS Plus, an equivalent setting must be set for the 920i scale 2 format.

8.7 Setpoint Configuration Procedure

Use the following steps to configure the setpoints.

1. The 882IS/882IS Plus weight being displayed on the 920i verifies the 882IS/882IS Plus remote serial scale setpoint batcher is configured and wired correctly and is ready for operation.
2. To configure batching setpoints, a batch has to be not started or in Reset. Reset the batch by pressing the **F4** key.
3. Configure a setpoint value by pressing the **Menu** key followed by one left arrow, Setpoints display on the 882IS/882IS Plus.
4. Press the down arrow. Setpoint #1 displays.
5. Right and left arrows can be used to navigate between Setpoint #1 and Setpoint #10.
6. Once the desired setpoint # is found, press the down arrow.
7. If the setpoint is configured to Off, the screen displays SP#n=OFF. This setpoint cannot be changed.
8. If the setpoint is configured to something other than Off, a setpoint value edit screen displays.
 SP#1 Value =
9. The value appears.
 SP#1 Value = 1234.500 with the leftmost digit blinking - meaning that it is ready to edit.
10. Use up or down arrows to increment or decrement the values.



NOTE: If using the 882IS/882IS Plus, with numeric keypad, the value can be directly keyed in.

11. Right and left arrows move the blinking edit cursor.



NOTE: Refer to the 882IS/882IS Plus Intrinsicly Safe Indicator Technical Manual (PN 183532) for value edit procedures.

12. When editing the value is complete, press **Enter** (TARE). This operation sends the setpoint value to the 920i indicator. The 882IS/882IS Plus screen automatically advances to the next setpoint value #.
13. When all of the desired setpoint values have been edited, exit setup and go to **Weigh** mode by pressing the up-arrow key followed by the **Menu** key.

8.8 Setpoint Batching

Use the 882IS/882IS Plus F-keys to control the 920i's batching operation. The F-keys are as follows:

- F1 - Batch Start
- F2 - Batch Stop
- F3 - Batch Pause
- F4 - Batch Reset

When the F-keys are pressed on the 882IS/882IS Plus, the 920i displays the following:

- F1 - Batch Started
- F2 - Batch Stopped
- F3 - Batch Paused
- F4 - Batch Reset



NOTE: The 920i will show **Error Stopping Batch** if the 882IS/882IS Plus F2 (stop) button is pushed with no batch currently running.

The 882IS/882IS Plus will also display the current batch status: **Batch Running**, **Batch Stopped**, **Batch Paused**, **Batch Complete**.

8.9 920i Batch Operations



NOTE: Once the 201804.cod and 201804.920 files are downloaded to the 920i, softkeys will be shown (Figure 8-6) and operate in normal batching operation.

Softkeys allow the operator control of batch operations from the 920i front panel (Figure 8-6) once the download of 201804.cod and 201804.920 files are complete.

Softkeys can be configured using iRev 4, serial commands or the FEATURE menu once the download of 201804.cod and 201804.920 files are complete.

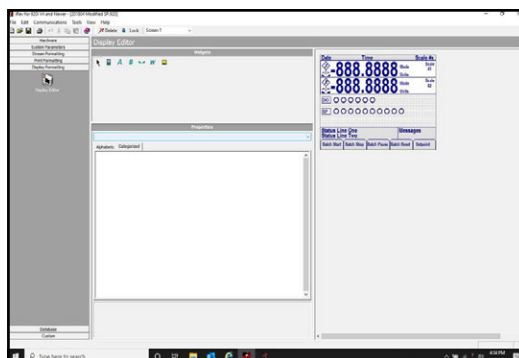

Figure 8-6. 920i Batching Softkeys

Batch Start – Starts batch process.

Batch Stop – Stops an active batch and turns off all associated digital outputs.

Batch Pause – Pauses an active batch and turns off all digital outputs except those associated with concurrent and timer setpoints. Processing is suspended until **Batch Start** is pressed again. Pressing **Batch Start** resumes the batch and re-energizes all digital outputs turned off by the **Batch Pause**.

Batch Reset – Stops and resets an active batch to the beginning of the process.

Setpoint – Display or change assigned setpoints.



WARNING: To prevent personal injury and equipment damage, software-based interrupts must always be supplemented by emergency stop switches and other safety devices necessary for the application.



NOTE: When a batch is currently running and the 882IS/882IS Plus goes to an over-range condition, the 920i will pause the batch and show **Paused - 882IS/882IS Plus Scale** and both scale 1 and scale 2 will illustrate as dashes.

When a batch is currently running and communication is lost between the 882IS/882IS Plus and the 920i, the 920i will pause the batch and show **No Comm with 882IS/882IS Plus** and both scale 1 and scale 2 will show as dashes.

Pausing a batch deactivates all digital outputs with the exception of those tied to **Concur** and/or **Timer** setpoints.

9.0 IO Module

The 882IS/882IS Plus IO Module is an external device designed for use with the 882IS/882IS Plus digital weight indicators. When placed in the safe area, its fiber optic interface allows it to provide remote functions for indicators in hazardous environments. The 882IS/882IS Plus IO Module provides access to the indicator through the following:

- USB device connection
- Ethernet
- One comm port (RS-232 or RS-422)
- One option card slot

9.1 IO Module Disassembly

The 882IS/882IS Plus IO module enclosure must be opened to connect cables for communications.



WARNING: The IO module does not have an On/Off switch. Before opening the unit, ensure power to the unit is disconnected.

9.1.1 AC Wiring

The IO Module is to be permanently mounted (safe area) with a readily accessible disconnect device incorporated in the building installation wiring. All wiring is to be done in accordance with the National Electric Code (NEC).

9.1.2 RS-232/RS-422 Communications

To attach a PC or other device to the 882IS' RS-232 or the two-wire RS-422 ports, select RS-422 standard in the indicator Serial menu for the IO Module. See [Table 9-1](#) for information on connecting RS-422 communications.

Pin	RS-232	RS-422
1	GND	GND
2	RX	B
3	TX	A

Table 9-1. J3 Pin Assignments (Port 1 Serial Communications)

9.2 USB Device Communications – Port 2



NOTE: If using Windows 7 or later, and the PC is connected to the Internet, the operating system may be able to install the drivers without any interaction.

Before the USB Device Port can be used, drivers must be installed on the PC.

1. Have power applied to the PC and to the indicator.
2. Connect a USB cable from the PC to the micro USB connector (J4) on the 882IS/882IS Plus IO Module. The PC recognizes that a device has been connected and will attempt to install the drivers needed to make it work. Those drivers can be downloaded from the Rice Lake Weighing Systems website at www.ricelake.com.
3. When the individual drivers are installed, a new COM Port designation is assigned for each physical USB port the 882IS/882IS Plus is connected to on the PC.

Example: If the PC already has two physical RS-232 COM Ports, they most likely are designated COM1 and COM2. When connecting the indicator to a USB port on the PC, it will be assigned the next available port designation, or in this case, COM3. When plugging into the same physical USB port on the PC, the port designation will again be COM3. If plugging into another physical USB port on the PC, it will be assigned the next available designation, in this case COM4.

After the drivers are installed, use Windows Device Manager to determine the COM Port designation that was assigned to the USB port. Or open the application that is to be used with the 882IS, such as Revolution, and see which ports are available.

Configuration of the USB Device Port is done in the USB Communications sub-menu under IO MODULE PORTS in **Configuration** mode ([Section 3.2.13 on page 40](#)).

The port can be configured as either a demand port for EDP commands and printing, or a data streaming port. Other settings include the termination character(s); enabling echoes and responses; adjust the end-of-line delay; and whether or not the indicator displays a 'print' message when a print format sends data out the port.



NOTE: If a computer application has an open communications connection through the USB Device Port, and the physical cable connection is interrupted, a soft reset is performed on the indicator or power is cycled to the indicator; the connection in the computer application must be disconnected and reconnected again before it will continue to communicate with the indicator.

For the USB Device Port, it does not matter what the settings are for Baud, Data Bits, Parity and Stop Bits in the computer software. The port will communicate in the same way regardless of these settings.

This port is not a host port and is not intended to be connected to other devices such as keyboards, memory sticks or printers.

9.3 Ethernet Communications

The 882IS/882IS Plus features Ethernet TCP/IP 10Base-T/100Base-TX communication using a standard RJ45 connector (J6 – Figure 9-1). It can support two simultaneous connections, one as a server, the other as a client.

Through an Ethernet network, software applications are able to communicate with the 882IS/882IS Plus using the EDP command set

(Section 6.0 on page 59), or data can be streamed continuously from the indicator, or printed on demand.

The Ethernet port supports both DHCP and manual configuration of settings such as the IP and subnet. In addition, the TCP Port number, Primary and Secondary DNS, and the Default Gateway can be configured using the Ethernet sub-menu of the Ports setup menu. For more information on configuring the Ethernet port see Section 3.2.13 on page 40.

Physical connection to the 882IS/882IS Plus Ethernet port can be made directly from a PC to the 882IS/882IS Plus (AdHoc Network), or through a network router or switch. The port supports auto-sensing MDI/MDIX cable configuration, so either straight-through or crossover cables can be used.

The RJ45 Ethernet jack on the 882IS/882IS Plus houses two LEDs to indicate the status and speed of the connection.

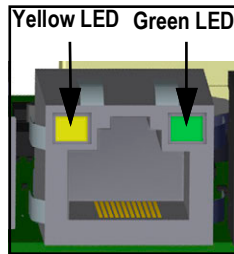

Figure 9-1. RJ45 Ethernet Jack

Yellow LED (left) indicates the status of the connection:

- Off for no link
- On for a link
- Blinking if there is activity

Green LED (right) is:

- Off for a 10Base-T connection
- On for a 100Base-TX connection

9.4 Updating IO Module Firmware

Revolution is used to update the 882IS/882IS Plus IO module firmware. The link to begin this process is available on the Revolution home screen. Updating the firmware defaults configuration settings. For additional information on jumper position and steps on updating firmware, see the 882IS/882IS Plus I/O Module Installation Manual (PN 194139).

10.0 Appendix

10.1 Error Messages

The 882IS/882IS Plus indicator provides a number of error messages. When an error occurs, the message is shown on the indicator display. Error conditions can also be checked remotely by using the XE EDP command as described in [Section 10.3 on page 79](#).

10.1.1 Displayed Error Messages

The 882IS/882IS Plus provides a number of front panel error messages to assist in problem diagnosis. [Table 10-1](#) lists these messages and their meanings.

Error Message	Description	Solution
— — — — —	Over range	Check for improper load cell wiring, configuration, calibration, scale hardware problems
— — — — —	Under range	
— — — — — (center dashes)	A/D out of range; Or if using local/remote (serial scale) - loss of serial scale data	
CFGERR	Configuration error on power up if there was an error loading configuration	Press the Enter key to reboot the indicator
ERROR	Internal program error	Check configuration
HWFERR	Hardware failure error on failure to write to the EEPROM any error (except for a battery error or an accumulation over range error) when exiting the menu	Press the Enter key to reboot the indicator
NOTARE	Tare is prevented because of regulatory mode settings, the configuration of the TAREFN parameter, motion on the scale, etc.	Change regulatory mode settings or the TAREFN parameter
RANGE	A numeric value entered in configuration is out of the acceptable range; The error displays momentarily – then parameter being edited displays so the value can be corrected	Re-enter a value that is in range for the parameter being edited
NO ZERO	Zero is prevented (due to regulatory mode settings, motion on the scale, zero range settings)	Check zero settings and for motion

Table 10-1. 882IS/882IS Plus Error Messages

10.2 Using the HARDWARE Command

The HARDWARE serial command can be used to verify that installed option cards are recognized by the system. The HARDWARE command returns a three-digit card code, representing the card installed:

Code	Card Type
000	No card installed
153	Analog Output Card
170	Fieldbus Option Card

Table 10-2. HARDWARE Command Option Card Type Codes

If an installed card is not recognized (HARDWARE command returns code of 000), ensure that the card is seated properly. Reinstall the card, if necessary, then cycle the power to read the configuration again. If the card is still not recognized, try a different option card.

10.3 ERROR Commands Output

XE and XEH commands return a representation of any existing error conditions as described in the following table. If more than one error condition exists, the number returned is the sum of the values representing the error conditions. The XE command returns the value as a decimal representation and the XEH command returns the value as a hexadecimal representation.

XE Error Code (Decimal)	Description	XEH Error Code (Hexadecimal)
0	No Errors	0x00000000
1	Configuration Signature Error	0x00000001
2	Parameter Checksum Error	0x00000002
4	Loadcell Data Checksum Error	0x00000004
8	Print Format Checksum Error	0x00000008
64	Battery Power Low Voltage Error	0x00000040
32768	Gravity Compensation Error	0x00008000
65536	A/D Physical Error	0x00010000
131072	Tare Storage Checksum Error	0x00020000
262144	Accumulator Overflow Error	0x00040000

Table 10-3. Error Commands Output

10.4 Status Messages

The EDP command **P** can be used to provide status about the indicator.

- The **P** EDP command returns whatever is currently shown in the indicator's primary display area.

PPPPPP uu

where:

- PPPPPP** is the information shown on the primary display
- uu** is the 2-digit units annunciator

If indicator is in an underrange or overload condition, weight value is replaced with **&&&&&&** (overload) or **::::::** (underrange).

10.5 TARE and ZERO Key Functions

The function of the front panel **Tare** and **Zero** keys depend on the value specified for the Regulation parameter in the Features menu (Figure 3-10 on page 36). Table 10-4 describes the function of these keys for each of the regulatory modes.

Regulation Parameter Value	Weight on Scale	Tare in System	Front Panel TARE Key or KTARE command (Tare Enable – Tare function setting)			Front panel ZERO key or KZERO command
			KEYED	PBONLY	BOTH	
NTEP	Zero or negative	No	Keyed prompt (1)	No action	Keyed prompt (1)	Zero
		Yes	Keyed prompt (2)	Clear tare	Keyed prompt (2)	Zero
	Positive	No	Keyed prompt (1)	Tare	Tare	Zero
		Yes	Keyed prompt (2)	Tare	Tare	Zero
CANADA	Zero or negative	No	Keyed prompt (1)	No action	Keyed prompt (1)	Zero
		Yes	Keyed prompt (2)	Clear tare	Keyed prompt (2)	Zero
	Positive	No	No Action	Tare	Tare	Zero
		Yes	No Action	No action	No Action	Zero
OIML	Zero or negative	No	Keyed prompt (1)	No action	Keyed prompt (1)	Zero
		Yes	Keyed prompt (2)	Clear tare	Keyed prompt (2)	Zero and clear Tare (3)
	Positive	No	Keyed prompt (1)	Tare	Tare	Zero
		Yes	Keyed prompt (2)	Tare	Tare	Zero and clear Tare (3)
NONE	Zero or negative	No	Keyed prompt (1)	Tare	Keyed prompt (1)	Zero
		Yes	Keyed prompt (2)	Clear tare	Keyed prompt (2)	Zero
	Positive	No	Keyed prompt (1)	Tare	Tare	Zero
		Yes	Keyed prompt (2)	Clear tare	Clear tare	Zero

NOTES:

- Entering a Zero tare will cancel the entry. Any other value will be accepted as a Keyed Tare.
- Entering a Zero tare will clear the current Tare. Any other value will be accepted as a Keyed Tare.
- The indicator will Zero and Clear the Tare only if the gross weight is within Zero Range. No action is taken if the weight is outside of Zero Range.

Table 10-4. Tare and Zero Key Functions for REGULA Parameter Settings

Table 10-5 lists the sub-parameters available when configuring a scale using INDUST mode. The table includes the default values of the INDUST sub-parameters and the effective (not configurable) values used by NTEP, CANADA, OIML and NONE regulatory modes

REGULA/INDUST Parameter		Regulation Mode				
Parameter	Description	INDUST	NTEP	CANADA	OIML	NONE
SNPSHT	Display or Scale weight source	DISPLAY	DISPLAY	DISPLAY	DISPLAY	SCALE
ZTARE	Remove tare on ZERO	NO	NO	NO	YES	YES
KTARE	Always allow keyed tare	YES	YES	NO	YES	YES
MTARE	Multiple Tare Action	REPLAC	REPLAC	NOTHIN	REPLAC	REMOVE
NTARE	Allow negative tare	NO	NO	NO	NO	YES
CTARE	Allow CLEAR tare to clear tare	YES	YES	YES	NO	YES
RTARE	Round push button tare to nearest Display Division.	YES	YES	YES	NO	YES
PRTMOT	Allow print while in motion	NO	NO	NO	NO	YES
PRTPT	Add PT to keyed tare print	NO	NO	YES	YES	NO
OVRBAS	Zero base for overload calculation	CALIB	CALIB	CALIB	SCALE	CALIB

Table 10-5. REGULA/INDUST Mode Parameters, Comparison with Effective Values of Regulatory Modes

10.6 Data Formats

10.6.1 Stream Serial Data Format

If stream data transmission is configured for a port (STRLFT or STRIND), by default the 882IS/882IS Plus sends data using the Rice Lake Weighing Systems serial data format shown in Figure 10-1.

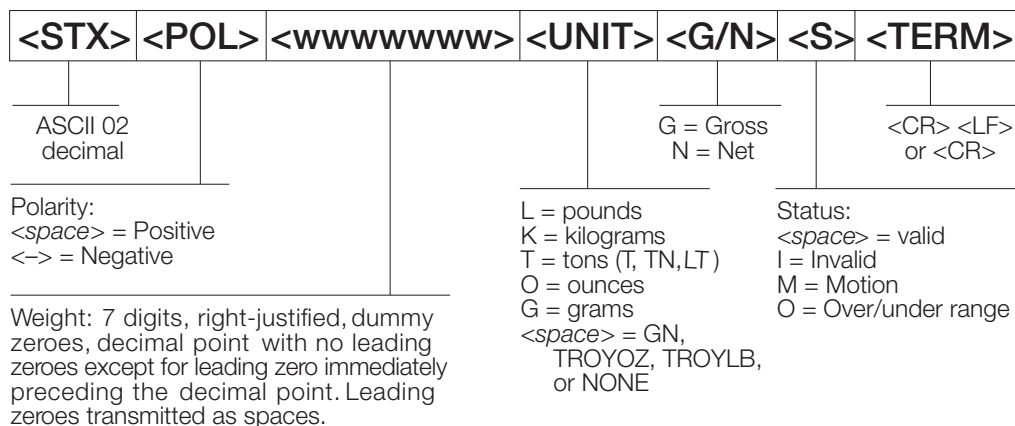

Figure 10-1. Stream Serial Data Format

Stream Format parameter default – <2><P><W7.><U><M><S><CR><LF>



NOTE: Format can be changed (Section 10.7 on page 81).

The character values can be changed for the stream format tokens (Table 6-7 on page 63).

10.6.2 Print Output Serial Data Format

The 882IS/882IS Plus uses a data string format for a basic ticket printout. The print format is configured in the setup menu for the demand (print) port, and depends on the indicator configuration and mode. See Section 7.0 on page 68 for print formatting.

Use the EDP commands, Revolution or the front panel to fully customize the print to work with a wide variety of printers and other remote equipment.

10.7 Custom Stream Formatting – Input/Output

The format of the streamed data can be configured for any of the ports individually using the front panel, EDP commands or Revolution using the tokens in [Table 10-6](#). Configuration is available for stream input/output tokens through EDP commands only; no front panel access is provided.

Format Identifier	Defined By	Description
<P[G N T]>	STR.POS STR.NEG	Polarity; Outputs the positive or negative polarity label for the current or specified (Gross/Net/Tare) weight on the source scale; Possible values are SPACE, NONE, + (for STR.POS), or – (for STR.NEG)
<U[P S T]>	STR.PRI STR.SEC STR.TER	Units; Outputs the primary, secondary, or tertiary* units label for the current or specified (Primary/Secondary/Tertiary*) weight on the source scale
<M[G N T]>	STR.GROSS STR.NET STR.TARE	Mode; Outputs the gross, net, or tare label for the current or specified weight (Gross/Net/Tare) on the source scale
<S>	STR.MOTION STR.RANGE STR.OK STR.INVALID STR.ZERO	Outputs the status for the source scale; Default values and meanings for each status: STR.MOTION M In motion STR.RANGE O Out of range STR.OK <space> OK STR.INVALID I Invalid STR.ZERO Z COZ
<B [-]n,...>	See descriptions below	Bit fields; Comma-separated sequence of bit field specifiers; Must be exactly 8 bits; Minus sign ([–]) inverts the bit
B0	-	Always 0
B1	-	Always 1
B2	Configuration	=1 if even parity
B3	Dynamic	=1 if MODE=NET
B4	Dynamic	=1 if COZ (center of zero)
B5	Dynamic	=1 if motion
B6	Dynamic	=1 if displayed gross or net weight is negative
B7	Dynamic	=1 if out of range
B8	Dynamic	=1 if secondary/tertiary*
B9	Dynamic	=1 if tare in system
B10	Dynamic	=1 if tare is keyed
B11	Dynamic	=00 if MODE=GROSS =01 if MODE=NET =10 if UNITS=TERTIARY* =11 (not used)
B12	Dynamic	=00 if UNITS=PRIMARY =01 if UNITS=PRIMARY =10 if UNITS=PRIMARY =11 (note used)
B13	Configuration	=00 (not used) =01 if current DSPDIV=1 =10 if current DSPDIV=2 =11 if current DSPDIV=5
B14	Configuration	=00 (not used) =01 if primary DSPDIV=1 =10 if primary DSPDIV=2 =11 if primary DSPDIV=5
B15	Configuration	=00 (not used) =01 if secondary DSPDIV=1 =10 if secondary DSPDIV=2 =11 if secondary DSPDIV=5

Table 10-6. Custom Stream Format Identifiers

Format Identifier	Defined By	Description
B16	Configuration	=00 (not used) =01 if tertiary* DSPDIV=1 =10 if tertiary* DSPDIV=2 =11 if tertiary* DSPDIV=5
B17	Configuration	=000 (not used) =001 if current DECPNT=888880 =010 if current DECPNT=888888 =011 if current DECPNT=88888.8 =100 if current DECPNT=8888.88 =101 if current DECPNT=888.888 =110 if current DECPNT=88.8888 =111 if current DECPNT=8.88888
B18	Configuration	=000 (not used) =001 if primary DECPNT=888880 =010 if primary DECPNT=888888 =011 if primary DECPNT=88888.8 =100 if primary DECPNT=8888.88 =101 if primary DECPNT=888.888 =110 if primary DECPNT=88.8888 =111 if primary DECPNT=8.88888
B19	Configuration	=000 (not used) =001 if secondary DECPNT=888880 =010 if secondary DECPNT=888888 =011 if secondary DECPNT=88888.8 =100 if secondary DECPNT=8888.88 =101 if secondary DECPNT=888.888 =110 if secondary DECPNT=88.8888 =111 if secondary DECPNT=8.88888
B20	Configuration	=000 (not used) =001 if tertiary* DECPNT=888880 =010 if tertiary* DECPNT=888888 =011 if tertiary* DECPNT=88888.8 =100 if tertiary* DECPNT=8888.88 =101 if tertiary* DECPNT=888.888 =110 if tertiary* DECPNT=88.8888 =111 if tertiary* DECPNT=8.88888
<wspec [-] [0] digit[.][.]digit>	Scale weight	Weight for the source scale. wspec is defined as follows: wspec Indicates whether the weight is the current displayed weight (W, w), gross (G, g), net (N, n), or tare (T, t) weight; Upper-case letters specify right-justified weights; Lower-case are left-justified; Optional /P, /S, or /T suffixes can be added before the ending delimiter (>) to specify weight display in primary (/P), secondary (/S), or tertiary* (/T) units; [-] Enter a minus sign (-) to include sign for negative values; [0] Enter a zero (0) to display leading zeros; digit[.][.]digit; The first digit indicates the field width in characters – range is 1-7; Decimal point only indicates floating decimal; Decimal point with following digit (range is 1-5) indicates fixed decimal with n digits to the right of the decimal; Two consecutive decimals send the decimal point even if it falls at the end of transmitted weight field
<CR>	-	Carriage return, hex 0x0D, ASCII decimal 13
<LF>	-	Line feed, hex 0x0A, ASCII decimal 10
<SPnn>	-	Space, nn = number of spaces; If nn is not specified, 1 is assumed; Value must be in the range 1-99
<NLnn>	TERMIN setting of the port	New line, nn = number of termination (<CR/LF> or <CR>) characters; If nn is not specified, 1 is assumed; Value must be in the range 1-99; NOTE: When streaming data, a configured End-of-Line Delay is performed after each New Line.
<nnn>	-	ASCII character (nnn = decimal value of ASCII character); Used for inserting control characters (<002> for an STX, for example) in the output
* Tertiary (Range/Interval 3)		

Table 10-6. Custom Stream Format Identifiers (Continued)

10.8 Stream Formatting Examples

10.8.1 Toledo 8142 Indicator

Sample string for Toledo 8142 indicator (with no checksum):

<STX><Status Word A><Status Word B><Status Word C><wwwwww><ttttt><EOL>

882IS/882IS Plus stream format configuration:

<02><B2, B0, B1, B13, B17><B2, B0, B1, B8, B5, B7, B6, B3><B2, B0, B1, B0, B0, B0, B0, B0><W6><T6><CR>

Identifier	Description
<STX>	The STX character is entered into the string using the <02> hex value.
<Status Word A>	Toledo status words are made up of various bit fields; NOTE: Identifiers must be entered beginning with the high-order bit (bit 7–bit 0) of the Toledo status word. Status Word A contains the following fields. Equivalent 882IS/882IS Plus format identifiers are shown in parentheses Bit 7: parity (B2) Bit 6: always 0 (B0) Bit 5: always 1 (B1) Bits 3–4: display divisions (B13) Bits 0–2: decimal format (B17)
<Status Word B>	Status Word B contains the following fields; Equivalent 882IS/882IS Plus format identifiers are shown in parentheses Bit 7: parity (B2) Bit 6: always 0 (B0) Bit 5: always 1 (B1) Bit 4: lb/kg units (B8) Bit 3: stable/motion (B5) Bit 2: in/out-of-range (B7) Bit 1: pos/neg (B6) Bit 0: gross/net (B3)
<Status Word C>	Status Word C contains the following fields; Equivalent 882IS/882IS Plus format identifiers are shown in parentheses Bit 7: parity (B2) Bit 6: always 0 (B0) Bit 5: always 1 (B1) Bits 0–4: always 0 (B0)
<wwwwww>	The <W6> and <T6> indicate six digits of indicated weight and tare weight; Valid characters are W, w, G, g, T, t, N, or n (lower case indicates left justified); W indicates current weight, G gross weight, N net weight, and T tare weight. /P and /S can be used to specify primary or secondary; Minus indicates sign inclusion, and (0) indicates leading zeros; First digit indicates field width in characters; Decimal indicates floating decimal point; Decimal with subsequent digit indicates fixed decimal with <i>n</i> digits to the right of the decimal; Two consecutive decimals (for example, <W06..>); send the decimal point even if it falls at the end of the transmitted weight field.
<ttttt>	Tare weight; See description above
<EOL>	<CR> is entered at the end of the string as the end of line character in this example

Table 10-7. Toledo Sample String Identifiers

10.8.2 Cardinal 738 Indicator

Sample string for the Cardinal 738 indicator:

```
<CR><POL><wwwwww><S><SP><units><SP><G/N><SP><SP><EOL>
```

882IS/882IS Plus stream format configuration:

```
<CR><P><W07.><S><SP><U><SP><M><SP2><03>
```

Identifier	Description
<CR>	Carriage Return
<POL>	Cardinal uses + for positive and – for negative, so the stream polarity tokens need to reflect this; The EDP commands for the 882IS/882IS Plus are STR.POS=+ and STR.NEG= –
<wwwwwww>	The <W07.> identifier that the 882IS/882IS Plus recognizes indicates seven digits of weight with a decimal and leading zeros, with the decimal being sent at the end of the weight; Valid characters are W, w, G, g, T, t, N, or n (lower case indicates left justified); W indicates current weight, G gross weight, N net weight, T tare weight. /P and /S can be used to specify primary or secondary; Minus indicates sign inclusion, while (0) indicates leading zeros; First digit indicates field width in characters; Decimal indicates floating decimal point; Decimal with subsequent digit indicates fixed decimal with <i>n</i> digits to the right of the decimal; Two consecutive decimals (for example, <W06.>) send the decimal point even if it falls at the end of the transmitted weight field
<S>	There are four possible tokens for status bits that can be used: motion, out-of-range, valid, and invalid; In the Cardinal, m indicates motion, o indicates out-of-range, and a space is used for valid or invalid weights; The commands to set these tokens in the 882IS/882IS Plus are STR.MOTION=m, STR.RANGE=o, STR.OK= , STR.INVALID= NOTE: Although it appears that there are no commands for OK and INVALID, there is a space entered with the keyboard before pressing the Enter key.
<SP>	Space
<units>	The Cardinal uses two-character, lower-case units identifiers; The commands to set these tokens in the 882IS/882IS Plus include: STR.PRI=lb (options: kg, g, tn, t, gr, oz, or sp), STR.SEC=kg (options: lb, g, tn, t, gr, oz, or sp)
<SP>	Space
<G/N>	The mode used for Cardinal is <i>g</i> for gross and <i>n</i> for net; These tokens are set using the STR.GROSS= <i>g</i> and STR.NET= <i>n</i> tokens
<SP>	Space
<SP>	Space
<EOL>	The end of line character is an ETX in this case so the hex value of <03> is entered in the string

Table 10-8. Cardinal Sample String Identifiers

10.8.3 Weightronix WI 120 Indicator

Sample string for the Weightronix WI120 indicator:

```
<SP><G/N><POL><wwwwww><SP><units><EOL>
```

882IS/882IS Plus stream format configuration:

```
<SP><M><P><W06.><SP><U><CR><LF>
```

Identifier	Description
<SP>	Space
<G/N>	Mode used for Weightronix is <i>G</i> for gross and <i>N</i> for net; These tokens are set using the STR.GROSS= <i>G</i> and STR.NET= <i>N</i> tokens
<POL>	Since the Weightronix uses + for positive and – for negative, the polarity tokens need to reflect this; The EDP commands for the 882IS/882IS Plus are STR.POS=+ and STR.NEG= –
<wwwwwww>	The <W06.> that the 882IS/882IS Plus recognizes indicates six digits of weight with a decimal and leading zeros; Valid characters are W, w, G, g, T, t, N, or n (lower case indicates left justified); W indicates current weight, G gross weight, N net weight, and T tare weight; /P and /S can be used to specify primary or secondary; Minus indicates sign inclusion, while (0) indicates leading zeros; First digit indicates field width in characters; Decimal indicates floating decimal point; Decimal with subsequent digit indicates fixed decimal with <i>n</i> digits to the right of the decimal; Two consecutive decimals (for example, <W06.>) send the decimal point even if it falls at the end of the transmitted weight field
<SP>	Space
<units>	The Weightronix uses two-character, lower-case units identifiers; The commands to set these tokens in the 882IS/882IS Plus include: STR.PRI=lb (options: kg, g, tn, t, gr, oz, or sp), STR.SEC=kg (options: lb, g, tn, t, gr, oz, or sp)
<EOL>	<CR> or <CR> and <LF>

Table 10-9. Weightronix Sample String Identifiers

10.9 ASCII Character Chart

Use the decimal values for ASCII characters listed in [Table 10-10](#) and [Table 10-11 on page 86](#) when specifying print format strings in the 882IS/882IS Plus Print Format menu or serial stream formats. The actual character printed depends on the character mapping used by the output device.

The 882IS/882IS Plus can send or receive any ASCII character value (decimal 0–255). Due to limitations of the indicator display, some characters cannot be shown.

Control	ASCII	Dec	Hex	ASCII	Dec	Hex	ASCII	Dec	Hex	ASCII	Dec	Hex
Ctrl-@	NUL	00	00	space	32	20	@	64	40	`	96	60
Ctrl-A	SOH	01	01	!	33	21	A	65	41	a	97	61
Ctrl-B	STX	02	02	"	34	22	B	66	42	b	98	62
Ctrl-C	ETX	03	03	#	35	23	C	67	43	c	99	63
Ctrl-D	EOT	04	04	\$	36	24	D	68	44	d	100	64
Ctrl-E	ENQ	05	05	%	37	25	E	69	45	e	101	65
Ctrl-F	ACK	06	06	&	38	26	F	70	46	f	102	66
Ctrl-G	BEL	07	07	'	39	27	G	71	47	g	103	67
Ctrl-H	BS	08	08	(40	28	H	72	48	h	104	68
Ctrl-I	HT	09	09)	41	29	I	73	49	i	105	69
Ctrl-J	LF	10	0A	*	42	2A	J	74	4A	j	106	6A
Ctrl-K	VT	11	0B	+	43	2B	K	75	4B	k	107	6B
Ctrl-L	FF	12	0C	,	44	2C	L	76	4C	l	108	6C
Ctrl-M	CR	13	0D	-	45	2D	M	77	4D	m	109	6D
Ctrl-N	SO	14	0E	.	46	2E	N	78	4E	n	110	6E
Ctrl-O	SI	15	0F	/	47	2F	O	79	4F	o	111	6F
Ctrl-P	DLE	16	10	0	48	30	P	80	50	p	112	70
Ctrl-Q	DC1	17	11	1	49	31	Q	81	51	q	113	71
Ctrl-R	DC2	18	12	2	50	32	R	82	52	r	114	72
Ctrl-S	DC3	19	13	3	51	33	S	83	53	s	115	73
Ctrl-T	DC4	20	14	4	52	34	T	84	54	t	116	74
Ctrl-U	NAK	21	15	5	53	35	U	85	55	u	117	75
Ctrl-V	SYN	22	16	6	54	36	V	86	56	v	118	76
Ctrl-W	ETB	23	17	7	55	37	W	87	57	w	119	77
Ctrl-X	CAN	24	18	8	56	38	X	88	58	x	120	78
Ctrl-Y	EM	25	19	9	57	39	Y	89	59	y	121	79
Ctrl-Z	SUB	26	1A	:	58	3A	Z	90	5A	z	122	7A
Ctrl-[ESC	27	1B	;	59	3B	[91	5B	{	123	7B
Ctrl-\	FS	28	1C	<	60	3C	\	92	5C		124	7C
Ctrl-]	GS	29	1D	=	61	3D]	93	5D	}	125	7D
Ctrl-^	RS	30	1E	>	62	3E	^	94	5E	~	126	7E
Ctrl- <u>_</u>	US	31	1F	?	63	3F	_	95	5F	DEL	127	7F

Table 10-10. ASCII Character Chart (Part 1)

ASCII	Dec	Hex	ASCII	Dec	Hex	ASCII	Dec	Hex	ASCII	Dec	Hex	ASCII
Ç	128	80	á	160	A0		192	C0	a	224	E0	Ç
ü	129	81	í	161	A1		193	C1	b	225	E1	ü
é	130	82	ó	162	A2		194	C2	G	226	E2	é
â	131	83	ú	163	A3		195	C3	p	227	E3	â
ä	132	84	ñ	164	A4		196	C4	S	228	E4	ä
à	133	85	Ñ	165	A5		197	C5	s	229	E5	à
á	134	86	ª	166	A6		198	C6	m	230	E6	á
ç	135	87	º	167	A7		199	C7	t	231	E7	ç
ê	136	88	¿	168	A8		200	C8	F	232	E8	ê
ë	137	89		169	A9		201	C9	Q	233	E9	ë
è	138	8A	¬	170	AA		202	CA	W	234	EA	è
ï	139	8B	½	171	AB		203	CB	d	235	EB	ï
î	140	8C	¼	172	AC		204	CC	¥	236	EC	î
ì	141	8D	ì	173	AD		205	CD	f	237	ED	ì
Ä	142	8E	«	174	AE		206	CE	í	238	EE	Ä
Å	143	8F	»	175	AF		207	CF	Ç	239	EF	Å
É	144	90		176	B0		208	D0	°	240	F0	É
æ	145	91		177	B1		209	D1	±	241	F1	æ
Æ	146	92		178	B2		210	D2	³	242	F2	Æ
ô	147	93		179	B3		211	D3	£	243	F3	ô
ö	148	94		180	B4		212	D4	ó	244	F4	ö
ò	149	95		181	B5		213	D5	ô	245	F5	ò
û	150	96		182	B6		214	D6	¸	246	F6	û
ù	151	97		183	B7		215	D7	»	247	F7	ù
ÿ	152	98		184	B8		216	D8	°	248	F8	ÿ
Ö	153	99		185	B9		217	D9	·	249	F9	Ö
Ü	154	9A		186	BA		218	DA		250	FA	Ü
ç	155	9B		187	BB		219	DB		251	FB	ç
£	156	9C		188	BC		220	DC		252	FC	£
¥	157	9D		189	BD		221	DD	²	253	FD	¥
Pts	158	9E		190	BE		222	DE		254	FE	Pts
f	159	9F		191	BF		223	DF		255	FF	f

Table 10-11. ASCII Character Chart (Part 2)

10.10 Digital Filtering

Digital filtering can be used to create a stable scale reading in challenging environments. The 882IS/882IS Plus has two filtering methods that can be set; Sample rate and Digital filter.

10.10.1 Sample Rate

The Sample rate should be set first. Better stability is achieved with a lower sample rate setting, so 7.5 Hz is more stable than 120 Hz.

10.10.2 Digital Filter

The digital filter is an adaptive filter that has two parameters to set the filter settling and response times: sensitivity and threshold.

Digital Filtering Sensitivity

Digital filtering sensitivity controls the stability and settling time of the scale. The sensitivity parameter can be set to heavy, medium, or light. A heavy setting will result in an output that is more stable and will settle more slowly than that of light. However, small changes in weight data (a few grads) on the scale base will not be seen as quickly.

If the difference in typical subsequent weight values on the scale will be only a few grads, use a light setting. If using a truck scale where the changes in subsequent weight values will be 100s of grads, a heavy setting will be more appropriate.

Digital Filtering Threshold

With the digital filter threshold set at zero, determine the amount of instability that is present. Convert this instability to display divisions. The number of display divisions of instability will be used to set the threshold of the digital filter. The digital filter can be set to **Off** by entering 0 in the **Filter Threshold** parameter.

Digital filtering threshold should be set for the amount of observed noise in the system. This parameter can be set in the range of 0 to 99999 display divisions. When a new sampled weight value is acquired, the adaptive filter compares the new value to the previous (filtered) output value. If the difference between the new value and the previous output value is greater than the **Filter Threshold** parameter (displayed division) the adaptive filter output is reset. The newly acquired sample value replaces the filtered output. If the difference between the new value and the previous output value is less than the **Filter Threshold** parameter, the two values are averaged together using a weighted average. The weighed average is based on the amount of the difference, time the system has been stable, and selected **Filter Sensitivity** value.

10.11 Updating the 882IS/882IS Plus CPU Firmware

The firmware for the 882IS/882IS Plus CPU can be updated using a PC. Use the following steps to update the firmware for the 882IS/882IS Plus.

1. Power off the 882IS.
2. Connect a standard USB connector to the computer and connect the USB micro end to the 882IS.
3. Power up the indicator while pressing the **F4** key on the front of the indicator.
4. Release the **F4** key after a few seconds of seeing a blank screen.
5. The Upload Disk drive window will appear on the PC.
6. Drag and drop the unzipped bin file to **UPLOAD_DISK**.
7. When the transfer is complete, the drive will go away and the 882IS/882IS Plus will reboot into the **Weigh** mode application.
8. Disconnect the USB cable.

10.12 Analog Output Calibration

See [Table 3-17 on page 43](#) for Analog Output parameters.

The following calibration procedure requires a multimeter to measure voltage or current output from the analog output module. If the option is not already installed, install it in according to the instructions included with the option.





















NOTE: The analog output must be calibrated after the indicator itself has been configured ([Section 3.0 on page 29](#)) and calibrated ([Section 4.0 on page 52](#)).



1. Enter **Configuration** mode and go to the Analog Output menu.
 - Set OUTPUT as desired for 0-10V, 0-20mA, or 4-20mA output



NOTE: The minimum calibration occurs at 0.5V and 1mA for a 0-10V and 0-20mA output respectively.

2. Connect multimeter to connector J1 on the analog output board:
 - For voltage output, connect voltmeter leads to pins 3 and 4 (-V, +V)
 - For current output, connect ammeter leads to pins 1 and 2 (-mA, +mA)
3. Adjust zero calibration:
 - Scroll to the Calibrate Zero parameter
 - Press , 000000 displays
 - Check voltage or current reading on multimeter
 - Set the parameter to match the reading from the multimeter
 - Press  or  to select the digit
 - Press  or  to increment or decrement the value
 - Press  to move to the decimal point entry
 - Press  or  to adjust the decimal point placement
 - Press  to accept the displayed value
 - **CAL** displays while the calibration is being performed.
4. Adjust span calibration:
 - Scroll to the Calibrate Span parameter
 - Press , 000000 displays
 - Set the parameter to match the reading from the multimeter
 - Press  or  to select the digit
 - Press  or  to increment or decrement the value
 - Press  to move to the decimal point entry
 - Press  or  to adjust the decimal point placement
 - Press  to accept the displayed value
 - **CAL** will be displayed while the calibration is being performed
5. Verify calibration:
 - Return to the Calibrate Zero/Calibrate Span parameter and verify that the calibration has not drifted.
 - Repeat calibration if needed
6. Return to **Weigh** mode. Analog output function can be verified using test weights.

11.0 Compliance

	EU DECLARATION OF CONFORMITY <i>EU-KONFORMITÄTSEKTLÄRUNG</i> <i>DÉCLARATION UE DE CONFORMITÉ</i>		Rice Lake Weighing Systems 230 West Coleman Street Rice Lake, Wisconsin 54868 United States of America 
	Type/Typ/Type: 882IS/882IS Plus Indicator, mb-EPS-100-240-X2 power supply, and IS6V2 battery module, IO module		
English	We declare under our sole responsibility that the products to which this declaration refers to, is in conformity with the following standard(s) or other regulations document(s).		
Deutsch	Wir erklären unter unserer alleinigen Verantwortung, dass die Produkte auf die sich diese Erklärung bezieht, den folgenden Normen und Regulierungsbestimmungen entsprechen.		
Français	Nous déclarons sous notre responsabilité que les produits auxquels se rapporte la présente déclaration, sont conformes à la/aux norme/s suivante ou au/aux document/s normatif/s suivant/s.		
EU Directive	Certificates	Standards Used / Notified Body Involvement	
2014/35/EU LVD	-	Applicable to: / Aufwendbar auf:/ Applicable a: IO module EN 62368-1:2014 +AC:2017	
2014/30/EU EMC	-	EN 61326-1:2013, EN 55011:2009+A1:2010	
2011/65/EU RoHS	-	EN 50581:2012	
2014/34/EU ATEX	FM18ATEX0047X	Applicable to: / Aufwendbar auf:/ Applicable a: Indicator, power supply, and battery module EN 60079-0:2018, EN 60079-11:2012, EN 60079-18:2015+A1:2017, EN 60529:1991 +A1:2000/A2:2013 Notified Body involved with module B and D: / Benannte Stelle, die an Modul B und D beteiligt ist: / Organisme notifié impliqué dans les modules B et D: FM Approvals Europe Ltd. - 2809	
Signature:	<u>Brandi Harder</u>		Place: <u>Rice Lake, WI USA</u>
Name:	<u>Brandi Harder</u>		Date: <u>December 19, 2022</u>
Title:	<u>Quality Manger</u>		

Form 1126 Rev. 2 01/2022

Approved by: Quality Department

UK CA

UK DECLARATION OF CONFORMITY

Rice Lake Weighing Systems
230 West Coleman Street
Rice Lake, Wisconsin 54868
United States of America

RICE LAKE
WEIGHING SYSTEMS

Type: 882IS/882IS Plus Indicator, mb-EPS-100-240-X2 power supply, and IS6V2 battery module, IO module

English We declare under our sole responsibility that the products to which this declaration refers to, is in conformity with the following standard(s) or other regulations document(s).

UK Regulations	Certificates	Standards Used / Approved Body Involvement
2016/1101 Low Voltage	-	Applicable to: / Aufwendbar auf:/ Applicable a: IO module EN 62368-1:2014 + AC:2017
2016/1091 EMC	-	EN 61326-1:2013, EN 55011:2009+A1:2010
2012/3032 RoHS	-	EN 50581:2012
2016/1107 ATEX	FM22UKEX0061X	Applicable to: / Aufwendbar auf:/ Applicable a: Indicator, power supply, and battery module EN 60079-0:2018, EN 60079-11:2012, EN 60079-18:2015+A1:2017, EN 60529:1991 +A1:2000/A2:2013 Notified Body involved with module B and D: / Benannte Stelle, die an Modul B und D beteiligt ist: / Organisme notifié impliqué dans les modules B et D: FM Approvals Ltd. - 1725

Signature: Brandi Harder

Place: Rice Lake, WI USA

Name: Brandi Harder

Date: December 19, 2022

Title: Quality Manager

12.0 Specifications

Load Cell Excitation

3.0 VDC at 87.5 Ω , 4.6 VDC at 700 Ω

Load Cell Current

34 mA (4 x 350 Ω load cells) or (8 x 700 Ω load cells)

Load Cell Cabling

Four and six-wire with remote sensing (recommended)

Analog Signal Input Range

0.6 mV/V - 4.0 mV/V

Analog Signal Sensitivity

0.2 μ V/graduation minimum

1.5 μ V/graduation recommended

Conversion Rate

60 updates/second

Resolution

10,000 displayed graduations (NTEP Certified),

1,000,000 expanded

The maximum number of allowed graduations will vary by application

Display Increments

1, 2, 5

Display

Seven-digit, seven-segment LCD display 121 x 24 dot matrix messaging area with white LED backlight

Decimal Point

Configurable with dead zeros

Unit Switching

Configurable for two units of measurement with front panel operation with conversion for tare and setpoint values

Front Panel Control Switches

882IS: Zero, Gross/Net, Tare, Print, Units Conv, Start, Stop

882IS Plus: Zero, Gross/Net, Tare, Print, Units Conv, Start, Stop, Full numeric keypad

Front Panel

Ten-button plus power button flat membrane panel

Front Panel Annunciators

Center Zero, Gross, Net, Motion, lb, kg, oz, g

Motion Band

Configurable to ± 1 or ± 3 graduations, 1 second delay (or Off)

Power Input

5.8-7.9 VDC, 100-175 mA

Maximum power consumption 0.25 watts

Operating Temperature

14°F to 104°F (-10°C to 40°C) legal

Electrical Operating Temperature

14° F to 104° F (-10° C to 40° C) legal

Rating/Material

Stainless steel IP66 enclosure

Optional Battery

Operating times: 4 x 350 Ω = 60 hrs

1 x 350 Ω = 80-100 hrs. Charging times: 8-10 hrs

Weight

6.1 lb (2.8 kg)

Warranty

One-year limited warranty

Intrinsic Safety

FM/cFM:

Class I,II,III, Division 1, Groups ABCDEFG T4

Class I, Zone 0 AEx/Ex ia IIC T4 Ga

Zone 20 AEx/Ex ia IIIC T135°C Da

Ta = -10°C to +40°C (14°F to 104°F)

ATEX/IECEX:

II 1 G Ex ia IIC T4 Ga

II 1 D Ex ia IIIC T135°C Da

Certifications and Approvals



NTEP

CC Number: 19-015

Class: III/III L n_{max} : 10 000



Measurement Canada

Approval: AM-6124C

Accuracy Class: III/IIIHD; n_{max} : 10000



OIML

File Number: R76/2006-A-NL1-21.11



FM Approved

FM18US0195X

FM18CA0092X



EU-Type Examination Certificate

FM18ATEX0047X



IECEX Certificates

IECEX FMG 18.0018X





© Rice Lake Weighing Systems Content subject to change without notice.

230 W. Coleman St. • Rice Lake, WI 54868 • USA USA: 800-472-6703 • International: +1-715-234-9171