

Healthweigh® H351-10

Class I MDR Wheelchair Scales

Models 2, 3, 7, 8

Operation Manual



© Rice Lake Weighing Systems. All rights reserved.

Rice Lake Weighing Systems® is a registered trademark of
Rice Lake Weighing Systems.

All other brand or product names within this publication are trademarks or
registered trademarks of their respective companies.

All information contained within this publication is, to the best of our knowledge, complete and
accurate at the time of publication. Rice Lake Weighing Systems reserves the right to make
changes to the technology, features, specifications and design of the equipment without notice.

The most current version of this publication, software, firmware and all other product
updates can be found on our website:

www.ricelake.com

Revision History

This section tracks and describes manual revisions for awareness of major updates.

Revision	Date	Description
A	October 3, 2023	Established revision history
B	August 13, 2024	Updated compliance and certification sections
C	November 5, 2024	Edited power supply in parts list

Table i. Revision Letter History



Technical training seminars are available through Rice Lake Weighing Systems. Course descriptions and dates can be viewed at www.ricelake.com/training or obtained by calling 715-234-9171 and asking for the training department.

Contents

1.0 Introduction	5
1.1 Disposal	6
2.0 Setup	7
2.1 Unpacking the Scale	7
2.2 Assembling the Scale	8
2.3 Transporting the Scale	9
3.0 Operation	10
3.1 Keypad	10
3.2 Display	11
3.3 Scale Operation	12
3.4 Weighing	12
3.5 BMI Procedure	12
3.6 Rechargeable Battery	13
3.7 Power and Communication Connections	14
3.8 Communication	14
3.9 Print Button	15
4.0 Maintenance	16
4.1 Cleaning	16
4.2 Replacing Batteries	16
4.3 Calibration Procedure	16
4.4 Troubleshooting	17
5.0 Specifications	18
6.0 Appendix	22



Rice Lake continually offers web-based video training on a growing selection of product-related topics at no cost. Visit www.ricelake.com/webinars

1.0 Introduction

The Healthweigh® Wheelchair Scale models are an electronic device designed to measure the weight of a wheelchair occupant who is unable to vacate their wheelchair. It may also function as a patient stand-on scale. It is designed as a floor-standing or floor-integrated platform whereby the known weight of the wheelchair is subtracted from the total measured weight to provide the weight of the wheelchair occupant. It is not designed to weight a bed/stretcher.

The scale models are very accessible due to the exceptionally wide ramps. Each scale is designed to provide accurate, reliable and repeatable weight measurements and has features that enable a fast and convenient weighing process. The scales are also designed with two heavy-duty rear wheels for easy portability. The design patented scales are multifunctional. Weight is automatically displayed. Then, after height is entered into the scale, the patient's BMI is displayed.



Manuals are available from Rice Lake Weighing Systems at www.ricelake.com/manuals

Warranty information is available at www.ricelake.com/warranties

Safety Definitions:



DANGER: Indicates an imminently hazardous situation that, if not avoided, will result in death or serious injury. Includes hazards that are exposed when guards are removed.



WARNING: Indicates a potentially hazardous situation that, if not avoided, could result in serious injury or death. Includes hazards that are exposed when guards are removed.



CAUTION: Indicates a potentially hazardous situation that, if not avoided, could result in minor or moderate injury.



IMPORTANT: Indicates information about procedures that, if not observed, could result in damage to equipment or corruption to and loss of data.

General Safety



Do not operate or work on this equipment unless this manual has been read and all instructions are understood. Failure to follow the instructions or heed the warnings could result in injury or death. Contact any Rice Lake Weighing Systems dealer for replacement manuals.



WARNING: Failure to heed could result in serious injury or death.

Do not use in the presence of flammable materials.

Operating at other voltages and frequencies than specified could damage the equipment. Use only medical approved mains adapters compliant with EN60601-1 standard.

Do not modify this equipment without authorization of the manufacturer.

Do not put this equipment next to or stacked on top of other equipment. This may result in malfunction. If such placement is unavoidable, ensure equipment is monitored regularly for correct operation.

Do not use accessories, transducers or cables other than those specified or provided by manufacturer. This could result in increased electromagnetic emissions or decreased electromagnetic immunity leading resulting in malfunction (see [Section 6.0 on page 22](#)).

Portable RF communications accessories (including peripherals such as antenna cables and external antennas) should be used no closer than 30 mm to the equipment or cables specified by the manufacturer. This may result in equipment performance degradation (see [Section 6.0 on page 22](#)).

Ensure the equipment is located in a shielded location. Failure to do so may result in performance degradation, interference with other equipment or interference with radio services.

This equipment has been tested for radiated RF immunity at selected frequencies. Using this equipment near equipment emitting other frequencies could result in improper operation (see [Section 6.0 on page 22](#)).



CAUTION: To prevent injury, never leave the person being weighed unattended while on the scale.

To prevent injury, do not transport the scale while a patient is on the scale.

Make sure no load is on the scale before transporting the scale.

Do not drop the scale or subject it to violent shocks.

The scales are for determining weight of persons in rooms intended for carrying out medical care. The scales are NOT intended to diagnose, prevent and monitor diseases. The scales are equipped with serial interface that can connect to the equipment compliant with EN60601-1 standard.

Do not use scale for dynamic weighing.

Don not leave a permanent load on the weighing plate. This can damage the scale.

Be careful to avoid shock and overloading the scale in excess of the prescribed maximum load rating (MAX.) minus any tare weight that is already present.

Never operate the scale in a hazardous location. The scale design is not explosion-proof. Attention should be paid that flammable mixture may also be formed from anesthetic means that contain oxygen or nitrous oxide (laughing gas).



IMPORTANT: For accurate weighing, the scale must be placed on a flat, stable surface.

For accurate weighing, verify proper operation according to the procedure described in this manual before each use.

If the "LO Bat" indicator activates, for accurate weighing, recharge the battery or connect the scale to an AC power source as soon as possible.

To avoid cross contamination, clean the scale plate after each weighing. Avoid direct skin contact during weighing.

Materials in the products have been tested and approved for the safe use by operator and patient.

The scale purpose is to determine weight in the course of medical practice.

Used as non-automatic scale, a person is to be positioned in the center of the scale plate. The weighing value can be read off after a stable weighing value has been obtained.

All batteries included with Healthweigh products intended for sale in the EU market are classified as 'Portable Batteries for General Use' and comply with European Battery Regulation (EU) 2023/1542.

1.1 Disposal



Product Disposal

The product must be brought to appropriate separate waste collection centers at the end of its life cycle.

Proper separate collection to recycle the product helps prevent possible negative effects on the environment and to health, and promotes the recycling of the materials. Users who dispose of the product illegally shall face administrative sanctions as provided by law.

Battery Disposal

Dispose of batteries at appropriate waste collection centers at the end of their life cycle in accordance with local laws and regulations. Batteries and rechargeable batteries may contain harmful substances that should not be disposed of in household waste. Batteries may contain harmful substances including but not limited to: cadmium (Cd), lithium (Li), mercury (Hg) or lead (Pb). Users who dispose of batteries illegally shall face administrative sanctions as provided by law.



WARNING: Risk of fire and explosion. Do not burn, crush, disassemble or short-circuit lithium batteries.

2.0 Setup

Scales must be verified to monitor weight of patients.



IMPORTANT: *The purpose of this scale is to determine weight in the course of medical practice. Weight can be read after stable value has been obtained.*



CAUTION: *Do not use scale for dynamic weighing.*

Do not leave a permanent load on the weighing plate. This can damage the scale.

Be careful to avoid shock and overloading the scale in excess of the prescribed maximum load rating (MAX) minus any tare weight that is already present.

Never operate the scale in a hazardous location.

The scale design is not explosion-proof. Flammable mixture can form from anesthetic means containing oxygen or nitrous oxide (laughing gas).

2.1 Unpacking the Scale

Visually inspect the scale to ensure all components are included in the box. The box should contain the scale, the indicator, this manual and a *Parts Inside* box.

Parts Inside Box

- 4 feet for the scale
- Medical-approved power supply with shielding and 1500 mm cable (230/120/ ACV 50/60 Hz, 9 VDC 0.5 AMP)

Parts for Assembly

No parts are required for assembly.

Tools Required for Assembly

No tools are required.

2.2 Assembling the Scale

Use the following procedure to unfold the scale:

1. Unpack scale making sure to lift and remove the scale from the packaging using only the carrying handle.
2. Assemble all four feet.

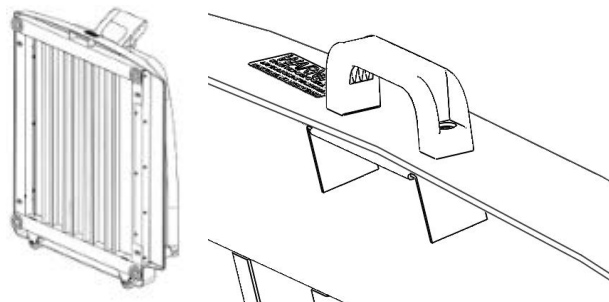

Figure 2-1. Unpacking the Scale

3. Place the scale gently on all four feet

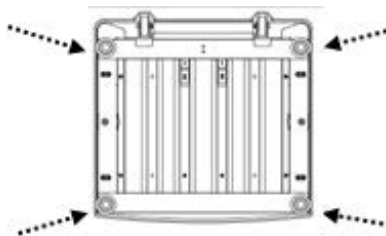

Figure 2-2. Four Feet Locations

CAUTION: Do not drop the scale. Dropping the scale might damage the scale and/or cause personal injury.

4. Stand at the rear of the scale, not on the platform.
5. Open the right-hand knob by turning it counter clockwise
6. Open the left-hand knob by turning it counter clockwise
7. Unfold the hand rail to upright position and close the right hand knob by turning it clockwise.
8. Open the left-hand knob by turning it clockwise.

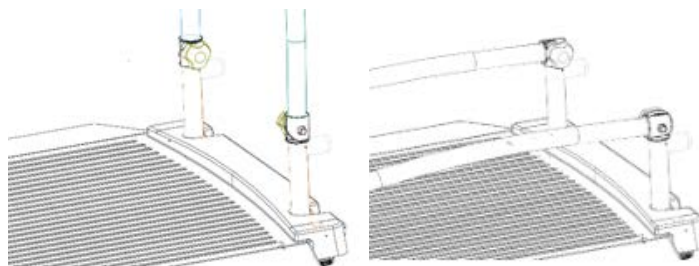

Figure 2-3. Unfolding Procedure

2.3 Transporting the Scale



CAUTION: *Ensure there is no load on the scale.*



IMPORTANT: *Do not drop the scale while repositioning. Dropping the scale might damage the scale or cause personal injury.*

The scales are equipped with wheels to transport over short distances.

1. Unplug the power adapter from the socket.
2. Return the scale to its folded position.
3. Use the handle on the front of the base to lift and position the scale onto the wheels.
4. Roll the scale to its new location. Be careful not to drop the scale. This might damage the measuring results. Use the handle for easy movement or lifting in curves.
5. Gently lay the scale on the ground.
6. Unfold the scale.
7. Plug the power adapter unit into the socket.

3.0 Operation

3.1 Keypad

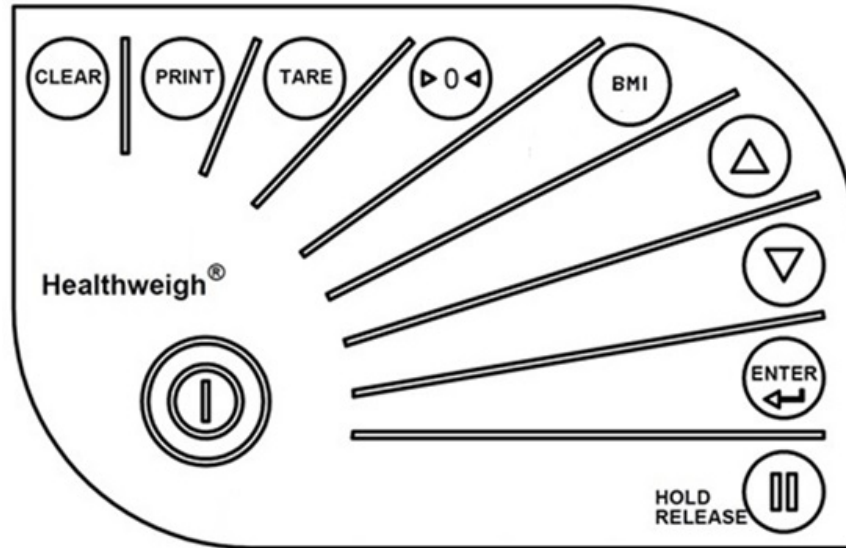

Figure 3-1. Keypad

Key	Name	Function
	On/Off	Turns the scale on or off.
	Print kg/lb	A long press will trigger a transmission of data sent out by RS232 (see Section 3.8 on page 14). When data is sent out from the port, the display flashes the word PRINT to acknowledge the data was sent. In configuration mode, a short press allows toggling between pounds and kilograms. No toggle in BMI mode.
	Zero	Zeroes the weight on the scale if the scale is stable. This function will only work if the weight on the scale is 2% or less of full capacity.
	Hold/Release	Pressing on this key while HOLD indicator is off will keep the most current weight value shown on the display along with the HOLD indicator. Pressing on this key while HOLD indicator is on will release the weight and turn off the HOLD indicator. This key is not active in BMI mode.
	BMI	Enters BMI mode. Only works if there is a locked weight shown on the display and the function is turned on in the configuration settings.
	Up/Down	Adjusts the value of the flashing digit/number.

Table 3-1. Keypad Functions



Key	Name	Function
	Clear	Causes the value to return to default (170.0 cm). In BMI final result display, pressing this key will return the scale to weighing mode.
	Enter	Accepts the value of the parameter last entered and moves to the next stage. A long press during scales start-up process will enter id display (before parameter mode).
	Tare	Weight under the limit will enter manual tare. If above the limit will enter tare function. NET and GROSS indicators are on according to the tare operation.

Table 3-1. Keypad Functions (Continued)

3.2 Display

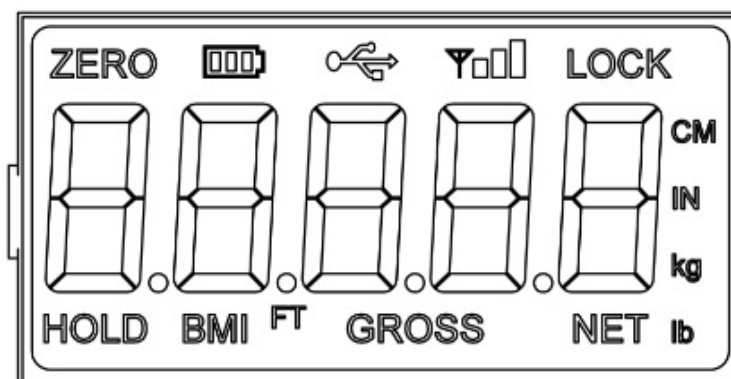

Figure 3-2. Display

Display	Description
ZERO	Scale ready for weighing
Battery Indication	Power left in the battery
USB	USB connected to the scale
LOCK	Weight is stable and the display is locked on the value
CM	Unit of length on the SI measurement system
IN	Unit of length on the Imperial and US customary measurement systems
kg	Unit of mass on the SI measurement system
lb	Unit of mass on the Imperial and US customary measurement system
NET	Indicates net weight value while tare is on
GROSS	Indicates eight value while tare is off
FT	Unit of length on the Imperial and US customary measurement system
BMI	Indicates BMI calculation is on
HOLD	Indicates weight reading will remain on screen until release (by pressing the HOLD again)
oz	Unit of mass on the Imperial and US customary measurement systems

Table 3-2. Display Descriptions

3.3 Scale Operation

1. Power the scale using either method below:
 - Connect the scale to the wall outlet with the AC adapter.
 - Ensure rechargeable batteries are installed.
2. Press the **ON/OFF** button to turn the scale on. The display will show *START*, display test, version number and finally *0.000*.
3. When the self-test function is complete, the digital display should read *00.0* and the charge indicator should be illuminated on the back.
4. The scale is ready to weigh a load.

3.4 Weighing

1. Place a weight on the scale. The digital display should blink until the weight calculation is complete.
2. Press **PRINT** to select kilograms or pounds.
3. Press **REWEIGH**. The digital display should again show the weight of the scale display.
4. To keep the weight reading, press the **HOLD** button. *HOLD* displays.
5. Remove the weight from the scale. The digital display should continue to show the weight.
6. Press the **HOLD** button. The *HOLD* indicator will disappear and the digital display should return to zero.



WARNING: *Three beeps sound upon weighing. Make sure the HOLD button is released if no beeps were sounded.*



NOTE: *If the setup procedure failed, refer to the troubleshooting section for instructions. If the problem is not resolved, refer to qualified service personnel.*

The rechargeable batteries automatically recharge when the AC adapter connects to the power source.

When the AC adapter is inserted into power source the LED lights up red. When the battery is completely recharged the LED changes from red to green.

When battery is drained, connect the scale to an AC power source for at least 8 hours to recharge the battery.

3.5 BMI Procedure

1. Person steps on scale while *ZERO* displays.



IMPORTANT: *While you are weighing, ensure that the patient doesn't touch the scale display.*

2. Weight is display (without **HOLD** annunciator turned on).
3. Press the **BMI** button to enter BMI mode. BMI and cm indicators are on and the display shows the height's default value 170.0 cm. All digits are flashing.
4. Use **UP/DOWN** buttons to adjust the entire value. Pressing once will adjust by 0.5 cm. If you hold the key down it will keep increasing or decreasing the values.
5. Press **ENTER** to accept the values. BMI value shows on the display.
6. Pressing **CLEAR** to return to weighing mode. BMI indicator is off.



NOTE: *The last height value entered is saved until the Zero is displayed or negative weight is detected. At this point, the value returns to the default value.*

Hold/Release Function

1. When the person is on the scale, press the **HOLD\RELEASE** key.
2. When the person steps off the scale the weight will remain the same.
3. The *ZERO* indicator will not turn on. At this stage the Zero button will not work. The only way to return to zero from here is to press the **HOLD\RELEASE** key once more.

Tare Function

1. When the weight is below the START parameter value press the **TARE** key.
2. The default tare value is displayed (factory programmed at 15.0 kg) while the ZERO annunciator is flashing.
3. Use the **UP/DOWN** key to adjust the value.
4. Press **ENTER** to start the tare function. NET annunciator will be turned on instead of the GROSS annunciator.

Manual Tare

1. When the weight is above the START parameter value press the **TARE** key.
2. The tare will activate with the value that was displayed at the time of the tare activation.
3. NET annunciator will be turned on instead of the GROSS annunciator.

3.6 Rechargeable Battery

The indicator is supplied with a rechargeable battery, which will be inserted at the back of the indicator. The battery is secured with a Y shaped crossbar, secured with two Philips screws to the indicator. A cover closes the indicator back.

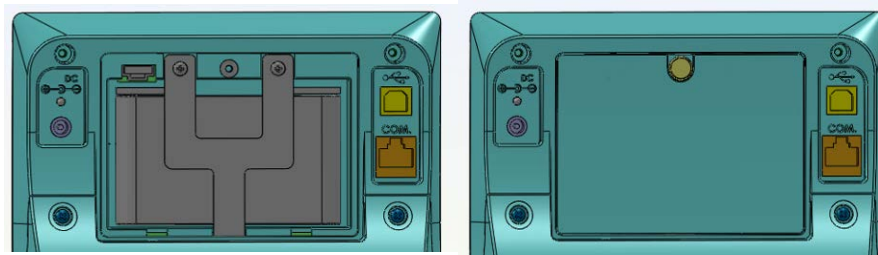

Figure 3-3. Rechargeable Battery Without Cover (left) and With Cover (right)



NOTE: A Philips head screwdriver is required for battery removal.



IMPORTANT: Dispose of batteries at appropriate waste collection centers at the end of their life cycle in accordance with local laws and regulations. Batteries and rechargeable batteries may contain harmful substances that should not be disposed of in household waste. Batteries may contain harmful substances including but not limited to: cadmium (Cd), lithium (Li), mercury (Hg) or lead (Pb). Users who dispose of batteries illegally shall face administrative sanctions as provided by law.

Battery Indicator

Battery Status	Flag Indicator
Maximum battery value	3 bars are on
Medium 2 battery value	2 bars are on
Medium 1 battery value	1 bar is on
Low battery	Battery frame
Minimum	Flashing battery frame
Critical	Scrolling <i>LOW BAT</i> and auto shutoff
No battery	Off

Table 3-3. Battery Status Indicators

- If external power supply is connected the battery flag is turned off.
- When on battery, the backlight power is reduced to 60 percent.



NOTE: Charge indicator LED will light **RED** upon connecting the power adapter. The LED will light **GREEN** when the rechargeable batteries are fully charged.

3.7 Power and Communication Connections

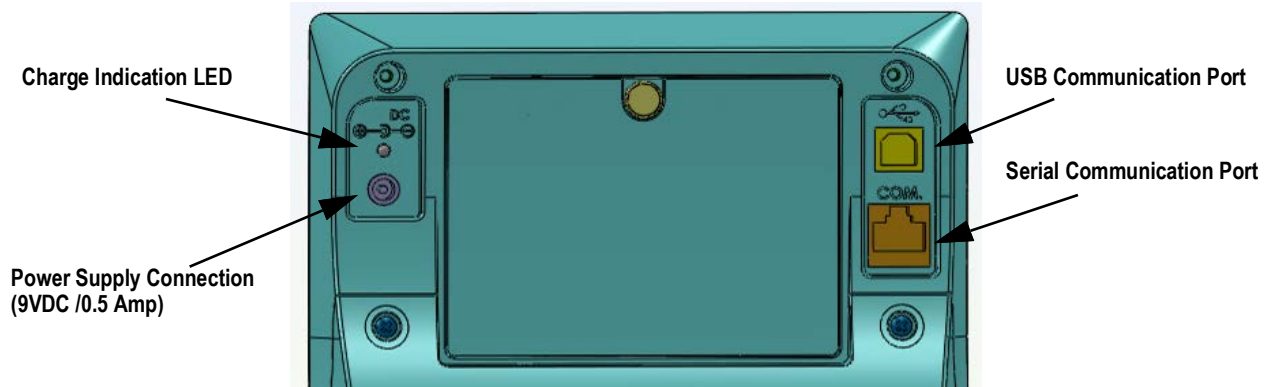

Figure 3-4. Back of Indicator

Port	Location
Serial Communication Port	An RS232 communication cable can be connected to the lower right connector (labeled COM) and then a computer.
USB Communication Port	A USB communication cable can be connected to the upper right (labeled with the USB symbol) and then a computer.
Power Supply Connection	Connect the power adapter to the left connector, (labeled with the power inlet specification). Next, connect the power adapter to the wall socket.

Table 3-4. Port Connection Locations

3.8 Communication

The scale has a communication protocol: ESC protocol. An ESC protocol is using the escape (0X1B or ASCII 27) to indicate that there is a command following. On the computer, side there must be a listener created by the vendor that will interpret this protocol. This listener must also take care of all the issues regarding data integrity, etc., to make sure that the data sent and received is valid.

Communication can be execute through either RS232 I/O port or USB I/O port. The communication parameters are:

- 9600 baud (selectable in the programming mode)
- 8 data bits
- 1 stop bit
- No parity
- No handshaking

For the USB connection, the USB driver installation will be on Windows® systems. The USB driver can be downloaded from the distributor and installation will be with the distributor's guidance. The scale support EMR protocol, for addition information contact distributor.

3.9 Print Button

A long press will send data from both RS232 and USB ports. When data is transmitted out via a port the display flashes the word PRINT to acknowledge the data was sent.

In weight mode

PATIENT WEIGHT 60.1 kg

In BMI (On calculated BMI display only)

For kg Unit of Measurement:

PATIENT WEIGHT 60.1 kg

PATIENT HEIGHT 170.0 cm

PATIENT BMI 20.8

In case of underweight or overweight, the word UNDER or OVER will be sent accordingly.

4.0 Maintenance

This section provides instructions for maintenance, cleaning and troubleshooting Healthweigh scale models.



IMPORTANT: Before first use and after periods of non-use, check the scale and batteries for proper operation and function. If the scale does not operate correctly, refer to qualified service personnel.

Check overall appearance of the scale for damage, wear and tear.

Check the batteries for damage, wear and tear. Do not use if damaged.

Inspect AC adapter for cord cracking or fraying or for broken or bent prongs.



WARNING: Maintenance operations not mentioned in this section, should be performed by qualified service personnel.

4.1 Cleaning

Proper care and cleaning is essential to ensure a long life of accurate and effective operation.



WARNING: Disconnect the scale from the AC power source before cleaning.



CAUTION: Do not immerse the scale into cleaning or other liquid solution.

Clean all external surfaces with a clean damp cloth or tissue.

4.2 Replacing Batteries

Use the following instructions to replace batteries:

1. Turn off the scale.
2. Disconnect the scale from the AC power source.
3. Open the batteries' cover and remove it; keep it for reassembly.
4. Insert rechargeable battery pack.
5. Close the battery cover
6. Turn on the scale.



IMPORTANT: Dispose of batteries at appropriate waste collection centers at the end of their life cycle in accordance with local laws and regulations. Batteries and rechargeable batteries may contain harmful substances that should not be disposed of in household waste. Batteries may contain harmful substances including but not limited to: cadmium (Cd), lithium (Li), mercury (Hg) or lead (Pb). Users who dispose of batteries illegally shall face administrative sanctions as provided by law.



WARNING: Replacing the rechargeable battery should be performed by qualified service personnel.

4.3 Calibration Procedure

Calibration to be performed by authorized personnel only



IMPORTANT: Scales with OIML Class III compliance have a seal to prevent any unauthorized person from performing calibration.

4.4 Troubleshooting

Refer to the following instructions to check and correct any failures before contacting service personnel.

Symptom	Possible Cause	Corrective Action
Scale does not turn on when using rechargeable battery	Dead battery	Connect scale to power source Replace batteries
	Faulty electrical outlet	Use a different outlet
	Bad power supply	Replace adapter
Questionable weight/ Scale does not zero	External object interfering with the scale	Check and remove all interference from the scale
	Weighing tray is not placed properly	Place the tray in its proper place
	Display did not show 0.0 kg before weighing	Remove patient, zero the scale and begin weighing process again
	Scale not placed on a stable surface	Place the scale on a stable surface and begin weighing process again
	Scale is out of calibration	Check weigh with known weight value
The display shows STOP	Load on the scale exceeds the capacity	Remove the excess weight and use the scale according to its limits
the display shows _____	Load is in under-load condition	Make sure the weighing tray is placed on the base
The display shows LO Bat	Rechargeable battery is low	Recharge the battery according to instructions

Table 4-1. Troubleshooting Checklist

Error No.	Definition	Check/Replace
SAT	A/D saturation	Check loadcell - Call technician
RTC	Error in reading Real Time Clock	Battery of real time is empty or faulty board - Call technician

Table 4-2. Error List

5.0 Specifications

H351-10-2 Capacity and Graduation

Max 300 kg, Min 2 kg, Graduation ("e") 0.1 kg

Power Requirements

Adapter 240V/100V, 50/60Hz-9 VDC, 500 mA

Use only medically approved mains adapters compliant with EN60601-1 standards.



WARNING: Use only medical approved mains adapters compliant with EN60601-1 standard.

Environmental

Operating Temperatures: 0°C to 40°C

Storage Temperatures: 0°C to 50°C

Humidity: 85%

Use in atmospheric pressure

Product Dimensions

Width: 105 cm

Depth: 100 cm

Display Height: 115 cm

Weight: 46 kg

Platform Dimensions

Width: 75 cm

Depth: 80 cm

Standing Platform Height: 6 cm



WARNING: In order to comply with EN60601-1, use UL/CE approved AC/DC adapter UE15WPC-1201255PA.

The scale is not intended for use in the presence of flammable mixtures.

H351-10-3 Capacity and Graduation

Max 300 kg, Min 2 kg, Graduation ("e") 0.1 kg

Power Requirements

Adapter 230V/120V, 50/60Hz-9 VDC, 500 mA

Use only medically approved mains adapters compliant with EN60601-1 standards.



WARNING: Use only medical approved mains adapters compliant with EN60601-1 standard.

Environmental

Operating Temperatures: 0°C to 40°C

Storage Temperatures: 0°C to 50°C

Humidity: 85%

Use in atmospheric pressure

Product Dimensions

Width: 125 cm

Depth: 100 cm

Display Height: 115 cm

Weight: 46 kg

Platform Dimensions

Width: 75 cm

Depth: 80 cm

Standing Platform Height: 6 cm



WARNING: In order to comply with EN60601-1, use UL/CE approved AC/DC adapter UE15WPC-1201255PA.

The scale is not intended for use in the presence of flammable mixtures.

H351-10-7 Capacity and Graduation

Max 300 kg, Min 2 kg, Graduation ("e") 0.1 kg

Power Requirements

Adapter 230V/120V, 50/60Hz-9 VDC, 500 mA

Use only medically approved mains adapters compliant with EN60601-1 standards.



WARNING: Use only medical approved mains adapters compliant with EN60601-1 standard.

Environmental

Operating Temperatures: 0°C to 40°C

Storage Temperatures: 0°C to 50°C

Humidity: 85%

Use in atmospheric pressure

Product Dimensions

Width: 105 cm

Depth: 100 cm

Display Height: Table or Wall Mount

Cable Length: 180 cm

Weight: 34 kg

Platform Dimensions

Width: 75 cm

Depth: 80 cm

Standing Platform Height: 6 cm



WARNING: In order to comply with EN60601-1, use UL/CE approved AC/DC adapter UE15WPC-1201255PA.

The scale is not intended for use in the presence of flammable mixtures.

H351-10-8 Capacity and Graduation

Max 300 kg, Min 2 kg, Graduation ("e") 0.1 kg

Power Requirements

Adapter 230V/120V, 50/60Hz-9 VDC, 500 mA

Use only medically approved mains adapters compliant with EN60601-1 standards.



WARNING: Use only medical approved mains adapters compliant with EN60601-1 standard.

Environmental

Operating Temperatures: 0°C to 40°C

Storage Temperatures: 0°C to 50°C

Humidity: 85%

Use in atmospheric pressure

Product Dimensions

Width: 125 cm

Depth: 100 cm

Display Height: Table or Wall Mount

Cable Length: 180 cm

Weight: 39 kg

Platform Dimensions

Width: 75 cm

Depth: 80 cm

Standing Platform Height: 6 cm



WARNING: In order to comply with EN60601-1, use UL/CE approved AC/DC adapter UE15WPC-1201255PA.

The scale is not intended for use in the presence of flammable mixtures.

6.0 Appendix

Guidance and Manufacture's Declaration – Electromagnetic Immunity

The medical scale is suitable for use in the specified electromagnetic environment and it has meets the following immunity test levels. Higher immunity levels may cause the medical scale's essential performance lost or degraded.

Phenomenon	Basic EMC Standard or Test Method	Home healthcare facility environment
Electrostatic discharge	IEC 61000-4-2:2008	+/- 8 kV contact +/- 2 kV, +/- 4 kV, +/- 8 kV, +/- 15 kV air
Radiated RF EM fields	IEC 61000-4-3:2006+A1+A2	10 V/m 80MHz-2.7GHz 80%AM at 1kHz
Proximity fields from RF wireless communications equipment	IEC 61000-4-3:2006+A1+A2	See the RF wireless communication equipment table in "Recommended minimum separation distances".
Rated power frequency magnetic fields	IEC 61000-4-8:2009	30A/m; 50 Hz or 60Hz
Electric fast transients bursts	IEC 61000-4-4:2012	Input a.c. power PORT, Input d.c. power PORT, ± 2 kV, 100kHz repetition frequency PATIENT coupling PORT, Signal input/output parts PORT: ± 1 kV, 100 kHz repetition frequency
Surges	IEC 61000-4-5:2014	Input a.c. power PORT, Input d.c. power PORT, Line to line: ± 0.5 kV, ± 1 kV Line to earth: ± 0.5 kV, ± 1 kV, ± 2 kV Signal input/output parts PORT? ± 2 kV
Conducted disturbances induced by RF fields	IEC 61000-4-6:2013	Input a.c. power PORT, Input d.c. power PORT, PATIENT coupling PORT, Signal input/output parts PORT 3 V in 0.15 MHz - 80 MHz 6 V in ISM and/or amateur radio bands between 0.15 MHz and 80 MHz 80 % AM at 1kHz
Voltage dips	IEC 61000-4-11:2004	0% U_T : 0.5 cycle at 0°, 45°, 90°, 135°, 180°, 225°, 270°, and 315° 0% U_T : 1 cycle and 70% U_T : 25/30 cycles sine phase at 0°
Voltage interruptions	IEC 61000-4-11:2004	0% U_T : 250/300 cycle
Proximity magnetic fields immunity test	IEC 61000-4-39:2017	No. Test frequency Modulation Immunity test level (A/m) 30 kHz CW 8 134.2 kHz Pulse modulation, 2.1 kHz 65 13.56 MHz Pulse modulation, 50 kHz 7.5
U_T : rated voltage(s); E.g. 25/30 cycles means 25 cycles at 50Hz or 30 cycles at 60Hz		

Guidance and Manufacture's Declaration – Electromagnetic Emissions

The medical scale is suitable for use in the specified electromagnetic environment and it has meets the following standard's emission requirements.

Phenomenon	Profession Healthcare Facility Environment	Home Healthcare Environment
Conducted and radiated RF emissions	CISPR 11, Group 1, Class B	CISPR 11, Group 1, Class B
Harmonic distortion	IEC 61000-3-2:2005+A1+A2, Class A	IEC 61000-3-2:2005+A1+A2, Class A
Voltage fluctuations and flicker	IEC 61000-3-3:2013	IEC 61000-3-3:2013

Recommended Minimum Separation Distances

Nowadays, many RF wireless equipments have being used in various healthcare locations where medical equipment and/or systems are used. When they are used in close proximity to medical equipment and/or systems, the medical equipment and/or systems' basic safety and essential performance may be affected. This medical scale has been tested with the immunity test level in the below table and meet the related requirements of IEC 60601-1-2:2014. The customer and/or user should help keep a minimum distance between RF wireless communications equipment and this medical scale as recommended below.

Test Frequency (MHz)	Band (MHz)	Service	Modulation	Maximum Power (W)	Distance (m)	Immunity Test Level (V/m)
385	380-390	TETRA 400	Pulse modulation 18Hz	1.8	0.3	27
450	430-470	GMRS 460 FRS 460	FM ± 5 kHz deviation 1 kHz sine	2	0.3	28
710	704-787	LTE Band 13, 17	Pulse modulation 217Hz	0.2	0.3	9
745						
780						
810	800-960	GSM 800/900, TETRA 800, iDEN 820, CDMA 850, LTE Band 5	Pulse modulation 18Hz	2	0.3	28
870						
930						
1720	1700-1990	GSM 1800; CDMA 1900; GSM 1900; DECT; LTE Band 1, 3, 4, 25; UMTS	Pulse modulation 217Hz	2	0.3	28
1845						
1970						
2450	2400-2570	Bluetooth, WLAN, 802.11 b/g/n, RFID 2450, LTE Band 7	Pulse modulation 217Hz	2	0.3	28
5240	5100-5800	WLAN 802.11 a/n	Pulse modulation 217Hz	0.2	0.3	9
5500						
5785						



© Rice Lake Weighing Systems Content subject to change without notice.

230 W. Coleman St. • Rice Lake, WI 54868 • USA USA: 800-472-6703 • International: +1-715-234-9171