

MSI-9600/MSI-9600HT

Hi-Torque Port-A-Weigh Plus Crane Scales

Technical Manual



© Rice Lake Weighing Systems. All rights reserved.

Rice Lake Weighing Systems® is a registered trademark of
Rice Lake Weighing Systems.

All other brand or product names within this publication are trademarks or
registered trademarks of their respective companies.

All information contained within this publication is, to the best of our knowledge, complete and
accurate at the time of publication. Rice Lake Weighing Systems reserves the right to make
changes to the technology, features, specifications and design of the equipment without notice.

The most current version of this publication, software, firmware and all other product
updates can be found on our website:

www.ricelake.com

Revision History

This section tracks and describes manual revisions for awareness of major updates.

Revision	Date	Description
A	June 15, 2023	Initial manual release with product launch

Table i. Revision Letter History



Technical training seminars are available through Rice Lake Weighing Systems. Course descriptions and dates can be viewed at www.ricelake.com/training or obtained by calling 715-234-9171 and asking for the training department.

Contents

1.0	Introduction	7
1.1	Features	7
1.2	FCC Compliance	7
1.3	Safety	8
1.4	Display	9
1.4.1	Keypad Functions	9
1.4.2	Annunciators and LEDs	10
2.0	Installation	11
2.1	Unpacking	11
2.2	Battery Pack	11
2.2.1	Battery Life	11
2.2.2	MSI-9600 Battery Charger	12
2.2.3	Battery Replacement	13
2.3	Communications Port	14
2.4	Servicing	15
2.4.1	Remove Front Casting	15
2.4.2	Reinstall Front Casting	15
2.5	Replacement Parts	16
2.5.1	MSI-9600HT Front Casting Assembly	16
2.5.2	MSI-9600HT Front Casting Assembly Components	17
2.5.3	MSI-9600HT Bulkhead Assembly	17
2.5.4	MSI-9600HT Bulkhead Assembly Components	17
2.5.5	MSI-9600HT Mid-Section Assembly	18
2.5.6	MSI-9600HT Mid-Section Assembly Components	21
2.5.7	MSI-9600HT Back Assembly	22
2.5.8	MSI-9600HT Back Assembly Components	22
3.0	Operation	23
3.1	Power	23
3.2	Zero	23
3.3	Tare	23
3.3.1	View Tare	24
3.3.2	Clear Tare	24
3.4	Function Key	24
3.4.1	Test	24
3.4.2	Total	25
3.4.3	View Total	25
3.4.4	Net / Gross	25
3.4.5	Peak Hold	25
3.4.6	Units	26
3.4.7	High Resolution Test Mode	26
3.4.8	Print	26
4.0	Setup	27
4.1	Setup Menu	27
4.2	Set Function Key	28
4.3	Auto-Off	28



Rice Lake continually offers web-based video training on a growing selection of product-related topics at no cost. Visit www.ricelake.com/webinars

4.4	Sleep	29
4.5	Display Brightness	29
4.6	Display Color	30
4.7	Setpoints	30
4.8	Total	31
4.9	Filter Setup	32
4.10	Unit	33
4.11	Battery Life	33
5.0	Calibration	34
5.1	Calibration Switch Access	34
5.2	Standard Calibration	35
5.3	Initial Calibration	36
5.4	Guidelines for Capacity and Resolution	37
5.4.1	Capacity	37
5.4.2	Resolution	37
5.5	C-Cal Calibration	38
5.6	Calibration Setup Menu	39
5.7	Auto Zero Maintenance	40
5.8	Filter	40
5.9	Gravity Compensation	41
5.9.1	Compensation by Latitudes and Elevations	41
5.9.2	Compensation by Gravity Factor	42
6.0	Communications	43
6.1	Communications Setup	43
6.2	Printer and Serial Output Setup	43
6.2.1	Standard Print Strings	44
6.2.2	Control Modes	44
6.2.3	Printer Output Setup	45
6.2.4	Custom Print Formatters	45
6.3	RF Network Setup	46
6.3.1	802.15.4 RF Network Setup	46
6.3.2	Hold Feature	48
6.4	Radio Compliance	48
6.4.1	802.15.4 (XBee 3 and XBee 3-PRO)	48
6.4.2	802.15.4 (XBee 2SC)	49
6.4.3	Wi-Fi	49
6.4.4	Bluetooth	49
6.4.5	FHSS (Frequency Hopper Spread Spectrum)	49
7.0	Optional Rugged Remote	50
7.1	Operation	50
7.1.1	Power	51
7.1.2	Zero	51
7.1.3	Tare	51
7.1.4	Programmable Function Keys	51
7.2	Conflict and Jamming Considerations	51
7.3	FCC Compliance	51



Technical training seminars are available through Rice Lake Weighing Systems. Course descriptions and dates can be viewed at www.ricelake.com/training or obtained by calling 715-234-9171 and asking for the training department.

8.0	Troubleshooting/Maintenance	52
8.1	Troubleshooting	52
8.2	Service Counters	53
9.0	Specifications	55
9.1	Dimensions	56



Rice Lake continually offers web-based video training on a growing selection of product-related topics at no cost. Visit www.ricelake.com/webinars

1.0 Introduction

This manual is intended for use by service technicians responsible for installing and servicing the MSI-9600HT Port-A-Weigh Plus and the MSI-9600 Port-A-Weigh Plus retrofit of the MSI-9300. Configurations and calibration of the scale can be accomplished using ScaleCore Connect software, RF remote control, RF remote displays, or the front panel keys. See [Section 4.0 on page 27](#) and [Section 5.0 on page 34](#) for information about setup and configuration of the MSI-9600.



Manuals are available from Rice Lake Weighing Systems at www.ricelake.com/manuals

Warranty information is available at www.ricelake.com/warranties

1.1 Features

- Automatic power off
- Automatic sleep mode
- The buttons are sealed and rated for over 1 million operations
- Precise high resolution (2500 division standard and up to 10,000 possible) 24 bit A/D conversion coupled with advanced RISC micro controller
- Five large, 1.2" (30 mm) LED digits displayed in red, green or orange
- Full digital calibration
- Can be calibrated without test weights using the **C-Cal** technology
- Selectable for kg/lb
- Automatic or manual weight totalization
- High speed Peak mode
- Eight setpoints
- ScaleCore technology
- Two service counters

1.2 FCC Compliance

United States

This equipment has been tested and found to comply with the limits for a Class A digital device, pursuant to Part 15 of the FCC Rules. These limits are designed to provide reasonable protection against harmful interference when the equipment is operated in a commercial environment. This equipment generates, uses and can radiate radio frequency energy and, if not installed and used in accordance with the instruction manual, may cause harmful interference to radio communications. Operation of this equipment in a residential area is likely to cause harmful interference in which case the user will be required to correct the interference at his own expense.

Canada

This digital apparatus does not exceed the Class A limits for radio noise emissions from digital apparatus set out in the Radio Interference Regulations of the Canadian Department of Communications.

Le présent appareil numérique n'émet pas de bruits radioélectriques dépassant les limites applicables aux appareils numériques de la Class A prescrites dans le Règlement sur le brouillage radioélectrique édicté par le ministère des Communications du Canada.

1.3 Safety

Safety Definitions:



DANGER: Indicates an imminently hazardous situation that, if not avoided, will result in death or serious injury. Includes hazards that are exposed when guards are removed.



WARNING: Indicates a potentially hazardous situation that, if not avoided, could result in serious injury or death. Includes hazards that are exposed when guards are removed.



CAUTION: Indicates a potentially hazardous situation that, if not avoided, could result in minor or moderate injury.



IMPORTANT: Indicates information about procedures that, if not observed, could result in damage to equipment or corruption to and loss of data.

General Safety



Do not operate or work on this equipment unless this manual has been read and all instructions are understood. Failure to follow the instructions or heed the warnings could result in injury or death. Contact any Rice Lake Weighing Systems dealer for replacement manuals.



WARNING

Failure to heed could result in serious injury or death.

Do not allow minors (children) or inexperienced persons to operate this unit.

Do not stand near the load being lifted as it is a potential falling hazard. Keep a safe distance.

Do not use for purposes other than weight taking or dynamic load monitoring.

Do not use any load bearing component that is worn beyond 5% of the original dimension.

Do not use the scale if any of the components of the load train are cracked, deformed or show signs of fatigue.

Do not exceed the rated load limit of the scale, rigging elements or the lifting structure.

Do not allow multi-point contact with the hook, shackle or lifting eye of the scale.

Do not allow high torque on the scale unless it is specifically designed for high torque.

Do not make alterations or modifications to the scale or associated load bearing devices.

Do not use improperly rated or sized shackles. Use only Rice Lake Weighing Systems' recommended shackles.

Do not remove or obscure warning labels.

Do not submerge to clean.

For guidelines on safe rigging and loading of overhead scales and dynameters, read the MSI Crane Scale Safety and Periodic Maintenance Manual (available at www.ricelake.com).

Keep hands, feet and loose clothing away from moving parts.

There are no user serviceable parts within the MSI-9600. Any repairs are to be performed by qualified service personnel only.

The MSI-9600 Port-A-Weigh Plus scale has a safe mechanical overload of 200% and an ultimate overload of 500%. Overloads greater than 500% could result in structural failure and dropped loads. Dropped loads could cause serious personal injury or death.

1.4 Display

The keys and display of the MSI-9600 front panel is described below.

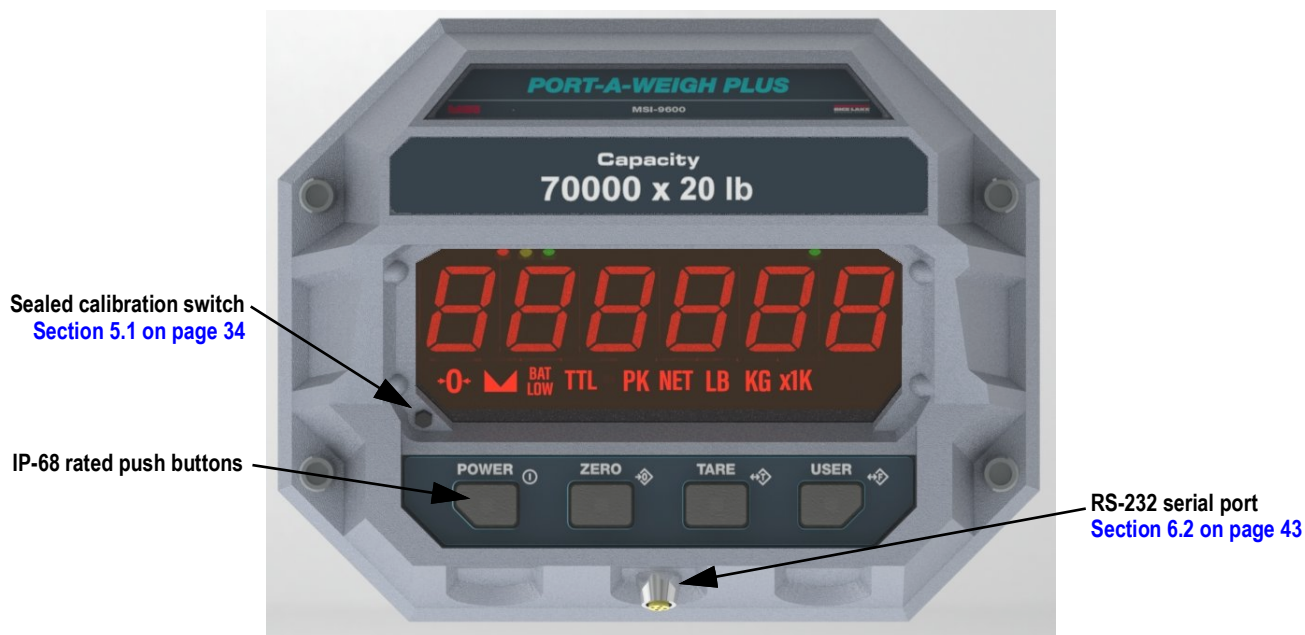

Figure 1-1. MSI-9600 Front Panel

1.4.1 Keypad Functions

The functions of the push buttons vary based on the current MSI-9600 mode.











Key		Weigh Mode	Setup Menu Navigation	Numeric Entry
	Power Key	Turns the MSI-9600 On and Off	Exits setup without saving changes; <i>CHANGE</i> displays momentarily and unit enters <i>Weigh</i> mode	Enters decimal point to the left of the blinking digit
	Zero Key	Zeros out residual weight on the scale	Saves and drops back one menu level; At the root menu level the Zero key stores the changes and returns to Weigh mode <i>STORE</i> displays briefly	Steps back one digit to change or correct the digit to the left
	Tare Key	Removes the weight of containers, trucks or carriers and places the scale in the Net Weigh mode	Functions as the Enter/Select key	Confirms blinking digit and move to the digit to the right
	User Key	Programmable to user selectable functions (Section 4.0 on page 27); This key is defaulted to the Test function	Functions as the Scroll key	Cycles blinking digit through numbers 0-9

Table 1-1. Key Functions

Example of numeric entry: Enter 2500 kg on a 5000 kg capacity scale.

- Press  two times for the leftmost blinking digit, press  to save that digit selection.
- Press  five times for the next blinking digit, press  to save that digit selection.
- Press  to save that digit selection.
- Press  to save the next digit selection. *2500* displays.

1.4.2 Annunciators and LEDs



Figure 1-2. Front Panel

Annunciator	Name	Description
→0←	Center of Zero	Indicates that the scale is zeroed and the weight is within 1/4d of zero
▲▲	Stable	Indicates that the weight has settled within the motion window (usually $\pm 1d$); When this symbol is off, the scale will not zero, tare or totalize
BAT LOW	Low Battery	Displays when 10% of battery life remains; LED blinks indicating automatic shutdown will occur
● ● ●	Setpoints	Eight user programmable setpoints for early overload warnings; Red LED = Setpoint 1, Yellow LED = Setpoint 2, Green LED = Setpoint 3
TTL	Total	Blue LED indicates the total weight displays for five seconds or less
NET	Net	Indicates the scale is in Net mode; Tare weight has been subtracted from the gross weight
PK	Peak	Indicates the scale is in Peak Hold mode
lb	LB	Red LED indicates weight display is in pounds
kg	KG	Red LED indicates weight display is in kilograms
x1K	x1000	Indicates weight display or accumulation beyond the 5 digit display limit by a multiplier of 1000; If 1K is illuminated, read the total as the displayed value multiplied by 1000
■	Acknowledge	Green LED provides feedback to the operator that incoming remote commands have been received
88888.	Display	The main display digits include six, 1.5" (30 mm) LED load display with adjustable brightness; Main display may be red, orange, or green depending on the color setting

Table 1-2. Annunciators and LEDs



WARNING: Wear appropriate hearing protection when any audible alarm is active. Not wearing appropriate hearing protection may result in hearing loss.

2.0 Installation

The MSI-9600 cast aluminum enclosure is rated at NEMA Type 4 IP 66. It hangs from a crane using properly sized shackles.



WARNING: Refer to the *Crane Scale Safety and Periodic Maintenance Manual (PN 153105)* for safe loading and rigging guidelines when installing the model MSI-9600.

Regular maintenance inspections of the lifting system should be performed to ensure safety. Pay particular attention for signs of stress on any element in the load train.

Use the appropriate interface hardware for the capacity of the scale.

- If the interface hardware does not fit properly, Rice Lake Weighing Systems can supply the MSI-9600 with oversized lifting eyes or shackle interfaces.
- If the crane hook is too large to fit in the lifting eye with single point interface, then install the scale using adaptive rigging.
- If multiple attachments are needed, use a shackle or ring to attach multiple lines to keep a single point attachment to the scale.



IMPORTANT: Using an oversized shackle or hook to interface with the MSI-9600 can cause off center loading and stress points that will reduce the life of the lifting eye or hook.

Single point attachments are necessary to ensure the safety and accuracy of the scale system.

2.1 Unpacking

When unpacking the MSI-9600, ensure that all assembly parts are accounted for. Check the MSI-9600 for any visible damage. If any parts were damaged in shipment, notify Rice Lake Weighing Systems and the shipper immediately. If the MSI-9600 must be returned, it must be properly packed with sufficient packing materials. Whenever possible, use the original carton when shipping the unit back.

2.2 Battery Pack

The MSI-9600 is powered by a 12V Sealed Lead Acid (SLA) rechargeable battery. This battery operates for up to 250 hours without a radio and 75 hours with a radio before requiring recharging, depending on LED brightness setting. Charging time for a completely discharged battery is up to eight hours. A spare battery pack is recommended to keep the MSI-9600 in continuous operation.



IMPORTANT: To obtain maximum service life from batteries, store between -4°F and 122°F (-20°C and $+50^{\circ}\text{C}$). Stored batteries should be recharged every three months. The battery is fully charged when the status indicator on the battery charger flashes.

2.2.1 Battery Life

The battery life of the MSI-9600 depends on several factors:

- LED display brightness and number of segments lit
- RF activity
- Battery age
- SLA battery condition

The MSI-9600 includes the following power saving features:

- Automatic Power Off mode — Senses no activity after the set amount of minutes and turns the scale off
- Automatic Sleep mode — Dims the display after a set amount of minutes of no scale activity

The MSI-9600 automatically turns off when the SLA battery drops to approximately 10.5V. Recharge the battery when this happens, SLA batteries benefit from frequent recharging and can be recharged when it still has available life.

Due to the maintenance discharge imposed on the battery by the MSI-9600 electronics, do not store the MSI-9600 with the battery inside. Remove the battery if it will not be used for more than two weeks.



IMPORTANT: Leaving a discharged battery in the scale, which has a maintenance battery drain, can result in a deep discharged battery which will shorten its service life.

NOTE: If the scale is in continuous use, a fully charged spare battery is recommended. Replace the drained battery as close as possible to the low battery warning.

SLA batteries that have not been deep discharged should withstand 500 to 1500 charging cycles.

Low battery warning annunciator indicates about two to four hours of use before MSI-9600 powers off.

If the MSI-9600 is not going to be used again soon, remove SLA battery to prevent deep discharge while unit is in storage.

Recycle the battery at an authorized recycling center when the average life drops to 20 hours or less.

2.2.2 MSI-9600 Battery Charger

The MSI-9600 is shipped with a battery charger designed to charge and maintain the battery. Exact charging time depends on the degree of battery discharge. A battery removed when the low battery warning first appears should take about four hours to fully charge.

DANGER: Charger is for indoor use only and should not be used in wet locations.

NOTE: When the battery is new, it might take significantly longer for the initial charge. It is recommended to charge a new battery for 24 hours. It might take several charge/discharge cycles before full capacity is reached. Deep discharged batteries also take significantly longer to charge.

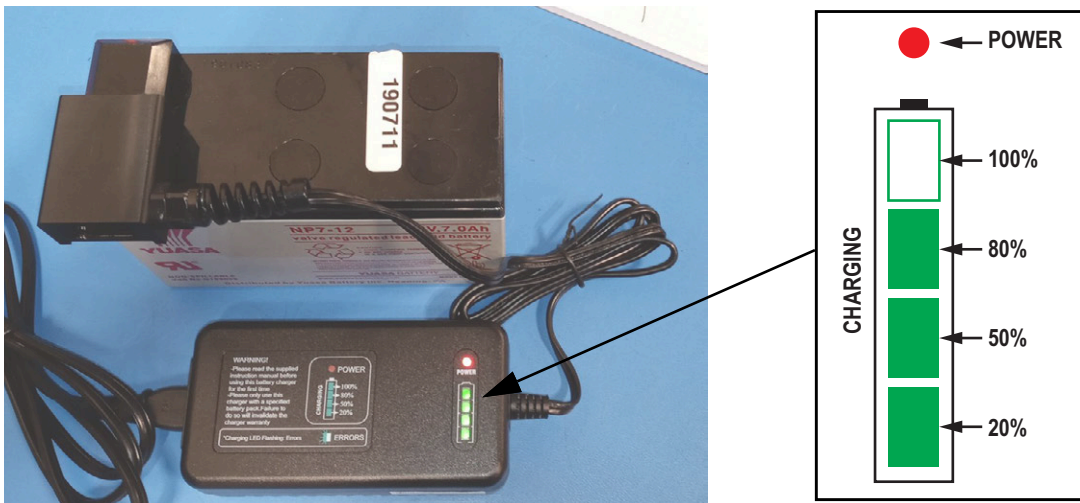

Figure 2-1. Battery Charger Connected to Battery

The battery charger illuminates annunciators as the battery charges.

1. Remove the battery from the MSI-9600 (Figure 2-2 on page 13).
2. Connect the charger assembly to the AC power supply (86-260 VAC). The power annunciator displays red.

NOTE: If the power status light fails to illuminate, check the AC power connection to ensure the jack is fully seated. AC power cords suitable for any world location are available from Rice Lake Weighing Systems.

3. Plug the polarized connector into the jacks on the battery. Charging annunciators illuminate to represent charge percentage.
4. Charge until all status annunciators fully illuminate.

When the charge cycle is complete, the battery can be left on the charger until it is needed. The charger keeps a maintenance float charge on the battery to ensure the best possible operation times.

IMPORTANT: For maximum service life from batteries, the manufacturer suggests recharging after each 20 hours of use. Continuous deep discharging reduces maximum battery life cycle.

2.2.3 Battery Replacement

1. Turn the MSI-9600 off.
2. Secure the battery cover.
3. Release the latches holding the battery cover.
4. Slowly lower the cover while holding the battery in place.
5. Remove the battery by pulling straight back.
6. Install a fully charged battery by plugging it into the exposed battery jacks.
7. Close the battery cover.
8. Reset the latches. Ensure the latches are secured and the cover is firmly in place.



Figure 2-2. Remove Battery



IMPORTANT: Periodically, inspect the battery latches for fit. Adjust the screw latch by rotating the catch on its threads to maintain a tight seat on the battery O-ring.



CAUTION: The 12V Sealed Lead Acid battery can be a dangerous falling hazard. When opening the battery hatch, hold the battery to prevent it from falling. The batteries contain lead and should be recycled when it has reached its end of life.

2.3 Communications Port

The MSI-9600 has a single communications port allowing access to the embedded ScaleCore through the terminal access mode or ScaleCore Connect. The terminal access mode is used for updating scale firmware while ScaleCore Connect can be used for calibration and configuration, backup and adjusting scale settings. This communications port is not intended for output use.

The MSI-9600 comes standard with one communications port cable wired for RS-232 following the AT standard for 9-pin serial cables (DCE). An un-terminated cable is also available for wiring the serial cable for RS-232.

Table 2-1 shows the wiring color code.

Signal	Wire Color
TxD (transmitted data)	Brown
RxD (received data)	Black
CTS (clear to send)	Gray
RTS (request to send)	White
GND (ground)	Blue
PG (protective ground)	Drain Wire

Table 2-1. RS-232 Wiring Code

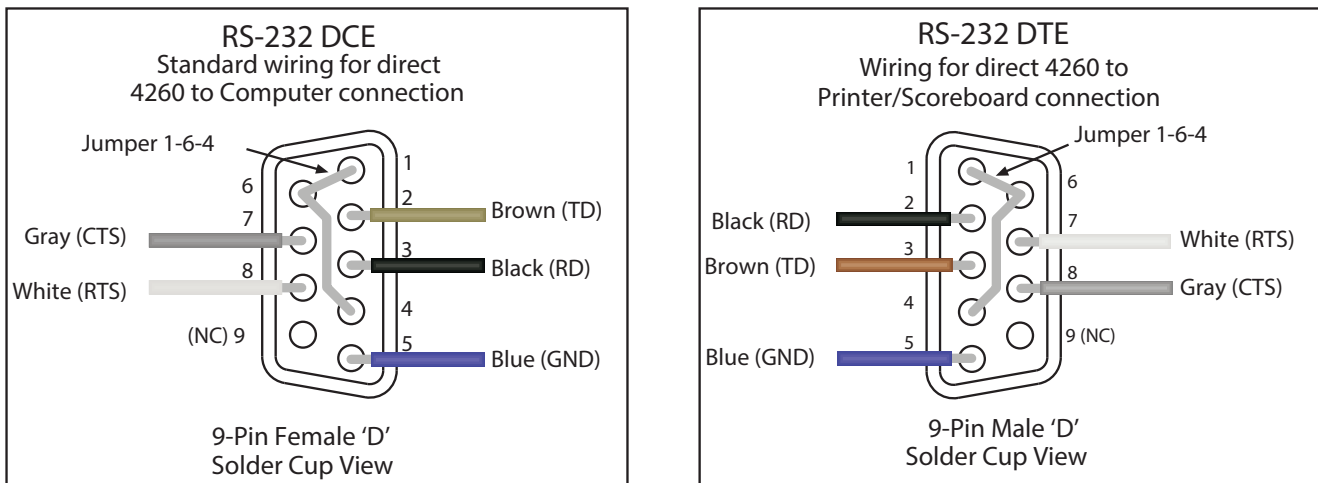

Figure 2-3. Comm Port Cable Assignments Examples

2.4 Servicing

Rice Lake Weighing System's dealer network provides both on-site and depot servicing of MSI-9600 crane scales. Please contact a local dealer or Rice Lake Weighing Systems to obtain a return material authorization (RMA). Due to the weight and size of many products, it is not always necessary to return the whole scale. Lower swivel hook assemblies and upper lifting shackles on 50k capacity models and above do not need to be returned for service or recalibration. There are no user serviceable parts inside the MSI-9600. Depot repair is performed with module and harness swaps. If the electronics are at fault, often the front casting section is all that needs to be returned.



Figure 2-4. Remove Front Casting

2.4.1 Remove Front Casting

See the following procedure to remove the front casting:

1. Remove the cap screws (x4).
2. Unplug connectors.
3. Package the front casting well for safe shipping.

2.4.2 Reinstall Front Casting

See the following procedure to reinstall the front casting:

1. Clean the front casting and bulkhead o-ring grooves with isopropyl alcohol.
2. Reconnect the load cell cables and power cables then tighten the cables.
3. While securing the o-ring, ensure the o-ring is flush with the o-ring grooves.



WARNING: Replace damaged o-rings when necessary. Damaged o-rings may break the unit seal, allowing water penetration.

4. Insert the bolts (x4) into the front casting then torque the bolts to 20–25 ft-lbs.



NOTE: Apply anti-seize compound as necessary.

2.5 Replacement Parts

2.5.1 MSI-9600HT Front Casting Assembly

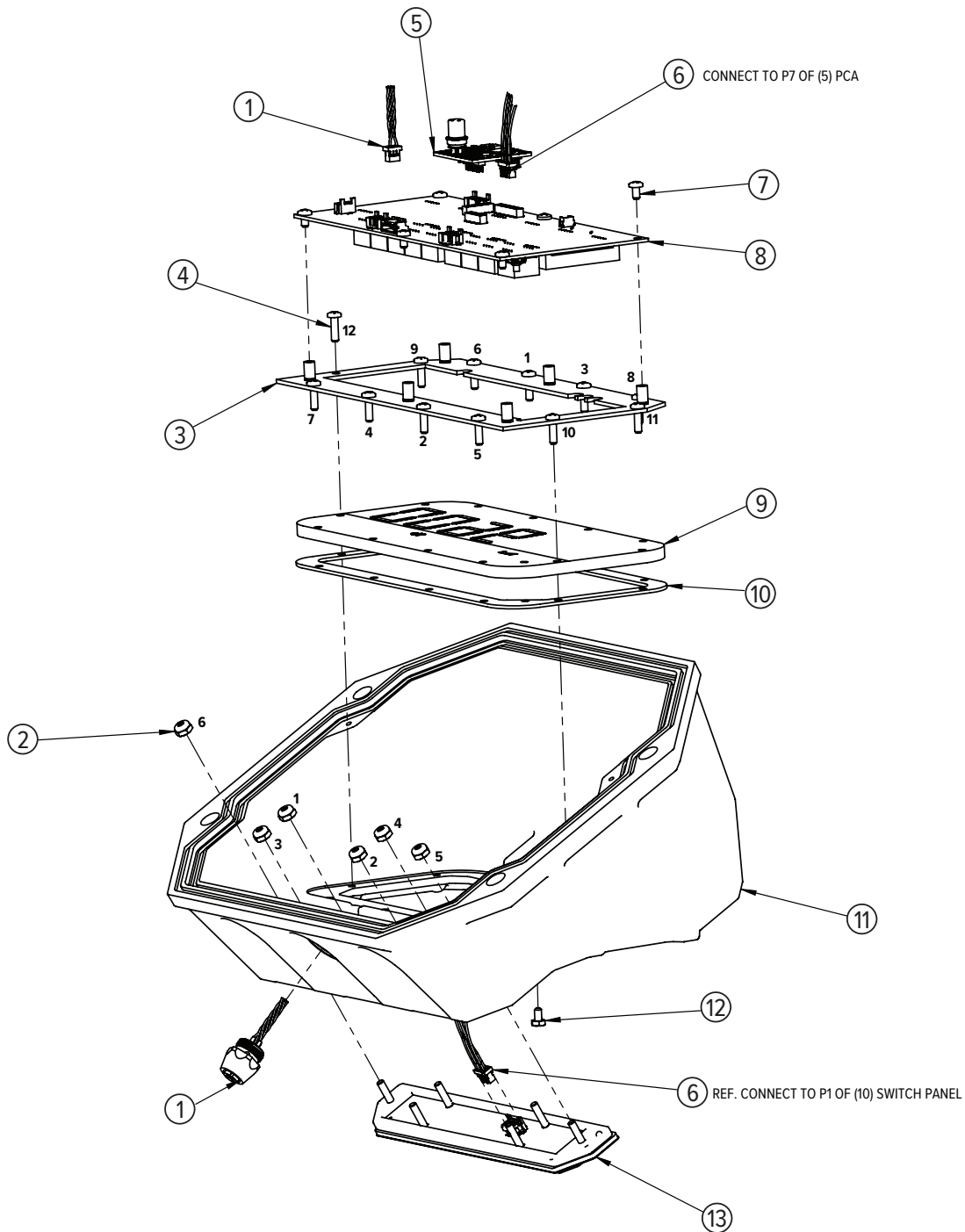

Figure 2-5. MSI-9600HT Front Casting Assembly

2.5.2 MSI-9600HT Front Casting Assembly Components

Item	Part No.	Description	Qty.
1	139449	Cable assembly, communication serial data RS-232	1
2	128445	Nut, hex 6-32 nyloc stainless steel	3
3	213965	Bracket, display PCA	1
4	216445	Screw, pan head 6-32 × 1/2 Phillips head stainless steel	12
5	153429	PCA ScaleCore3 1 channel with turck insert - controlled	1
6	214142	Cable assembly switch	1
7	144537	Screw, lkg pch pan head 6-32 × 1/4 Phillips stainless steel	6
8	212425	PCA LED display	1
9	213973	Window, ND gray	1
10	214763	Gasket, display window	1
11	213628	Casting front machined	1
12	142574	Screw hex head stainless steel blk 6-32 1/4	1
13	213678	Switch panel assembly	1

Table 2-2. MSI-9600HT Front Casting Assembly Components

2.5.3 MSI-9600HT Bulkhead Assembly

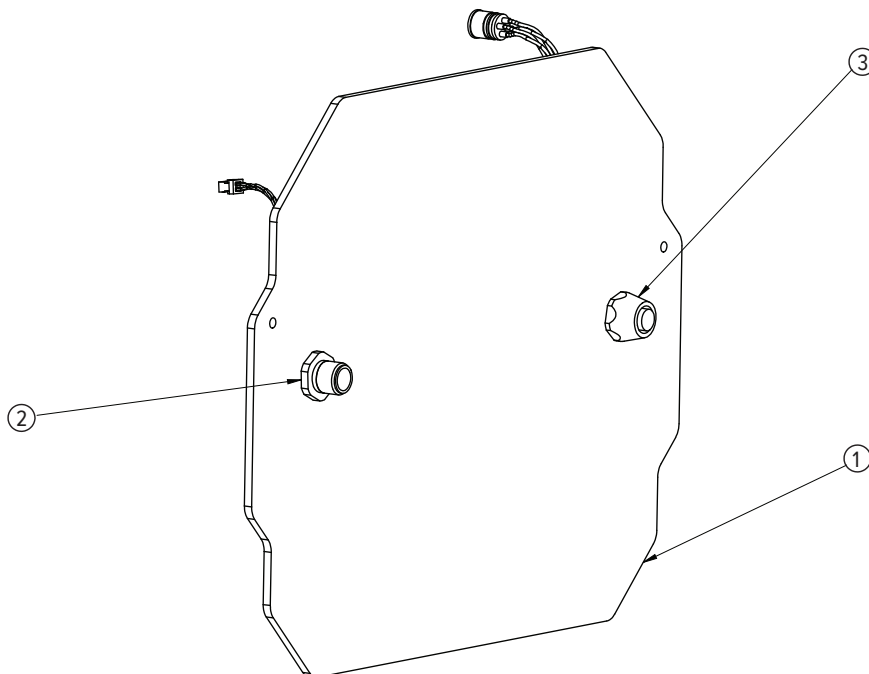

Figure 2-6. MSI-9600HT Bulkhead Assembly

2.5.4 MSI-9600HT Bulkhead Assembly Components

Item	Part No.	Description	Qty.
1	214089	Bulkhead front casting	1
2	139472	Cable Assembly, bulkhead power 12.0 in	1
3	139471	Cable Assembly, bulkhead load cell 12.0 in	1

Table 2-3. MSI-9600HT Front Casting Assembly Components

2.5.5 MSI-9600HT Mid-Section Assembly

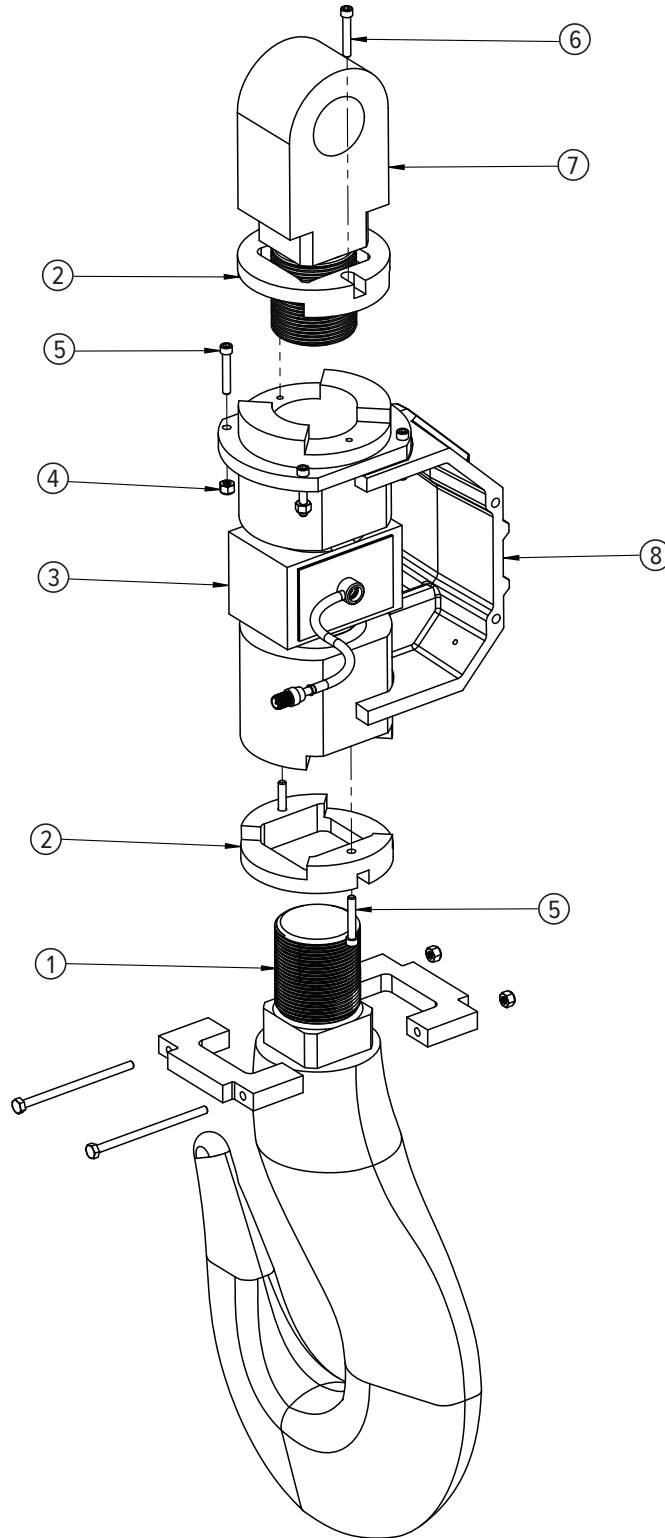

Figure 2-7. MSI-9600HT Mid-Section Assembly 10,000 lb

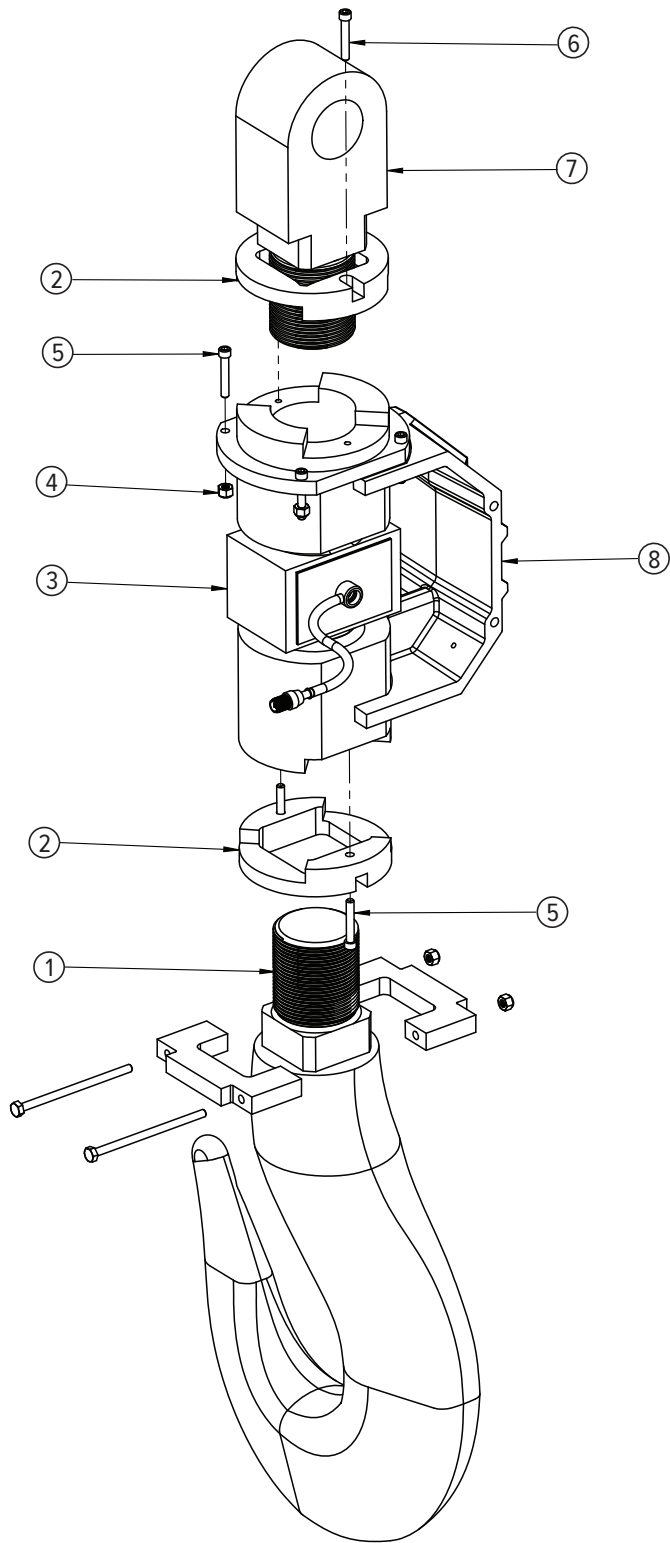

Figure 2-8. MSI-9600HT Mid-Section Assembly 30,000 lb

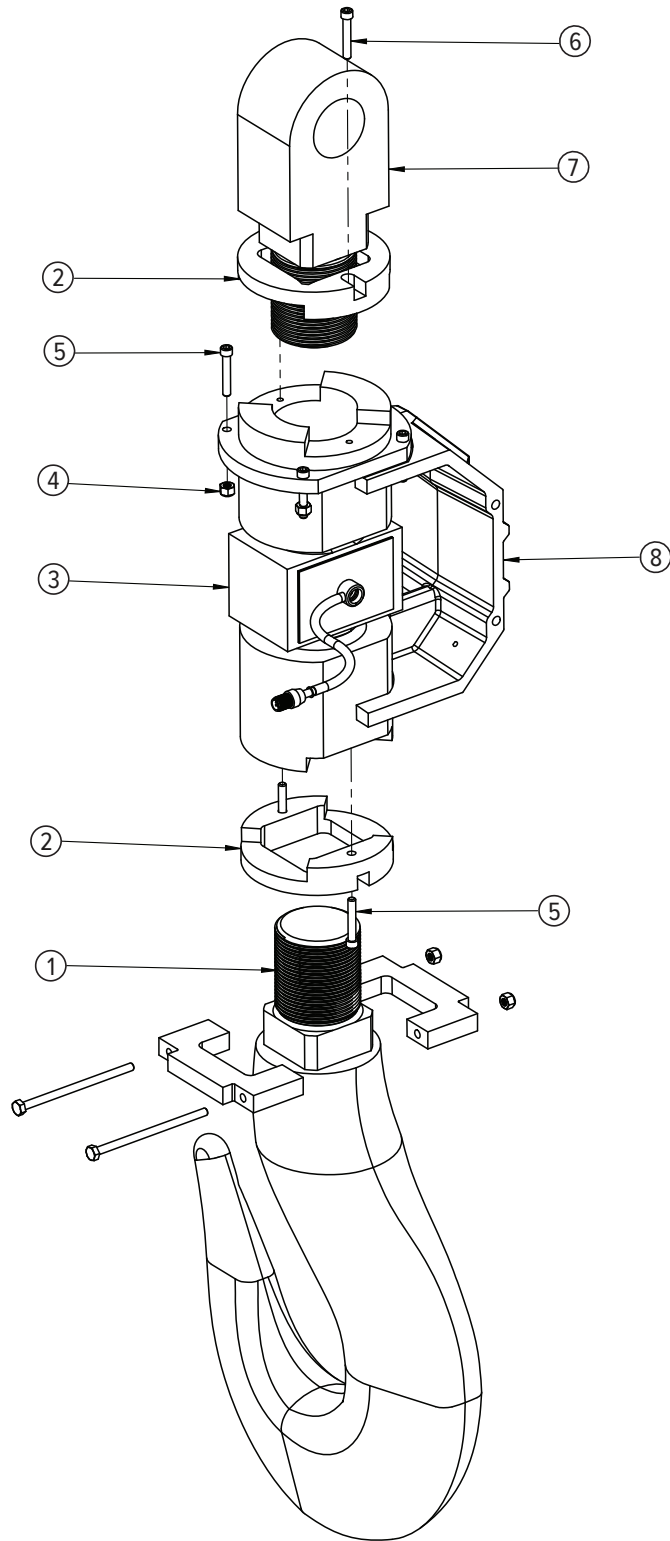

Figure 2-9. MSI-9600HT Mid-Section Assembly 70,000 lb

2.5.6 MSI-9600HT Mid-Section Assembly Components

Item	Part No.	Description	Qty.
1	138220	Hook, machined, torque	1
2	148994	Collar, torque resistant	2
3	138147	Load cell assembly, torque	1
4	109955	Screw, socket head, 1/4-20 × 3/4, stainless steel	8
5	148995	Lug, upper, torque	1
6	148964	Casting, mid-section, machined	1
Not Shown	143233	Latch, safety kit	1

Table 2-4. MSI-9600HT Mid-Section Assembly 10,000 lb Components

Item	Part No.	Description	Qty.
1	137813	Hook, machined, torque	1
2	148865	Collar, torque resistant	2
3	138145	Load cell assembly, torque	1
4	109955	Screw, socket head, 1/4-20 × 3/4, stainless steel	8
5	149037	Lug, 30K torque resistant	1
6	148963	Casting, mid-section, machined	1
Not Shown	143235	Latch, safety kit	1

Table 2-5. MSI-9600HT Mid-Section Assembly 30,000 lb Components

Item	Part No.	Description	Qty.
1	138142	Hook, machined, torque	1
2	148960	Collar, torque resistant	2
3	138146	Load cell assembly, torque	1
4	146631	Nut, hex, 1/4-20 nyloc, stainless steel	6
5	117599	Screw, socket head, 1/4-20 x 1-1/2	4
6	109955	Screw, socket head, 1/4-20 × 3/4, stainless steel	4
7	149018	Lug, 70K torque resistant	1
8	138149	Casting, mid-section, machined	1
Not Shown	142180	Latch, safety kit	1

Table 2-6. MSI-9600HT Mid-Section Assembly 70,000 lb Components

2.5.7 MSI-9600HT Back Assembly

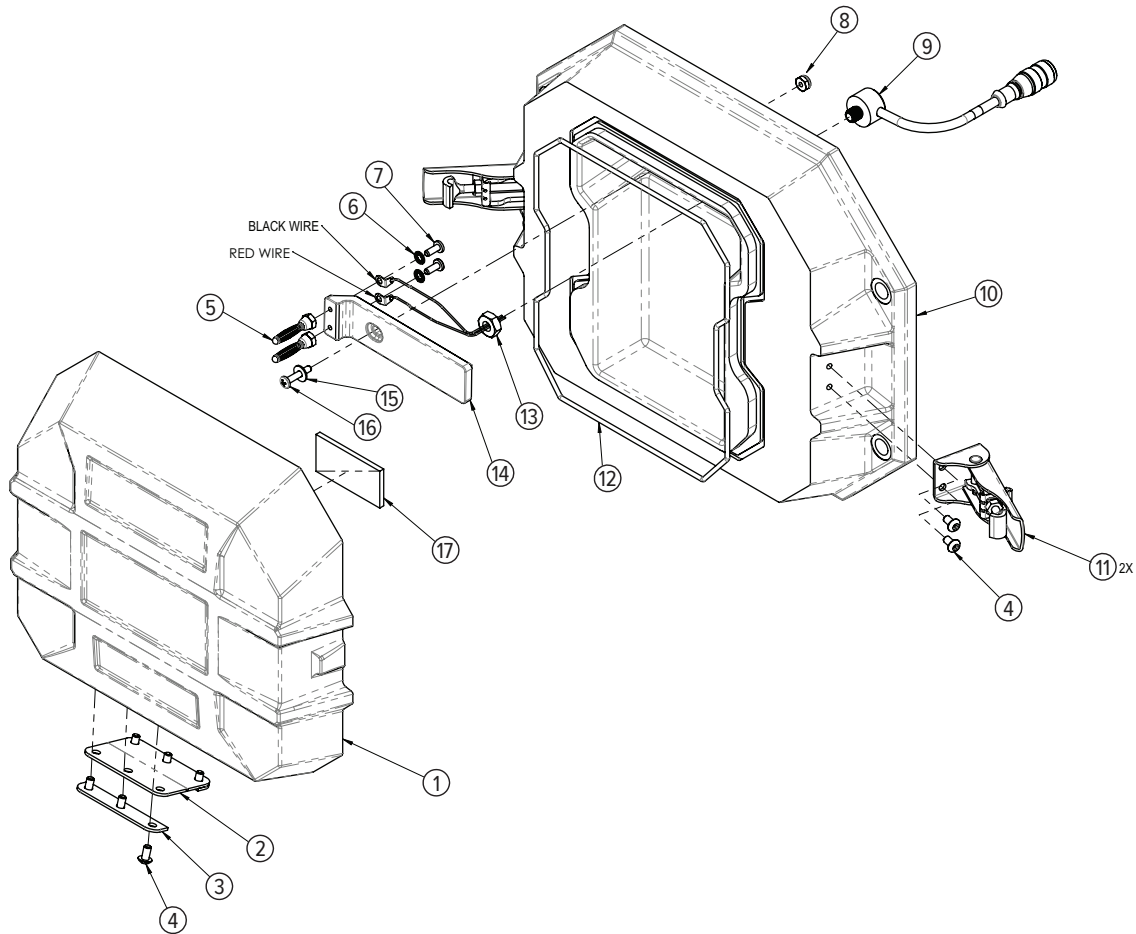

Figure 2-10. MSI-9600HT Back Assembly

2.5.8 MSI-9600HT Back Assembly Components

Item	Part No.	Description	Qty.
1	193557	Casting, rear cover, 12V, machined	1
2	149719	Fastener battery door	2
3	149718	Plate aluminum battery	4
4	213050	Screw, button head 8-32 × 5/16 stainless steel (T15) torx drive	16
5	147825	Plug banana jack	2
6	81280	Washer, lock no 6 type A	2
7	146603	Screw, pan head 6-32 × 3/8 Phillips stainless steel	2
8	146627	Nut, hex 6-32 nyloc stainless steel	1
9	214737	Cable assembly power 12 in	1
10	204844	Casting rear 12V SLA machined	1
11	145934	Latch camloc	2
12	149723	O-ring assembly batter well casting	1
13	146661	Nut, hex 5/16-18 jam stainless stell	1
14	169440	Connector block 12V battery casting intrinsically safe	1
15	55124	Washer, flat #6 cres	1
16	127036	Screw, 6-32 × 3/4 Phillips pan head 18-8 stainless steel	1
17	146640	Pad poron 2.0 × 1.0	1

Table 2-7. MSI-9600HT Back Assembly Components

3.0 Operation

The following sections describe the Weigh mode operation of the MSI-9600.

3.1 Power

The power key turns the MSI-9600 power on. While in Weigh mode, it also turns the power off.

Press  to turn on the power. The following sequence displays:

1. All LED segments light at full brightness as a display test.
2. 50Ft displays, followed by the software version number.
3. 5tRNd followed by the legal-for-trade weighing standard.
4. bRtE displays, followed by the battery voltage.
5. d.t.E5t displays, followed by the display counting from 00000 to 99999.
6. C - CRL displays, followed by the C-CAL value.
7. MSI-9600 enters Weigh mode.

While in Weigh mode, press  to turn off the power.

 **IMPORTANT:** *The scale has a maintenance battery drain. Always remove the battery if the scale will be off for an extended period of time. Leaving a discharged battery in the scale can result in a deep discharged battery which will shorten its service life.*

3.2 Zero

The zero key sets the zero reading of the scale.

Press  to remove small deviations in zero when the scale is unloaded. For zeroing (taring) package or pallet weights, see [Section 3.3](#). The zero key can be used in **GROSS** or **NET** mode.

 **NOTE:** *The backup memory in the unit stores the zero reading and retains it even if the power fails. Zeroing while in **NET** mode will zero the **GROSS** weight causing the display to show a negative tare value.*

The scale must be stable within the stable window.

The unit will only zero if  is on and there has been no activity for two seconds. If a motion ceases within the motion window in that time, the scale will zero.

The scale will accept a zero setting over the full range of the scale (NTEP enabled MSI-9600 legal for trade scale has limited zero range).



Zero settings above 4% of full scale will subtract from the overall capacity of the unit.

Example: If 100 lb on a 1,000 lb scale is zeroed, the overall capacity of the scale will reduce to 900 lb, plus the allowed over-range amount.

3.3 Tare

Tare is used to zero out a known weight, such as a packing container or pallet, and display a **NET** weight. The **TARE** function is defined as a **Tare-In** or **Tare-Out** operation.



To tare the scale:

1. Hang the empty container from the scale.
2. Press  to enter a tare value. The MSI-9600 stores the current weight as a tare value and subtracts the value of the container from the **GROSS** weight.  displays and the Weigh mode changes to **NET**.
3. Add the product to the packing container. The **NET** weight displays.

 **NOTE:** *To set a new tare, the existing tare must first be cleared. The MSI-9600 will not set a new tare over an old tare.*

3.3.1 View Tare

To view the **GROSS** weight without clearing the tare value:

1. Program  to the **NET/GROSS** function ([Section 4.2 on page 28](#)).
2. Press  to toggle between **NET** and **GROSS** values. This will only work if a tare value has been established.



NOTE: The backup memory in the MSI-9600 stores the Tare reading and can restore it even if power fails. Only positive GROSS weight readings can be tared. The STABLE annunciator must be on, indicating weight reading is stable. Setting or changing the tare has no effect on the GROSS zero setting. Taring will reduce the apparent over range of the scale. The RF Remote Control has NET/GROSS permanently available.

Example: Taring a 100 lb container on a 1,000 lb scale, the scale will overload at a NET weight of 900 lb (1,000-100) plus any additional allowed overload (usually 4% or 9d).

3.3.2 Clear Tare

To clear a saved tare value, press . The **GROSS** weight displays.



NOTE: Only positive gross weight readings can be tared.

The  must be off indicating weight reading is stable.

Setting or changing the tare has no effect on the gross zero setting.

Taring will reduce the apparent over-range of the scale.

The scale stores the tare value in non-volatile memory and is restored when power is cycled.

Example: Taring a 100 lb container on a 1000 lb scale, the scale will overload at a net weight of 900 lb (1000-100) plus any additional allowed overload (usually ~4% or 9d).

3.4 Function Key

The  key can be programmed in the setup menu ([Section 4.2 on page 28](#)) to one of the following functions. Some functions require additional programming in the setup menu to work correctly.

3.4.1 Test

When the  key is programmed to **TEST** ([Section 4.2 on page 28](#)), pressing the key prompts the scale to scroll through the following sequence and returns to Weigh mode:

1. All LED lights display momentarily at once.
2. **50F1** displays, followed by the software version number.
3. **51R1d** followed by the legal-for-trade weighing standard.
4. **6R11** displays, followed by the battery voltage.
5. **d.1E51** displays, followed by the display counting from 00000 to 99999.
6. **1 - 1R1** displays, followed by the C-CAL value.



NOTE: Other internal tests are performed and if any test fails, an error code displays. See [Section 8.1 on page 52](#) for information on the troubleshooting guide.





Automatic Scroll Test

- Press  to start the test



The unit automatically scrolls through the test sequence and returns to Weigh mode

Single Step Test Mode

To stop the automatic scroll of the test procedure, begin the automatic scroll test and press  again within two seconds to enable a single step test mode.

1. Press  to scroll through the available test functions.
2. Press  to start or display the individual tests.
3. Press  to exit individual tests.
4. Press  to exit from the test function.

3.4.2 Total

When the  key is programmed to Γ \square Γ Γ (Section 4.2 on page 28), pressing the key prompts the scale to perform the total function that has been set in the setup menu. That can be, \square Γ Γ , Γ Γ Γ , Γ Γ Γ , Γ Γ Γ , or Γ Γ Γ . For more information on these parameters and setup see Section 4.8 on page 31. If nothing has been set, nothing will happen when  is pressed.



- Press  to start the complete the total function



NOTE: The Total mode must be programmed from the Setup menus before the USER key will function.

3.4.3 View Total

When the  key is programmed to Γ Γ Γ (Section 4.2 on page 28), pressing the key prompts the scale to display total weight followed by the number of samples that have been saved.

1. Press  to display the total weight.
2. With the Total weight displayed, press  to clear.

3.4.4 Net / Gross

When the  key is programmed to Γ Γ Γ (Section 4.2 on page 28), pressing the key prompts the scale to switch the display between **NET** and **GROSS** modes. This will only work if a tare value has been established.

- Press  to toggle between NET and GROSS modes

NET weight is defined as **GROSS** weight minus a tare weight.

The operator can switch back to **GROSS** from **NET** without clearing the tare value. Only clearing or setting a new tare will change the tare value held before switching into **GROSS** mode.

3.4.5 Peak Hold

When the  key is programmed to Γ Γ Γ (Section 4.2 on page 28), pressing the key clears and re-enables the scale to only update the display when a higher weight reading is established. The peak hold function uses a high-speed mode of the A/D converter allowing it to capture transient weights at a far higher rate than typical scales.

Peak hold is cleared and re-enabled with the , that has been set to Γ Γ Γ .



NOTE: Not functional on MSI-9600 NTEP Legal for Trade scale.

3.4.6 Units

When the  key is programmed to UNITS (Section 4.2 on page 28), pressing the key changes the displayed units.

- Press  to toggle display between available units

3.4.7 High Resolution Test Mode

When the  key is programmed to HRES (Section 4.2 on page 28), pressing the key prompts the scale to toggle between normal Weigh mode and High Resolution Test mode. High Resolution Test mode displays weight at x10 resolution. While in High Resolution Test mode, all of the annunciators flash to indicate that the weight display is not set to the approved legal-for-trade resolution.

- Press  to toggle between normal and x10 resolution display

In some cases, the displayed weight in high resolution test mode will require six digits to fully display. In these cases, only the five least significant digits will be displayed. The full weight can be displayed in normal resolution by pressing the function button.

Ex: 1000.02 kg displays as 000.02 kg.



NOTE: High resolution test mode is for scale service and diagnostic use only.

Increasing the scale display resolution beyond the calibrated value does not increase scale accuracy.

High resolution test mode is not available in NTEP HB-44 legal-for-trade standard.

3.4.8 Print

When the  key is programmed to PRINT (Section 4.2 on page 28), pressing the key prompts the scale to print.

- Press  to print





NOTE: The print option must be installed and the print function must be set up in order for the print button to work. See Section 6.2 on page 43 for print setup information.

4.0 Setup

Setup menu enables configuration of the MSI-9600. This section details settings and parameters that are configured in Setup menu. For navigation and numeric entry information, see [Section 1.4.1 on page 9](#).

4.1 Setup Menu

To enter into the MSI-9600 setup menu, press  and  simultaneously.

Parameters	Choices	Description
Func	OFF	Function User Key 1 – User definable key that can be programmed to one of several functions Function User Key 2 – User definable key that can be programmed to one of several functions; Only available on the RF remote being used with the MSI-9600
	TEST	Test Display – Section 3.4.1 on page 24
	TOTAL	Total – Section 3.4.2 on page 25
	VIEW TOTAL	View Total – Function always available on the RF Remote (Section 3.4.3 on page 25)
	NET/GROSS	Net/Gross – Function always available on the RF Remote (Section 3.4.4 on page 25)
	PEAK HOLD	Peak Hold – Section 3.4.5 on page 25 Not functional on MSI-9600 NTEP Legal for Trade scale
	UNITS	Units – Section 3.4.6 on page 26
	HIGH RES	High Resolution – x10 display resolution; For testing and maintenance use only; Does not increase scale resolution or accuracy – Section 3.4.7 on page 26
	PRINT	Print – Section 3.4.8 on page 26
	AUTO OFF	OFF 15 30 45 60
SLEEP	OFF 5 15 30	Sleep – Time (in minutes) before unit will enter the sleep mode (Section 4.4 on page 29)
DISP L	LO-1 LO-2 HI-1 HI-2 AUTO	LED Display Intensity – Used to set the display brightness (Section 4.5 on page 29)
COLOR	RED	Red
	ORG	Orange
	GREEN	Green
	RD-GRN	Color changes based on passing setpoints 1 and 2; when selected, if setpoint 2 trips, the display color changes to orange; when setpoint 1 trips, the display color changes to red (Section 4.6 on page 30)
SETPOINT 1-8	OFF GREEN LESS	Setpoint 1 to 8 – Used for warnings or process control (Section 4.7 on page 30)
TOTAL	OFF TOTAL ON ALARM ALARM ALARM	Total Mode – accumulation of multiple weighments (Section 4.8 on page 31)
FILTER	OFF LO HI-1	Weight Filter – allows the scale to adjust to situations where there may be movement (Section 4.9 on page 32)
UNITS	See Annunciator	Weight Units – toggle units between pounds and kilograms; Function not available or non-functional in 1Unit mode (Section 4.10 on page 33)
BATTERY	STANDARD LONG	Battery Life – sets the options for standard or extended battery life (Section 4.11 on page 33)







Table 4-1. Function Key Settings



4.2 Set Function Key

The MSI-9600 has one user definable key  on the front panel, that can be programmed to one of several functions. The additional function key is available on the RF remote control being used.

 **NOTE:** If a function key does not work, it is probably because the MSI-9600 is not set up to support the key. For example, if the Function Key is set for TOTAL, the TOTAL mode must also be set up in the Setup menu.

To set the function key use the following steps:







1. Press and hold  and . FUNC displays.
2. Press . The current user key function displays.
3. Press  to scroll through the available functions.
4. Press  when the desired function displays. R- OFF displays.
5. Press . SLEEP displays, the unit exits setup and stores the settings.

 **NOTE:** Press  at any time to cancel the procedure.

4.3 Auto-Off

The **Auto-Off** feature prolongs the battery life by automatically powering off the unit if no buttons are pressed and there is no change in the load exceeding 10 d for the time period, in minutes, set by the user. When a button is pressed or the detected load is in motion exceeding 10 d, the time limit is reset.

When disabled, the unit will only turn off by pressing , or if the battery dies. To set the **Auto-Off** function:







1. Press and hold  and . FUNC displays.
2. Press  to scroll to R- OFF.
3. Press . The current auto off time displays.
4. Press  to scroll through the available times.
5. Press  when the desired time displays. SLEEP displays.
6. Press  to exit setup and store the settings.



 **NOTE:** Press  at any time to cancel the procedure.

4.4 Sleep

The sleep parameter reduces power consumption by automatically turning off the display during periods of inactivity. While in the sleep mode, the green acknowledge annunciator will blink at a one second rate to indicate the unit is in sleep mode. To wake up the unit, either a button must be pushed (front panel or RF remote) or the weight must change by 5 d or more.

 **NOTE:** Sleep must be set to less time than the Auto-Off timer.

1. Press and hold  and . **FUNC 1** displays.
2. Press the  to scroll to the **SLEEP** function.
3. Press . The current **SLEEP** time displays.
4. Press the  to scroll through the available times.
5. Press  when the desired time displays. **d 15PL** displays.
6. Press  to exit setup and store the settings.





 **NOTE:** Press  at any time to cancel the procedure.

4.5 Display Brightness



The **Display** setup menu is used to set the display brightness. There are four fixed brightness settings and one automatic light sensing brightness setting.



Auto setting automatically detects the ambient light and adjusts the brightness of the display accordingly.

There are four fixed brightness settings, **LO-1**, **LO-2**, **HI-1** and **HI-2**. Lower brightness settings increase battery life.

1. Press and hold  and . **FUNC 1** displays.
2. Press the  to scroll to the **d 15PL**.
3. Press . The current setting displays.
4. Press the  to scroll through the available settings.

 **NOTE:** The display brightness changes when each setting displays.

5. Press  when the desired setting displays. **[COLOR]** displays.
6. Press  to exit setup and store the settings.

 **NOTE:** Press  at any time to cancel the procedure.

4.6 Display Color

The MSI-9600 display supports four color schemes. Three of the color schemes display a steady color. The fourth, *red-9n*, changes the color of the display when setpoints 1 and 2 are tripped (Section 4.7). This is useful in warning of possible overload conditions..

Color	Description
<i>red</i>	Steady red
<i>orange</i>	Steady orange
<i>green</i>	Steady green
<i>red-9n</i>	Variable Color — Display color changes based on setpoints 1 and 2; Green — No setpoints have been tripped Orange — Setpoint 2 tripped, setpoint 1 not tripped Red — Setpoint 1 tripped

Table 4-2. Display Colors

4.7 Setpoints

The MSI-9600 supports eight setpoints. Common uses of setpoints are for warnings or process control. It comes standard with LED outputs for a triggered set point.











Figure 4-1. Setpoint LEDs



The MSI-9600 has an audible output option that is triggered by Setpoint 1. Contact Rice Lake Weighing Systems for other setpoint output options.

Setpoint	Description
Setpoint Mode	
<i>GREAT</i>	Indicates the setpoint will trigger when the weight exceeds a set value
<i>LESS</i>	Indicates the setpoint will trigger when the weight is less than a set value
Setpoint Weight Type	
<i>NETGR</i>	responds to net or gross weight
<i>GROSS</i>	responds to gross weight regardless of the display
<i>TOTAL</i>	responds to the totaled weight
<i>T-CNT</i>	responds to the total count (number of samples)
<i>LF-CNT</i>	responds to the number of times the weight has exceeded 25% of capacity



Table 4-3. Available Setpoint Settings



To set the setpoint:

1. Press and hold  and . *FUNC 1* displays.
2. Press  to scroll to the desired setpoint (*SETPt 1 - 8*).
3. Press . The current *SETPt* mode displays.
4. Press  to scroll to the setpoint mode desired.
5. Press . The current *SETPt* weight type displays.
6. Press  to scroll to the desired weight type.
7. Press . The current setpoint weight value displays.

8. Press . The first digit will blink.
9. Press  to scroll to the desired number.
10. Press . The second digit blinks.
11. Repeat [Step 8](#) – [Step 10](#) until the desired value displays.

 **NOTE:** To enter a decimal point, press  while the digit is blinking. To correct a digit, press  to step back.

12. Press . The value will stop blinking and the next setup menu item displays.
13. Repeat [Step 2](#) – [Step 12](#) to set all the setpoints to be used.
14. Press  to exit setup and store the settings.

 **NOTE:** Press  at any time to cancel the procedure.

4.8 Total

Total function is used to accumulate multiple weighments so that gross and net readings can be added into the same total number. There are four modes of totalizing: one manual mode and three auto modes.

The manual total mode and three auto total modes all require that the weight on the scale return below 0.5% (relative to full scale) of **GROSS ZERO** or **NET ZERO** before the next weighment can be added. Applied weight must be $\geq 1\%$ of full scale above **GROSS ZERO** or **NET ZERO** before it can be totaled.

Manual Total Mode

The manual mode requires the **TOTAL** key be pressed with the weight on the scale. The weight will be added to the previously accumulated value. This assures that a weight on the scale is only added to the total once.

The **USER** key under the **MANUAL TOTAL** mode functions in this manner:



- If weight is greater than 1% of capacity and has not been totaled – Pushing the **USER** key adds the current weight to the TOTAL weight. The displayed weight blinks to indicate the weight was accepted. The TOTAL annunciator lights and the Total weight display for five seconds and then the number of samples displays for two seconds.
- If current Weight has been totaled – Pushing the **USER** key displays the Total weight for five seconds (View Total) without changing the Total value. The TOTAL annunciator illuminates during the TOTAL weight display. After five seconds of Total Weight display, the number of samples displays for two seconds.
- If weight is less than 1% of capacity – The **USER** key functions as View Total only and functions as View Total until the 1% threshold is exceeded to allow the next addition to the total value.

Auto Total Modes

The **USER** key under the **AUTO TOTAL** mode functions as Auto Total On / Auto Total Off.











The Auto mode has three variations which are programmed in the Setup menu:

- **A. L o A d – AutoLoad** ensures any settled load above the threshold will be automatically totaled. The scale must fall below threshold before the next total is allowed.
- **A. L A S T – AutoLast** mode takes the last settled weight to auto total with. The total occurs only once the scale goes below the threshold. This allows the load to be adjusted without a total occurring. Once the load is removed, the scale uses the last settled reading for total.
- **A. H i G H – AutoHigh** uses the highest settled reading. This is useful for loads that can't be removed all at once.

 **NOTE:** Total mode will not function while the scale is in motion, make sure  is on. If the system fails to achieve stable readings, increase the filter setting or increase the size of the scale division (d) in the Init Cal procedure.

NOTE: If 1K is illuminated, read the total as the displayed value multiplied by 1000.











Set Total Mode

1. If the unit is turned off, press and hold  then press .
If the unit is on, press  and  simultaneously. *Func 1* displays.
2. Using the , scroll to *TOTAL*.
3. Press . The currently saved total mode displays.
4. Press  to scroll through the choices.
5. With choice displayed, press  to select. *Filter* displays.
6. Press  to save and exit to weighing mode or press  to continue to another setup menu item.









4.9 Filter Setup

Changing the filter settings allows the scale to adjust to situations where there is a lot a movement in the structure. If the reading is not stable, it can often be improved by increasing the filter setting. Settling time will be longer as the filter setting is increased. However, the MSI-9600 employs algorithms that speed up large weight changes while still controlling vibration even with high filter settings.











Use the following steps to set up filtering.

1. If the unit is turned off, press and hold  then press .
If the unit is on, press  and  simultaneously. *Func 1* displays.
2. Using the , scroll to *Filter*.
3. Press . The currently saved filter mode displays.
4. Press  to scroll through the choices.
5. With choice displayed, press  to select. *Unit* displays.
6. Press  to save and exit to weighing mode or press  to continue to another setup menu item.

4.10 Unit

1. Press and hold  and . *FUNC 1* displays.
If the unit is on, press  and  simultaneously. *FUNC 1* displays.
2. Press  to scroll to *Unit*.
3. Press  to enter *Unit*.
4. Press  to toggle between lb and kg.
5. With the desired choice displayed, press  to select.
6. Press  to save and exit to weighing mode.

4.11 Battery Life

1. If the unit is turned off, press and hold  then press .
If the unit is on, press  and  simultaneously. *FUNC 1* displays.
2. Using the , scroll to *B. LIFE*.
3. Press . The currently saved battery life setting displays.
4. Press  to toggle between the choices.
5. With choice displayed, press  to select. *FUNC 1* displays.
6. Press  to save and exit to weighing mode or press  to continue to another setup menu item.

5.0 Calibration

The MSI-9600 is calibrated using standard weights. The weight used to calibrate, must be at least 15% of full capacity in order to achieve rated accuracy. For example, use at least a 750 kg test weight to calibrate a 5000 kg capacity scale. Although a single span point is usually adequate for rated accuracy, the MSI-9600 supports Multi-Point calibration with up to four span points plus zero.

There are three kinds of calibration:

- **Standard Calibration** – Used for maintenance and routine calibration. (Section 5.2 on page 35)
- **Initial Calibration** – Used to set up both the capacity and resolution (d) of the scale. It differs from Standard Calibration only in the initial steps. The initial calibration is performed after a calibration reset which completely erases the calibration and setup memory. (Section 5.3 on page 36)
- **C-Cal** – Calculated Constant Calibration. Used when test weights are not available. To use C-Cal, a previously generated C-Cal number must be known. (Section 5.5 on page 38)

5.1 Calibration Switch Access

Use the following steps to access the calibration switch on the MSI-9600 if calibrating the unit using either the standard calibration or the C-Cal calibration.

1. Remove the hex seal screw from the MSI-9600.





Figure 5-1. Calibration Switch Seal Screw

2. Using a small screwdriver, press the Cal switch located behind the hex seal screw. $\square RL$ displays.

5.2 Standard Calibration

Use the following steps to calibrate the MSI-9600 using the standard calibration procedure.

1. Press Cal switch to initiate Calibration. ([Section 5.1 on page 34](#))
2. Press , *UnLd* displays.
3. Press  when the scale becomes stable, a blinking *0* displays. If the scale is in range of zero, *PASS* displays, then *LoRd 1* displays.
4. Load the scale with a test weight.







NOTE: For a single span point calibration, a test weight of more than 15% of capacity or more is recommended

5. Press , The current capacity flashes on the display.







NOTE: If loading the scale with the capacity weight, skip to [Step 8](#).

6. Press , to enter the value of the test weight. The far left digit blinks indicating a number should be entered.
7. Press  to scroll the numbers and  to enter each digit as in [Section 1.4.1 on page 9](#).
8. Press , to save the weight entry. If the cal value is within limits, *PASS* displays briefly then *LoRd 2*.









NOTE: Display displays *LoRd 3* and *LoRd 4* after the second and third cal values have been entered. After the fourth cal value has been entered, *CRd 1* displays. Continue to .

9. If additional cal points are needed, press , and repeat steps [Step 4](#) through [Step 8](#) for each additional cal point.
10. When all cal points have been recorded, press , *CRd 1* displays to indicate that the calibration was successful.
11. Press , *CRd 1* briefly displays followed by the C-Cal number.
12. Press , to store the calibration. *SEtUP* displays.
13. Press , to exit the calibration menu. Scale returns to Weigh mode.
14. Replace the hex seal screw that was removed in [Section 5.1 on page 34](#).

5.3 Initial Calibration







Use this procedure only if the capacity and count-by (d) needs to be modified. The initial steps of the initial calibration will totally erase user setup as well as any previous calibration.

Use the following steps to calibrate the MSI-9600 using the initial calibration procedure.

1. Turn the MSI-9600 off.
2. Remove the hex seal screw using the steps in [Section 5.1 on page 34](#).
3. Press the **Cal** switch and the **Power** switch on the unit simultaneously. *rESEt* displays.
4. Press  to reset the calibration constants. *SurEP* displays.
5. Press  to confirm. *FL* displays.
6. Press  to start the configuration. *Unit* displays.
7. Press  to choose unit.
8. Press  to toggle between lb and kg.
9. Press  to confirm unit. *RP* displays.
10. Press  to set scale capacity. Initial value of *10000* displays.



NOTE: 10000 is the initial default value. Capacity should be set no higher than the load cell rated capacity.

11. Press  to change the capacity. the first digit on the display blinks.
12. Press  to scroll the numbers and  to enter each digit as in [Section 1.4.1 on page 9](#).
13. Press  to store the capacity value. *d* displays.
14. Press  to choose scale divisions.
15. Press  to scroll through the recommended scale divisions.
16. Press  to select scale division. *Unit d* displays.
17. Calibrate the MSI-9600 as in [Section 5.2 on page 35](#) beginning with [Step 2](#).

5.4 Guidelines for Capacity and Resolution

Capacity and resolution are set in the initial calibration of the MSI-9600.

5.4.1 Capacity

Setting capacity is determined primarily by the capability of the load cell.



NOTE: Never set the capacity of the scale higher than the rating of the load cell.

It is acceptable to set lower capacities to better match the crane the MSI-9600 is used on. For example, if the hoist is rated for 9000 lb, use an MSI-9600 with 10,000 lb capacity and reset the capacity to 9000 lb so that the scale will indicate overload at 9000 lb instead of 10000 lb. De-rating as much as 50% of the capacity is usually acceptable, but the scale may be less stable if the 'd' is decreased.

Due to kg to lb conversions, the capacity of all MSI-9600 systems is rated approximately 20% higher than the rated capacity in pounds. This is to allow the kg capacity to be exactly 1/2 the number of the pound capacity.

5.4.2 Resolution

Due to Legal-for-Trade requirements and general scale design criteria, the weight must be stable for certain features to work:

- ZERO – Weight must be stable to be zeroed
- TARE – Weight must be stable to be tared
- TOTAL – Weight must be stable to be added to the total registers

If the MSI-9600 does not become stable under standard operation, it is recommended that the resolution be reduced and/or filtering increased. Some improvement in stability can be achieved by increasing the filtering ([Section 4.9 on page 32](#)).

Resolution is reduced by increasing the "d" value during initial calibration ([Section 5.3 on page 36](#)). Rice Lake Weighing Systems recommends that the resolution is kept in the 1:2000 to 1:3000 range. Never program the resolution greater than needed.

The third way to increase stability is to increase the **Motion Window**. The MSI-9600 defaults to $\pm 1d$ as a motion window. It can be changed at Rice Lake Weighing Systems to a higher value if desired. Often $\pm 3d$ is chosen for bridge cranes as they tend to have a lot of bounce to them. This of course carries an accuracy penalty adding $\pm 3d$ to the total accuracy of the scale if the zero or tare operation happens to capture the weight in a valley or peak.



NOTE: Motion Window can only be changed by Rice Lake Weighing Systems.

5.5 C-Cal Calibration











When adequate test weights are not available, the MSI-9600 can be calibrated using a programmed constant calibration number which is referred to as C-Cal. To perform C-Cal, a C-Cal number must be known from a previous calibration. MSI supplies replacement load cells for the MSI-9600 with the C-Cal value stamped on the serial number label. When a calibration is performed with test weights, a new C-Cal is generated. C-Cal can be used when the electronics are replaced to get an approximate calibration that may be suitable for non L-F-T applications.



IMPORTANT: The C-Cal number must be known prior to starting this procedure. For a MSI-9600 with its original load cell, MSI prints this number on the calibration record and the serial number tag.

C-Calibration can be done if the electronics are replaced or a new load cell is installed. C-Cal reduces the absolute accuracy of the system and is intended for non-critical use only. If a system was originally multi-point calibrated, the C-CAL calibration will erase the additional span points, as C-Cal is only a two point calibration (zero and span at 10% of capacity).

Use the following steps to perform a C-Cal calibration.

1. Remove the hex seal screw from the MSI-9600 and enter the calibration menu using the steps from [Section 5.1 on page 34](#).
2. Press  to scroll to the C-Cal menu selection. $\bar{C} - \bar{C}RL$ displays.
3. Press  to start the C-Cal procedure. $\bar{U}nL d$ displays.
4. Remove all weight from hook.
5. Press  to set the zero calibration point. A flashing $\bar{0}$ displays.
6. If the zero is in range, $PASS$ displays, followed by $\bar{C}RLP$
7. Press  to confirm.
8. Press  to enter the C-Cal value. The first digit on the display blinks.
9. Press  to scroll the numbers and  to enter each digit as in [Section 1.4.1 on page 9](#).
10. Press  to save the C-Cal value. $PASS$ displays, followed by $\bar{C}RL d$.
11. Press  to exit C-Cal setup menu and
12. Press  again to store the calibration and return to the scale operation. $StoRE$ displays.

5.6 Calibration Setup Menu

Remove the hex seal screw from the MSI-9600 and enter the calibration menu using the steps from [Section 5.1 on page 34](#).

The Calibration Setup menu contains two additional items beyond Calibration:







- Legal Standard menu
- Auto Zero Maintenance menu (AULZM).

In addition, more menus will appear that are transferred from the main setup menu when Legal-for-Trade settings are used.

Selection	Description
Industrial (INDU5)	This is the most common setting for the MSI-9600; With the Industrial standard, you have full range zero, access to units switching, filters, and peak hold
Handbook 44 (Hb-44)	Setting only relevant in NTEP certified MSI-9600 retrofits; Access is denied to Peak Hold, and the zero range may be limited; The Filter menu is moved to the Cal Setup menu, so filters are only accessible through the Cal Seal;
R-76 (R-76)	Setting not relevant for non-OIML use; Sets the scale to enable only approved features per OIML R-76; Only kg weight units are available; The zero range is limited to 4% (-1 to +3% relative to Calibrate zero); Net/Gross function is temporary; Once Net weight is established, pushing an F key set for Net/Gross will cause a maximum 5 second display of the Gross weight; You must clear the Tare to display Gross weight constantly; Other metrological aspects are changed to meet R-76 requirements; Only stable weights may be printed; Negative weight display is limited to -20d
One Unit (1UNIT)	The one unit Standard is exactly the same as Industrial, except units switching is inhibited; This is useful for Metric only countries; Another use of the One Unit standard is to allow the scale to be calibrated in units other than lb or kg, since conversions are eliminated; Contact MSI for more information on the Standards settings

Table 5-1. Legal Standard Menu Selections

Use the following steps to set up a Legal-for-Trade standard settings.







1. Remove the hex seal screw from the MSI-9600 using the steps from [Section 5.1 on page 34](#) and \square displays.
2. Press . SETUP displays.
3. Press  to enter the Cal setup menu.
4. Press  to enter the standard menu. The current standard setting displays.
5. Press  to scroll to the desired standard. 1UNIT displays.
6. Press  to set the standard. AULZM or the next item in the CAL setup menu displays.
7. Press  twice to exit setup and store all changes. STORE displays.

5.7 Auto Zero Maintenance

The MSI-9600 employs an auto-zeroing maintenance mechanism to adjust the zero reading to the center-of-zero (COZ). COZ is defined as the weight reading is within 1/4 'd' of zero. AZM continuously adjusts zero to maintain COZ.







It is recommended that AZM is on to maintain the highest accuracy. However, there are circumstances when it should be turned off. This can happen when minor variations of weight occur while picking up scale attachments and the variations fall within the AZM capture window. The AZM capture window (usually 1 'd') and capture time (usually eight seconds) can be adjusted by MSI to meet custom requirements. The settings of AZM are dictated in Legal-for-Trade standards and cannot be adjusted.

Use the following steps to set up the auto zero maintenance.

1. Remove the hex seal screw from the MSI-9600 using the steps from [Section 5.1 on page 34](#) and $\square RL$ displays.
2. Press . $SEtUP$ displays.
3. Press  to enter the Cal setup menu. $SEtAnd$ displays.
4. Press  to scroll to the Auto0 menu. $Auto0$ displays.
5. Press  to enter the Auto Zero menu. The current setting (blinking) displays.
6. Press  to scroll between the on or off key.
7. Press  to set the auto zero. $SEtAnd$ displays.
8. Press  twice to exit setup and store all changes. $StOR-E$ displays.

5.8 Filter

Changing the filter settings allows the scale to adjust to situations where there is a lot a movement in the structure. If the reading is not stable, it can often be improved by increasing the filter setting. Settling time will be longer as the filter setting is increased. However, the MSI-9600 employs algorithms that speed up large weight changes while still controlling vibration even with high filter settings. Selections are OFF , $L0$ and $H 1-1$.

1. Enter **Configuration** mode ([Section 5.1 on page 34](#)). $\square RL$ displays.
2. Press  to scroll to $SEtUP$.
3. Press . $SEtAnd$ displays.
4. Press  to scroll to $F ILT-r$.
5. Press . The current setting displays.
6. Press  to scroll to desired setting ([Section 4.9 on page 32](#)).
7. When desired value is displayed, press . $SEtAnd$ displays.
8. Press  twice to save settings. $StOR-E$ displays briefly and exits setup.

5.9 Gravity Compensation

Gravity Compensation allows for calibrating in one geographic location for use in a different geographic location. Gravity can be set to OFF, ON, or Factor.

Parameter	Choices	Description	
OFF		Gravity compensation disabled	
ON	--	Calculates Gravity compensation using the origin and destination latitudes and elevations	
	LRtOr	0-90	Latitude of Origin - Original latitude (to nearest degree) for gravity compensation; 47 (default)
	ELtOr	-9999-9999	Elevation of Origin - Original elevation (in meters) for gravity compensation; 10 (default)
	LRtdt	0-90	Latitude of Destination - Destination latitude (to nearest degree) for gravity compensation; 47 (default)
	ELtdt	-9999-9999	Elevation of Destination - Destination elevation (in meters) for gravity compensation; 10 (default)
FACTOr	--	Calculates gravity compensation using origin and destination gravity factors	
	FRcOr	9.00000-9.99999	Gravity of Origin - Original gravity factor (in m/s ²) for gravity compensation; 9.8080 (default)
	FRcdt	9.00000-9.99999	Gravity of Destination - Destination gravity factor (in m/s ²) for gravity compensation; 9.8080 (default)

Table 5-2. Gravity Compensation Parameters



NOTE: To find the local gravity, enter the latitude and elevation into the International Gravity Formula. Listed are links to websites that can be used to determine local latitude and elevation. Please note these website addresses are provided for reference only and may change.

Map Coordinates uses Google maps to find latitude and elevation: www.mapcoordinates.net/





Once local latitude and altitude have been determined, use the following link to calculate local gravity <http://www.sensorone.com/local-gravity-calculator/>













IMPORTANT: The gravity correction function has not been evaluated by an approvals agency, therefore it is up to the authorized scale dealer to ensure the device is accurate at the intended point of use.

5.9.1 Compensation by Latitudes and Elevations

1. Enter **Configuration** mode (Section 5.1 on page 34). \overline{CAL} displays.
2. Press to scroll to \overline{SEtUP} .
3. Press . \overline{StAnd} displays.
4. Press to scroll to $\overline{GrAViTY}$.
5. Press . The current setting displays.
6. Press to scroll to \overline{ON} .
7. Press . \overline{LRtOr} displays.
8. Press to enter latitude of origin.
9. Press . \overline{ELtOr} displays.
10. Press to enter elevation of origin.
11. Press . \overline{LRtdt} displays.
12. Press to enter latitude of destination.

13. Press . *ELEdt* displays.
14. Press  to enter elevation of destination.
15. Press  to accept elevation of destination.
16. Press  twice to save settings. *StorE* displays briefly and exits setup.

5.9.2 Compensation by Gravity Factor

1. Enter **Configuration** mode ([Section 5.1 on page 34](#)). *CRd* displays.
2. Press  to scroll to *SEtUP*.
3. Press . *StAnd* displays.
4. Press  to scroll to *GRAd*.
5. Press . The current setting displays.
6. Press  to scroll to *FRCGr*.
7. Press . *FRCGr* displays.
8. Press  to enter original gravity factor.
9. Press . *FRCdt* displays.
10. Press  to enter destination gravity factor.
11. When desired value is displayed, press .
12. Press  twice to save settings. *StorE* displays briefly and exits setup.

6.0 Communications

The MSI-9600 can communicate with peripheral devices using IEEE 802.15.4 Low Rate WPAN, or 802.11 Wi-Fi protocols, 'b', 'g' or 'n'. Only one communication type can exist at a time. Due to difficulties of dangling RS-232 cables from a hanging crane scale, the RF options are more commonly used.

The MSI-9600 has a single communications port allowing access to the embedded ScaleCore through the terminal access mode or Rice Lake software. The terminal access mode is used for updating scale firmware while Rice Lake software can be used for calibration and configuration, backup and adjusting scale settings. This communications port is not intended for output use.

6.1 Communications Setup



The 802.15.4 transceiver is used to communicate between the MSI-9600 and other connected ScaleCore devices. The 802.15.4 transceiver is also capable of connecting to any supported device with an 802.15.4 Modem. 802.15.4 operates in the 2.4 GHz ISM band and does not require the end user to obtain a license. 802.15.4 can coexist with other 2.4 GHz systems if caution is taken to isolate antennas at least 10' (3 m) from the crane scales.

The 802.11 Wi-Fi option communicates directly with a standard RF access point. This option is covered by the Wi-Fi for ScaleCore User Guide."

6.2 Printer and Serial Output Setup

All RF linked device Weigh modes are available in user formatted form.

Communications port settings are independent of print settings in connected displays/indicators which only in the MSI-9600.

1. Press  and  at the same time to enter the Communication menu. *Prnt* displays.
2. Press  to enter the Print Menu. *Listn* displays.

Parameters	Choices	Description
<i>Listn</i>	--	Listen – Connects with an RF remote
<i>Out-P</i>	<i>Port. 0</i> <i>RF</i>	Output Port – Select output port for print
<i>Strng</i>	--	Serial String – For use in printing (Section 6.2.1 on page 44)
<i>Ctrl</i>	<i>USER</i> <i>LoRd</i> <i>Cont mWdUS</i> <i>OFF</i>	Control – Print mode selected (Section 6.2.2 on page 44)
<i>Rate</i>	<i>0-65535</i>	Rate – Output rate in seconds, 0 is the fastest possible setting

Table 6-1. Print Parameters



NOTE: The serial output is configured as 9600 baud, Xon/Xoff handshaking, no hardware handshaking, 1 stop bit, no parity. Other baud rates are possible by special order only.

6.2.1 Standard Print Strings

Commands that can be used to format gross, net and print formats are shown below. Enter the desired print string number into the String parameter. Combinations of the standard print strings can be entered in the string number entry screen.

Example: To get a NET, GROSS, TARE printout with a space between records, enter 2349.

The print string characters in [Table 6-2](#) represent the variable character values in [Table 6-3](#). The ScaleCore Connect software can also be used to create custom output strings. ScaleCore Connect can be downloaded from www.ricelake.com.

Command	Description
<T>	Load data
<U>	Units
<M>	Load mode (lb/kg)
<CRLF>	Carriage return line feed
<SP>	Space
<STX>	Start of text character (ASCII 2)
<P>	Space for positive, - for negative
<W7.>	7-digit weight, floating decimal, leading spaces
<S>	Status, upper case: <SP> =OK, M=Motion, O=Overload, Z=Zero, I=Invalid

Table 6-2. Standard Print Characters

Print String Number	Parameter	Description
1	Current load	Fixed output length: 16; Leading zeros suppressed except for the least significant digit (LSD) <TTTTTT><SP><UU><SP><MMMMM><CRLF>
2	Net load	Fixed output length:16; Leading zeros suppressed except for the LSD <TTTTTT><SP><UU><SP>NET<SP><SP><CRLF>
3	Gross load	Fixed output length: 16; Leading zeros suppressed except for the LSD <TTTTTT><SP><UU><SP>GROSS<CRLF>
4	Tare Weight	Fixed output length: 16; Leading zeros suppressed except for the LSD <TTTTTT><SP><UU><SP>TARE<CRLF>
5	Total Weight	Fixed output length: 16; Leading zeros suppressed except for the LSD <TTTTTT><SP><UU><SP>TTL<CRLF>
6	Number of Samples Totaled	Fixed output length: 16; Leading zeros suppressed except for the LSD <SP><SP><SP><SP><SP><SP><SSSSSS><SP><T-CNT>SP<CRLF>
7	Rice Lake / Condec:	Stream Data Format <STX><P><W7.><U><M><S><CR><LF>
8/9	Carriage Return/Line Feed	Used to add a space between print records <CRLF>

Table 6-3. Standard Print Strings

6.2.2 Control Modes

The user can select three print control modes which are described below.

Mode	Description
USEr	Printing is controlled by the operator using  if set to Print mode; If using a remote device, there may be a dedicated PRINT key (F-key 3) available
LoAd	One print occurs when a stable load is read. The scale must then return to near zero before another print will occur; Note: Other configurations of loads are available using the ScaleCore Connect software. It can be downloaded from www.ricelake.com
Cont inUOUS	The MSI-9600 will continuously output the data at a rate specified in the rate parameter (up to 65,535 seconds); Setting the interval to 0 will set an interval as fast as the system can go
OFF	Printing is disabled. Power consumption is lower with the print off

Table 6-4. Control Modes

6.2.3 Printer Output Setup

Use the following steps to set up the printer output.

1. Press  and  at the same time. *Prnt* displays.
2. Press . *Unit* displays.
3. Press . The current setting flashes.
4. Press . *Out-P* displays.
5. Press . The current setting flashes.
6. Press  to toggle between *Port0* and *rF*.
7. When the desired setting displays, press . *Setn0* displays.
8. Press  to enter.
9. Enter the number using  to scroll through numbers and  to set the string number desired. ([Section 6.2.1 on page 44](#))
10. When set, press  again. *CentL* displays.
11. Press  to enter. Current setting flashes.
12. Press  to scroll through the settings. ([Section 6.2.2 on page 44](#))
13. When desired setting displays, press . *rRtE* displays.
14. Press  to enter.
15. Enter the number using  to scroll through numbers and  to set number.
16. Press  again. *Unit* displays.
17. Press  twice to save settings. *StorE* displays briefly and exits setup.



NOTE: When entering numbers, pressing  will step back a digit for corrections.

6.2.4 Custom Print Formatters

The ScaleCore Connect application is used to create custom output formatters. Download the ScaleCore Connect software from the Rice Lake website. For more information see the ScaleCore Connect software manual (PN 185725).

Custom formatters are also configured in the ScaleCore Webserver. For more information, see the ScaleCore Webserver technical manual (PN 208738).

The serial output is configured as 9600 baud, Xon/Xoff handshaking, no hardware handshaking, 1 stop bit, no parity.

Other baud rates are possible by special order only.

6.3 RF Network Setup

The MSI-9600 uses 802.15.4 transceivers to communicate with an MSI-8000 or MSI-8004HD Remote Display or another supported device with an 802.15.4 Modem.



NOTE: Ensure a relatively clear transmission path exists between the devices to be connected. Radio signals travel primarily by line of sight (LOS), obstructions between stations may degrade the system performance.

The optional second xBee radio can only be configured at the factory. It can not be configured through the front panel or ScaleCore Connect



6.3.1 802.15.4 RF Network Setup

When equipped with the 802.15.4 option, the MSI-9600 can connect with an MSI-8000 or MSI-8004HD Remote Display or another supported device with an 802.15.4 Modem.

Choices	Parameters/Range	Description
On, OFF	On OFF	Enable RF – Affects continuous mode only
Sc id	0-254	ScaleCore ID – Used to identify each ScaleCore device in a piconet, must not be duplicated within the same RF Channel
Chnl	12-23	RF Channel – Establishes the base network that all interconnected devices must match, range 12-23
Net id	0-99999	Network ID – A 64 bit number that all interconnected devices must match; The MSI-9600 limits this number to a max of 5 digits in a range of 0-99999 Note: Do not use a small number here to help avoid other 802.15.4 networks that default to a Network ID of 0 Range 0-99999
TYPE	2bEE 0tHEr	Connection Type – Type of card being used Note: 2bEE refers to XBee 802.15.4 RF card; Both XBEE 2SC, XBee 3 and XBee 3-Pro use the 2bEE parameter
Hold	On OFF	Setting Hold to On keep power to the radio even when the scale is turned off; This is required if the Rugged Remote or a remote display will be used to turn the MSI-9600 on; This causes some battery to drain when the scale is off; Hold should be set to off unless this is require in order to maximize battery life











Table 6-5. RF Menu Parameters















To configure RF Network:

1. Press the  and  keys at the same time. **Prnt** displays.



NOTE: BUSY may flash momentarily before entering the communications menu.

2. Press . **rF** displays.
3. Press . **On.OFF** displays.
4. Press  to enter parameter. The current value flashes.
5. Press  until **On** displays.
6. Press . **Sc id** displays.
7. Press . The current ID flashes. If SCID is correct, continue to [Step 9](#).
8. Enter the ID using  to scroll through numbers and  to set number.
9. When ID is set, press  again. **Chnl** displays.
10. Press . The current channel flashes. If the channel number is correct continue to 12.

11. Enter the channel using  to scroll through numbers and  to set number.
12. When channel is set, press  again. *net id* displays.
13. Press . The current net ID flashes. If the net ID is correct, continue to 15.
14. Enter the network ID using  to scroll through numbers and  to set number.
15. When the Net ID is set, press  again. *TYPE* displays.
16. Press  to enter parameter. The current value flashes.
17. Press  until *2bEE* displays.
18. Press . *Hold* displays.
19. Press  to enter parameter. The current value flashes.
20. Press  until desired setting displays.
21. Press . *On. OFF* displays.
22. Press  twice to save and exit to **Weigh** mode.

 **NOTE:** When entering numbers, pressing  will step back a digit for corrections.











6.3.2 Hold Feature

The hold feature is used to keep the modem on even when the display is off. It is used if desired with a rugged remote or a remote display.



NOTE: The hold feature causes the device's modem to remain on when the device is turned off. This continuously draws from the battery, decreasing battery life.

To Enable it follow these steps:

1. Press  and  simultaneously. *Prnt* displays.
2. Press . *rF* displays.
3. Press . *On OFF* displays.
4. Press  to enter *On OFF*.
5. Press  to select *On*.
6. Press  to scroll to *Hold*.
7. Press  to enter the *Hold*.
8. Press  to select *On*.
9. Press  twice to store settings and return to Weigh mode.

6.4 Radio Compliance

All radio options meet FCC and international radio compliance per the certification information listed in this section.

These modules may have additional international certifications that are not listed in this section.

Please contact Rice Lake Weighing Systems if you require operation in a jurisdiction that is not listed.

6.4.1 802.15.4 (XBee 3 and XBee 3-PRO)

FCC Statement

Contains FCC ID: MCQ-XBEE3

International Certifications

Canada: Radio Certificate Number: IC 1846A-XBEE3

Australia: RCM

Brazil: ANATEL 06329-18-01209

EU (XBee 3 only): Yes, when used with CE approved products

Japan (XBee 3 only): R210-119309

Mexico: IFETEL (IFT) RCPDIXB19-1820

South Korea (XBee 3 only): R-C DIG-XBEE3

6.4.2 802.15.4 (XBee 2SC)

FCC Statement

Contains FCC ID: MCQ-S2CTH

International Certifications

Canada: Radio Certificate Number: IC 1846A-S2CTH

Australia: RCM

Brazil: ANATEL 0616-15-1209

EU: Yes, when used with CE approved products

Japan: R210-105563

Mexico: IFETEL (IFT) RCPDIS219-1821-A1

South Korea: MSIP-CRM-DIG-XBee-S2C-TH

6.4.3 Wi-Fi

FCC Statement

Contains FCC ID: T9J-RN171

International Certifications

Canada: Radio Certificate Number: IC 6514A-RN171

Korea: Radio Certificate Number: KCC-CRI-029-RN-171

Europe: The product is compliant with the following standards and/or other normative documents:

- EN 300 328 : V1.8.1 (2012)

This product is compliant with the following standards and/or other normative documents:

Safety (article 3.1A) EN 60950-1:2006+A11:2009+A1:2010+A12:2011

EMC (article 3.1b) EN 301 489-1 : V1.9.2 (2011) In accordance with the specific requirements of ETSI EN 301 489-17: V2.2.1 (2012)

6.4.4 Bluetooth

FCC Statement

Contains FCC ID: T9J-R41-1

International Certifications

Canada: Radio Certificate Number: IC 6514A-RN411

Europe: This product is compliant with the following standards and/or other normative documents:

- EN 300 328-1
- EN 300 328-2 2.4GHz

6.4.5 FHSS (Frequency Hopper Spread Spectrum)

FCC Statement

Contains FCC ID: HSW-DNT24

International Certifications

Canada: Radio Certificate Number: IC 4492A-DNT24

ETSI Certified

7.0 Optional Rugged Remote

The MSI-9600 with an installed RF modem can be controlled with an optional Rugged Remote. The Rugged Remote is a transmit only device that can be used to perform basic scale functions. The range may vary up to 100' or more depending on room conditions and line of sight.

The RF modem in the MSI-9600 must be configured to accept communication from the Rugged Remote, contact Rice Lake Weighing Systems for pairing requirements.



NOTE: A Rugged Remote is paired to an individual device and cannot be reprogrammed in the field.



Figure 7-1. Rugged Remote

7.1 Operation

The Rugged Remote is paired to a single ScaleCore RF device and replicates the front panel buttons. Slight variations between each device's buttons will result in different operation in the Rugged Remote. See Table 7-1 for corresponding buttons for the Rugged Remote and the connected device.



NOTE: The Rugged Remote can only be paired to a single ScaleCore device. Reprogramming to configure communication to a different ScaleCore device can only be performed at the factory or with the purchase of additional RF modems.

Rugged Remote	MSI-9600	Description
		Power
		Zero
		Tare
		Function

Table 7-1. Corresponding Buttons

7.1.1 Power

The Rugged Remote can be enabled to turn on and off the ScaleCore device it is paired remotely. The hold function must be enabled in the MSI-9600 ([Section 6.3.2 on page 48](#)).



NOTE: The Hold feature causes the device's modem to stay on and continuously draw from the battery, even when the device is turned off, resulting in decreased battery life.

7.1.2 Zero



Press  to remove small deviations in zero when the MSI-9600 is unloaded ([Section 3.2 on page 23](#)).

This key is not programmable.

7.1.3 Tare

Press  to tare the MSI-9600 is unloaded ([Section 3.3 on page 23](#)).

7.1.4 Programmable Function Keys

 and  are programmable in the MSI-9600. Function is defaulted to Test in the MSI-9600. See [Section 4.2 on page 28](#) to configure the MSI-9600 function key for Rugged Remote operation.

7.2 Conflict and Jamming Considerations

It is important to understand that only one transmitter at a time can be activated within a reception area. While the transmitted signal consists of encoded digital data, only one carrier of any frequency can occupy airspace without conflict at any given time. This is not to say that there cannot be multiple remote controls for the unit, but rather that two cannot be used simultaneously.

7.3 FCC Compliance

The Rugged Remote has 802.15.4 certification ([Section 6.4 on page 48](#)).

8.0 Troubleshooting/Maintenance

8.1 Troubleshooting

Problem	Possible Cause	Solution
The display is blank when the POWER button is depressed	Discharged battery	Recharge the battery; Allow at least four hours charge
	Defective battery	Replace the battery
	Corroded battery or battery contacts	Clean the battery contacts
	Defective switch or circuit board	Requires authorized service
The display does not function properly, the front panel button does not function normally or the scale will not turn off	Improperly updated software	Reinstall the software
	Faulty circuit board	Requires authorized service
	Loose connectors	Requires authorized service
The scale does not respond to weight changes	Out of calibration	Calibrate the unit
	Faulty load cell	Replace the load cell
	Load cell connector	Check the connector and wires
Full displays during calibration	Calibration load greater than capacity	Check scale capacity and select proper load
	Different calibrations on the same point	
	Different weight on the same point	
	Same weight on different loads	
The display over ranges below 100% capacity	Tared weight is added to load to determine overload point	Return to gross Weigh mode
	Zero requires adjustment	Rezero the scale
	Too much weight has been zeroed	Rezero the scale
The display drifts	AZM (Auto0) is turned off	Turn AZM on
	Rapid temperature changes such as moving the scale from indoors to outdoors	Wait until the scale temperature has stabilized
	Bad load cell	Check load cell and load cell wiring
The displayed weight shows a large error	Scale not zeroed before load is lifted	Zero the scale with no load attached
	lb/kg units causing confusion	Select the proper units
	Requires recalibration	Recalibrate the unit
	Damaged load cell	Check load cell and load cell wiring
The display reading is not stable	Excessive vibration in crane system	Increase filtering or increase 'd' in Cal
	Excessive side loading	Improve load train symmetry
	Load cell faulty	Check the load cell connections
The display toggles between "Error" and "Load"	Weight exceeds capacity	Reduce weight immediately
	Calibration Faulty	Recalibrate
	Faulty load cell or wiring	Check load cell and load cell wiring
The display toggles between "Error" and "UnLd"	Weight in below the zero range	If the scale is in compression, remove the source
	Calibration faulty	Recalibrate
	Faulty load cell or wiring	Check the load cell connections
The display toggles between "Error" and "A2DLo"	A/D is saturated negative	Check the load cell and load cell wiring
Display toggles between "Error" and "buttn"	A key is stuck or is being held down	Check switches for damage Ensure that a remote is not transmitting continuously
Rugged Remote does not work	Units are not paired	See Section 6.3 on page 46
Some Rugged Remote keys do not work but the ACK light blinks	The keys were not enabled during the setup process	Enable the keys by running the transmitter and receiver address procedures
Lo Batt is blinking	The battery is low	Recharge the battery
Unit turns on, then immediately turns off	The battery is low	Recharge the battery
Weight will not zero	The system not stable	The stable annunciator must turn on for Zero to function; Increase the filtering for more stability Increase the filtering for more stability
	Zero is out of range	Legal-for-Trade units have limited zero range; Reduce the weight or use Tare instead
The weight will not Zero, Tare or Total	The system is not stable	Wait for Stable annunciator to turn on, or if in a mechanically noisy crane, increase the filtering or increase the size of the scale increment "d". It is also possible to increase the motion window; Contact MSI if you have a problem getting the MSI-9600 to zero, tare, or total due to stability issues
Setpoint lights blink	Setpoint enabled and trigger point reached	Disable set points if they are not needed

Table 8-1. Troubleshooting

Problem	Possible Cause	Solution
Manual total does not work	A Function key is not set to "Total"	Set up Func1 or Func2 for "Total"
	The weight must be stable	Increase filtering for more stability
Auto Total does not work	The weight must be stable	Wait for the stable annunciator to turn on, or Increase filtering for more stability
	Weight thresholds not reached	Must exceed 1% of capacity for autototal to work; Must drop below 0.5% of capacity for additional weighments to register

Table 8-1. Troubleshooting (Continued)

8.2 Service Counters



IMPORTANT: Only a Rice Lake Weighing Systems factory representative can reset the service counters, as these are an important safety warning feature. A thorough load train inspection is necessary to ensure product safety.

Service Counters are important safety warning features and can only be reset at the factory by certified Rice Lake personnel.



As part of the reset process, the service technician will perform a thorough load train inspection to ensure user safety and confirm that the product is ready to be returned for regular service.

See the Crane Scale Safety and Periodic Maintenance Manual (PN 153105) for proper loading techniques to improve the safety and longevity of your MSI Overhead Weighing Product. Download the Crane Scale Safety and Periodic Maintenance Manual (PN 153105) at www.ricelake.com.

The MSI-9600 maintains two service counters for safety.

- The first one counts the number of times the scale has been overloaded
- The second counter counts lifts above 25% of capacity

These counters serve to warn the user to inspect the load train after a number of overloads, also when there is a chance of fatigue failure. The power up routine will be interrupted when the lift counter exceeds 16383 lifts or the overload counter exceeds 1023 overloads. If the screen displays *LFEN* when unit is powered on:



1. Press  to display the 25% lift counter.
2. Press  again to see the overload lift counter.
3. Press  to acknowledge the warning and return to standard scale operation.



NOTE: The power up warning message will not appear again for another 16383 lifts (or 1023 overloads).





Access the Service Counters

Use the following steps to access the service counters.

1. Program a user function key to be LFCnt (Section 4.2 on page 28).
2. Press  .
3. Press  . The display flashes
 - LFCnt (for Lift Counter) followed by the number of times the weight has exceeded 25% of capacity
 - OLCnt (for Overload Counter) followed by the number of times the weight has exceeded capacity
 - C-Cal followed by the C-Cal value

Then the display returns to the **Weigh** mode.

To stop the scrolling and step through them slowly proceed to [Step 4](#).

4. Press  immediately after  is pressed.
5. Press  to scroll through counters.
6. Press  to enter the counter, the value displays.
7. Press  to return to Weigh mode.



NOTE: After service counters are viewed a few times, the automatic warning stops, but counters continue to monitor lifts.

9.0 Specifications

Accuracy

10,000 to 70,000 lb: $\pm (-.1\% +1 \text{ d})$ of capacity
100,000 to 200,000 lb: $\pm (0.2\% +1 \text{ d})$ of capacity

Resolution

3,000 to 5,000 d standard (up to 10,000 d available)

Enclosure

NEMA Type 4, IP66 marine grade 356 alloy anodized cast aluminum

Lifting Eye, Shackle and Hook

Shackle is optional and Crosby® fixed hook provided as standard

Design Overload

200% Safe / 500% Ultimate (except where noted)

Functions

Power: Turns unit on or off
Zero: Zeros applied load up to 100% of capacity
Tare: Tares applied load and displays weight in net
Mode F1: Programmable as test, units, net/gross, total and peak hold

Display

6 digit, 1.5 in (38 mm) LED with programmable brightness control

Displayable Units

Pounds or kilograms selectable

Power

12 Volt rechargeable battery, 115/230 VAC battery charger included

Operating Time

Up to 250 hours between charging without radio
Up to 75 hour between charging with radio
Operating time is dependent on number of connected radios

Temperature Range:

Operating: -40°F to 140°F (-40°C to 60°C)
Maximum Operating: -76°F to 176°F (-60°C to 80°C)
Radio may not be reliable below -40°F (-40°C)
Continuous operation above 140°F (60°C) may reduce battery life

Calibration

Digital

Filtering

OFF, LO, HI-1, HI-2 selectable

Radio Link

802.15.4 at 2.4 GHz

Radio Link Effective Range

Typically 100 to 300 ft line of sight

Warranty

One-year limited

Certifications

MSI-9600 retrofit of MSI-9300 only
NTEP CC19-122A1
500 to 2000 lb Class III
5000 to 70,000 lb Class III/L
Certified Temperature Range: 14°F to 104°F (-10°C to 40°C)

9.1 Dimensions

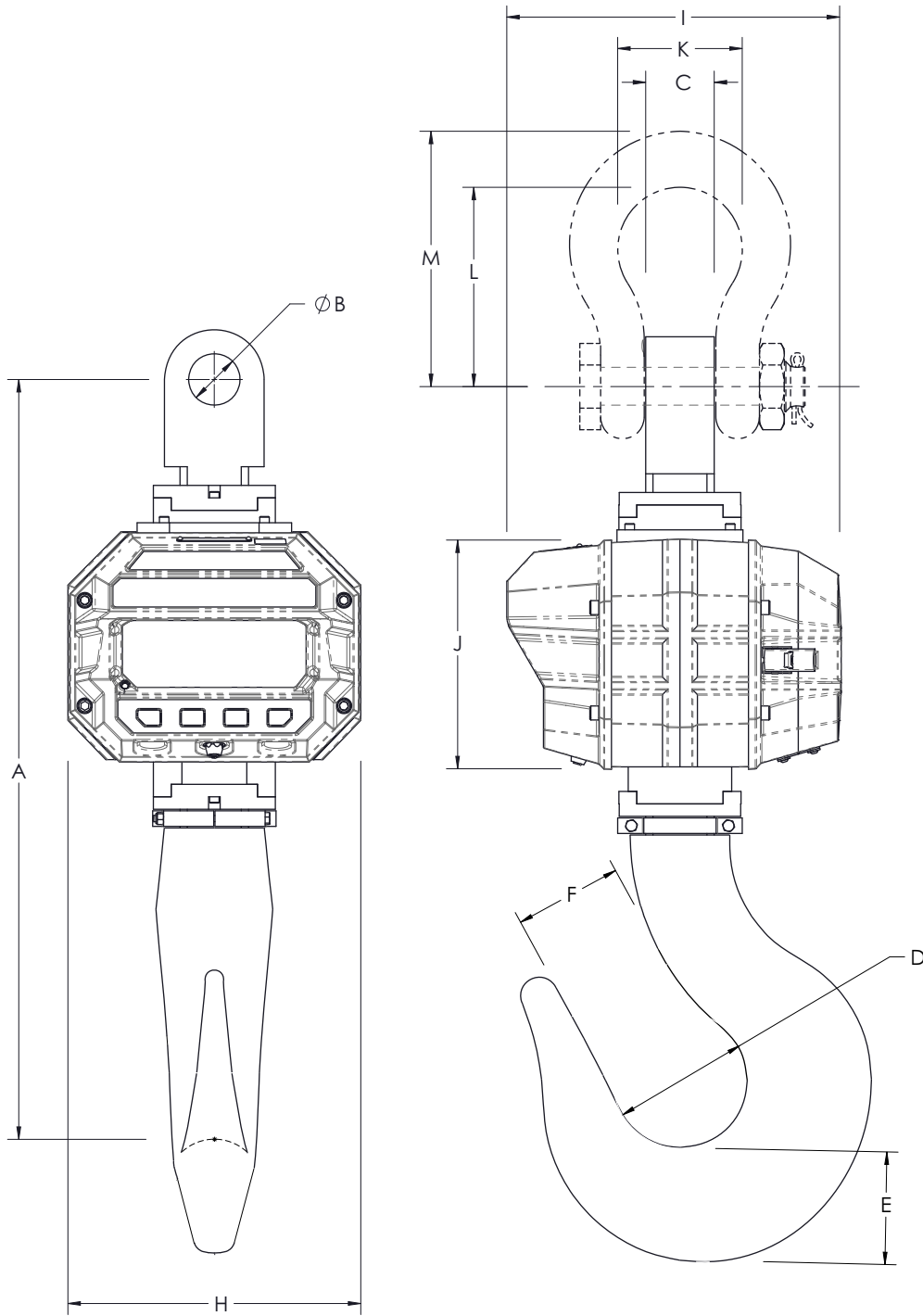

Figure 9-1. Dimensions 10,000 lb to 70,000 lb Capacity

Part No.	Capacity	A	B	C	D	E	F	H	I	J	K	L	M
214371	10K lb	19.6 in	Ø1.28 in	1.75 in	2.50 in	1.82 in	1.78 in	11.80 in	13.40 in	9.20 in	2.91 in	4.88 in	6.13 in
214370	30K lb	23.4 in	Ø1.66 in	2.15 in	4.25 in	3.01 in	3.41 in	11.80 in	13.40 in	9.20 in	3.88 in	6.57 in	8.19 in
214369	70K lb	30.5 in	Ø2.06 in	2.75 in	5.38 in	4.56 in	4.25 in	11.80 in	13.40 in	9.20 in	5.00 in	8.00 in	10.25 in

Table 9-1. Dimensions 10,000 lb to 70,000 lb Capacity

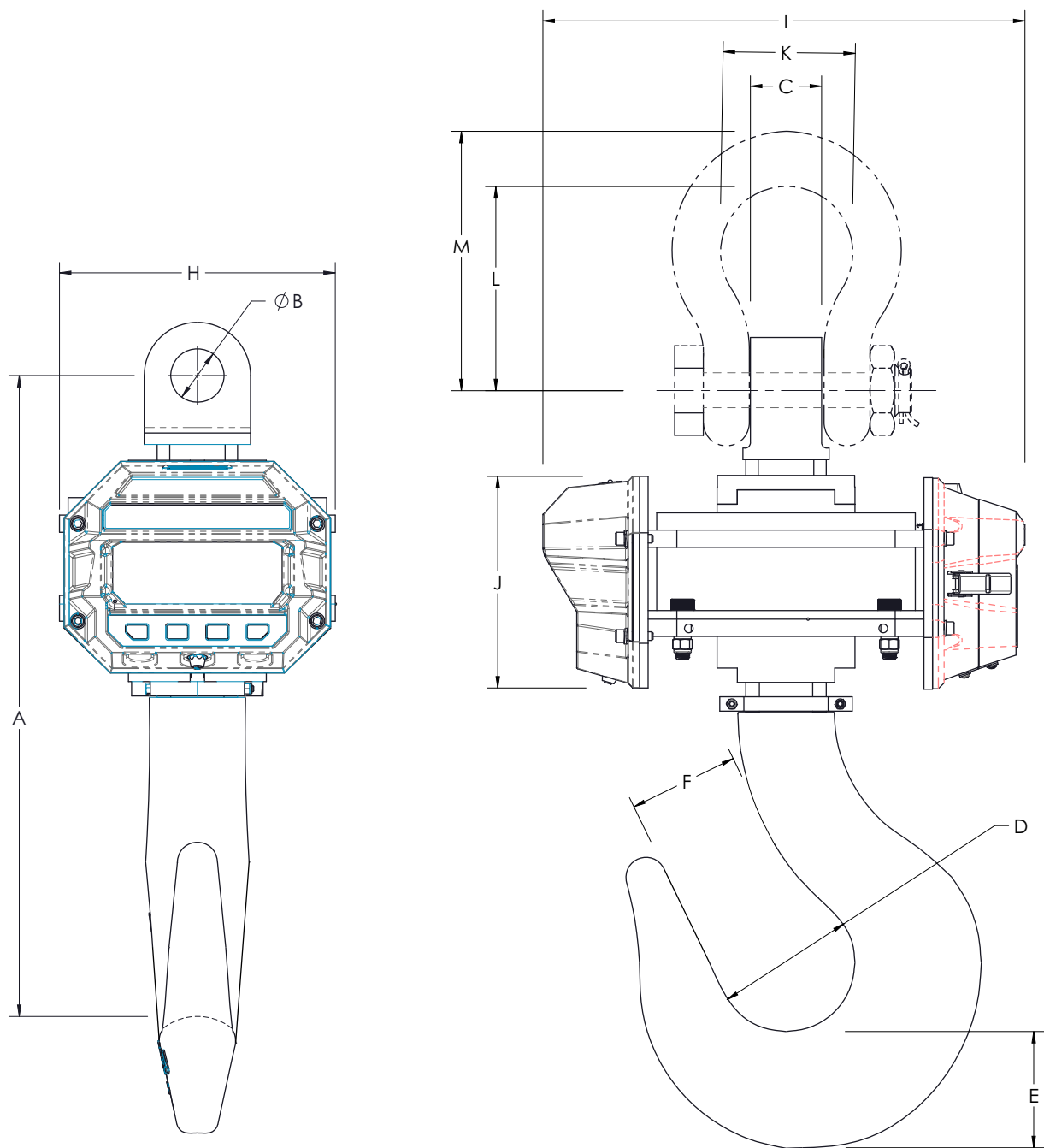

Figure 9-2. Dimensions 100,000 lb to 200,000 lb Capacity

Part No.	Capacity	A	B	C	D	E	F	H	I	J	K	L	M
214477	100K lb	27.9 in	Ø2.32 in	3.10 in	3.00 in	5.06 in	4.75 in	12.00 in	20.90 in	9.20 in	5.75 in	8.88 in	11.28 in
214474	120K lb	29.5 in	Ø2.32 in	3.10 in	7.00 in	6.00 in	5.75 in	12.00 in	20.90 in	9.20 in	5.75 in	8.88 in	11.28 in
214479	200K lb	35.4 in	Ø2.81 in	3.75 in	6.81 in	8.59 in	5.88 in	13.30 in	23.00 in	9.20 in	7.25 in	11.88 in	15.00 in

Table 9-2. Dimensions 100,000 lb to 200,000 lb Capacity



© Rice Lake Weighing Systems Content subject to change without notice.

230 W. Coleman St. • Rice Lake, WI 54868 • USA USA: 800-472-6703 • International: +1-715-234-9171