

SCT-1SX-MODBUS TCP/IP

Quick Start Guide

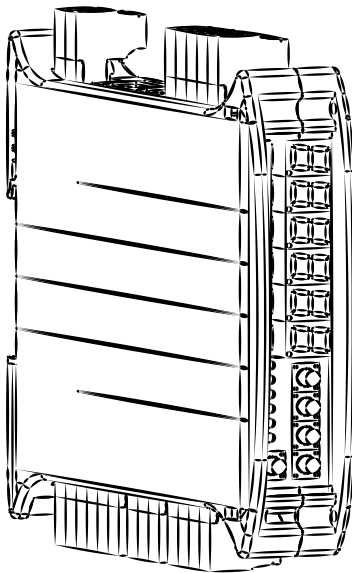

1. Electrical Schematic

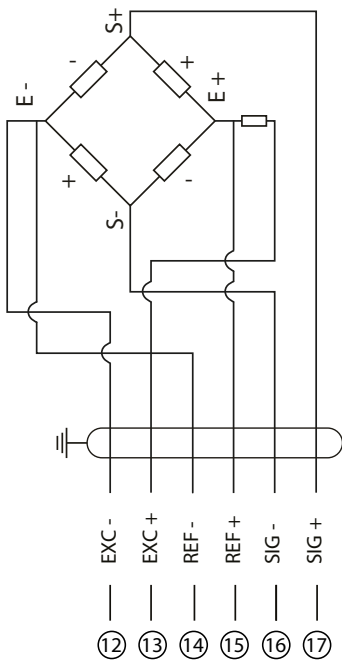

⚠ Load cells excitation: 5 V.
Load cells output: 6 mV/V max.

⚠ INPUT: 12 to 48 Vdc
OUTPUT: 48Vac or 60Vdc, 0.5 A max

UL For UL approved models:
equipment to be powered by
12 to 24 Vdc LPS or Class 2
power source.

⚠ CONSUMPTION: 4 W max.
(without load cells).

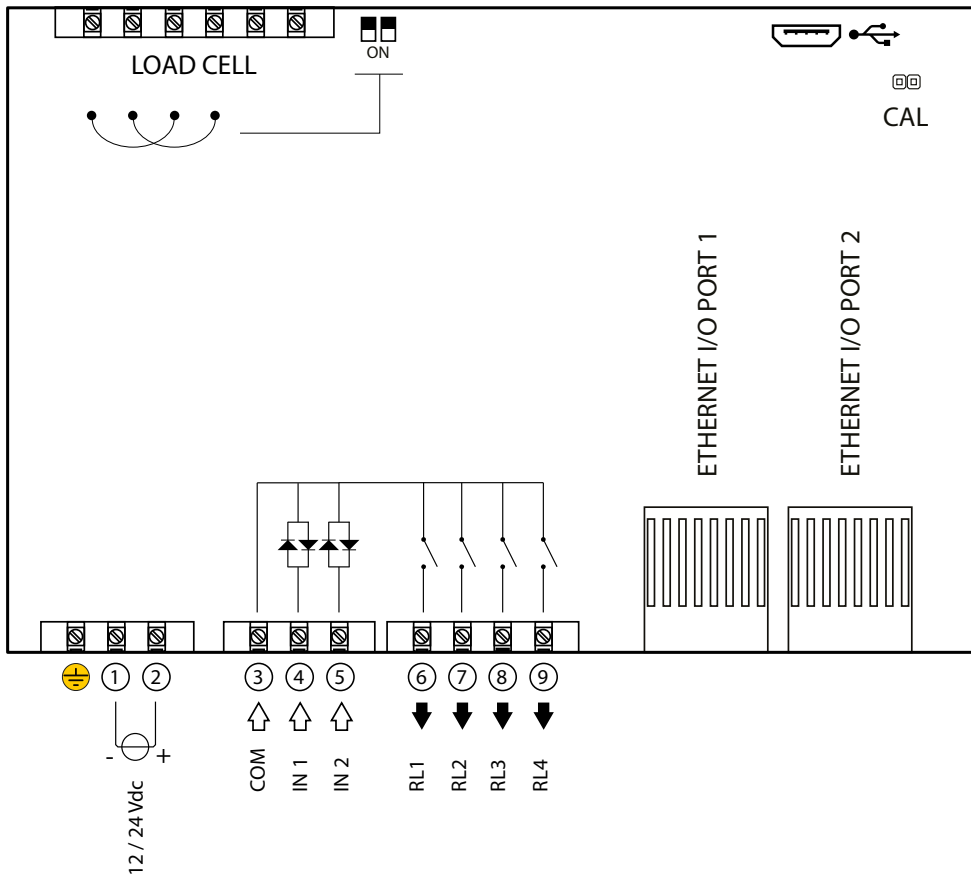

Manuals are available from Rice Lake Weighing Systems at www.ricelake.com/manuals
Warranty information is available at www.ricelake.com/warranties

2. Key Functions

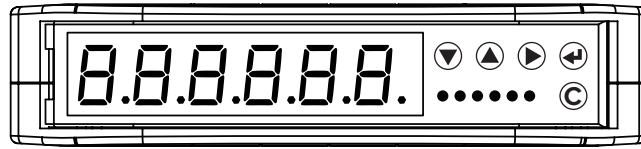

| Configuration menu | |
|--------------------|---|
| ▼ | Decreases digit / Scrolls down. |
| ▲ | Increases digit / Scrolls up. |
| ▶ | Enters the setup. Selects digit to modify. |
| ◀ | Enters a step / Confirms. |
| C | Clears / Exits a step (no save). |

| Weighing mode | |
|---------------|---|
| ▼ | Clears the displayed gross weight. |
| ▲ | Short press: executes semiautomatic tare. Long press: allows to enter known tare. |
| ▶ | Activates / deactivates the function. |
| ◀ | Short press executes data transmission on the printer serial port. Long press: Setpoint configuration. |
| C | ON/Standby of the instrument. |

3. Indicator Light Descriptions

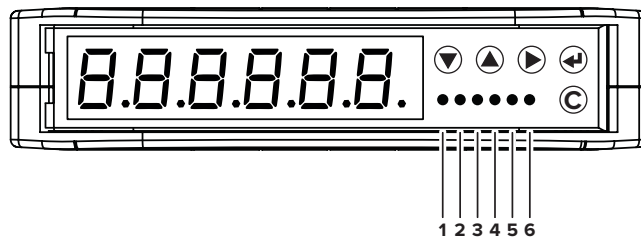

| | |
|---|-----------------------------|
| 1 | Weight on zero. |
| 2 | Unstable weight. |
| 3 | A tare is active. |
| 4 | A function is active. |
| 5 | Digital output 1 is active. |
| 6 | Digital output 2 is active. |

4. Configuration Menu

1. Reboot the weight transmitter
2. Press the ► key when display shows the *888888* message:

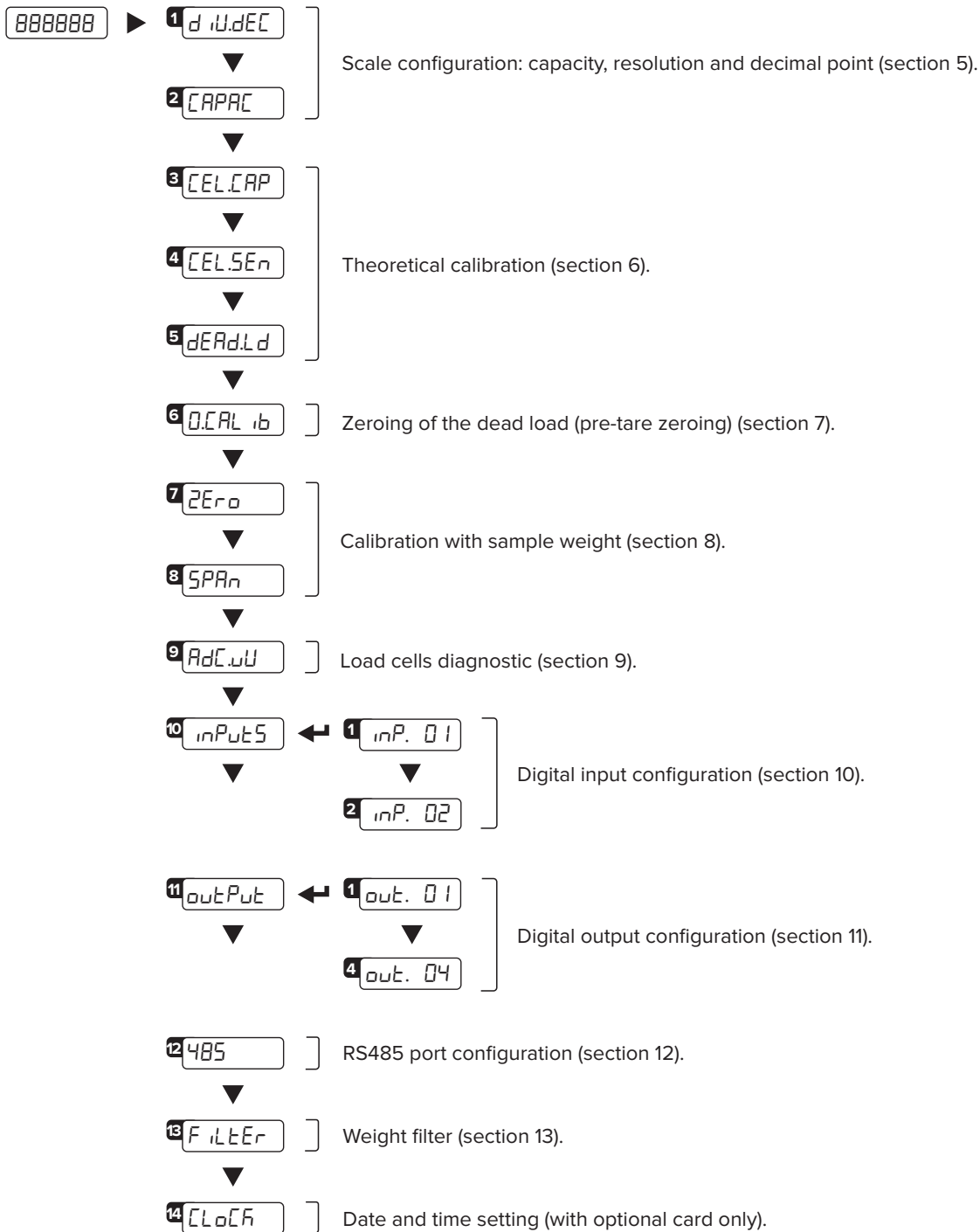

HOW TO EXIT THE MENU AND SAVE YOUR CONFIGURATION

1. Press **C** key repeatedly until *SAVE?* appears; press **←** to save or press **C** to exit without saving.

5. Maximum Scale Capacity, Increment and Decimal Point Settings

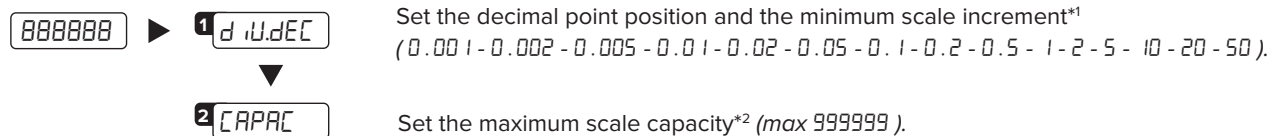

Examples:

For a 60000 lb scale, with 2 lb increment:
 d.u.dEC = 2
 CAPAC = 60000

For a 10000 g scale, with 0.1 g increment:
 d.u.dEC = 0.1
 CAPAC = 10000.0

For a 3000 lb scale, with 0.05 lb increment:
 d.u.dEC = 0.05
 CAPAC = 3000.00

*1 Increment = the amount that the scale will increment by as weight is added or removed.

*2 Maximum capacity = the maximum weight that can be measured using the scale you are creating.

6. Theoretical Calibration

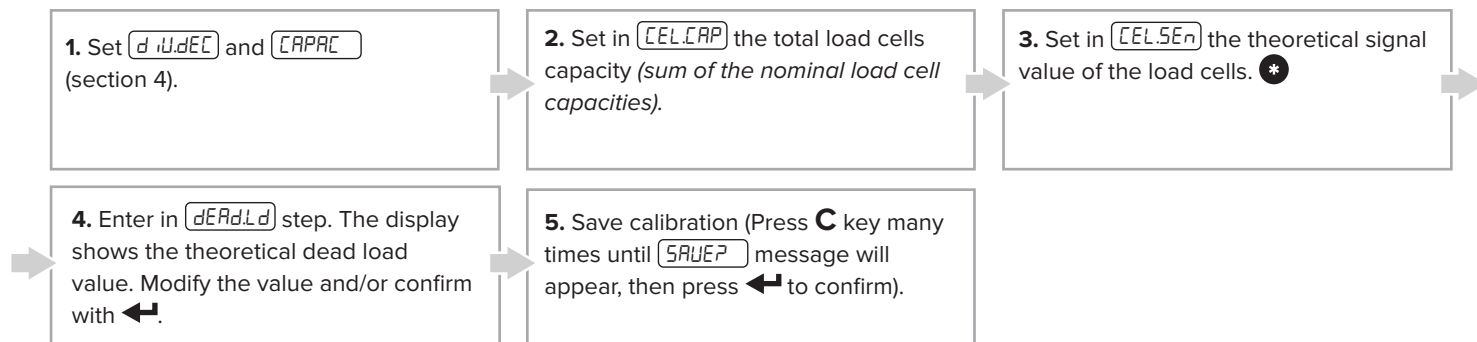
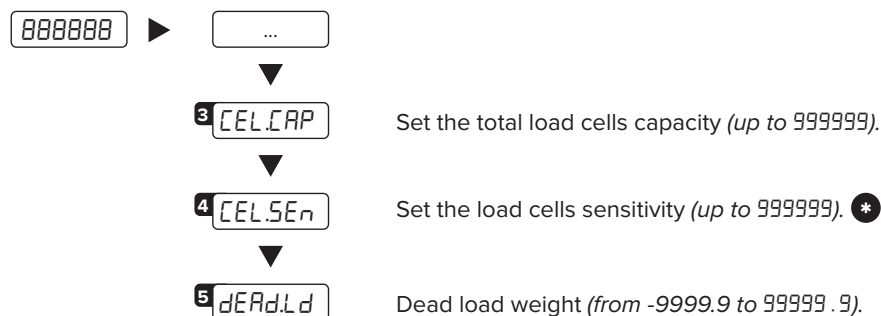

7. Zero Mechanical Tare (pre-tare zeroing)

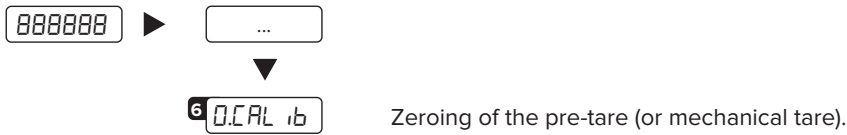

This functionality allows to zero the weigh of the scale structure (e.g. empty silo, conveyor, etc.) without changing the calibration in memory.

8. Calibration with Sample Weight

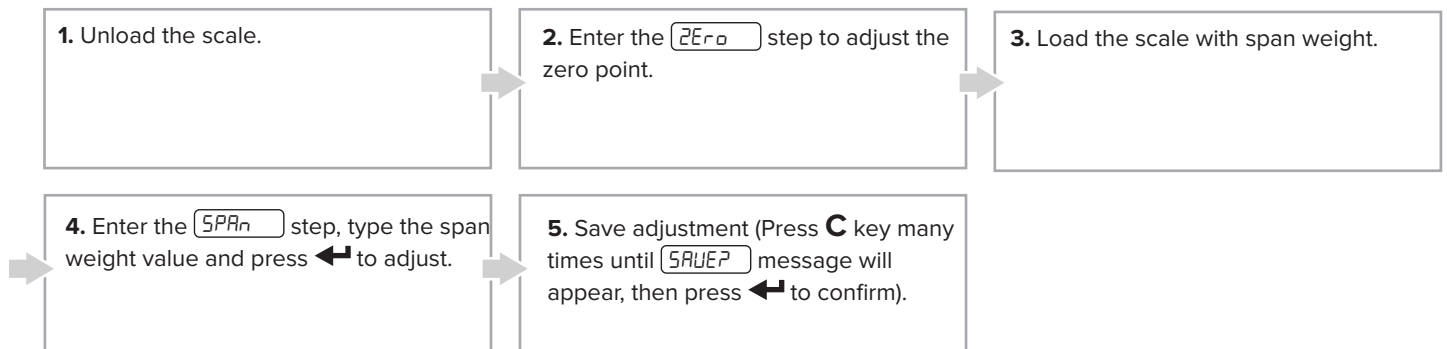
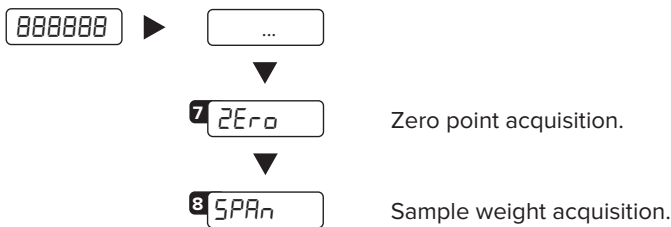

9. Load Cells Diagnostics ($\mu\text{V}/\text{V}$)

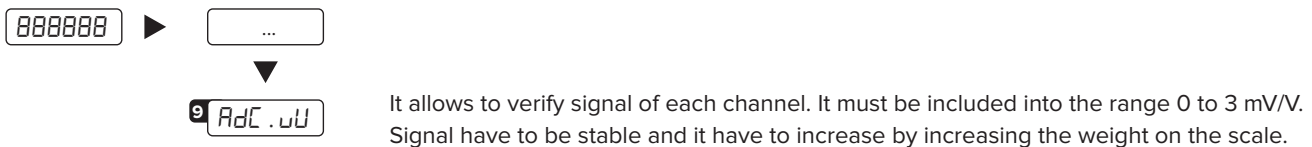

10. Input Settings

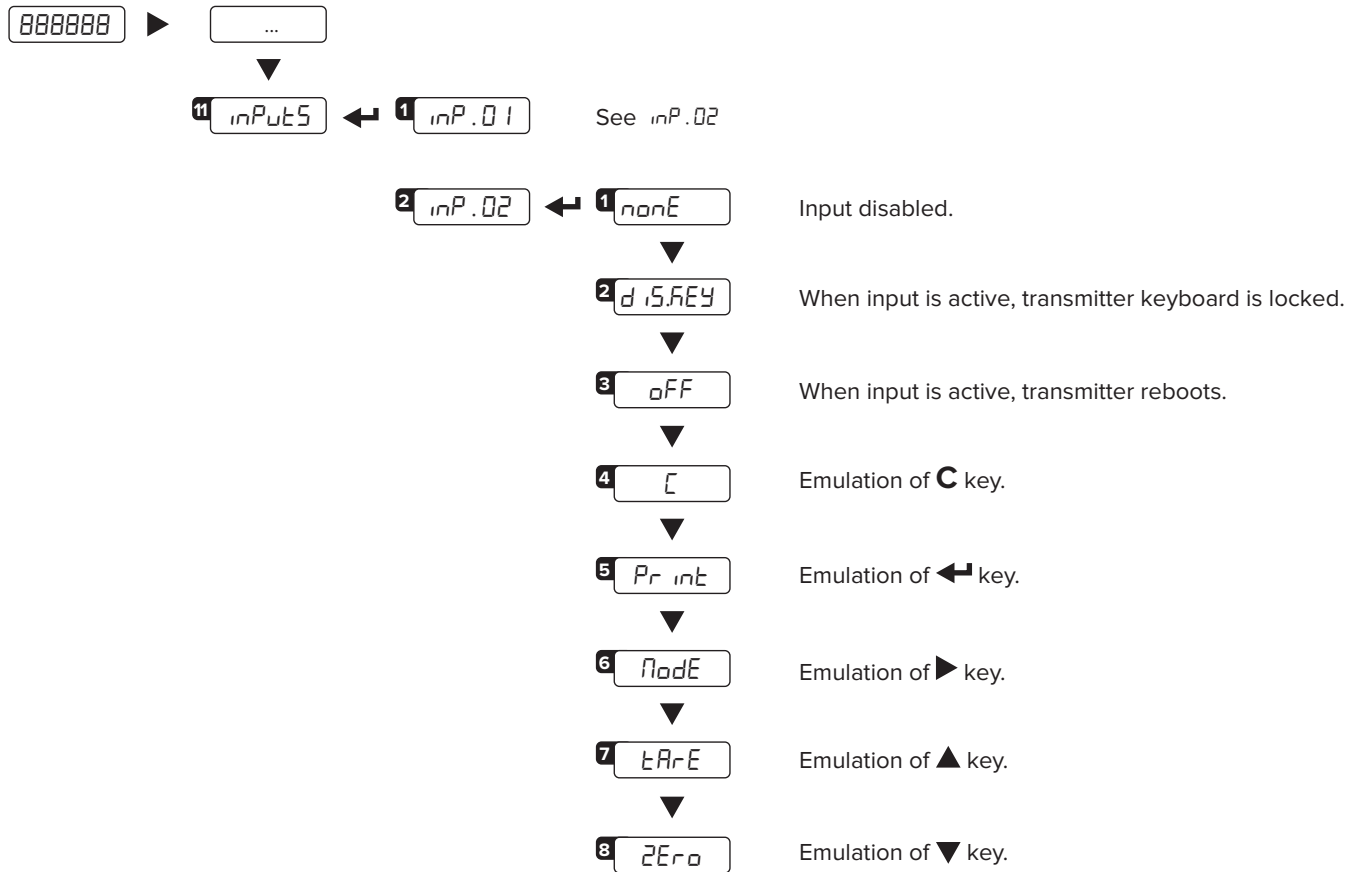

11. Output Settings

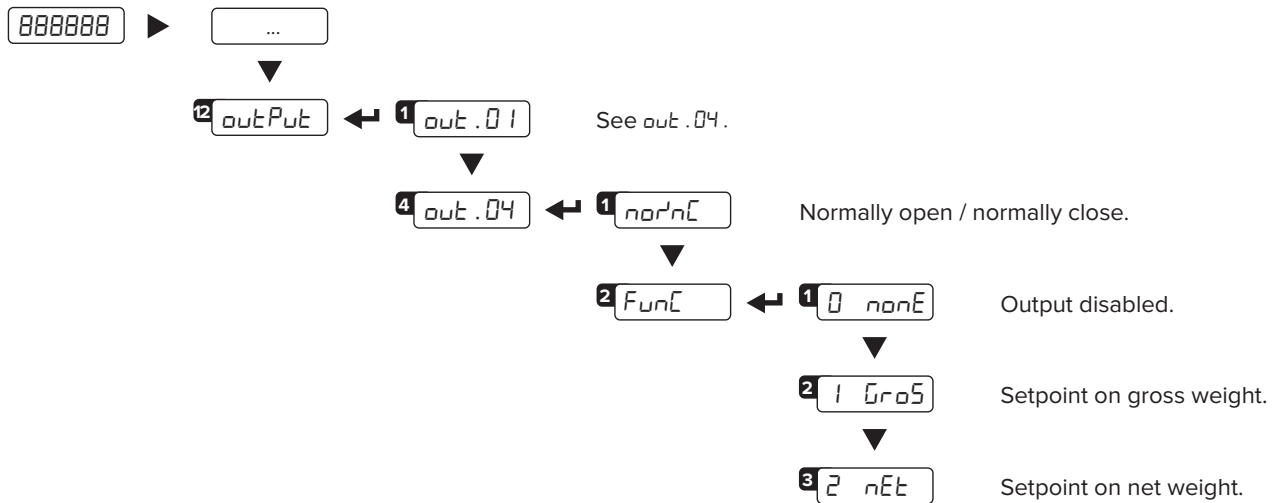

11.1 HOW TO PROGRAM SETPOINTS

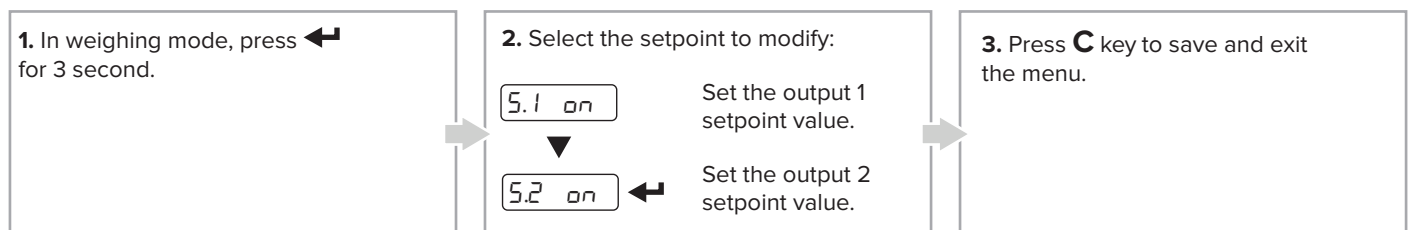

12. Fieldbus Settings

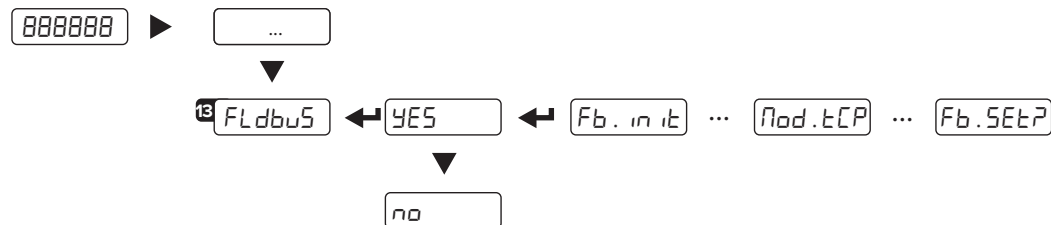

Set the IP address:

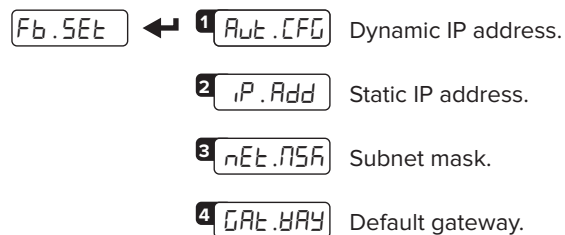

13. Weight Filter

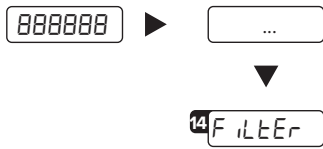

The active weight filter is displayed, alternating with the weight value.
Press ▲ and ▼ keys to scroll through the available filters (from slowest to fastest, F1 to F11).

14. Programming Errors

| MESSAGE | DESCRIPTION | SOLUTION |
|----------------------|---------------------------|--|
| <i>P r E C .</i> | Calibration error | First calibrate the zero point (<i>Z E r o</i>), then proceed with sample weight acquisition (<i>S P R n</i>) (section 9). |
| <i>E r r . P n t</i> | Calibration error | Check the connection of the load cell. Verify the load cell signal is stable, valid and greater than the previously acquired point. |
| <i>E r 11</i> | Calibration error | Increase the calibration weight. |
| <i>E r 12</i> | Calibration error | Check the signal from the load cell increases when weight is incremented on the scale. |
| <i>E r 37</i> | Calibration error | Repeat calibration and verify capacity and division have been correctly set. |
| <i>E r 39</i> | Instrument not configured | Transmitter needs to be configured. |
| <i>C . E r . 36</i> | Calibration error | Verify the signal from the load cell is not negative. |
| <i>C . E r . 37</i> | Calibration error | Verify the signal from the load cell is not negative. |
| <i>E r r . N o t</i> | Weight unstable | Check in <i>A d C . u l</i> parameter that the signal is stable. If the connection of the cells is with 4 wires, check that the sense jumpers are inserted. |
| <i>A d C . E r r</i> | A/D converter error | Converter failure. Reboot the instrument. |
| <i>C E L . E r r</i> | Global load cell error | Signal anomaly: check the load cells connection. |

15. Modbus TCP

15.1 MODBUS TCP REGISTERS

| Data | Register | DESCRIPTION | | | | | | | | | | | | | |
|-------------------------|-----------|--|--------|--------|----------------|---|---|-----------|---|---|-----------|---|---|-----------|---|
| Gross weight | 30001 (H) | Registers 30001 and 30002 contain the Gross Weight value. | | | | | | | | | | | | | |
| | 30002 (L) | | | | | | | | | | | | | | |
| Net weight | 30003 (H) | Registers 30003 and 30004 contain the Net Weight value. | | | | | | | | | | | | | |
| | 30004 (L) | | | | | | | | | | | | | | |
| Input status register | 30005 | Bit 15 _(msb) Active channel. Bit 14 Active channel. Bit 13 No function. Bit 12 No function. Bit 11 No function. Bit 10 No function. Bit 9 Status of input n. 2. Bit 8 _(lsb) Status of input n. 1. | | | | | | | | | | | | | |
| | | <table border="1"> <thead> <tr> <th>Bit 15</th> <th>Bit 14</th> <th>Active Channel</th> </tr> </thead> <tbody> <tr> <td>0</td> <td>0</td> <td>Channel 1</td> </tr> <tr> <td>0</td> <td>1</td> <td>Channel 2</td> </tr> <tr> <td>1</td> <td>0</td> <td>Channel 3</td> </tr> <tr> <td>1</td> <td>1</td> <td>Channel 4</td> </tr> </tbody> </table> Bit 7 _(msb) 1 = Scale unloaded (gross weight = 0). Bit 6 Tare PT (1 = PT tare is active). Bit 5 Tare (1 = Tare is active). Bit 4 Overload condition (0 = No; 1 = Overload). Bit 3 Underload condition (0 = No; 1 = Underload). Bit 2 Weight Stability (0 = Unstable; 1 = Stable). Bit 1 Gross Weight Polarity (0 = "+"; 1 = "-"). Bit 0 _(lsb) Net Weight Polarity (0 = "+"; 1 = "-"). | Bit 15 | Bit 14 | Active Channel | 0 | 0 | Channel 1 | 0 | 1 | Channel 2 | 1 | 0 | Channel 3 | 1 |
| Bit 15 | Bit 14 | Active Channel | | | | | | | | | | | | | |
| 0 | 0 | Channel 1 | | | | | | | | | | | | | |
| 0 | 1 | Channel 2 | | | | | | | | | | | | | |
| 1 | 0 | Channel 3 | | | | | | | | | | | | | |
| 1 | 1 | Channel 4 | | | | | | | | | | | | | |
| Command status register | 30006 | Last received command. | | | | | | | | | | | | | |
| | | Bit 7 _(msb) Last command result. Bit 6 Last command result. Bit 5 Last command result. Bit 4 Last command result. Bit 3 Counting of processed commands. Bit 2 Counting of processed commands. Bit 1 Counting of processed commands. Bit 0 _(lsb) Counting of processed commands. | | | | | | | | | | | | | |
| Output status register | 30007 | No Function. | | | | | | | | | | | | | |
| | | Bit 7 _(msb) No function. ... Bit 2 No function. Bit 1 Digital output 2 status (0 = OFF; 1 = ON). Bit 0 _(lsb) Digital output 1 status (0 = OFF; 1 = ON). | | | | | | | | | | | | | |
| Selected page | 30008 | Shows the value of the selected page (3001). | | | | | | | | | | | | | |
| μV | 30009 | μV value. | | | | | | | | | | | | | |

15.2 MODBUS TCP REGISTERS FOR COMMAND SENDING

| Data | Register | DESCRIPTION | | | | | | | | | | | | | | | | | | |
|--------------------|-------------------------------|---|------------------------|---------|--------|------------|--------|---------------|--------|------|--------|-------------|--------|--------------------|--------|--------------------|--------|------------------------|--------|-------------------------------|
| <i>Command</i> | 40001 | Main available commands: | | | | | | | | | | | | | | | | | | |
| | | <table border="1"> <thead> <tr> <th>Value</th> <th>Command</th> </tr> </thead> <tbody> <tr> <td>00 Hex</td> <td>No command</td> </tr> <tr> <td>01 Hex</td> <td>Scale zeroing</td> </tr> <tr> <td>02 Hex</td> <td>Tare</td> </tr> <tr> <td>03 Hex</td> <td>Preset Tare</td> </tr> <tr> <td>0A Hex</td> <td>Setpoint 1 setting</td> </tr> <tr> <td>0B Hex</td> <td>Setpoint 2 setting</td> </tr> <tr> <td>19 Hex</td> <td>Digital output setting</td> </tr> <tr> <td>22 Hex</td> <td>Reboot the weight transmitter</td> </tr> </tbody> </table> | Value | Command | 00 Hex | No command | 01 Hex | Scale zeroing | 02 Hex | Tare | 03 Hex | Preset Tare | 0A Hex | Setpoint 1 setting | 0B Hex | Setpoint 2 setting | 19 Hex | Digital output setting | 22 Hex | Reboot the weight transmitter |
| | | Value | Command | | | | | | | | | | | | | | | | | |
| | | 00 Hex | No command | | | | | | | | | | | | | | | | | |
| | | 01 Hex | Scale zeroing | | | | | | | | | | | | | | | | | |
| | | 02 Hex | Tare | | | | | | | | | | | | | | | | | |
| | | 03 Hex | Preset Tare | | | | | | | | | | | | | | | | | |
| | | 0A Hex | Setpoint 1 setting | | | | | | | | | | | | | | | | | |
| | | 0B Hex | Setpoint 2 setting | | | | | | | | | | | | | | | | | |
| | | 19 Hex | Digital output setting | | | | | | | | | | | | | | | | | |
| 22 Hex | Reboot the weight transmitter | | | | | | | | | | | | | | | | | | | |
| <i>Parameter 1</i> | 40002 (H) | First parameter of the command. Parameter is always expressed in absolute mode (no decimals, no sign). | | | | | | | | | | | | | | | | | | |
| | 40003 (L) | | | | | | | | | | | | | | | | | | | |
| <i>Parameter 2</i> | 40004 (H) | Second parameter of the command. Parameter is always expressed in absolute mode (no decimals, no sign). | | | | | | | | | | | | | | | | | | |
| | 40005 (L) | | | | | | | | | | | | | | | | | | | |
| | 40006 | Used in advanced configuration, refer to the complete Fieldbus manual for further information. | | | | | | | | | | | | | | | | | | |
| | ... | | | | | | | | | | | | | | | | | | | |
| | 40016 | | | | | | | | | | | | | | | | | | | |

EXAMPLE 1

For zeroing the weight on the scale:

2. Set the command in byte 2

| Byte | Value |
|------|--------|
| 1 | 00 Hex |
| 2 | 01 Hex |

EXAMPLE 2

For setting a preset tare of 1000 lb:

1. Set the tare value in parameter 1 (byte 3, 4, 5, 6)
2. Set the command in byte 2

| Byte | Value |
|--------------------|--------|
| 1 | 00 Hex |
| 2 | 03 Hex |
| 3 _(MSB) | 00 Hex |
| 4 | 00 Hex |
| 5 | 03 Hex |
| 6 _(LSB) | E8 Hex |



© Rice Lake Weighing Systems Content subject to change without notice.

230 W. Coleman St. • Rice Lake, WI 54868 • USA USA: 800-472-6703 • International: +1-715-234-9171