

# SCT-20 Series

Signal Conditioning Transmitter/Indicator

## Technical Manual

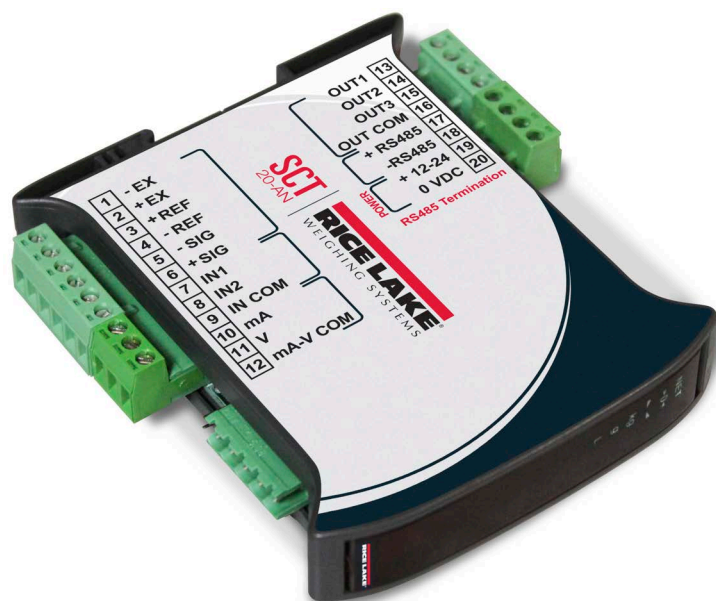

© Rice Lake Weighing Systems. All rights reserved.

Rice Lake Weighing Systems® is a registered trademark of  
Rice Lake Weighing Systems.

All other brand or product names within this publication are trademarks or  
registered trademarks of their respective companies.

All information contained within this publication is, to the best of our knowledge, complete and  
accurate at the time of publication. Rice Lake Weighing Systems reserves the right to make  
changes to the technology, features, specifications and design of the equipment without notice.

The most current version of this publication, software, firmware and all other product  
updates can be found on our website:

[www.ricelake.com](http://www.ricelake.com)

# Revision History

This section tracks and describes manual revisions for awareness of major updates.

Revision	Date	Description
I	December 9, 2022	Revision History Established; Instructions for opening unit in order to close jumper for legally relevant features; Updated Modbus-TCP setting; Merged NTEP information from SCT-20 Series Technical Manual (PN 131521); Removed Single Port EtherNet/IP Interface configuration as model is discontinued
J	April 26, 2023	Updated Legal for Trade menu parameters; Firmware version 1.0
K	June 6, 2023	Updated compatibility
L	March 21, 2025	Added battery disposal information for CE compliance

Table i. Revision Letter History



Technical training seminars are available through Rice Lake Weighing Systems. Course descriptions and dates can be viewed at [www.ricelake.com/training](http://www.ricelake.com/training) or obtained by calling 715-234-9171 and asking for the training department.

# Contents

<b>1.0 Introduction</b> .....	<b>7</b>
1.1 Safety .....	7
1.2 Disposal .....	8
1.3 FCC Compliance .....	8
1.4 Equipment Recommendations .....	8
1.5 Installation Guidelines .....	8
1.6 Weighing Instrument Installation .....	9
1.6.1 Load Cell Installation .....	9
1.7 Load Cells .....	11
1.7.1 Load Cell Input Test (Quick Access) .....	11
1.7.2 Load Cell Testing .....	11
1.8 Connectivity .....	11
1.9 Features of the SCT Weight Transmitter .....	12
1.10 Electrical Connections .....	13
1.11 LED Functions .....	14
1.12 Key Functions .....	15
1.13 Instrument Commissioning .....	16
<b>2.0 Configuration</b> .....	<b>17</b>
2.1 Access to CPU Board .....	17
2.2 Scale Menu .....	19
2.2.1 Legal for Trade Mode .....	21
2.2.2 Non-Legal for Trade .....	24
2.2.3 Zero Setting .....	27
2.2.4 Zero Value Manual Entry .....	27
2.2.5 Weight (Span) Calibration (with Test Weights) .....	27
2.2.6 Setting Units of Measure .....	28
2.2.7 Display Coefficient .....	29
2.3 Filter On The Weight .....	29
2.4 Zero Parameters .....	30
2.5 Serial Communication Settings .....	31
2.5.1 RS-485 Serial Communication .....	33
2.6 DeviceNet™ Settings .....	34
2.7 Analog Output .....	34
2.7.1 Soldered Jumper .....	35
2.7.2 Analog Output Type Scale Corrections .....	35
2.8 PROFIBUS Settings .....	35
2.9 EtherNet/IP™ Settings .....	36
2.10 Ethernet TCP/IP Settings .....	37
2.11 Outputs And Inputs Configuration .....	39
2.12 Test .....	40
2.13 Setpoints Programming .....	41
2.14 Reserved For The Installer .....	41
2.14.1 Menu Locking .....	41
2.14.2 Menu Unlocking .....	41
2.14.3 Temporary Menu Unlocking .....	41
2.14.4 Default Scale .....	42
2.14.5 Program Selection - Reverse .....	42



Rice Lake continually offers web-based video training on a growing selection of product-related topics at no cost. Visit [www.ricelake.com/webinars](http://www.ricelake.com/webinars)

2.14.6	Program Selection (Legal for Trade)	42
2.14.7	Program Selection (Non-Legal for Trade)	42
2.14.8	Keypad Or Display Locking	43
<b>3.0</b>	<b>Operation</b>	<b>44</b>
3.1	Semi-automatic Tare (Net/Gross)	44
3.2	Preset Tare (Subtractive Tare Device)	44
3.3	Semi-automatic Zero (Weight Zero-setting For Small Variations)	44
3.4	Peak	44
3.5	Info Menu	45
3.6	Alarms	45
3.7	DeviceNet	46
3.8	PROFIBUS	48
3.8.1	Real Calibration Commands (With Sample Weight)	52
3.9	EtherNet/IP™	52
3.9.1	Instrument Setup	52
3.9.2	Dual Port EtherNet/IP Interface	53
3.10	Ethernet TCP/IP	57
3.11	Modbus-TCP	59
3.11.1	SCT-20/SCT-40 Modbus-TCP Setup	59
3.11.2	Set IP Address with Lantronix Software	59
3.11.3	Set IP Address Via Telnet	61
3.12	Modbus-RTU Protocol	61
3.12.1	Access to Legally Relevant Parameters Commands	65
3.13	ASCII Bidirectional Protocol	67
3.14	Fast Continuous Transmission Protocol	71
3.15	Continuous Transmission Protocol	72
3.16	Interface to Remote Display	73
3.17	Communication Examples	73
<b>4.0</b>	<b>Compliance</b>	<b>76</b>
<b>5.0</b>	<b>Specifications</b>	<b>78</b>



Technical training seminars are available through Rice Lake Weighing Systems. Course descriptions and dates can be viewed at [www.ricelake.com/training](http://www.ricelake.com/training) or obtained by calling 715-234-9171 and asking for the training department.



*Rice Lake continually offers web-based video training on a growing selection of product-related topics at no cost. Visit [www.ricelake.com/webinars](http://www.ricelake.com/webinars)*

# 1.0 Introduction

This manual is intended for use by service technicians responsible for installing and servicing SCT-20 Series units.



Manuals are available from Rice Lake Weighing Systems at [www.ricelake.com/manuals](http://www.ricelake.com/manuals)

Warranty information is available at [www.ricelake.com/warranties](http://www.ricelake.com/warranties)

## 1.1 Safety

### Safety Definitions:



**DANGER:** Indicates an imminently hazardous situation that, if not avoided, will result in death or serious injury. Includes hazards that are exposed when guards are removed.



**WARNING:** Indicates a potentially hazardous situation that, if not avoided, could result in serious injury or death. Includes hazards that are exposed when guards are removed.



**CAUTION:** Indicates a potentially hazardous situation that, if not avoided, could result in minor or moderate injury.



**IMPORTANT:** Indicates information about procedures that, if not observed, could result in damage to equipment or corruption to and loss of data.

### General Safety

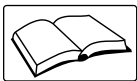

**Do not operate or work on this equipment unless this manual has been read and all instructions are understood. Failure to follow the instructions or heed the warnings could result in injury or death. Contact any Rice Lake Weighing Systems dealer for replacement manuals.**



#### **WARNING**

**Failure to heed could result in serious injury or death.**

**Risk of electrical shock. There are no user serviceable parts. Refer to qualified service personnel for service.**

**The unit has no power switch, to completely remove DC power from the unit, disconnect the DC power cable from the main socket.**

**For pluggable equipment the socket outlet must be installed near the equipment and be easily accessible.**

**Always disconnect from main power before performing any work on the device.**

**Do not allow minors (children) or inexperienced persons to operate this unit.**

**Do not operate without all shields and guards in place.**

**Do not use for purposes other than weighing applications.**

**Do not place fingers into slots or possible pinch points.**

**Do not use this product if any of the components are cracked.**

**Do not make alterations or modifications to the unit.**

**Do not remove or obscure warning labels.**

**Do not use near water.**

## 1.2 Disposal



### Product Disposal

The product must be brought to appropriate separate waste collection centers at the end of its life cycle.

Proper separate collection to recycle the product helps prevent possible negative effects on the environment and to health, and promotes the recycling of the materials. Users who dispose of the product illegally shall face administrative sanctions as provided by law.

### Battery Disposal

Dispose of batteries at appropriate waste collection centers at the end of their life cycle in accordance with local laws and regulations. Batteries and rechargeable batteries may contain harmful substances that should not be disposed of in household waste. Batteries may contain harmful substances including but not limited to: cadmium (Cd), lithium (Li), mercury (Hg) or lead (Pb). Users who dispose of batteries illegally shall face administrative sanctions as provided by law.



**WARNING:** Risk of fire and explosion. Do not burn, crush, disassemble or short-circuit lithium batteries.

## 1.3 FCC Compliance

### United States

This equipment has been tested and found to comply with the limits for a Class A digital device, pursuant to Part 15 of the FCC Rules. These limits are designed to provide reasonable protection against harmful interference when the equipment is operated in a commercial environment. This equipment generates, uses and can radiate radio frequency energy and, if not installed and used in accordance with the instruction manual, may cause harmful interference to radio communications. Operation of this equipment in a residential area is likely to cause harmful interference in which case the user will be required to correct the interference at his own expense.

### Canada

This digital apparatus does not exceed the Class A limits for radio noise emissions from digital apparatus set out in the Radio Interference Regulations of the Canadian Department of Communications.

Le présent appareil numérique n'émet pas de bruits radioélectriques dépassant les limites applicables aux appareils numériques de la Class A prescrites dans le Règlement sur le brouillage radioélectrique édicté par le ministère des Communications du Canada.

## 1.4 Equipment Recommendations



**IMPORTANT:** Failure to follow the installation recommendations is considered a misuse of the equipment.

### To Avoid Equipment Damage:

- \* Keep away from heat sources and direct sunlight.
- \* Protect the instrument from rain.
- \* Do not wash, dip in water or spill liquid on the instrument.
- \* Do not use solvents to clean the instrument.
- \* Do not install in areas subject to explosion hazard.

## 1.5 Installation Guidelines



**IMPORTANT:** If the unit gets too hot, it can stop communicating.

When the SCT-20 is installed inside of the electrical panel, it is recommended that the units be installed vertically to a horizontal DIN rail. This minimizes heat buildup from multiple units being stacked and also enables optimal ventilation through the unit. If possible, it is recommended that the unit be installed towards the bottom of a panel to avoid the warmest parts of the panel. If panel size is small, some air circulation may be required.



## 1.6 Weighing Instrument Installation

The terminals to be connected to ground, as indicated on the SCT Weight Transmitter wiring guide, must have the same potential as the scale structure ground. If unable to ensure this condition, connect a ground wire between the SCT Weight Transmitter and the scale structure.

The load cell cable must be run separately to the SCT Weight Transmitter input and not share a conduit with other cables. A shielded connection must be continuous without a splice.

Use RC filters (quencharcs) on the instrument-driven solenoid valve and remote control switch coils. To avoid electrical noise in the SCT Weight Transmitter panel, use special filters or sheet metal partitions to isolate. The panel installer must provide electrical protection for the instruments (fuses, door lock switch, etc.). It is recommended to leave the equipment powered on at all times to prevent the formation of condensation.

Maximum Cable Lengths:

- RS-485: 1000 meters with AWG24, shielded and twisted cables
- RS-232: 15 meters for baud rates up to 19200

### 1.6.1 Load Cell Installation

The load cells must be placed on rigid, stable structures within 0.5% of plumb and level. It is important to use the mounting modules for load cells to compensate for misalignment of the support surfaces.

Use waterproof sheaths and joints in order to protect the load cell cables.

#### Mechanical Restraints

When pipes are present, the use of hoses and flexible couplings and rubber skirted joints is recommended. In the event of rigid conduit and pipes, place the pipe support or anchor bracket as far as possible from the weighed structure (at a distance at least 40 times the diameter of the pipe).

#### Welding

Avoid welding with the load cells already installed. If this cannot be avoided, place the welder ground clamp close to the required welding point to prevent sending current through the load cell body.

#### Windy Conditions - Shocks - Vibrations

The use of weigh modules is strongly recommended for all load cells to compensate for misalignment of the support surfaces. The system designer must ensure that the scale is protected against lateral shifting and tipping relating to shocks and vibration, windy conditions, seismic conditions and the stability of the support structure.

#### Weighed Structure Grounding

Using a 10 gauge solid or braided wire or braided grounding strap, connect the load cell upper support plate with the lower support plate, then connect all the lower plates to a single earth ground. Once installed, accumulated electrostatic charges are discharged to the ground without going through or damaging the load cells. Failure to implement a proper grounding system may not affect the operation of the weighing system; however, this does not rule out the possibility that the cells and connected SCT Weight Transmitter may become damaged in the future. Do not ground using metal parts contained in the weighed structure.

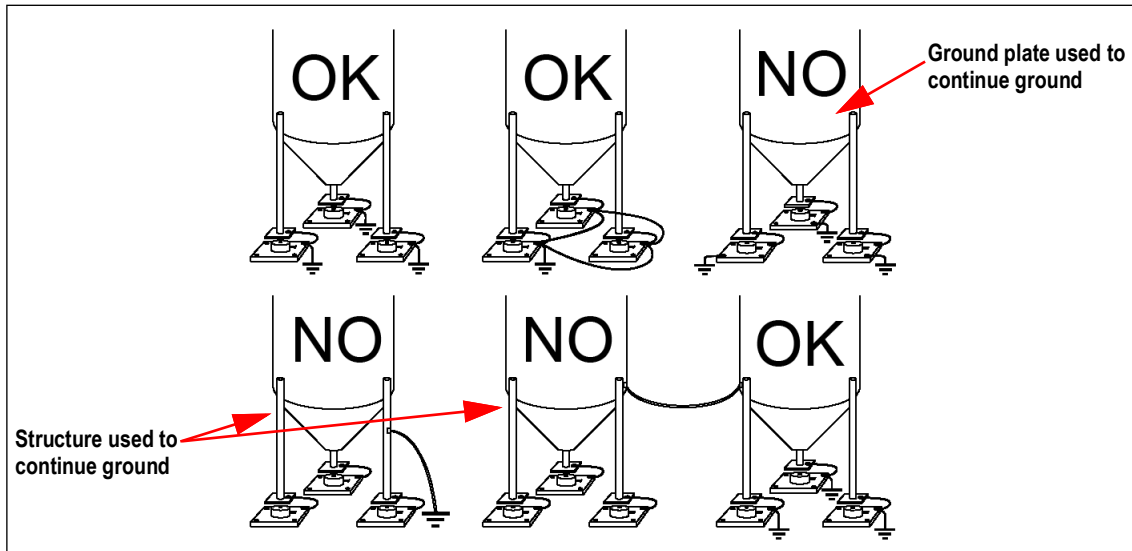

Figure 1-1. Installation Recommendations

## 1.7 Load Cells

### 1.7.1 Load Cell Input Test (Quick Access)

1. From the weight display, press ▲ for three seconds.  $nV-CELL$  is displayed.
2. Press ←. The response signal of the load cell is displayed, expressed in mV with four decimals.
3. Press ✕ three times to exit test mode.

### 1.7.2 Load Cell Testing

#### Load Cell Resistance Measurement (Use A Digital Multimeter)

- Disconnect the load cells from the instrument and check that there is no moisture in the load cell junction box caused by condensation or water infiltration. If so, drain the system or replace it if necessary.
- The value between the positive signal wire and the negative signal wire must be equal or similar to the one indicated in the load cell data sheet (output resistance).
- The value between the positive excitation wire and the negative excitation wire must be equal or similar to the one indicated in the load cell data sheet (input resistance).
- The insulation value between the shield and any other load cell wire and between any other load cell wire and the body of the load cell must be higher than 20 Mohm (megohms).

#### Load Cell Voltage Measurement (Use A Digital Multimeter)

- Remove the weight of the scale from the load cell to be tested.
- Make sure that the excitation wire of the load cell connected to the instrument is 5 VDC  $\pm 3$  percent.
- Measure the millivolt signal between the positive and the negative signal wires by directly connecting them to the multi-meter. Make sure it reads between 0 and 0.5 mV.
- Apply load to the load cell and make sure that there is a signal increment.



**IMPORTANT:** If one of the above conditions is not met, please contact Rice Lake Weighing Systems Customer Support for assistance.

## 1.8 Connectivity

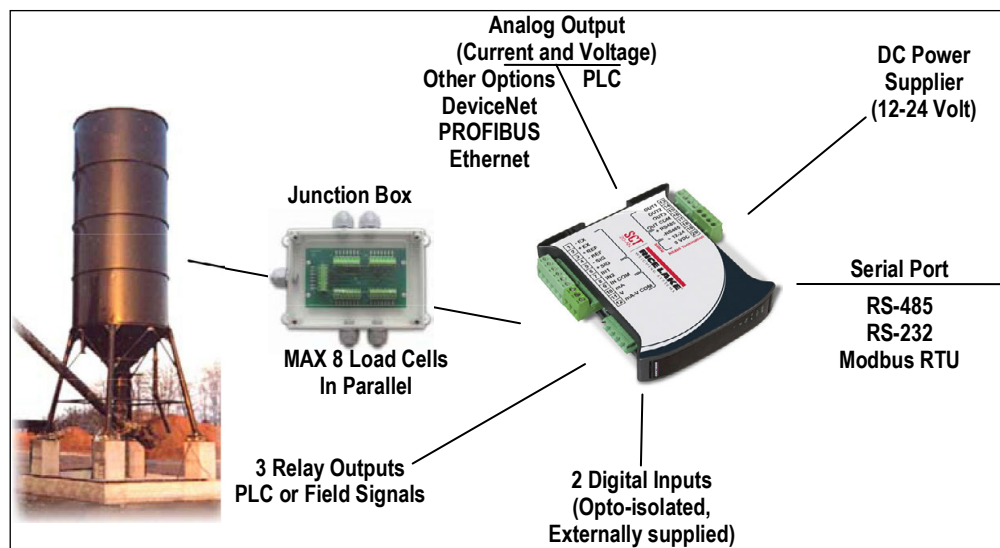

Figure 1-2. Connectivity

## 1.9 Features of the SCT Weight Transmitter

- Weight indicator and transmitter for Omega/DIN rail mounting suitable for back panel; space saving vertical shape.
- Six-digit semi alphanumeric display (18 mm h), 7 segment.
- Four-key keyboard. Dimensions: 25 x 115 x 120 mm.
- Displays the gross weight; with an external contact capable of remote zeroing and gross/net switching.
- Peak weight function.
- Analog Output Option - Transmits the gross or net weight via opto-isolated analog output 16 bit, current 0-20 mA, 4-20 mA or voltage 0-10V, 0-5V ( $\pm 0V$  /  $\pm 5V$  by closing a soldered in jumper).

The **DeviceNet™ Option** has a DeviceNet DP V0 Source port that allows the device to exchange the main system parameters with a DeviceNet primary.

The **PROFIBUS Option** has a PROFIBUS-DP V0 Source port that allows the device to exchange the main system parameters with a PROFIBUS primary.

The **Ethernet Option** has an EtherNet/IP™ device port that allows the device to exchange the main system parameters with an EtherNet/IP scanner.

The **Modbus-TCP Option** has a Modbus-TCP device port that allows the device to exchange the main system parameters with a Modbus-TCP primary.

The SCT Weight Transmitter transmits the gross or net weight via RS-485 serial port, by means of protocols:

- Modbus RTU
- ASCII bidirectional protocol
- Continuous transmission

## 1.10 Electrical Connections

### Basic Information

- It is recommended that the negative side of the power supply be grounded.
- It is possible to power up to eight 350 ohm load cells or sixteen 700 ohm load cells.
- For 4-wire load cells, make a jumper between EX- and REF- and between EX+ and REF+.
- Connect terminal 0 VDC to the RS-485 common when interfacing to A/C powered equipment so that there is an opto-isolated RS-485 connection.
- In the event of an RS-485 network with several devices, it is recommended to activate the 120 ohm termination resistance on the two devices located at the ends of the network. See [Section 2.5.1 on page 33](#).

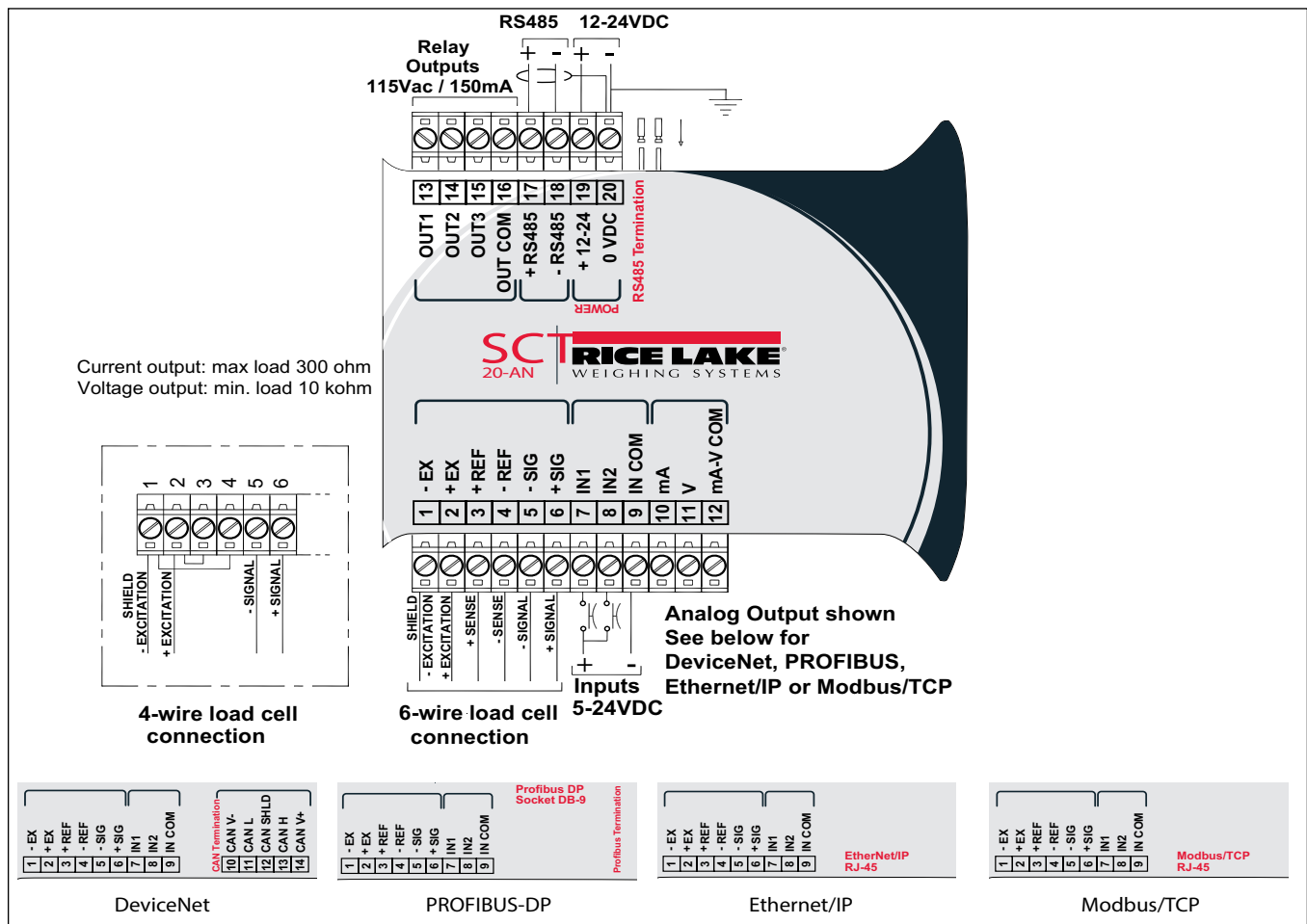

Figure 1-3. Wiring Diagram

**Three outputs:** configurable setpoints or remote output management via protocol.

**Two inputs:** default of **SEMI-AUTOMATIC ZERO** input 1; **NET/GROSS** input 2. See [Section 2.11 on page 39](#).

## 1.11 LED Functions



Figure 1-4. Display

LED	Main Function	Secondary Function *
NET	Net weight LED	None
→0←	Zero LED (deviation from zero not more than +/- 0.25 divisions)	LED lit: output 3 closed
▲▲	Stability LED	LED lit: output 2 closed
kg	Unit of measure: kg	LED lit: output 1 closed
g	Unit of measure: g	LED lit: input 2 closed
L	Unit of measure: lb	LED lit: input 1 closed
To activate the secondary LED function, press and hold →←, then press ▲.		

Table 1-1. LED Functions

LED	Function
<b>DeviceNet Model LED Function</b>	
DeviceNet Status	Blinks quickly: DeviceNet OK
	Blinks slowly (about 0.5s): Initialization
	LED lighted: source not initialized
	LED off: DeviceNet KO
<b>PROFIBUS Model LED Function</b>	
PROFIBUS Status	Blinks quickly: PROFIBUS OK
	Blinks slowly (about 0.5s): PROFIBUS error
<b>EtherNet/IP Model LED Function</b>	
EtherNet/IP Status	Blinks quickly: Ethernet OK
	Blinks slowly (about 0.5s): EtherNet/IP KO
RJ45 Connector Left side [Link LED]	Off: no link
	Amber: 10 Mbps
	Green: 100 Mbps
RJ45 Connector Right side [Activity LED]	Off: no activity
	Amber: half duplex
	Green: full duplex
<b>Modbus-TCP Model LED Function</b>	
Modbus-TCP Status	Blinks quickly: Modbus-TCP OK
RJ45 Connector Left side [Link LED]	Off: no link
	Amber: 10 Mbps
	Green: 100 Mbps
RJ45 Connector Right side [Activity LED]	Off: no activity
	Amber: half duplex
	Green: full duplex

Table 1-2. Options LED Function

## 1.12 Key Functions



Figure 1-5. SCT Weight Transmitter Display and Keys

KEY	Short press in weigh mode	Long press (3 sec) in weigh mode	Function within Setup Menus
Escape	—	Zero Setting	Escape from a parameter or return to previous menu or operation mode.
Scroll/ Backspace	Captures Tare Gross → Net	Removes Tare Net → Gross	Move to the previous parameter in a level or scroll to the next digit in a parameter value.
Next/ Data Entry	Save to alibi memory (if present)	mV load cell test	Move to the next parameter in a level or increment a value in a parameter.
Enter	Setting setpoints and hysteresis	—	Move to next level of configuration or select and edit a parameter.
and	Enter configuration for setting general parameters (press and hold  then press  to enter setup menu).		
and	Setting preset tare (press and hold  then press  to enter setup menu).		

Table 1-3. Key Definitions



**NOTE:** The LEDs are activated in sequence to indicate that a setting and not a weight is being viewed.

After pressing the first digit flashes and can be edited.

For numeric entries, press to select desired digit, then press to increment the digit.

## 1.13 Instrument Commissioning

1. Plug power cord into an outlet to power on the indicator. The display shows in sequence:
  - 5<sub>u</sub> followed by the software code (5<sub>u</sub> 5)
  - r followed by the software version (r 1.04.01)
  - h<sub>u</sub> followed by the hardware code (h<sub>u</sub> 104)
  - The serial number (1005 15)
2. Check that the display shows the weight and that there is an increase in weight when loading the load cells. If there is not, check and verify the connections and correct positioning of the load cells.
3. Confirm that the SCT Weight Transmitter has been theoretically calibrated, the load cell's rated data is already entered and that the plant system identification tag is present on the instrument and on the cover.



**NOTE:** If the instrument has not been calibrated, follow the calibration instructions in [Section 2.2.1 on page 21](#) before proceeding to next step.

4. Reset to zero. See [Section 2.2.3 on page 27](#).
5. Check the calibration with test weights and correct the indicated weight if necessary. See [Section 2.2.5 on page 27](#).
6. Set the desired output type and the full scale value.
  - Analog Output Model ([Section 2.7 on page 34](#))
  - DeviceNet Model ([Section 2.6 on page 34](#))
  - Ethernet Model ([Section 2.9 on page 36](#))
  - PROFIBUS Model ([Section 2.8 on page 35](#))
  - Modbus-TCP ([Section 3.11 on page 59](#))
7. If using serial communication, set the related parameters. See [Section 2.5 on page 31](#).
8. If setpoints are used, set the required weight values and the relevant parameters. See [Section 2.11 on page 39](#) and [Section 2.13 on page 41](#).



## 2.0 Configuration

The SCT-20 is sealed with a self-destructive adhesive label (PN 162881) placed over the seam between the two halves of the indicator. The seal prevents the top and bottom half from being separated and prohibits access to the jumper as shown in [Figure 2-5 on page 18](#) from being moved.

The jumper is closed by default for all model shipping from Rice Lake Weighing Systems. With the jumper closed, the SCT-20 can be calibrated and configured. The jumper will need to be removed before the SCT-20 is sealed for Legal for Trade applications.



**NOTE:** SCT-20 is configured by default to Legal for Trade mode. See [Section 2.14.6 on page 42](#) to switch to non Legal for Trade mode.

*While the SCT-20 is in weigh mode, the LED annunciators continually scroll to show the jumper is in place.*

The SCT-20 packaging includes a self-destructive adhesive label. For Legal for Trade applications, a new self-destructive adhesive label (PN 162882) and SCT-20 Capacity label (PN 162881) are required after each calibration. To request a new one, reference the part numbers for each label that is needed for replacement.

### 2.1 Access to CPU Board

A small flat-head screwdriver is needed to access the interior of the SCT-20.

1. Remove the red, spring-loaded DIN latch located at the bottom of the module to the left of the DIN channel.
2. Wedge the small screwdriver under the latch in the interior of the unit while pressing toward the screwdriver.



**NOTE:** Take care to not lose the spring located underneath the tab as the latch detaches.

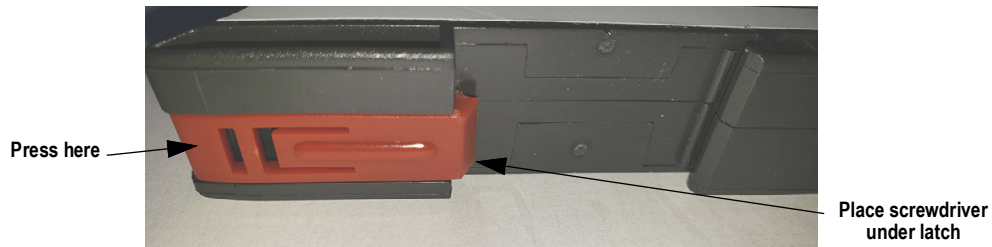

Figure 2-1. Remove DIN Latch

3. Lift the tab on the right side of the DIN channel with the small screwdriver while gently separating the case by hand.

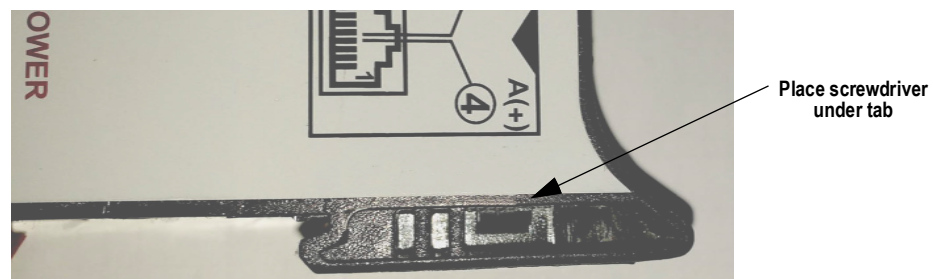

Figure 2-2. Lift Left Tab

4. Once case is slightly separated, insert the screwdriver in gap to gently increase the separation.

- Lift the tab on the left side of the DIN channel with a screwdriver to separate the case farther.

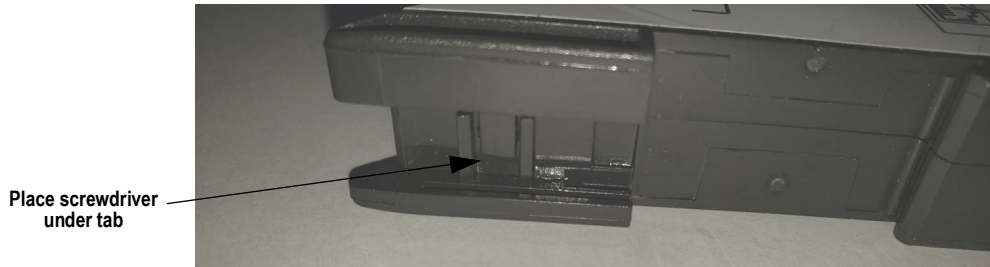

Figure 2-3. Lift Right Tab

- Lift up the tabs located on the side opposite the overlay with a screwdriver while pulling to remove the cover to gain access to the CPU board.



Figure 2-4. Lift Rear Tabs

- For Legal for Trade applications, the jumper will need to be removed before sealing the SCT-20. See Figure 2-5 for the jumper location.

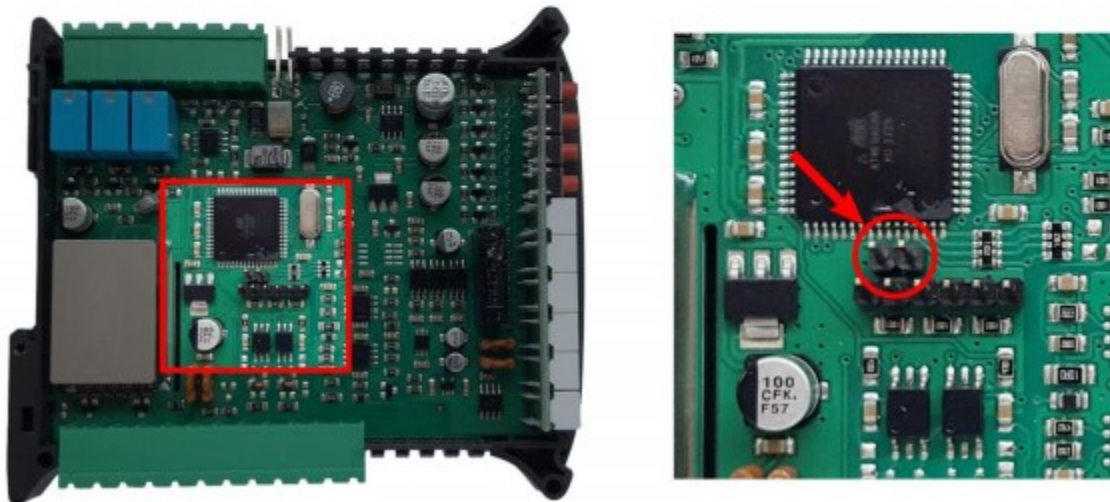

Figure 2-5. Jumper Location

- Assemble the two halves of the SCT-20 together.
- Place the red, spring-loaded DIN latch located at the bottom of the module to the left of the DIN channel.
- For Legal for Trade applications, set a new self-destructive adhesive label (PN 162882) over the seam between the two halves of the SCT-20.
- Set the SCT-20 Capacity Label (PN 162881) on the SCT-20.

## 2.2 Scale Menu

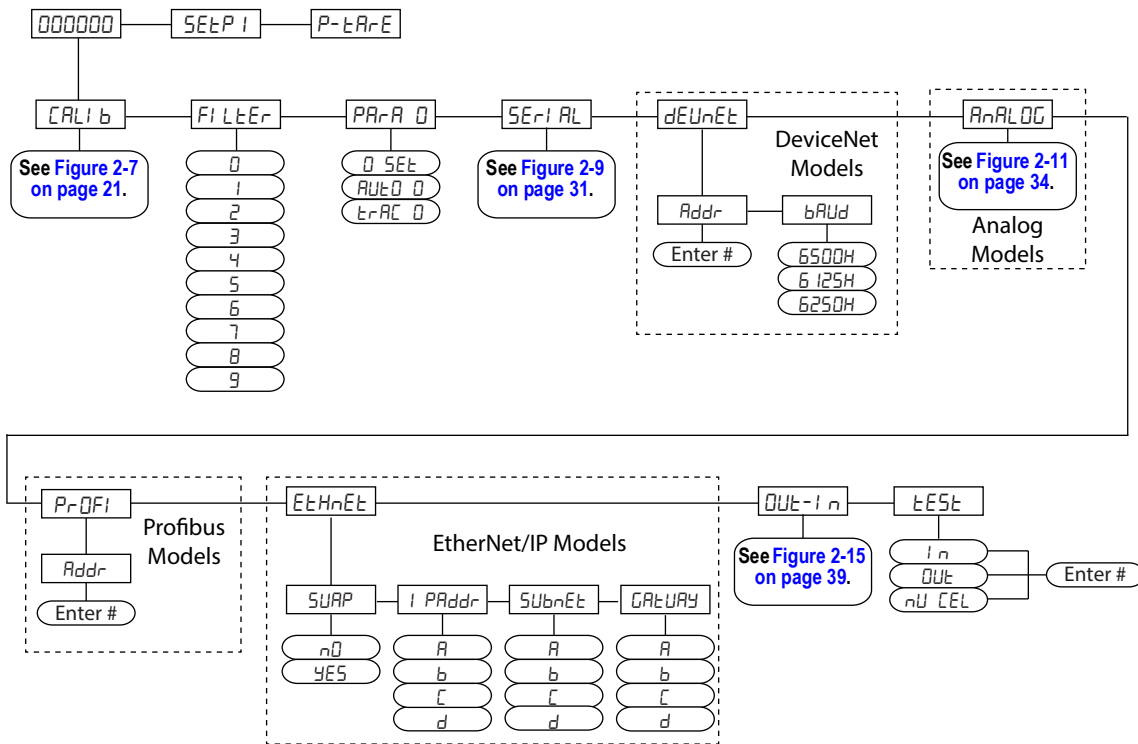

Figure 2-6. Scale Menu Structure

Parameter	Options	Description
CALib	FS-tED SEnSLb E nAh ZErd BE dht StAbLE un it un it C COEFF C CAL C USE tErCOr rELDAd SEL Ch EQuAL	Calibration (Section 2.2.1 on page 21)
FILtEr	0-9 4	Filter on the weight (Section 2.3 on page 29)
PARA 0	0 SEt AUt0 0 tRAC 0	Zero Parameters (Section 2.4 on page 30)

Table 2-1. Configuration Parameters

Parameter	Options	Description
SERIAL	rS-485 bAud Addr hErts dELAY PARity STOP	Serial Communications settings ( <a href="#">Section 2.5 on page 31</a> )
DeviceNet	Addr bAud	DeviceNet options for outputs and inputs configuration ( <a href="#">Section 2.11 on page 39</a> )
ANALOG	TYPE rDdE AnA 0 AnA FS COr 0 COr FS	Analog options for outputs and inputs configuration ( <a href="#">Section 2.11 on page 39</a> )
PROFIBUS	Addr	PROFIBUS settings ( <a href="#">Section 2.8 on page 35</a> )
EtherNet	SuAP I PAddr SubnEt GAtuAY	SCT-20 EtherNet/IP settings ( <a href="#">Section 2.9 on page 36</a> )
Out- in	Out 1 Out 2 Out 3 in 1 in 2	Outputs and Inputs configuration ( <a href="#">Section 2.11 on page 39</a> )
TEST	in Out nu-CEL	Test ( <a href="#">Section 2.12 on page 40</a> )

Table 2-1. Configuration Parameters (Continued)

## 2.2.1 Legal for Trade Mode

### 2.2.1.1 Calibration

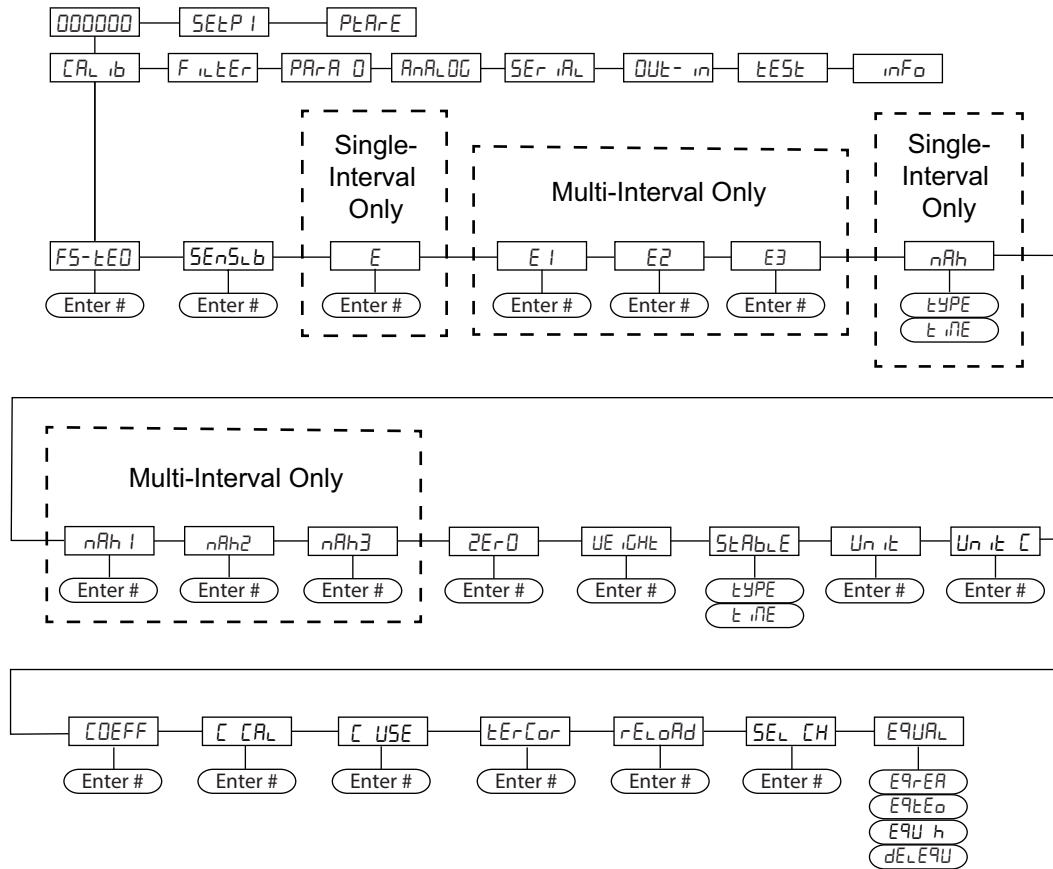

Figure 2-7. Calibration (Legal for Trade) Menu Structure

Parameter	Options	Description
FS-LEO	0 =dENO	System Full Scale – determined by multiplying one load cell capacity by the number of load cells used. Example of system full scale value calculation: 4 cells of 1000 kg ----> FULL SCALE = 1000 X 4 = 4000 <b>NOTE: The instrument is supplied with a theoretical full scale value dEN0 corresponding to 10000. To restore factory values, set 0 as full scale.</b>
SEN5Lb	0.50000- 7.00000 2.00000	Sensitivity – a load cell rated parameter expressed in mV/V; set the average sensitivity value indicated on the load cells Example of 4-cell system with sensitivity 2.00100, 2.00150, 2.00200, 2.00250; enter 2.00175, calculated as (2.00100 + 2.00150 + 2.00200 + 2.00250) / 4.
E E1 E2 E3	0.0001-100	Minimum weight increment value equal to 1/10000 of full scale. It can be changed and be variable between 0.0001 and 100 with x1 x2 x5 x10 increments.

Table 2-2. Calibration (Legal for Trade) Menu Parameters

Parameter	Options	Description
nAh nAh1 nAh2 nAh3	0-MAX	<p>Maximum capacity for single interval instruments. When the weight exceeds this value by 9 times E the following is displayed</p> <p>Max capacity of range 1 for multi-interval instruments. Weights above max1 displayed in E2 divisions.</p> <p>Max capacity of range 2 for multi-interval instruments. For instruments with 3 intervals, when weight exceeds MAX2, instrument displays weight in E3 divisions. For instruments with two divisions, error occurs when weight exceeds number by 9 x E2.</p> <p>Max capacity of range 3 for multi-interval instruments. Set to zero for two divisions; Error occurs when weight exceeds Max3 by 9 x E3.</p>
ZERO	0	<p>Zero – used to capture the deadload of the scale system; with the scale empty, the displayed value can be zeroed off; this menu can also be accessed directly from the weighing mode to compensate for zero changes or variations; Press ▲ to display the accumulated deadload weight that has been zeroed off.</p>
WEIGHT	0	<p>Weight (Span) Calibration – after the theoretical calibration is complete and zero is set, the calibration can be adjusted with actual test weights by changing the displayed value in this parameter</p> <p><b>NOTE: If changes are made to the theoretical Full Scale (FS-LE0), the Sensitivity (SENSIB) or Divisions (DIVISION) parameters, the Weight (Span) Calibration is canceled and the theoretical calibration is initiated and applied.</b></p> <p><b>NOTE: If the theoretical full scale (FS-LE0) and the capacity full scale (CAPACITY) are equal in Weight (Span) Calibration (WEIGHT), then the calibration currently in use is theoretical. If they are different, the calibration in use is the Weight (Span) Calibration based on calibration weights.</b></p> <p><b>NOTE: If changes are made to the theoretical full scale (FS-LE0), the capacity full scale (CAPACITY) or divisions (DIVISION) parameters, all the system's parameters containing a weight value will be set to default values (setpoints, hysteresis, etc.).</b></p>
STABLE	TYPE TIME	<p>Stability</p> <p>TYPE - select how the weight is considered stable</p> <ul style="list-style-type: none"> <li>- mode0 - the weight value must remain within the same division for a time greater than or equal to that specified in parameter time.</li> <li>- mode1 - the variation of the weight value must be less than or equal to a division for a time greater than or equal to that specified in parameter time.</li> </ul> <p>TIME - (from 0.1 to 3.0 ms; default: 1.0 s): time needed to consider the weight stable</p>
UNIT	g t lb Newton Liter Bar Atm PiecE neu-n hi lo-n other	<p>Unit of Measure – determines the unit of measure to be displayed and printed.</p> <p>See <a href="#">Section 2.2.6 on page 28</a> for unit descriptions.</p>
UNIT C	lb Newton Liter Bar Atm PiecE neu-n hi lo-n other	<p>Active Coefficient Unit - indicates the valid unit of measure when the coefficient function is active</p> <ul style="list-style-type: none"> <li>lb - pounds</li> <li>newton - newton</li> <li>litre - litres</li> <li>bar - bar</li> <li>atm - atmospheres</li> <li>piece - pieces</li> <li>neu-n - newton meters</li> <li>hi lo-n - kilogram meters</li> <li>other - other generic units of measure not included in the list</li> </ul>
COEFF	0-99.9999	Multiplier Value – if entered, displays an alternative unit of measure if digital input is set for COEFF and is in a closed state

Table 2-2. Calibration (Legal for Trade) Menu Parameters (Continued)

Parameter	Options	Description
C CAL	0-9.9999	If the instrument is not used at the same location where it is calibrated, it will be possible to fine-tune the calibration to adjust it to the final work seeing while the instrument is still in the calibration setting. set the gravity acceleration “g” values of both the instrument calibration area and the instrument work location  C Cal - g in the calibration area
C USE	0-9.99999	C Use - g in the work area
TEMPCOR	YES NO	Thermal Correction - corrects the weight value when the temperature is different from the ambient temperature to compensate slight variations which otherwise might occur
RELOAD	UNSTBL ZERO NONE	Reload - enables to choose which condition should be verified in order to restore the printing/storage function UNSTBL - the weight must become unstable and then stable again (default); ZERO - the weight must become equal to or less than zero NONE - the printing/storage function is always enabled
SEL CH	AUTO MANUAL	Select Channel - after performing the calibration and verifying that the system works properly, you can confirm the channels automatically detected by they instrument, in case of accidental interruption of the cable of one or more load cells, AUTO (default); MANUAL
EQUAL	EQUAL0 EQUAL1 EQUAL2	Equalization - Ensures equal weight readings on each load cell

Table 2-2. Calibration (Legal for Trade) Menu Parameters (Continued)



**NOTE:** To calibrate the instrument, the theoretical calibration (Section 2.2.2.3 on page 26) must be completed first. After theoretical calibration is set, the scale can be set with actual weights (Section 2.2.5 on page 27).

### 2.2.1.2 Theoretical Calibration

This function allows load cell rated values to be set. To perform the theoretical calibration set FS-LEO, SENSLb and E in sequence.

#### Single Interval Calibration

1. Press and hold **←**, then press **X**. CAL b is displayed.
2. Press **←**. FS-LEO is displayed.
3. Press **←**. SENSLb is displayed.
4. Press **←**. E is displayed.
5. Press **◀** or **▶** until desired display division size is displayed. Press **←**.

#### Multi-Interval Calibration

1. Press and hold **←**, then press **X**. CAL b is displayed.
2. Press **←**. FS-LEO is displayed.
3. Press **←**. SENSLb is displayed.
4. Press **←**. E 1 is displayed.
5. Press **◀** or **▶** until desired display division size is displayed. Press **←**.
6. Press **X** twice to exit setup menu.



**NOTE:** By modifying the theoretical full scale, the sensitivity or divisions, the Weight (Span) Calibration is canceled and only the theoretical calibration is considered valid.

If the theoretical full scale and the recalculated full scale in Weight (Span) calibration (Section 2.2.5 on page 27) are equal, this means that the calibration currently in use is theoretical calibration; if they are different, the calibration in use is the Weight (Span) Calibration based on test weights.

By modifying the theoretical full scale, the sensitivity or divisions and all the system's parameters containing a weight value will be set to default values (setpoints, hysteresis, etc.).

### 2.2.1.3 Maximum Capacity

Maximum capacity is the highest weight of live load/product that can be displayed. When the weight exceeds this value by 9 divisions, the following is displayed: -----. To disable this function, set to 0.

1. Press and hold **←**, then press **✕**. **CRALib** is displayed.
2. Press **←**, **F5-LEED** is displayed.
3. Press **◀** or **▶** until **nAh1** is displayed. Press **←**.
4. Press **◀** or **▶** until desired capacity is displayed. Press **←**.
5. Repeat for **nAh2** and **nAh3**.
6. Press **✕** twice to exit setup menu.

## 2.2.2 Non-Legal for Trade

### 2.2.2.1 Calibration

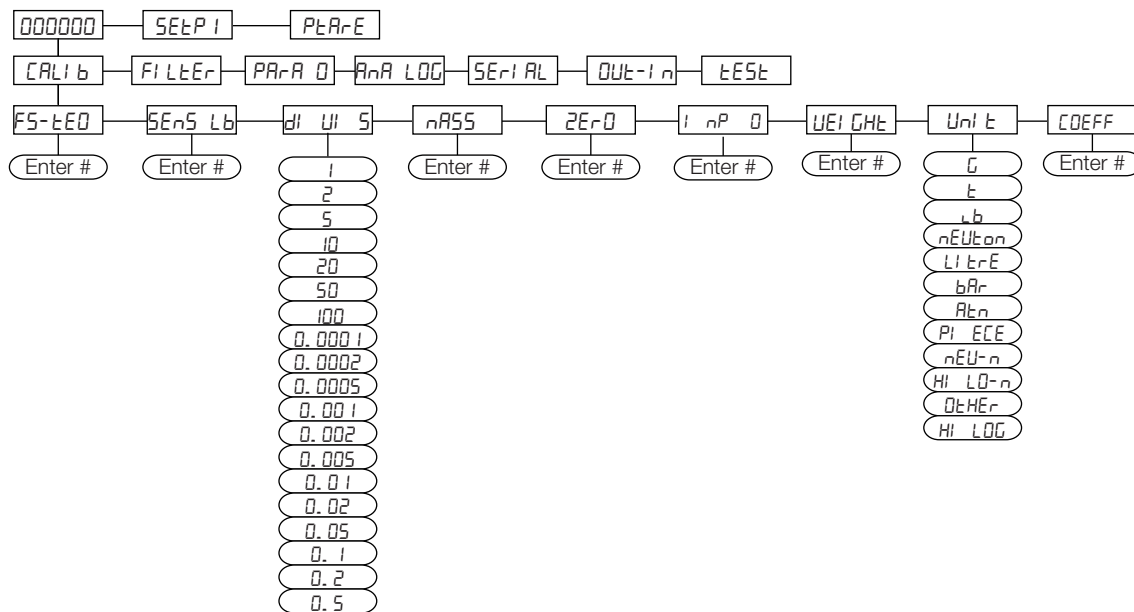

Figure 2-8. Calibration (non-Legal for Trade) Menu Structure

Parameter	Options	Description
F5-LEED	0 =dEnD	System Full Scale – determined by multiplying one load cell capacity by the number of load cells used. Example of system full scale value calculation: 4 cells of 1000 kg ----> FULL SCALE = 1000 X 4 = 4000 <b>NOTE: The instrument is supplied with a theoretical full scale value dEnD corresponding to 10000. To restore factory values, set 0 as full scale.</b>
SENS LB	0.50000- 7.00000 2.00000	Sensitivity – a load cell rated parameter expressed in mV/V; set the average sensitivity value indicated on the load cells Example of 4-cell system with sensitivity 2.00100, 2.00150, 2.00200, 2.00250; enter 2.00175, calculated as (2.00100 + 2.00150 + 2.00200 + 2.00250) / 4.

Table 2-3. Calibration (non-Legal for Trade) Menu Parameters



Parameter	Options	Description
divis	1 2 5 10 20 50 100 0.0001 0.0002 0.0005 0.001 0.002 0.005 0.01 0.02 0.05 0.1 0.2 0.5	Division (resolution) – is the weight increment (display division size) that the scale counts by. Settings: 0.0001 and 100 with x1 x2 x5 x10 increments.
max	0- max full scale	Maximum Capacity (Live Load/Product) – that can be displayed; when the weight exceeds this value by 9 divisions, dashes display, indicating overload; setting this value to 0 disables the over capacity function.
zero	0	Zero – used to capture the deadload of the scale system; with the scale empty, the displayed value can be zeroed off; this menu can also be accessed directly from the weighing mode to compensate for zero changes or variations; Press ▲ to display the accumulated deadload weight that has been zeroed off.
dead	0-999999 0	Estimated Dead Load Value – of the scale when a scale contains product that cannot be removed; the value entered is the dead load; this value is replaced if the zero function is performed
weight	0	Weight (Span) Calibration – after the theoretical calibration is complete and zero is set, the calibration can be adjusted with actual test weights by changing the displayed value in this parameter  <b>NOTE: If changes are made to the theoretical Full Scale (FS-LE0), the Sensitivity (SENS) or Divisions (divis) parameters, the Weight (Span) Calibration is canceled and the theoretical calibration is initiated and applied.</b>  <b>NOTE: If the theoretical full scale (FS-LE0) and the capacity full scale (max) are equal in Weight (Span) Calibration (weight), then the calibration currently in use is theoretical. If they are different, the calibration in use is the Weight (Span) Calibration based on calibration weights.</b>  <b>NOTE: If changes are made to the theoretical full scale (FS-LE0), the capacity full scale (max) or divisions (divis) parameters, all the system's parameters containing a weight value will be set to default values (setpoints, hysteresis, etc.).</b>
unit	g t lb metric li br bar Atn Pi ECE metric h, LQ-n OthEr h, LQG	Unit of Measure – determines the unit of measure to be displayed and printed. See Section 2.2.6 on page 28 for unit descriptions.
COEFF	0-99.9999	Multiplier Value – if entered, displays an alternative unit of measure if digital input is set for COEFF and is in a closed state

Table 2-3. Calibration (non-Legal for Trade) Menu Parameters (Continued)



**NOTE: To calibrate the instrument, the theoretical calibration (Section 2.2.2.3 on page 26) must be completed first. After theoretical calibration is set, the scale can be set with actual weights (Section 2.2.5 on page 27).**

### 2.2.2.2 Theoretical Calibration

This function allows load cell rated values to be set. To perform the theoretical calibration set  $F5-LE0$ ,  $SEN5$  and  $div5$  in sequence. See [Figure 2-8 on page 24](#).

1. Press and hold  $\leftarrow$ , then press  $\times$ .  $CAL$  is displayed.
2. Press  $\leftarrow$ .  $F5-LE0$  is displayed. Press  $\leftarrow$ .
3. Press  $\blacktriangleleft$  or  $\blacktriangleright$  until total load cell capacity (system full scale) is displayed. Press  $\leftarrow$ .
4. Press  $\blacktriangleleft$  or  $\blacktriangleright$  until  $SEN5$  is displayed. Press  $\leftarrow$ .
5. Press  $\blacktriangleleft$  or  $\blacktriangleright$  until desired load cell mV/V is displayed. Press  $\leftarrow$ .
6. Press  $\blacktriangleleft$  or  $\blacktriangleright$  until  $div5$  is displayed. Press  $\leftarrow$ .
7. Press  $\blacktriangleleft$  or  $\blacktriangleright$  until desired display division size is displayed. Press  $\leftarrow$ .
8. Press  $\times$  twice to exit setup menu.



**NOTE:** By modifying the theoretical full scale, the sensitivity or divisions, the Weight (Span) Calibration is canceled and only the theoretical calibration is considered valid.

*If the theoretical full scale and the recalculated full scale in Weight (Span) calibration ([Section 2.2.5 on page 27](#)) are equal, this means that the calibration currently in use is theoretical calibration; if they are different, the calibration in use is the Weight (Span) Calibration based on test weights.*

*By modifying the theoretical full scale, the sensitivity or divisions and all the system's parameters containing a weight value will be set to default values (setpoints, hysteresis, etc.).*

### 2.2.2.3 Maximum Capacity

Maximum capacity is the highest weight of live load/product that can be displayed. When the weight exceeds this value by 9 divisions, the following is displayed: -----. To disable this function, set to 0.

1. Press and hold  $\leftarrow$ , then press  $\times$ .  $CAL$  is displayed.
2. Press  $\leftarrow$ .  $F5-LE0$  is displayed.
3. Press  $\blacktriangleleft$  or  $\blacktriangleright$  until  $MAX$  is displayed. Press  $\leftarrow$ .
4. Press  $\blacktriangleleft$  or  $\blacktriangleright$  until desired capacity is displayed. Press  $\leftarrow$ .
5. Press  $\times$  twice to exit setup menu.

### 2.2.3 Zero Setting

Use Zero Setting to zero the scale after use or to compensate for variations due to environmental factors.

Perform this procedure after having set the theoretical calibration. See [Section 2.2.2.3 on page 26](#).



**NOTE:** This menu may also be accessed directly from the weight display. Press and hold **X** for three seconds.

1. Press and hold **←**, then press **X**. **CAL** is displayed.
2. Press **←**. **FS-LED** is displayed.
3. Press **◀** or **▶** until **ZERO** is displayed. Press **←**. The weight value to be set to zero is displayed and all of the LEDs are flashing.
4. Press **←**, the weight is set to zero and the value is stored to the permanent memory.
5. Press **X** twice to exit set-up menu.



**NOTE:** Press **▲** to display the accumulated deadload that has been zeroed off by the instrument, displaying the sum of all of the previous zero settings.

### 2.2.4 Zero Value Manual Entry



**IMPORTANT:** Perform this procedure only if it is not possible to zero off the scale structure, for example because it contains product that can not be unloaded.

Enter the estimated structured dead load value that would be zeroed.

1. Press and hold **←**, then press **X**. **CAL** is displayed.
2. Press **←**, **FS-LED** is displayed.
3. Press **◀** or **▶** until **INP** is displayed. Press **←**.
4. Press **◀** or **▶** until desired dead load value is displayed. Press **←**.
5. Press **X** twice to exit set-up menu.

### 2.2.5 Weight (Span) Calibration (with Test Weights)

After performing the theoretical calibration ([Section 2.2.2.3 on page 26](#)) and the Zero setting ([Section 2.2.3 on page 27](#)), this function allows calibration to be done using test weights of known value. If adjustment is required, change the displayed value to display the test weight value.

1. Load the test weight onto the scale, use as high of a percentage of the maximum quantity to be weighed as possible.
2. Press and hold **←**, then press **X**. **CAL** is displayed.
3. Press **←**. **FS-LED** is displayed.
4. Press **◀** or **▶** until **WEIGHT** is displayed.
5. Press **←**. The value of the weight currently on the system will be flashing on the display. All of the LEDs are off. (If adjustment is not required, skip to step 8.)
6. Adjust the value on display to match weight loaded on the scale if necessary, by pressing **◀** or **▶**. The LEDs will begin scrolling.
7. Press **←**, the new set weight is displayed with all the LEDs flashing.
8. Press **←**, **WEIGHT** will be displayed again.
9. Press **X** twice to exit set-up menu.

Example:

For a system of maximum capacity of 1000 kg and 1 kg division, two test weights are available, one 500 kg and one 300 kg. Load both weights onto the system and correct the indicated weight to 800. Now remove the 300 kg weight, the system must show 500; remove the 500 kg weight, too; the system must read zero. If this does not happen, it means that there is a mechanical problem affecting the system linearity.



**IMPORTANT:** Identify and correct any mechanical problems before repeating the procedure.



**NOTE:** If theoretical full scale and recalculated full scale in Weight (Span) Calibration are equal, it means that the theoretical calibration is currently in use; otherwise, the Weight (Span) Calibration based on test weights is in use.

If the correction made changes the previous full scale for more than 20%, all the parameters with settable weight values are reset to default values.

### Linearization Option On Max 5 Points:

It is possible to perform a linearization of the weight by performing the Weight (Span) Calibration (With Test Weights) with up to a maximum of five points, using five different test weights. The procedure ends by pressing **X** or after entering the fifth value. At this point it will no longer be possible to change the calibration value; a new Weight (Span) Calibration would need to be performed. To perform a new calibration, return to the weight display and then re-enter the calibration menu.

By pressing **▲** after having confirmed the test weight that has been set, the full scale displays the value of the maximum test weight entered and references the cell sensitivity set in the theoretical calibration (SENSE *b*).

### 2.2.6 Setting Units of Measure



**NOTE:** To access this menu item, a qualified access is required (see Section 3.12.1 on page 65).

1. Press and hold **←**, then press **X**. CAL *b* is displayed.
2. Press **←**, FS-*bED* is displayed.
3. Press **◀** or **▲** until unit is displayed. Press **←**.
4. Press **◀** or **▲** until desired unit is displayed. Press **←**.
5. Press **X** twice to exit set-up menu.

Unit Display	Description
KG	Kilograms
G	Grams
T	Tons*
Lb	Pounds
NEWTON	Newtons*
LITER	Liters*
BAR	Bars*
ATM	Atmospheres*
PIECE	Pieces*
NEWTM	Newton meters*
KG-M	Kilogram meters*
OTHER	Other generic units of measure not included on the list*

\* Indicates it is possible to set the display coefficient. To use DEFF it is necessary to enable it, closing the DEFF input. See Section 2.2.7.

Table 2-4. Units of Measure



**NOTE:** If the print function is enabled, the symbol of the selected unit of measure will be printed after the measured value.

## 2.2.7 Display Coefficient



**NOTE:** To access this menu item, a qualified access is required (see [Section 3.12.1 on page 65](#)). Coefficient will have different meanings according to the value set in `UNIT C` (the selected unit of measure).

By setting the coefficient, the display is changed accordingly.

If one of the inputs is set to `COEFF` mode ([Section 2.11 on page 39](#)) when the input is closed the value displayed will be modified according to the coefficient. When the input is opened the standard weight display will be restored.

1. Press and hold **←**, then press **✕** to enter set-up menu, `CAL lb` will be displayed.
2. Press **←**, `FS-LED` is displayed.
3. Press **◀** or **▶** until `COEFF` is displayed. Press **←**.
4. Press **◀** or **▶** until desired number is displayed. Press **←**.
5. Press **✕** twice to exit set-up menu.

Display	Definition	Display Coefficient
<code>lb</code>	pounds	The value set in <code>COEFF</code> will be multiplied by the weight value currently displayed.
<code>newton</code>	newton	The value set in <code>COEFF</code> will be multiplied by the weight value currently displayed.
<code>litres</code>	litres	In <code>COEFF</code> set the specific weight in kg/l, assuming that the system is calibrated in kg.
<code>bar</code>	bar	The value set in <code>COEFF</code> will be multiplied by the weight value currently displayed.
<code>atmospheres</code>	atmospheres	The value set in <code>COEFF</code> will be multiplied by the weight value currently displayed.
<code>pieces</code>	pieces	In <code>COEFF</code> set the weight of one piece.
<code>newton meters</code>	newton meters	The value set in <code>COEFF</code> will be multiplied by the weight value currently displayed.
<code>kilogram meters</code>	kilogram meters	The value set in <code>COEFF</code> will be multiplied by the weight value currently displayed.
<code>other units of measure not included list</code>	other units of measure not included list	The value set in <code>COEFF</code> will be multiplied by the weight value currently displayed.

Table 2-5. Display Coefficient

All other settings are expressed in weight value. To convert them to the new unit of measurement, perform a test where the values modified according to the coefficient have no legal value. When they are displayed, the active LEDs will flash to indicate that the displayed value is not a valid weight. Perform a weight (span) calibration for other units of measure to change the system calibration. The parameter `COEFF` must remain set to 1.0000.



**NOTE:** The values modified according to the coefficient have no legal value. When they are displayed, the active LEDs will flash to indicate that the displayed value is not a valid weight.

### Theoretical Calibration For Other Units Of Measure

Set in the parameter the `F.SCALE` value divided by the conversion coefficient from kg to the new unit of measure.

Example: The 4 load cells of 1000 kg are placed under a scale for olive oil, which has a specific gravity of 0.916 kg / l. Setting the  $F.SCALE = (4 \times 1000) / 0.916 = 4367$ , the system works in liters of olive oil. See [Section 2.2.6 on page 28](#).

### Weight (Span) Calibration For Other Units Of Measure

Load a known quantity of product litres on the scale (use as high a percentage of the maximum quantity to be weighed as possible) and enter in the parameter `WEIGHT`, the product loaded value in litres. See [Section 2.2.6 on page 28](#).

## 2.3 Filter On The Weight

The filtering selection is used to eliminate environment noise, and is typically a compromise between responsiveness and stability. The lower the number, the more responsive the display will be to weight changes. The filter is used to stabilize a weight as long as the variations are smaller than the corresponding Response Time. The filter setting is dependent on the type of application and the required update rate (see [Table 2-6](#)).

Setting the parameter allows a stable weight display to be obtained. To increase the effect (weight more stable), increase value.

1. Press and hold **←**, then press **✕**. `CAL lb` is displayed.
2. Press **◀** or **▶** until `FILTER` is displayed.

3. Press **←**. The currently programmed filter value is displayed.
4. Press **◀** or **▶** until desired filter value is displayed.
5. Press **←** to accept. The current weight will then display with all LEDs scrolling and the displayed stability can be verified.
  - If the stability is not satisfactory, press **✕** twice. This returns the indicator to the *FILTER* option and the filter may be modified again until an optimum result is achieved.
  - If the stability is satisfactory, press **←**. Do not proceed until **0** is displayed.
  - Press **✕** once to set the anti-peak filter.



**NOTE:** The anti-peak filter can only be set after the instrument is connected to a load cell. When the weight is stable, the anti-peak filter removes sudden weight fluctuations determined by the configured time (see [Table 2-6](#)), up to a maximum duration of one second.

6. Press **◀** or **▶** to display *Anti-Pk On* or *Anti-Pk Off* to set this filter on or off.
7. Press **←** to accept. *FILTER* is displayed.
8. Press **✕** to exit setup menu.

Filter Value	Response Time [ms]	Display and Serial Port Refresh Frequency [Hz]
0	12	300
1	150	100
2	260	50
3	425	25
4*	850	12.5
5	1700	12.5
6	2500	12.5
7	4000	10
8	6000	10
9	7000	5
Anti-peak	6	600

\* Indicates default value.

Table 2-6. Filter Values

## 2.4 Zero Parameters

1. Press and hold **←**, then press **✕**. *Zero* is displayed.
2. Press **◀** or **▶** until *Zero* is displayed. Press **←**.
3. Press **◀** or **▶** until desired parameter is displayed. See [Table 2-7](#).
4. Press **←**. The currently programmed value is displayed.
5. Press **◀** or **▶** until desired value is displayed. Press **←** to accept.
6. Press **✕** twice to exit set-up menu.

Parameter	Options	Description
<b>Zero</b>	0-max full scale 300* Considered decimals: 300 – 30.0 – 3.00 – 0.300	Maximum zero range Indicates the maximum weight value that can be zeroed off by external contact, keypad or serial protocol

Table 2-7. Zero Parameters

Parameter	Options	Description
Auto 0	0 - max 20% of full scale 0 *	Automatically zeros the scale at power-on If the weight value is lower than the value set in this parameter, the scale will zero itself provided the weight does not exceed the value in the 0 SET parameter. To disable this function set to 0.
TRAC 0	nOnE * 1-5	Zero tracking Automatically zeros the scale when within the range specified, as long as the weight is within the 0 SET parameter and the scale is at standstill for at least one second. To disable this function, set to none. <i>Example: if the parameter d i u i 5 is set to 5 and TRAC 0 is set to 2, the weight will be automatically set to zero for variations smaller than or equal to 10 (d i u i 5 H TRAC 0).</i>

\* Indicates default value.

Table 2-7. Zero Parameters (Continued)

## 2.5 Serial Communication Settings

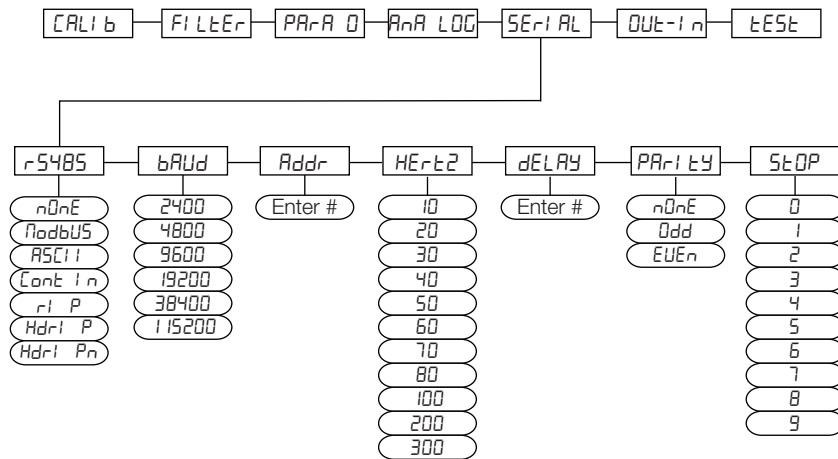

Figure 2-9. Serial Communications Menu Structure

Parameter	Options	Description
r5-485 (Communication Port)	nOnE	Disables any type of communication.
	MODBUS	MODBUS-RTU protocol; possible addresses: from 1 to 99 ( <a href="#">Section 3.12 on page 61</a> )
	ASCII	ASCII bidirectional protocol; possible addresses: from 1 to 99 ( <a href="#">Section 3.13 on page 67</a> ) NOdu6 NOdTd
	ContIn	Continuous weight transmission protocol ( <a href="#">Section 3.14 on page 71</a> ), at the frequency set in HERTZ parameter (from 10 to 300). <b>MOd t</b> set: PARITY = none STOP = 1 <b>MOd td</b> set: PARITY = none STOP = 1
	ri P	Continuous weight transmission protocol, streams net and gross (see <a href="#">Section 3.15</a> ) Set: BAUD = 9600 PARITY = none STOP = 1
	hdrI P	Continuous weight transmission protocol, streams net and gross including decimal. ( <a href="#">Section 3.15 on page 72</a> ) Set: BAUD = 9600 PARITY = none STOP = 1
	hdrI Pn	Continuous weight transmission protocol (see <a href="#">Section 3.15</a> ) Set: BAUD = 9600 PARITY = none STOP = 1 When the remote display is set to gross weight: - if the instrument displays the gross weight, the remote display shows the gross weight. - if the instrument shows the net weight the remote display shows the net weight alternated with the message <b>net</b>

Table 2-8. Serial Communications Menu Parameters

Parameter	Options	Description
<i>bAud</i>	2400 4800 9600** 19200 38400 115200	Transmission speed.
<i>Addr</i>	1-99 1*	Instruments address
<i>hertz</i>	10Hz** 20Hz 30Hz 40Hz 50Hz 60Hz 70Hz 80Hz 100Hz 200Hz 300Hz	Maximum Transmission Frequency – set when the <b>Cont in</b> transmission protocol is selected.  Max setting with min 2400 baud rate  Max setting with min 4800 baud rate  Max setting with min 9600 baud rate Max setting with min 19200 baud rate Max setting with min 38400 baud rate Max setting with min 38400 baud rate
<i>dELAY</i>	0-200 msec 0*	Delay in milliseconds which elapses before the instrument replies
<i>PARITY</i>	nOnE** EUEn Odd	parity none even parity odd parity
<i>STOP</i>	1** 2	Stop bit
* Indicates default value.		

Table 2-8. Serial Communications Menu Parameters (Continued)



### 2.5.1 RS-485 Serial Communication

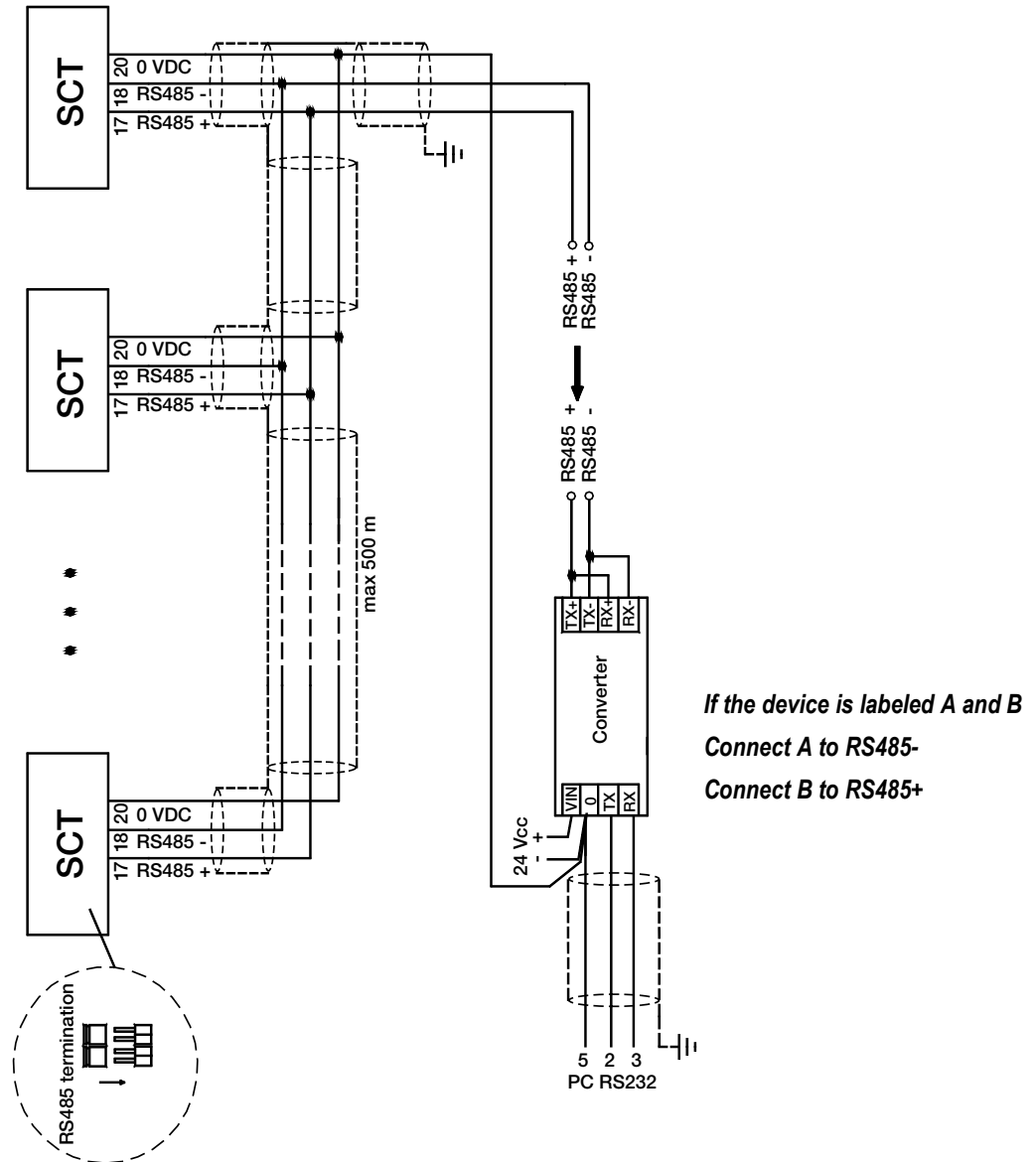

Figure 2-10. RS-485 Serial Communications

**NOTE:** If the RS-485 network exceeds 100 meters in length or a baud rate over 9600 is used, close the two jumpers, called RS-485 termination, to activate two 120 ohm terminating resistors between the '+' and '-' terminals of the line, on the terminal strip of the furthest instrument. Should there be different instruments or converters, refer to the specific manuals to determine whether it is necessary to connect the above-mentioned resistors.

#### Direct Connection Between RS-485 and RS-232 Without Converter

Since a two-wire RS-485 output may be used directly on the RS-232 input of a PC or remote display, it is possible to implement instrument connection to an RS-232 port in the following manner:

Instrument	RS-232
RS-485 -	RXD
RS-485 +	GND

Table 2-9. Connection Between RS-485 and RS-232

**NOTE:** This type of connection allows a single instrument to be used in one mode.

## 2.6 DeviceNet™ Settings

1. Press and hold **←** and **✕**. **CLib** is displayed.
2. Press **←** or **▲** until **dEUnEt** is displayed. Press **←**.
3. Press **←** or **▲** until desired parameter is displayed. Press **←**.
4. Press **←** or **▲** until desired value is displayed. Press **←**.
5. Press **✕** twice to exit set-up menu.

Parameter	Options	Description
Addr	1-63 1*	Set instrument address in the DeviceNet™ network.
bAud	6 125h 6250h 6500h*	Set instrument address in the DeviceNet™ network.

\* Indicates default value.

Table 2-10. DeviceNet Parameters

## 2.7 Analog Output

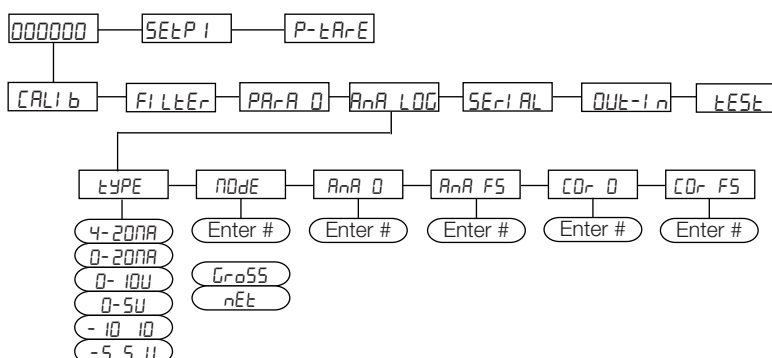

Figure 2-11. Analog Menu Structure

Parameter	Options	Description
tYPE	4-20 mA 0-20 mA 0-10 U 0-5 U -10 to 10 U -5 to 5 U	Select the analog output type.  See <a href="#">Section 2.7.1</a> for more information. See <a href="#">Section 2.7.1</a> for more information.
nDdE	Gross net	Select the mode to be tracked, gross or net. If the net function is not active, the analog output varies according to gross weight.
AnA 0	--	Set the weight value for the minimum analog output value.  <b>NOTE: Only set a value different from zero to limit the analog output range.</b> <i>Example: for a full scale value of 10000 kg, a 4 mA signal at 5000 kg is required, and 20 mA at 10000 kg, in this case, instead of zero, set 5000 kg.</i>
AnA FS	--	Set the weight value for the maximum analog output value; it must correspond to the value set in the PLC program (default: calibration full scale). <i>Example: if using a 4-20 mA output and in the PLC program a 20 mA = 8000 kg is desired, set the parameter to 8000.</i>
COr 0	--	Analog output correction to zero: if necessary adjust the analog output, allowing the PLC to indicate 0. The sign '-' can be set for the last digit on the left. <i>Example: for a 4-20 mA output and a minimum analog setting, the PLC or tester reads 4.1 mA. Set the parameter to 3.9 to obtain 4.0 on the PLC or tester. See Analog Output Type Scale Corrections for additional information.</i>

Table 2-11. Analog Menu Parameters

Parameter	Options	Description
$\llcorner$ $\text{F5}$	--	Full scale analog output correction: if necessary adjust the analog output, allowing the PLC to indicate the value set in the parameter. <i>Example: for a 4-20 mA output with the analog set to full scale and the PLC or tester reads 19.9 mA, set the parameter to 20.1 to obtain 20.0 on the PLC or tester. See Analog Output Type Scale Corrections for additional information.</i>

\* Indicates default value.

Table 2-11. Analog Menu Parameters (Continued)

### 2.7.1 Soldered Jumper

For the output -10 +10 V and -5 +5 V the soldered jumper (SW4) must be closed:

- Release the locking tabs, both sides, to open the enclosure.
- Locate the soldered jumper (SW4), on the circuit board. See Figure 2-12 on page 35.
- Close the jumper shorting the pads with a solder bridge.

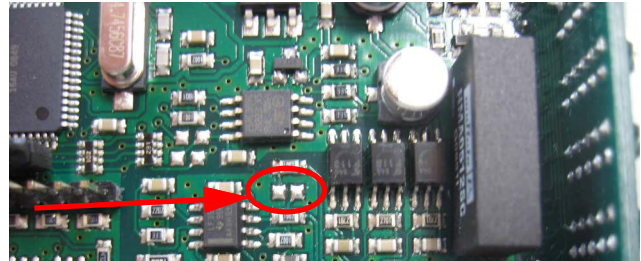

Figure 2-12. Soldered Jumper

### 2.7.2 Analog Output Type Scale Corrections

Minimum and maximum values which can be set for the zero and full scale corrections Refer to  $\llcorner$   $\text{D}$  and  $\llcorner$   $\text{F5}$ .

Analog Output Type	Minimum	Maximum
0-10 V	-0.15	10.2
0-5 V	-0.15	5.5
-10 +10 V	-10.3	10.2
-5 +5 V	-5.5	5.5
0-20 mA	-0.2	22
4-20 mA	-0.2	22

Table 2-12. Analog Output Scale Corrections



**NOTE:** The analog output may also be used in the opposite manner, where, the weight setting that corresponds to the analog zero ( $\text{AnA D}$ ) may be greater than the weight set for the analog full scale ( $\text{AnA F5}$ ). The analog output will increase towards full scale as the weight decreases; the analog output will decrease as the weight increases.

**Example:** analog output type having selected 0-10V

$\text{AnA D} = 10000$	$\text{AnA F5} = 0$
Weight = 0 kg	analog output = 10 V
Weight = 5000 kg	analog output = 5 V
Weight = 10000 kg	analog output = 0 V

## 2.8 PROFIBUS Settings

1. Press and hold  $\leftarrow$  and  $\times$ .  $\llcorner$   $\text{ib}$  is displayed.
2. Press  $\blacktriangleleft$  or  $\blacktriangleright$  until  $\text{PrDF}$  is displayed.
3. Press  $\leftarrow$   $\text{Addr}$  is displayed. Press  $\leftarrow$ .
4. Press  $\blacktriangleleft$  or  $\blacktriangleright$  until desired value is displayed. Press  $\leftarrow$ .
5. Press  $\times$  twice to exit set-up menu.

Parameter	Options	Description
$\text{Addr}$	1-99	Set instrument address in the PROFIBUS network.

Table 2-13. PROFIBUS Parameters

## 2.9 EtherNet/IP™ Settings

1. Press and hold **←** and **✕**. **CALib** is displayed.
2. Press **◀** or **▶** until **ETHER** is displayed. Press **←**.
3. Press **◀** or **▶** until desired parameter is displayed. Press **←**.
4. Press **◀** or **▶** until desired value is displayed. Press **←**.
5. Press **✕** twice to exit set-up menu.

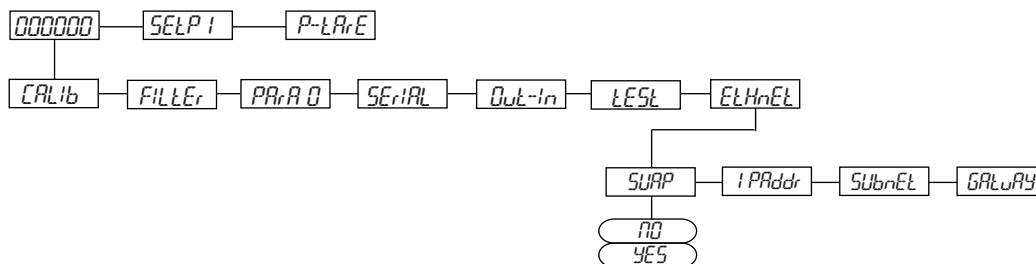

Figure 2-13. SCT-20 IP Menu Structure

Parameter	Options	Description
SWAP	no * Little Endian YES Big Endian	Allows selection of reading/writing of bytes.
IPAddr	A b C d 192.8.0.141*	Set IP address in the EtherNet/IP™ network.
Subnet	A b C d 255.255.255.0*	Set Subnet mask
GATEWAY	A b C d 192.8.0.111*	Set the Gateway address

\* Indicates default value.

Table 2-14. SCT-20 IP Menu Parameters

## 2.10 Ethernet TCP/IP Settings

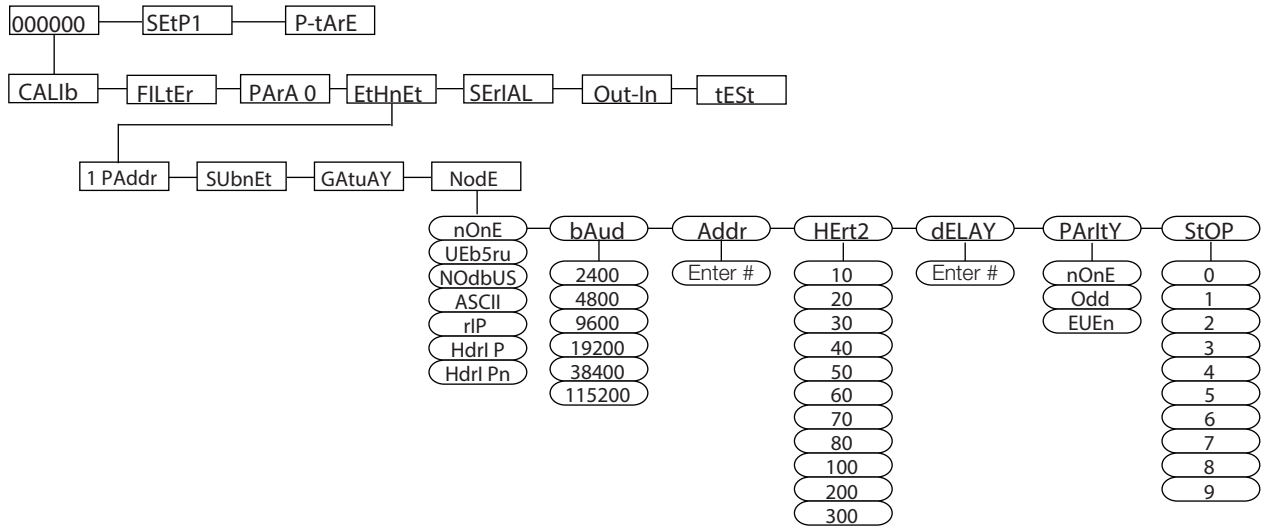

Figure 2-14. SCT-20 TCP/IP Menu Structure

Parameter	Options	Description
1 PAddr **	A-d 192 . 8 . 0 . 141 *	Set IP address in the EtherNet/IP™ network.
SubnEt **	A-d 255 . 255 . 255 . 0 *	Set Subnet mask.
GAtuAY **	A-d 192 . 8 . 0 . 111 *	Set the Gateway address.
nodE (Comm Port)	nOnE*	Disables any type of communication.
	UEb5ru	Web Server
	nOdbuS	MODBUS-RTU protocol; possible addresses: from 1 to 99 ( <a href="#">Section 3.12 on page 61</a> )
	ASC II	ASCII bidirectional protocol; possible addresses: from 1 to 99 ( <a href="#">Section 3.13 on page 67</a> ) <b>NOdU6-</b> NOd td
	COnt in	Continuous weight transmission protocol ( <a href="#">Section 3.14 on page 71</a> ), at the frequency set in HERTZ parameter (from 10 to 300). <b>NOd t</b> set: PARITY = none STOP = 1 <b>NOd td</b> set: PARITY = none STOP = 1
nodE (Continued)	r i P	Continuous weight transmission protocol, streams net and gross ( <a href="#">Section 3.15 on page 72</a> ) Set: BAUD = 9600 PARITY = none STOP = 1
	hdr l Pn	Continuous weight transmission protocol ( <a href="#">Section 3.15 on page 72</a> ) Set: BAUD = 9600 PARITY = none STOP = 1 When the remote display is set to gross weight: - if the instrument displays the gross weight, the remote display shows the gross weight. - if the instrument shows the net weight the remote display shows the net weight alternated with the message "net"
bAud	2400 4800 9600 * 19200 38400 115200	Transmission speed.  <b>NOTE: The baud rate must be the same as the baud rate setting in the Serial Communications Settings. See <a href="#">Section 2.5 on page 31</a>.</b>
Raddr	1-99 I *	Instruments address

Table 2-15. SCT-20 TCP/IP Menu Parameters

Parameter	Options	Description
hErEz	iDhz * 20Hz 30Hz 40Hz 50Hz 60Hz 70Hz 80Hz 100Hz 200Hz 300Hz	Maximum Transmission Frequency To be set when the EOnE in transmission protocol is selected. See <a href="#">Figure 2-9 on page 31</a> .  Max setting with min 2400 baud rate  Max setting with min 4800 baud rate  Max setting with min 9600 baud rate Max setting with min 19200 baud rate Max setting with min 38400 baud rate Max setting with min 38400 baud rate
dELAY	0-200 msec 0 *	Delay in milliseconds which elapses before the instrument replies
PARITY	nDnE * EUEn Odd	parity none even parity odd parity
STOP	1* 2	Stop bit
* Indicates default value. ** These settings do not function with Firmware 1.02.00 or lower.		

Table 2-15. SCT-20 TCP/IP Menu Parameters (Continued)

### Front Panel Configuration

1. Press and hold and to enter set-up menu. ERLib will be displayed.
2. Press or until EtknEk is displayed. Press .
3. Press or until desired parameter is displayed. Press .
4. Press or until desired value is displayed. Press .
5. Press twice to exit set-up menu.

## 2.11 Outputs And Inputs Configuration

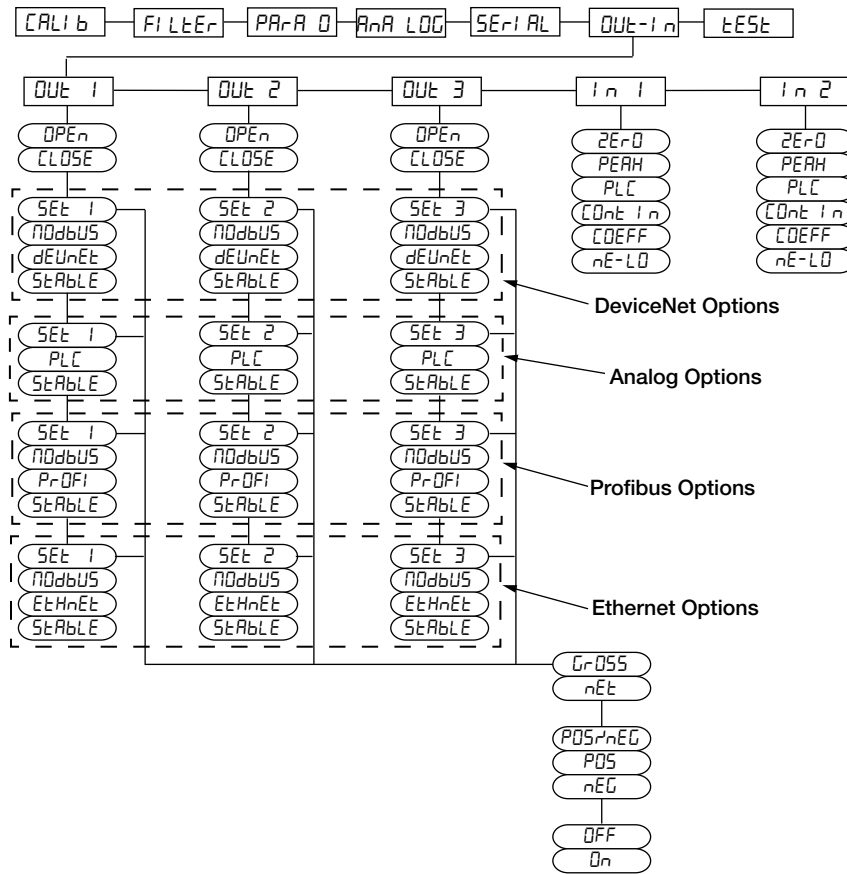

Figure 2-15. Outputs and Inputs Menu Structure













Parameter	Options	Description
Out 1 Out 2 Out 3	OPEn  CLOSE*	<b>Normally Open:</b> the relay is de-energized and the contact is open when the weight is lower than the programmed setpoint value; it closes when the weight is higher than or equal to the programmed setpoint value. <b>Normally closed:</b> the relay is energized and the contact is closed when the weight is lower than the programmed setpoint value; it opens when the weight is higher than or equal to the programmed setpoint value.
Out 1 Out 2 Out 3	SEt 1 SEt 2 SEt 3  NOdbUS dEUnEt PrOFI EtHnEt PLC StAbLE	Number corresponds with OUT 1, 2 or 3 The contact will switch on the basis of weight, according to setpoints. (Section 2.13 on page 41) Select: <b>Gross</b> (default) - the contact will switch on the basis of gross weight or <b>Net</b> - the contact will switch on the basis of net weight (If the net function is not active, the contact will switch on the basis of gross weight). The contact will not switch on the basis of weight, but is controlled by remote Modbus protocol commands. (DeviceNet™, PROFIBUS, Ethernet Only) The contact will not switch on the basis of weight, but is controlled by DeviceNet™. (DeviceNet™ Model Only) The contact will not switch on the basis of weight, but is controlled by PROFIBUS. (PROFIBUS Model Only) The contact will not switch on the basis of weight, but is controlled by Ethernet. (Ethernet Model Only) The contact will not switch on the basis of weight, but is controlled by remote protocol commands. (Analog Only) Relay switching occurs when the weight is stable.
SEt 1 SEt 2 SEt 3	POSnEG* POS NEG	Relay switching occurs for both positive and negative weight values. Relay switching occurs for positive weight values only. Relay switching occurs for negative weight values only.

Table 2-16. Outputs and Inputs Menu Parameters

Parameter	Options	Description	
SEt 1	OFF *	Relay switching will not occur if the setpoint value is '0'.	
SEt 2	On	Setpoint = '0' and nodbus=posneg, relay switching occurs when the weight is '0'; the relay will switch again when the weight is different from zero, taking hysteresis into account (both for positive and for negative weights). Setpoint = '0' and nodes=pos, relay switching occurs for a weight higher than or equal to '0', the relay will switch again for values below '0', taking hysteresis into account. Setpoint = '0' and nodes=neg, relay switching occurs for a weight lower than or equal to '0', the relay will switch again for values above '0', taking hysteresis into account.	
SEt 3			
In 1	nE-L 0*	(NET/GROSS): by closing this input for less than one second, it performs a SEMI-AUTOMATIC TARE and the display will show the net weight. To display the gross weight again, hold the NET/GROSS input closed for three seconds.	
In 2	(In 2 default)		
	ZEr-0*		By closing the input for less than one second, the weight is set to zero ( <a href="#">Section 3.3 on page 44</a> )
	(In 1 default)		
	PEAH		With the input closed the maximum weight value reached remains on display. Opening the input the current weight is displayed.
	PLC		Closing the input no operation is performed, the input status may however be read remotely by way of the communication protocol.
	COntIn	Closing the input for less than one second the weight is transmitted via the serial connection according to the fast continuous transmission protocol one time only (only if contin is set in the item serial).	
	COEFF	When the input is closed the weight is displayed based on the set coefficient, otherwise the weight is displayed. See <a href="#">Section 2.2.7 on page 29</a> .	
* Indicates default value.			

Table 2-16. Outputs and Inputs Menu Parameters (Continued)

## 2.12 Test

1. Press and hold  and .  $CEL_{ib}$  is displayed.
2. Press  or  until  $EESE$  is displayed. Press .
3. Press  or  until desired parameter is displayed. Press .
4. For  $in$  and  $nu-CEL$ , current reading is displayed. Press .
5. For  $Out$ , press  until the corresponding out value change is flashing.
6. Press  to change the value. Press .
7. Press  twice to exit set-up menu.

Parameter	Options	Description
In	N/A	Input Test - for each open input 0 is displayed, 1 is displayed when the input is closed.
Out	0* 1	Output Test - Setting 0 opens the corresponding output . Setting 1 closes the corresponding output .
ANALOG	ANALOG	Allows the analog signal to range between the minimum and the maximum values starting from the minimum.
	NA	Current output test
	UOLt	voltage output test
NU-CEL	N/A	Millivolt Test - displays the load cell response signal in mV with four decimals.
* Indicates default value.		

Table 2-17. Test Parameters



## 2.13 Setpoints Programming

1. Press **←** to enter setpoints and hysteresis settings.
2. Press **◀** or **▲** until desired setpoint or hysteresis parameter is displayed. Press **←**.
3. Press **◀** or **▲** until desired value is displayed. Press **←**.
4. Press **✕** to exit setpoints and hysteresis settings.



**NOTE:** These values are set to zero if the calibration is changed significantly. See [Section 2.2.2.3 on page 26](#) and [Section 2.2.5 on page 27](#).

Parameter	Options	Description
SETP 1 SETP 2 SETP 3	0-Full Scale	Setpoint; relay switching occurs when the weight exceed the value set in this parameter. The type of switching is settable. See <a href="#">Section 2.11 on page 39</a> .
HYSTE 1 HYSTE 2 HYSTE 3	0-Full Scale	Hysteresis, value to be subtracted from the setpoint to obtain contact switching for decreasing weight. For example with a setpoint at 100 and hysteresis at 10, the switching occurs at 90 for decreasing weight.

Table 2-18. Setpoints Parameters

## 2.14 Reserved For The Installer

### 2.14.1 Menu Locking

This procedure, makes it possible to block the access to any menu on the instrument.

1. Press and hold **←** then press **✕**.  $\bar{C}.RL .b$  is displayed.
2. Press **◀** or **▲** until menu to be locked is displayed.
3. Press **✕**, **◀** and **▲** simultaneously for 3 seconds, the display shows  $\bar{C}.RL .b$ . The decimal point between the first and second letter indicates that the menu is now locked. If the operator attempts to enter this menu, access is denied and the display reads  $bL \bar{C}$ .

### 2.14.2 Menu Unlocking

1. Press and hold **←** then press **✕**.  $\bar{C}.RL .b$  is displayed.
2. Press **◀** or **▲** until menu to be unlocked is displayed.
3. Press **←**, **◀** and **▲** simultaneously for 3 seconds, the display shows  $\bar{C}RL .b$ . The decimal point between the first and second letter is gone, indicating the menu is now unlocked.

### 2.14.3 Temporary Menu Unlocking

1. Press and hold **←** then press **✕**.  $\bar{C}.RL .b$  is displayed.
2. Press **◀** or **▲** until menu to be temporarily unlocked is displayed.
3. Press **◀** and **▲** simultaneously for 3 seconds, the display shows  $\bar{C}RL .b$ . The decimal point between the first and second letter is gone, indicating the menu is now unlocked and it is possible to enter and modify all menus. By returning to the weight display, the menu lock is restored.

### 2.14.4 Default Scale



**IMPORTANT:** Operation must only be performed after contacting technical assistance.

1. With power off, press and hold **X**, then power on. Display shows *PRGG*.
2. Press **←**, *bASE* is displayed.
3. Press **◀**, *PASSW* is displayed.
4. Press **←**, *000000* is displayed.
5. Press **◀** and **▲** to enter *6935*.
6. Press **←**, *uA it* is displayed.
7. Instrument will reboot.



**NOTE:** By confirming the displayed program, the system variables are set to default values.

### 2.14.5 Program Selection - Reverse

Scale capacity is displayed when scale is empty. As weight is added display counts down.

1. With power off, press and hold **X**, then power on. *PRGG* is displayed.
2. Press **←**, *bASE* is displayed.
3. Press **◀**, *reverse* is displayed.
4. Press **←**, *uA it* is displayed. Instrument will reboot.

### 2.14.6 Program Selection (Legal for Trade)

The SCT-20 is preset to Legal for Trade NTEP mode with the internal jumper closed.

*nOLEG*: Not Legal for Trade

*LEGAL*: Legal for Trade

*nULt*: Legal for Trade, multi-interval

1. With power off, press and hold **X**, then power on. *PRGG* is displayed.
2. Press **←**, *bASE* is displayed.
3. Press **←**, *nOLEG* is displayed.
4. Press **◀**, *LEGAL* is displayed.
5. Press **←**, *nTEP* (NTEP) is displayed. Press **◀** to switch to *oN it* (OIML).
6. Press **←**, *uA it* is displayed. The instrument will reboot.

Press **X** to quit the program without introducing any changes and without deleting any of the set variables.

### 2.14.7 Program Selection (Non-Legal for Trade)

*nOLEG*: Not Legal for Trade.

*LEGAL*: Legal for Trade

*nULt*: Legal for Trade, multi-interval

1. With power off, press and hold **X**, then power on. *PRGG* is displayed.
2. Press **←**, *bASE* is displayed.
3. Press **←**, *nOLEG* is displayed.
4. Press **←**, *uA it* is displayed. The instrument will reboot.

Press **X** to quit the program without introducing any changes and without deleting any of the set variables.

### 2.14.8 Keypad Or Display Locking

1. Press **X** immediately followed by **▲** and hold both down for about five seconds (this operation is also possible via the MODBUS and ASCII protocols).
2. Press **◀** or **▲** until desired parameter is displayed. Press **↵**.

Parameter	Description
<i>FrEE</i>	No lock
<i>FEY</i>	Keypad lock: If active, when key is pressed the message <i>bLDC</i> is displayed.
<i>d, SP</i>	Keypad and display lock: If active, the keypad is locked and the display shows the instrument model (weight is not displayed); by pressing a key the display shows <i>bLDC</i> for three seconds.

Table 2-19. Keypad or Display Locking Parameters

## 3.0 Operation

### 3.1 Semi-automatic Tare (Net/Gross)



**NOTE:** The semi-automatic tare value is lost upon instrument power-off.

The semi-automatic tare operation is not available if the gross weight is zero.

1. To capture tare and weigh in net mode (Semi-Automatic Tare), close the Net/Gross input or press ◀ for three seconds. The instrument displays the net weight (zero) and the **NET** LED lights up.
2. To display the gross weight again, keep the Net/Gross input closed or press ◀ for three seconds.

This operation may be repeated by the operator to allow the loading of several products.



**NOTE:** Press and hold ▲ to display the gross weight temporarily. When ▲ is released, the net weight will be displayed again.

### 3.2 Preset Tare (Subtractive Tare Device)

It is possible to manually set a preset tare value to be subtracted from the display value provided that the *P-ERR-E* is less than max capacity.

1. Press and hold ← and ◀. *P-ERR-E* is displayed. Press ←.
2. Press ◀ or ▲ until desired value is displayed. Press ←.
3. Press ✕ to exit *P-ERR-E*. After setting the tare value, the weight display shows the net weight (subtracting the preset tare value) and the **NET** LED lights up to show that a tare has been entered.



**NOTE:** Press and hold ▲ for three seconds to display the gross weight temporarily. When ▲ is released, the net weight will be displayed again.

To delete a preset tare and return to the gross weight display:

Press and hold ◀ for three seconds or keep the Net/Gross input closed for three seconds. The preset tare value is set to zero. The **NET** LED is turned off when the gross weight is displayed once again.



**NOTE:** If a semi-automatic tare is entered, it is not possible to access the preset tare function.

If a preset tare is entered, it is still possible to access the semiautomatic tare function. The two different types of tare are added.

All the semi-automatic tare and preset tare values will be lost when the instrument is turned off.

### 3.3 Semi-automatic Zero (Weight Zero-setting For Small Variations)

By closing the **Semi-Automatic Zero** input, the weight is set to zero. The zero setting will be lost when the instrument is turned off.

This function can only be used if the weight is lower than the 0 set value, otherwise the *t----* alarm appears and the weight is not set to zero. See [Section 2.4 on page 30](#).

### 3.4 Peak

By keeping the input closed, the maximum weight value reached remains displayed. Upon opening the input, the current weight is displayed.



**NOTE:** To view a sudden variation peak, set the **FILTER ON THE WEIGHT** to 0.

### 3.5 Info Menu

Select this menu to display the main legally relevant parameters.

1. Press and hold **←** and **✕** to enter setup menu. *CAL* displays.
2. Press **◀** or **▶** until *ES* displays. Press **←**. The following information will display in sequence.
  - *PrOG*: Operation mode
  - *rEFnD*: Number of qualified access
  - *FS-EEQ*: Full scale
  - *SENs*: Load cell sensitivity
  - *E (E1, E2, ?E3)*: Verification scale interval
  - *nAh (nAh1, ?nAh2, ?nAh3)*: Maximum capacity
  - *G CAL*: Gravity acceleration in the calibration area
  - *G USE*: Gravity acceleration in the work area
  - *rELDAd*: Restoring memory storage and printing functions
  - *unit C*: Units of measure whit active coefficient
  - *COEFF*: Display coefficient
  - *FiltEr*: Filter on the weight

### 3.6 Alarms

Display	Description
<i>ErCEL</i>	The load cell is not connected or is incorrectly connected; the load cell signal exceeds 39 mV; the conversion electronics. The A/D converter is malfunctioning. The load cell is a 4-wire and there are no jumpers between EX- and REF- and between EX+ and REF+.
<i>Er OL</i>	The weight display exceeds 110% of the full scale.
<i>Er Ad</i>	Internal instrument converter failure. Check load cell connections and, if necessary, contact Rice Lake Weighing Systems Technical Support.
-----	The weight exceeds the maximum weight by 9 divisions.
<i>Er OF</i>	The maximum displayable value was exceeded (value higher than 999999 or lower than -999999).
<i>E-----</i>	The weight is too high: zero setting is not possible.
<i>nAh-Pu</i>	This message appears in the test weight setting, in Weight (Span) Calibration, after the fifth test weight value has been entered.
<i>ErrOr</i>	The value set for the parameter is beyond the permitted values; press <b>✕</b> to quit the setting mode leaving the previous value unchanged. Example: a number of decimals is selected for full scale which exceeds the instrument's display potential; value above the maximum setting value; the weight value set in test weight verification does not match the detected mV increase.
<i>bLDC</i>	Lock is active on menu item, keypad or display.
<i>nDdL SP</i>	It is not possible to display the number properly because it is greater than 999999 or less than -999999.

Table 3-1. Alarms

**DeviceNet™ Error (DeviceNet Models Only):** A problem in the DeviceNet communication is marked by a lack of flashing or a slow flashing (duration about 0.5 s) of the DeviceNet status LED.

**PROFIBUS Error (PROFIBUS Models Only):** A problem in the PROFIBUS communication is marked by a lack of flashing or a slow flashing (duration about 0.5 s) of the PROFIBUS status LED.

**EtherNet/IP™ Error (Ethernet Models Only):** A problem in the Ethernet communication is marked by a slow flashing (duration about 0.5 s) of the Ethernet status LED.

**Modbus-TCP Error (Modbus-TCP Models Only):** A problem in the Modbus-TCP communication is marked by a slow flashing (duration about 0.5 s) of the Modbus-TCP status LED.

MODE	<i>ErCEL</i>	<i>Er OL</i>	<i>Er Ad</i>	-----	<i>Er OF</i>	<i>t-----</i>
Bit LSB	76543210 xxxxxx1	76543210 xxxx1xxx	76543210 xxxxxx1x	76543210 xxxxx1xx	76543210 On gross: xxx1xxxx On net: xx1xxxxx	The response to the zero command is a <b>value not valid</b> error (error code 3)
Status Register MODBUS RTU						
ASCII	__O-F_	__O-L_	__O-F_	__O-L_	__O-F_	&aa#CR
RIP *	__O-F_	__O-L_	__O-F_	__O-L_	__O-F_	__O-F_
HDRIP-N	_ERCEL	_ER_OL	_ER_AD	#####	_ER_OF	O_SET
CONTIN	_ERCEL	_ER_OL	_ER_AD	^^^^^^	_ER_OF	O_SET

Table 3-2. Serial Protocol Alarms

\* For RIP remote displays, if the message exceeds 5 digits the display reads -----.



**NOTE:** In case of alarm, the relays not managed by Modbus, Modbus-TCP or DeviceNet will open.

In **Analog Models**, if an alarm becomes active the relays open and the analog outputs go to the lowest possible value according to the following table:

Range	0/20mA	4/20 mA	0/5 V	0/10 V	-10/10 V	-5/5 V
Output Value	-0.2 mA	3.5 mA	-0.5 V	-0.5 V	0 V	0 V

Table 3-3. Analog Outputs with Active Alarms

### 3.7 DeviceNet

The SCT20-DN works as a source in a DeviceNet network.

Load the included EDS file (DeviceNet\_20.eds) in the DeviceNet primary's development instrument.

The data exchanged by SCT20-DN are:

Outgoing Data from SCT-20 DeviceNet (Read)	Addresses
Gross Weight [4 bytes]	0x0000-0x0003
Net Weight [4bytes]	0x0004-0x0007
Setpoint [4 bytes]	0x0008-0x000B
Status Register [2 bytes]	0x000C-0x000D
Digital Inputs Status [1 byte]	0x000E
Digital Outputs Status [1 byte]	0x000F

Input Data to SCT-20 DeviceNet (Write)	Addresses
Command Register [2 bytes]	0x0000-0x0001
Digital Outputs Command [2 bytes]	0x0002-0x0003
Setpoint [4 bytes]	0x0004-0x0007

Table 3-4. Exchanged Data SCT-20 DeviceNet

## Possible Command To Send To The Command Register

Code	Description	Code	Description
0	No command	90	Read setpoint 1
7	Semi-automatic tare (NET display)	91	Read setpoint 2
8	SEMI-AUTOMATIC ZERO	92	Read setpoint 3
9	GROSS display	93	Write setpoint 1
21	Keypad lock	94	Write setpoint 2
22	Keypad and display unlock	95	Write setpoint 3
23	Keypad and display lock	99	Save data in EEPROM
		9999	Reset (reserved)

Table 3-5. Commands to Command Register (DeviceNet)



**NOTE:** To execute the same command twice consecutively, send command 0 between the first command and the following one.

### Gross Weight, Net Weight:

The weight values are expressed as positive integer numbers, including decimal figures but without decimal point.

Read the Status Register to obtain information about sign and possible errors on the weight.

### Setpoints:

The Setpoints are weight values expressed as positive integer numbers, including decimal figures but without decimal point.

- **READING** – send to the Command Register the reading command of the required setpoint (e.g. 90 for reading setpoint 1) and read the content of the Setpoint register.
- **WRITING** – write the weight value to be set in the Setpoint and send to the Command Register, the writing command of the required setpoint (e.g. 93 for writing setpoint 1).



**NOTE:** Setpoints are stored to the RAM volatile memory and lost upon instrument power off. To save them permanently in the EEPROM memory, so that they are maintained upon the instrument power on, it is necessary to send the command 99 (Save data in EEPROM) of the Command Register.

### Digital Inputs Status

Bit No.	Description	Bit No.	Description
Bit 0	INPUT 1 status	Bit 4	—
Bit 1	INPUT 2 status	Bit 5	—
Bit 2	—	Bit 6	—
Bit 3	—	Bit 7	—

Table 3-6. Digital Inputs (DeviceNet)

Bit 1: input high; Bit 0: input is low

### Digital Outputs Status

Bit No.	Description	Bit No.	Description
Bit 0	OUTPUT 1 status	Bit 4	—
Bit 1	OUTPUT 2 status	Bit 5	—
Bit 2	OUTPUT 3 status	Bit 6	—
Bit 3	—	Bit 7	—

Table 3-7. Digital Outputs (DeviceNet)

## Digital Outputs Command

It allows to control the outputs status in *dEUnEt* mode. See [Section 2.11 on page 39](#).

Bit No.	Description	Bit No.	Description
Bit 0	OUTPUT 1 status	Bit 8	—
Bit 1	OUTPUT 2 status	Bit 9	—
Bit 2	OUTPUT 3 status	Bit 10	—
Bit 3	—	Bit 11	—
Bit 4	—	Bit 12	—
Bit 5	—	Bit 13	—
Bit 6	—	Bit 14	—
Bit 7	—	Bit 15	Force Output

Table 3-8. Digital Outputs Command (DeviceNet)

Bit 1: output is closed; Bit 0: output is open.



**NOTE:** Setting bit 15 to 1 on the PLC, DeviceNet takes control of all the outputs, even if they are in different modes.

## Status Register

Bit No.	Description	Bit No.	Description
Bit 0	Cell Error	Bit 8	Net weight negative sign
Bit 1	A/D Converter Malfunction	Bit 9	Peak weight negative sign
Bit 2	Maximum weight exceeded by 9 divisions	Bit 10	Net display mode
Bit 3	Gross weight higher than 110% of full scale	Bit 11	Weight stability
Bit 4	Gross weight beyond 999999 or less than -999999	Bit 12	Weight within +/- 1/4 of a division around ZERO
Bit 5	Net weight beyond 999999 or less than -999999	Bit 13	—
Bit 6	—	Bit 14	—
Bit 7	Gross weight negative sign	Bit 15	Force Output

Table 3-9. Status Register (DeviceNet)

## 3.8 PROFIBUS

- The SCT20-PB works as a PROFIBUS DP V0 source in a PROFIBUS-DP network.
- Load the included .gsd file (Profibus\_20.gsd) attached to the instrument in the development system of the PROFIBUS primary.
- The available modules are:
  - **R** = the register can be read only
  - **W** = the register can be written only
  - **R/W** = the register can be both read and written

MODULE	Saving to EEPROM	N. Byte R	N. Byte W	ACCESS
GROSS WEIGHT)		4		R
NET WEIGHT		4		R
PEAK WEIGHT		4		R
SETPOINT 1	Only after command 99 of the COMMAND REGISTER	4	4	R/W
SETPOINT 2		4	4	R/W
SETPOINT 3		4	4	R/W
HYSTERESIS 1		4	4	R/W
HYSTERESIS 2		4	4	R/W
HYSTERESIS 3		4	4	R/W

Table 3-10. PROFIBUS Modules



MODULE	Saving to EEPROM	N. Byte R	N. Byte W	ACCESS
Divisions and Units of measure		2		R
Visualization Coefficient		4		R
INPUTS		2		R
OUTPUTS	NO	2	2	R/W
STATUS REGISTER		2		R
COMMAND REGISTER	NO		2	W
Sample Weight for calibration	Use with command 101 of the COMMAND REGISTER	4	4	R/W

Table 3-10. PROFIBUS Modules (Continued)

### GROSS WEIGHT – NET WEIGHT – PEAK

The weight values are expressed as positive integer numbers, include decimal figures but without decimal point.

Read the Status Register to obtain information about sign and possible errors on the weight.

To find out the decimal figures use the division module value; *Example: the net weight is 100000 and the division is 0.001 (three decimals), the real weight value is 100.000kg.*

### Setpoints – Hysteresis

The weight values are expressed as positive integer numbers, include decimal figures but without decimal point.

- To set the value to 0; write the hexadecimal value hex 80000000 to the register (the most significant bit is 1 and all the other bits are 0).
- To set them correctly consider the module Division value; E.g. to set a set-point to 100kg and the verification division value is 0.001, set the set-point value to 100000 (remove the decimal points from the value that would be 100.000 with decimals).
- If from PLC, a values is set out of the permitted interval (from 0 (not included) to full scale) the value is ignored and the bit 13 (Writing error) rises in the Status Register.



**NOTE: Setpoints and Hysteresis are stored to the RAM volatile memory and lost upon instrument power off. To save them permanently in the EEPROM memory, so that they are maintained upon the instrument power on, it is necessary to send the command 99 (Save data in EEPROM) of the Command Register.**

### Divisions And Units Measure Registry (40014)

This register contains the current setting of the divisions (parameter *division*) and of the units of measure (parameter *unit*). Use this register together with the coefficient registers to calculate the value displayed by the instrument.

Least significant byte L Byte (Division)			Most significant byte H Byte (Units of Measure)		
Division value	Divisor	Decimals	Units of measure value	Units of measure description	Utilization of the Coefficient value with the different units of measure settings compared to the gross weight detected
0	100	0	0	Kilograms	Does not intervene
1	50	0	1	Grams	Does not intervene
2	20	0	2	Tons	Does not intervene
3	10	0	3	Pounds	Does not intervene
4	5	0	4	Newton	Multiples
5	2	0	5	Liters	Divides
6	1	0	6	Bar	Multiples
7	0.5	1	7	Atmospheres	Multiples
8	0.2	1	8	Pieces	Divides
9	0.1	1	9	Newton Meter	Multiples

Table 3-11. Division and Units Measure Registry

Least significant byte L Byte (Division)		
10	0.05	2
11	0.02	2
12	0.01	2
13	0.005	3
14	0.002	3
15	0.001	3
16	0.0005	4
17	0.0002	4
18	0.0001	4

Most significant byte H Byte (Units of Measure)		
10	Kilogram Meter	Multiples
11	Other	Multiples

Table 3-11. Division and Units Measure Registry (Continued)

### Coefficient Display

The PROFIBUS register contains the value of parameter **CDEFF**, expressed as integer number, with 4 decimal figures but without decimal point.

E.g.: If **CDEFF** is 1.2000, the PROFIBUS register contains 12000.

### Digital Inputs Status

Bit No.	Description	Bit No.	Description
Bit 0	INPUT 1 status	Bit 8	—
Bit 1	INPUT 2 status	Bit 9	—
Bit 2	—	Bit 10	—
Bit 3	—	Bit 11	—
Bit 4	—	Bit 12	—
Bit 5	—	Bit 13	—
Bit 6	—	Bit 14	—
Bit 7	—	Bit 15	—

Table 3-12. Digital Input Status (PROFIBUS)

Bit 1: input high; Bit 0: input is low

### Digital Outputs Command

It allows control to the outputs status in **PROFIBUS**. See [Section 2.11 on page 39](#).

Bit No.	Description	Bit No.	Description
Bit 0	OUTPUT 1 status	Bit 8	—
Bit 1	OUTPUT 2 status	Bit 9	—
Bit 2	OUTPUT 3 status	Bit 10	—
Bit 3	—	Bit 11	—
Bit 4	—	Bit 12	—
Bit 5	—	Bit 13	—
Bit 6	—	Bit 14	—
Bit 7	—	Bit 15	Force Output

Table 3-13. Digital Outputs Command (PROFIBUS)

Bit 1: output is closed; Bit 0: output is open.



**NOTE:** Setting bit 15 to 1 on the PLC, PROFIBUS takes control of all the outputs, even if they are in different modes.

## Status Register

Bit No.	Description
Bit 0	Cell Error
Bit 1	A/D Converter Malfunction
Bit 2	Maximum weight exceeded by 9 divisions
Bit 3	Gross weight higher than 110% of full scale
Bit 4	Gross weight beyond 999999 or less than -999999
Bit 5	Net weight beyond 999999 or less than -999999
Bit 6	—
Bit 7	Gross weight negative sign
Bit 8	Net weight negative sign
Bit 9	Peak weight negative sign
Bit 10	Net display mode
Bit 11	Weight stability
Bit 12	Weight within $\pm 1/4$ of a division around ZERO
Bit 13	Writing error
Bit 14	—
Bit 15	—

Table 3-14. Status Register (PROFIBUS)

Bit 13 (writing error) rises if the PLC tries to write a value out of a parameter's permitted interval. In this case the writing has no effect and the previous parameter value is maintained.

## Possible Command To Send To The Command Register

Code	Description	Code	Description
0	No command	17	Reserved
7	NET display	18	Reserved
8	SEMI-AUTOMATIC ZERO	21	Keypad lock
10	Reserved	22	Keypad and display unlock
11	Reserved	23	Keypad and display lock
12	Reserved	99	Save data in EEPROM
13	Reserved	100	Zero-setting for calibration
14	Reserved	101	Sample weight storage for calibration
15	Reserved	9999	Reset (reserved)
16	Reserved		

Table 3-15. Commands to Command Register (PROFIBUS)



**NOTE:** To execute the same command twice consecutively, send command 0 between the first command and the following one.

### 3.8.1 Real Calibration Commands (With Sample Weight)

The SCT20-PB calibration can be changed via PROFIBUS.

To correctly set the sample weight, the value of the division module must be taken into consideration.

*Example: to set the value to 100kg and the division value is 0.001, set the register value to 100000 (remove the decimal points from the value that would be 100.000 with decimals).*

To perform the edit calibration procedure:

1. Using the command 100 **Zero-Setting for calibration** of the command register, unload the system and ensure the display reads zero.
2. Place a sample weight on the scale.
3. Record the correct known weight value in the **Sample Weight for Calibration** register.
4. Send the command 101 **Sample weight storage for calibration**.
5. To verify the correct execution of the calibration command:
  - Write the sample weight value to the **Sample Weight for Calibration** module.
  - Write the value 0 to the **Sample Weight for calibration** module.
  - Send the command 101 **Sample weight storage for calibration** to the Command Register
  - The operation works correctly if the module value **Sample Weight for calibration** goes to zero.

See [Table 3-15 on page 51](#) for a list of PROFIBUS commands.



**NOTE:** Changing some instrument parameters via keyboard can take the PROFIBUS network out of the data exchange status and put the PLC in stop status; when programming the instrument the plant must be in stand-by status.

## 3.9 EtherNet/IP™

The SCT20-IP works as a device in a EtherNet/IP network.

### 3.9.1 Instrument Setup

1. Press and hold **←** and **✕**. **CAL ib** displays.
2. Press **◀** or **▲** until **EtHnEt** displays. Press **←**.
3. Press **◀** or **▲** to navigate through menu.
  - **SwAP**: select the reading/writing of the byte in LITTLE-ENDIAN or BIG-ENDIAN mode
    - **YES**: BIG ENDIAN
    - **nO**: LITTLE ENDIAN (default)
  - **iPAddr**: set instrument IP address (default: 192.8.0.141)
  - **SubnEt**: set instrument Subnet Mask (default: 255.255.255.0)
  - **GAteWAY**: set Gateway address of Ethernet network (default: 192.8.0.111)
4. Press **✕** until **EtHnEt** displays to apply changes.

Load the included EDS file (Ethernet\_20.eds) in the EtherNet/IP scanner's development instrument; or, open Class 1 I/O Connection with the following settings:

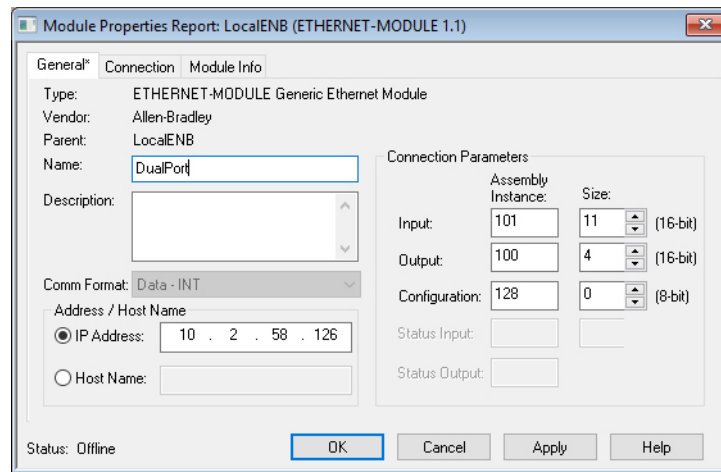

Figure 3-1. Dual Port – Generic EtherNet/IP Module Setup

- If explicit messages are used and the PLC supports class 3 connections (with appropriate interface), insert the data shown in [Figure 3-1](#).
- If explicit messages are used and the PLC needs data read/write messages to be constructed manually use the settings in [Table 3-16](#).

Field	Read	Write
Service	0x0E	0x10
Class	0x04	0x04
Instance	0x65	0x64
Attribute	0x03	0x03
Data	NO	Byte array to be written

Table 3-16. Manual Settings for Communication

### 3.9.2 Dual Port EtherNet/IP Interface

Dual port interface uses a different configuration file compared to the single port, making the connection parameters different between the two outputs.

#### EDS File Setup

The configuration used when setting up a device with the EDS file.

Output Data from SCT-20 EtherNet/IP (Read)	Addresses	Type
Gross Weight [4 byte]	0x0000-0x0003	Double Integer
Net Weight [4 byte]	0x0004-0x0007	Double Integer
Exchange Register [4 byte]	0x0008-0x000B	Double Integer
Status Register [2 byte]	0x000C-0x000D	Integer
Digital Inputs status [2 byte]	0x000E-0x000F	Integer
Digital Outputs status [2 byte]	0x0010-0x0011	Integer

Table 3-17. EDS Output Data – Dual Port Interface (EtherNet/IP)

Input Data to SCT-20 EtherNet/IP (Write)	Addresses	Type
Command Register [2 byte]	0x0000-0x0001	Integer
Digital Outputs Command [2 byte]	0x0002-0x0003	Integer
Exchange Register [4 byte]	0x0004-0x0007	Double Integer

Table 3-18. Input Data to SCT-20 (EtherNet/IP)

## Generic EtherNet/IP Module Setup

The configuration used when setting up a device with the generic module file.

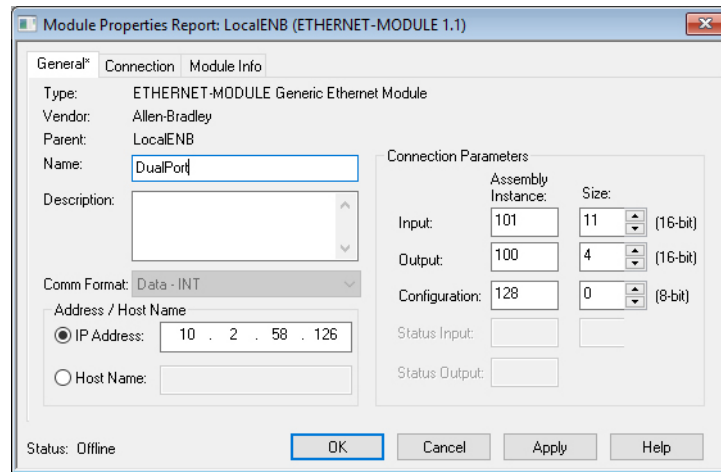

Figure 3-2. Dual Port – Generic EtherNet/IP Module Setup

Output Data from SCT-20 EtherNet/IP (Read)	Addresses	Type
Header Information [4 bytes]	0x0000-0x0003	Double Integer
Gross Weight [4 byte]	0x0004-0x0007	Double Integer
Net Weight [4 byte]	0x0008-0x000B	Double Integer
Exchange Register [4 byte]	0x000C-0x000F	Double Integer
Status Register [2 byte]	0x0010-0x0011	Integer
Digital Inputs status [2 byte]	0x0012-0x0013	Integer
Digital Outputs status [2 byte]	0x0014-0x0015	Integer

Table 3-19. Generic Module Output Data – Dual Port Interface (EtherNet/IP)

Input Data to SCT-20 EtherNet/IP (Write)	Addresses	Type
Command Register [2 byte]	0x0000-0x0001	Integer
Digital Outputs Command [2 byte]	0x0002-0x0003	Integer
Exchange Register [4 byte]	0x0004-0x0007	Double Integer

Table 3-20. Input Data to SCT-20 (EtherNet/IP)

## Possible Command To Send To The Command Register

Code	Description	Code	Description
0	No command	7	Semi-Automatic Tare enabling (net weight displaying)
8	Semi-Automatic Zero	9	Semi-Automatic Tare disabling (gross weight displaying)
20		21	Keypad lock
22	Keypad and display unlock	23	Keypad and display lock
86		87	Preset Tare reading*
88	Preset Tare writing*	89	
90	Setpoint 1 reading*	91	Setpoint 2 reading*
92	Setpoint 3 reading*	93	Setpoint 1 writing*
94	Setpoint 2 writing*	95	Setpoint 3 writing*
98		99	Save data in EEPROM
100	Tare Weight Zero Setting for calibration	101	Sample weight storage for calibration
102	Sample Weight reading*	103	Sample Weight writing*
130	Preset Tare enabling	131	

Table 3-21. Commands to Command Register (EtherNet/IP)



**NOTE:** To execute the same command twice consecutively, send command 0 between the first command and the following one.

### Internal Status

When the internal status is not 0 there is an internal error, so data from SCT-20 EtherNet/IP are not reliable.

When the internal status is 0 data from SCT-20 EtherNet/IP are reliable.

### Header Information

The header information value must be a 1, if it is a 0 then the SCT-20 needs to be replaced.

### Write Enable

Write 0x0000 in the **Write Enable** register to ensure that no data are written to SCT-20 EtherNet/IP.

Write 0xFFFF in the **Write Enable** register to enable that data are written to SCT-20 EtherNet/IP.

### Gross weight, Net weight:

The weight values are expressed as positive integer numbers; they include decimal figures without a decimal point.

Read the **Status Register** to obtain informations about sign and possible errors on the weight.

### Setpoints:

The setpoints are weight values expressed as positive integer numbers; they include decimal figures without a decimal point.

- Reading: send to the Command Register the reading command of the required setpoint and read the content of the Setpoint Register. *Example: 90 for reading setpoint 1.*
- Writing: write the weight value to be set in the setpoint and send to the Command Register the writing command of the required setpoint. *Example: 93 for writing setpoint 1.*



**NOTE:** Setpoints are stored to the RAM volatile memory; they are lost upon instrument power off. To save them permanently in the EEPROM memory, so that they are maintained upon the instrument power on. It is necessary to send the command 99 Save data in EEPROM to the command register.

### Digital Inputs Status

Bit No.	Description	Bit No.	Description
Bit 0	INPUT 1 status	Bit 4	—
Bit 1	INPUT 2 status	Bit 5	—
Bit 2	—	Bit 6	—
Bit 3	—	Bit 7	—

Table 3-22. Digital Input Status (EtherNet/IP)

Bit 1: input high; Bit 0: input is low

## Digital Outputs Status

Bit No.	Description	Bit No.	Description
Bit 0	OUTPUT 1 status	Bit 4	—
Bit 1	OUTPUT 2 status	Bit 5	—
Bit 2	OUTPUT 3 status	Bit 6	—
Bit 3	—	Bit 7	—

Table 3-23. Digital Output Status (EtherNet/IP)

## Digital Outputs Command

It allows control to the outputs status in *ETHERNET* mode. See [Section 2.11 on page 39](#).

Bit No.	Description	Bit No.	Description
Bit 0	OUTPUT 1 status	Bit 8	—
Bit 1	OUTPUT 2 status	Bit 9	—
Bit 2	OUTPUT 3 status	Bit 10	—
Bit 3	—	Bit 11	—
Bit 4	—	Bit 12	—
Bit 5	—	Bit 13	—
Bit 6	—	Bit 14	—
Bit 7	—	Bit 15	Force Outputs

Table 3-24. Digital Outputs Command (EtherNet/IP)

Bit 1: output is closed; Bit 0: output is open.



**NOTE:** Setting bit 15 to 1 on the PLC DeviceNet takes control of all the outputs, even if they are in different modes.

## Status Register

Bit No.	Description
Bit 0	Cell Error
Bit 1	A/D Converter Malfunction
Bit 2	Maximum weight exceeded by 9 divisions
Bit 3	Gross weight higher than 110% of full scale
Bit 4	Gross weight beyond 999999 or less than -999999
Bit 5	Net weight beyond 999999 or less than -999999
Bit 6	
Bit 7	Gross weight negative sign
Bit 8	Net weight negative sign
Bit 9	Peak weight negative sign
Bit 10	Net display mode
Bit 11	Weight stability
Bit 12	Weight within $\pm\frac{1}{4}$ of a division around ZERO
Bit 13	
Bit 14	
Bit 15	

Table 3-25. Status Register (EtherNet/IP)



### 3.10 Ethernet TCP/IP

To configure Ethernet TCP/IP port of SCT-20 TCP/IP, the Lantronix DeviceInstaller must be installed on a Windows PC.

1. Connect the PC and SCT-20 TCP/IP through a LAN, point-to-point or with hub/switch.
2. Run the Lantronix Device Installer file (DevInst.exe) on the CD or download and run installer from <https://www.lantronix.com/>.
3. Select **Search** and the application will find the SCT-20 TCP/IP in the LAN.

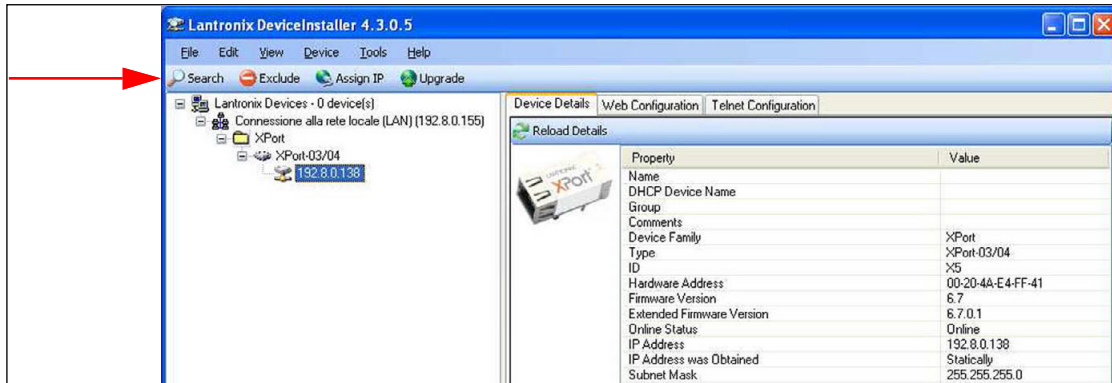

Figure 3-3. Find SCT-20 TCP/IP in LAN

4. Select the device and then select the **Telnet Configuration**.
5. Select the Connect button and then press **Enter**.

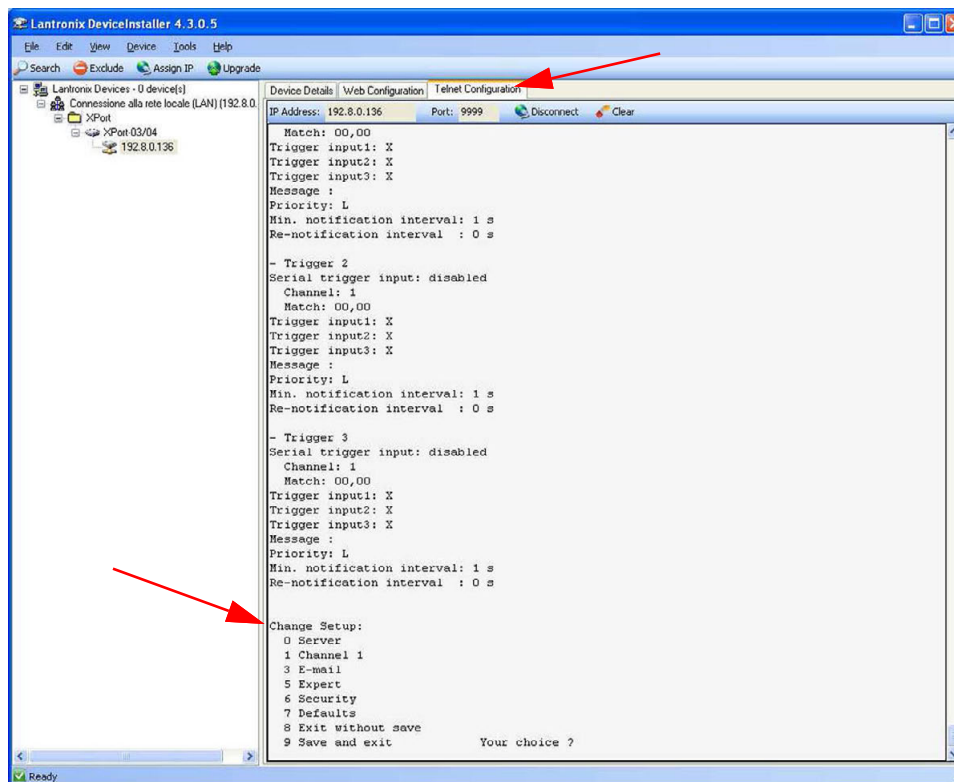

Figure 3-4. Telnet Configuration

6. Press **0 Server** and change only the IP Address fields. It is strongly recommended to set a fixed IP Address. Do not change any other parameters. Press **Enter** to confirm.
7. Press **1 Channel** to change the serial baud rate of the Ethernet Module to match the baud rate set in SCT-20 TCP/IP Protocol Selection (default 9600). Do not change any other parameters. Press **Enter** to confirm.

To connect to the SCT-20 TCP/IP using a socket (for example Winsock), the port to use is 10001.

To connect to SCT-20 TCP/IP via Ethernet TCP/IP through a serial virtual port (virtual COM port of a PC) perform the following steps.

1. Run TCPIP.exe found on the CD.
2. Enter the IP Address of SCT-20 TCP/IP and press **ACTIVATE**. This activates the socket connection.
3. Type the ASCII command (without CR) and press **SEND**. The answer displays in the Received box.

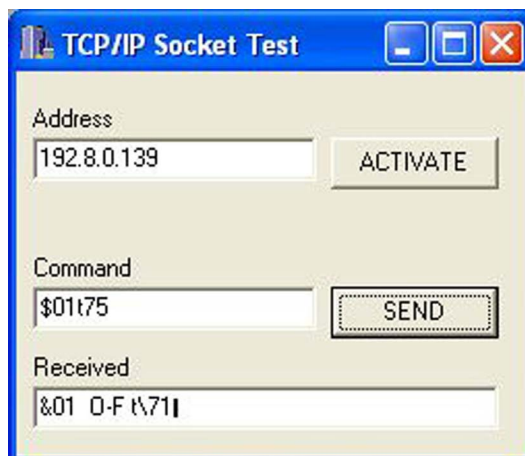

Figure 3-5. TCP/IP Socket Test Screen

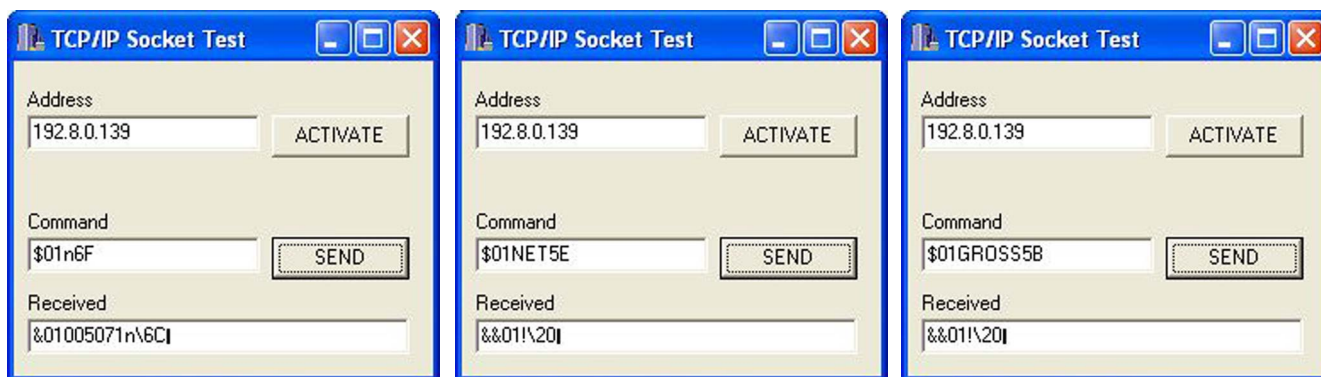

Figure 3-6. TCP/IP Socket Test Screen (Examples)

Use the added COM to communicate with SCT-20 TCP/IP using the selected protocol.



**NOTE:** SCT-20 TCP/IP.exe is included on the CD for testing commands and it only works with Port 10001.

Do not include the <CR> with the command.

Supports the same commands as ASCII. See [Section 3.13 on page 67](#).

### Protocol Selection

To select the protocol to use on the Ethernet port, choose one of the following:

- *Ethnet* - Mode lines of the list below (none, Modbus, ASCII, Contin, Rip, Hdrip, Hdripn). See [Section 2.10 on page 37](#).
- *iPAddr*, *Subnet*, *GATEWAY* are not yet used, IP Address, Subnet Mask or Gateway address cannot be assigned directly through the keyboard: use configuration SW Lantronix DeviceInstaller.
- *uEb5rU* protocol is not yet implemented.

### 3.11 Modbus-TCP

The SCT-20 Modbus-TCP works as a source in a Modbus-TCP network. The instrument features a Modbus-TCP port that allows the exchange of weight and the main parameters with a Modbus-TCP leader. The RJ-45 port provides 10Base-T or 100Base-TX (auto-detect) and the following indicators:

RJ-45 Indicator	Description
Left LED Indicators	Off - No Link Amber - 10 Mb/s Green - 100 Mb/s
Right LED Indicators	Off - No activity Amber - Half duplex Green - Full duplex

Table 3-26. SCT-20MB LED Indicators



**NOTE:** The instrument operates as follower in a Modbus-TCP network. Use port 502 for the communication.

#### 3.11.1 SCT-20/SCT-40 Modbus-TCP Setup

In order to set up the SCT-20/SCT-40 Modbus TC/IP utility, use TELNET since no setup is available from the display.

The default IP address is: 192.8.0.158.



**NOTE:** The TELNET settings for serial are set to: 9600,8,N,1.  
Ensure the gateway IP address is not set when no gateway is used.

#### 3.11.2 Set IP Address with Lantronix Software

To configure the IP address of SCT-20 Ethernet TCP/IP or Modbus, the Lantronix DeviceInstaller must be installed on to a Windows PC.

1. Connect the PC and SCT-20 TCP/IP through a LAN, point-to-point or with hub/switch.
2. Run the Lantronix DeviceInstaller file (DevInst.exe) on the CD or download and run installer from <https://www.lantronix.com/>.
3. Select **Search**. The application will find the SCT-20 TCP/IP connected to the LAN.
4. Click **Assign IP**.

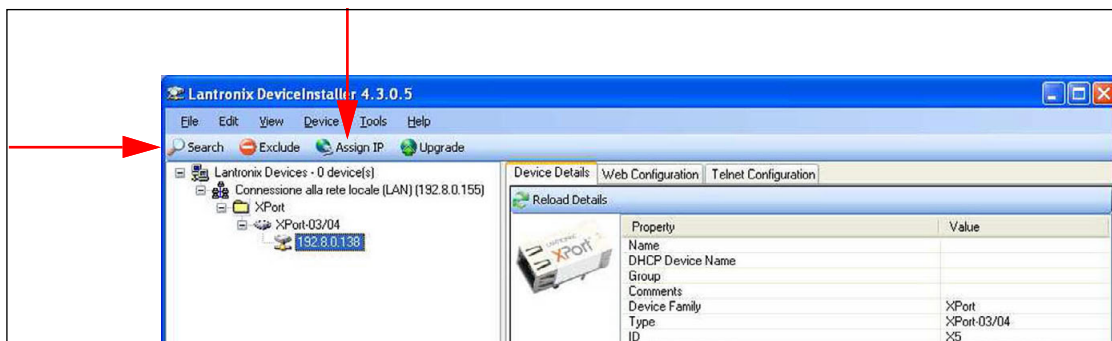

Figure 3-7. Lantronix DeviceInstaller

5. Select **Assign a specific IP address** then **Next**.

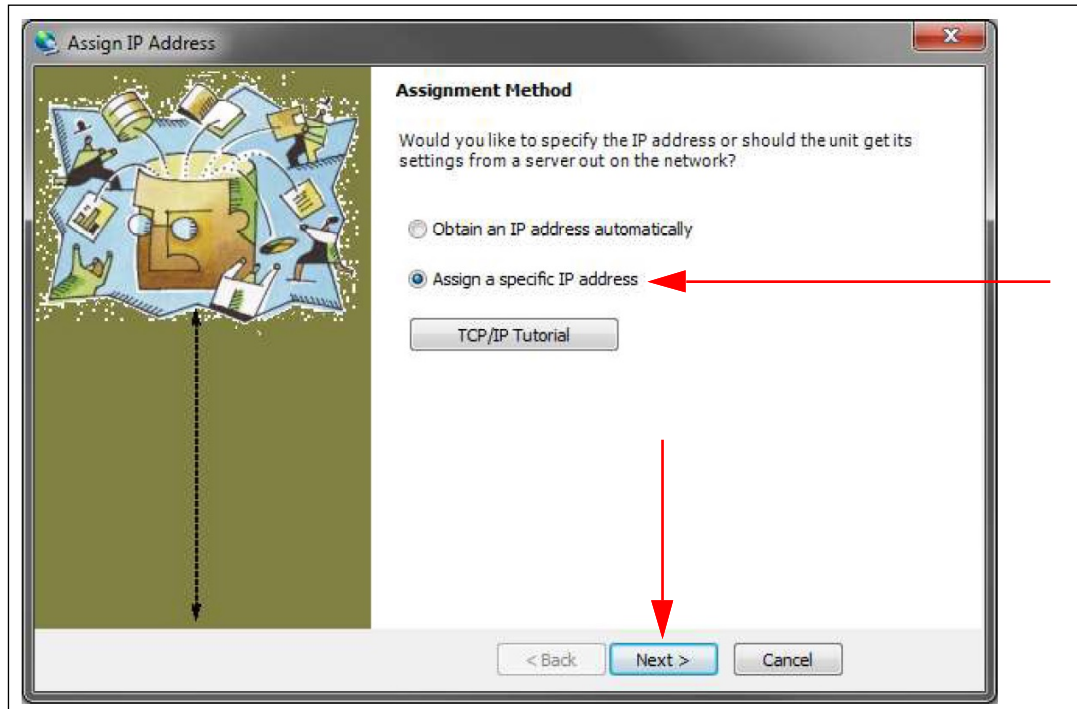

Figure 3-8. Assign IP Address Window

6. Follow on screen prompts to enter the desired values then click **Assign**.
7. Wait for the process to complete (no need to restart the SCT-20).



**NOTE:** Modbus-TCP commands and registers are the same as Modbus-RTU protocol. For more information, see [Section 3.12 on page 61](#).

### 3.11.3 Set IP Address Via Telnet

The instrument is configured with dynamic host configuration protocol (DHCP) as the default. The IP address can be automatically assigned by DHCP, or manually via Telnet.

To set the IP address via Telnet:

1. Type `telnet <ipaddress> 9999` and press **Enter** to confirm. The following displays:

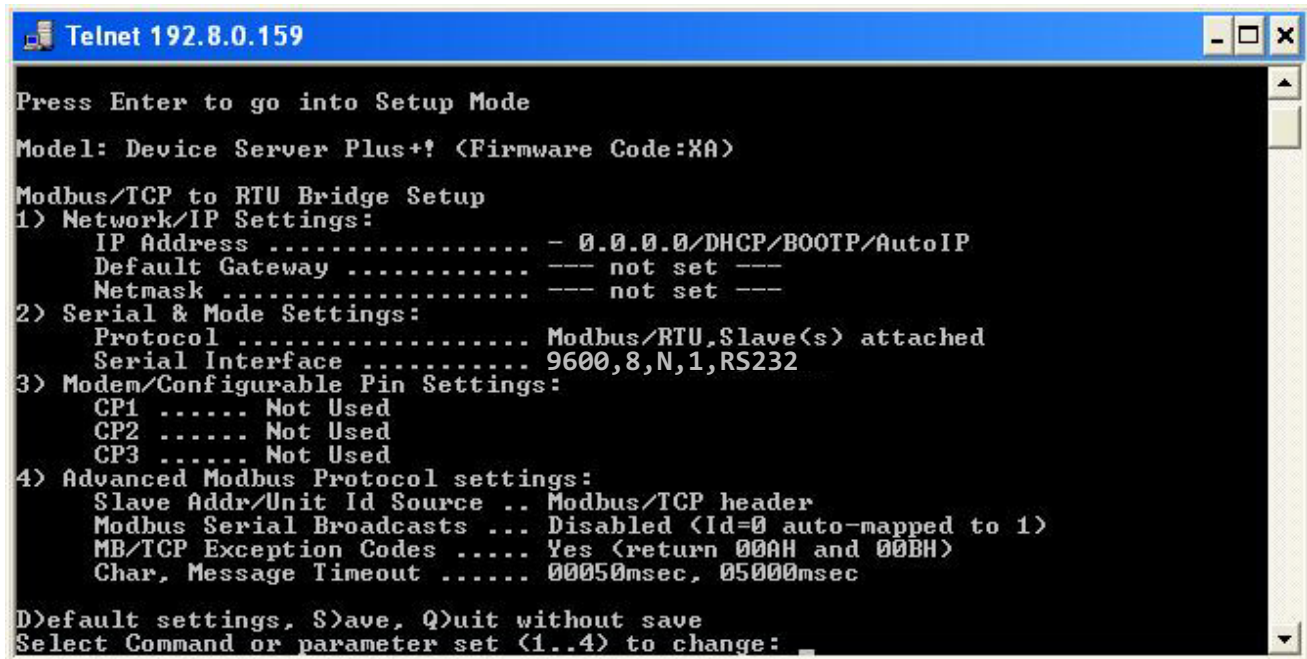

```

Telnet 192.8.0.159
Press Enter to go into Setup Mode
Model: Device Server Plus+! (Firmware Code:XA)
Modbus/TCP to RTU Bridge Setup
1) Network/IP Settings:
   IP Address ..... - 0.0.0.0/DHCP/BOOTP/AutoIP
   Default Gateway ..... --- not set ---
   Netmask ..... --- not set ---
2) Serial & Mode Settings:
   Protocol ..... Modbus/RTU,Slave(s) attached
   Serial Interface ..... 9600,8,N,1,RS232
3) Modem/Configurable Pin Settings:
   CP1 ..... Not Used
   CP2 ..... Not Used
   CP3 ..... Not Used
4) Advanced Modbus Protocol settings:
   Slave Addr/Unit Id Source .. Modbus/TCP header
   Modbus Serial Broadcasts ... Disabled (Id=0 auto-mapped to 1)
   MB/TCP Exception Codes ..... Yes (return 00AH and 00BH)
   Char, Message Timeout ..... 00050msec, 05000msec

D)default settings, S)ave, Q)uit without save
Select Command or parameter set (1..4) to change:

```

Figure 3-9. Modbus-TCP Set up Screen

2. Enter **1** to manually configure IP Address, Default Gateway Address and Netmask.
3. Enter **S** to save.



**NOTE:** Modbus-TCP commands and registers are the same as Modbus-RTU protocol. For more information, see [Section 3.12 on page 61](#).

## 3.12 Modbus-RTU Protocol

The MODBUS-RTU protocol enables management of the reading and writing of the registers, listed in this section, according to the specifications contained in the reference document for this standard Modicon PI-MBUS-300.

To select the communication with MODBUS-RTU, see [Section 2.5 on page 31](#).

When specifically indicated, certain data will be written directly to EEPROM type memories. This memory has a limited number of writing operations (100.000); therefore, unnecessary operations at said locations must be avoided. The instrument ensures that no writing occurs if the value to be stored is equal to the stored value.

The numerical data listed below are expressed in decimal notation, or hexadecimal notation if preceded by 0x.

### Modbus-RTU Data Format

The data received and transmitted via MODBUS-RTU protocol have the following characteristics:

- 1 start bit
- 8 data bits, least significant bit sent first
- Instrument settable parity bit
- Instrument settable stop bit

## Modbus Supported Functions

Among the commands available in MODBUS-RTU protocol, only the commands in [Table 3-27](#) are used to manage communication with the instruments. Other commands may not be interpreted correctly and could generate errors or system shut-downs:

Function	Description
03 (0x03)	Read Holding Register (Programmable Register Reading)
16 (0x10)	Preset Multiple Registers (Multiple Register Writing)

Table 3-27. Modbus-RTU Supported Functions

The interrogation frequency is linked with the preset communication rate (the SCT20-MB will stand by for at least 3 bytes before beginning to calculate a possible response to the query). The *DELAY* parameter ([Section 2.5 on page 31](#)) allows for a further delay in the instrument response, and this directly influences the number of possible queries in the unit of time.

For additional information on this protocol, refer to the general technical specification PI\_MBUS\_300. In general, the query and response to and from a source instrument are organized as follows.

### Function 3: Read Holding Registers (Programmable Register Reading)

QUERY				
Address	Function	Add. Reg. 1	No. register	2 bytes
A	0x03	0x0000	0x0002	CRC

Table 3-28. Programmable Register Reading (Modbus-RTU)

Tot. bytes = 8

RESPONSE					
Address	Function	No. bytes	Register1	Register 2	2 bytes
A	0x03	0x04	0x0064	0x00C8	CRC

Table 3-29. Programmable Register Reading Response (Modbus-RTU)

Tot. bytes = 3+2\*No. registers+2

In which:

No. registers= number of Modbus register to be read, starting from the Address 1° register

No. bytes = number of data bytes to follow

### Function 16: Preset Multiple Registers (Multiple Register Writing)

QUERY							
Address	Function	Add. reg. 1	No. reg.	No. bytes	Val. reg.1	Val. reg.2	2 bytes
A	0x10	0x0000	0x0002	0x04	0x0000	0x0000	CRC

Table 3-30. Multiple Register Writing Query (Modbus-RTU)

Tot. bytes = 7+2\*No. registers+2

RESPONSE				
Address	Function	Add. Reg. 1	No. register	2 bytes
A	0x10	0x0000	0x0002	CRC

Table 3-31. Multiple Register Writing Response (Modbus-RTU)

Tot. bytes = 8

In which:

No. registers= number of Modbus register to be read, starting from the Address 1° register;

No. bytes = number of data bytes to follow;

Val. reg. 1 = register contents beginning from the first.

The response contains the number of records changed starting from the Address 1° register.

## Communication Error Management

The communication strings are controlled by CRC (Cyclical Redundancy Check).

In the event of a communication error, the source will not respond with any string. The primary must allow for a time-out before response reception. If no response is received, it infers that a communication error has occurred.

In the event of a string received correctly but not executable, the source responds with an Exceptional Response. The function field is transmitted with the msb at 1.

EXCEPTIONAL RESPONSE			
Address	Function	Code	2 bytes
A	Funct + 0x80	See <a href="#">Table 3-33</a>	CRC

Table 3-32. Exceptional Response (Modbus-RTU)

CODE	DESCRIPTION
1	ILLEGAL FUNCTION (Function not valid or not supported)
2	ILLEGAL DATA ADDRESS (The specified data address is not available)
3	ILLEGAL DATA VALUE (The data received have no valid value)

Table 3-33. Exceptional Response Codes (Modbus-RTU)

## List Of Usable Registers

The MODBUS-RTU and MODBUS-TCP protocol implemented on this instrument can manage a maximum of 32 registers read and written in a single query or response.

- R** = the register can be read only
- W** = the register can be written only
- R/W** = the register can be both read and written
- H** = high half of the DOUBLE WORD forming the number
- L** = low half of the DOUBLE WORD forming the number

REGISTER	DESCRIPTION	Saving to EEPROM	ACCESS
40001	Firmware version	—	R
40002	Type of instrument	—	R
40003	Year of Production	—	R
40004	Serial Number	—	R
40005	Active program	—	R
40006	COMMAND REGISTER	NO	W
40007	STATUS REGISTER	—	R
40008	GROSS WEIGHT H	—	R
40009	GROSS WEIGHT L	—	R
40010	NET WEIGHT H	—	R
40011	NET WEIGHT L	—	R
40012	PEAK WEIGHT H	—	RR
40013	PEAK WEIGHT L	—	R
40014	Divisions and Units of measure )	—	R
40015	Coefficient H	—	R
40016	Coefficient L	—	R

Table 3-34. Usable Registers (Modbus-RTU)

REGISTER	DESCRIPTION	Saving to EEPROM	ACCESS
40017	Setpoint 1 H	Only after command '9' of the COMMAND REGISTER	R/W
40018	Setpoint 1 L		R/W
40019	Setpoint 2 H		R/W
40020	Setpoint 2 L		R/W
40021	Setpoint 3 H		R/W
40022	Setpoint 3 L		R/W
40023	Hysteresis 1 H		R/W
40024	Hysteresis 1 L		R/W
40025	Hysteresis 2 H	R/W	—
40026	Hysteresis 2 L	R/W	—
40027	Hysteresis 3 H	R/W	—
40028	Hysteresis 3 L	R/W	—
40029	Inputs	—	R
40030	OutputS	NO	R/W
40037	Test weight for calibration H	Use with command '101' of the COMMAND REGISTER	R/W
40038	Test weight for calibration L		R/W
40043	Weight value corresponding to ZERO of the analog output H	Only after command '99' of the Command Register. (Analog Models Only)	R/W
40044	Weight value corresponding to ZERO of the analog output L		R/W
40045	Weight value corresponding to Full Scale of the analog output H		R/W
40046	Weight value corresponding to Full Scale of the analog output L		R/W

Table 3-34. Usable Registers (Modbus-RTU) (Continued)



**IMPORTANT:** At the time of writing, the setpoints, hysteresis values are saved to the RAM and will be lost upon the next power-off; to store them permanently to the EEPROM so that they are maintained at power-on, the '99' command of the Command Register must be sent.

### Weight (Span) Calibration Commands (With Test Weights)

The SCT20-MB calibration can be changed via Modbus. To perform this procedure, the system must be unloaded and the weight value display reset to zero with the command 100 of the Command Register. A load must then be placed on the system and the correct weight value must be sent to the registers 40037-40038. To save this value, send the control 101 from the Command Register. If the operation is completed successfully, the two test weight registers are set to zero.

### Analog Output Setting (Analog Models Only)

Write the weight in the registers 40045 (Weight value corresponding to the Full Scale of analog output H) and 40046 (Weight value corresponding to the Full Scale of analog output L), or write the weight in the registers 40043 (Weight value corresponding to the ZERO of the analog output H) and 40044 (Weight value corresponding to the ZERO of the analog output L). After writing the value, send the command 99 from the Command Register to save it to EEPROM memory.



### 3.12.1 Access to Legally Relevant Parameters Commands

To modify legally relevant parameters and be able to change the instrument calibration via Modbus, use the following procedure (a customer password table is required, contact the manufacturer or authorized service center):

1. Type the user password in the *Identification code / Password* register.
2. Send command 120 to the *Command Register*.
3. Read the password seed in the *Password seed* register.
4. Enter the password read in the password table in the *Identification code / Password* register.
5. Send command 121 to the *Command Register*.

If the operation is successfully completed the *Identification code / Password* and *Password seed* registers are set to zero. It is now possible to perform calibration operations (see [Section 3.8.1 on page 52](#)).

Status Register (40007)			
Bit 0	Cell Error	Bit 8	Net weight negative sign
Bit 1	AD Convertor Malfunction	Bit 9	Peak weight negative sign
Bit 2	Maximum weight exceeded by 9 divisions	Bit 10	Net display mode
Bit 3	Gross weight higher than 110% of full scale	Bit 11	Weight stability
Bit 4	Gross weight beyond 999999 or less than -999999	Bit 12	Weight within +/-¼ of a division around ZERO
Bit 5	Net weight beyond 999999 or less than -999999	Bit 13	—
Bit 6	—	Bit 14	—
Bit 7	Gross weight negative sign	Bit 15	—

Table 3-35. Status Register (40007) (Analog Model)

INPUTS REGISTER (40029) (Read Only)		OUTPUTS REGISTER (40030) (Read and Write)	
Bit 0	INPUT 1 Status	Bit 0	OUTPUT 1 Status
Bit 1	INPUT 2 Status	Bit 1	OUTPUT 2 Status
Bit 2	—	Bit 2	OUTPUT 3 Status
Bit 3	—	Bit 3	—
Bit 4	—	Bit 4	—
Bit 5	—	Bit 5	—
Bit 6	—	Bit 6	—
Bit 7	—	Bit 7	—
Bit 8	—	Bit 8	—
Bit 9	—	Bit 9	—
Bit 10	—	Bit 10	—
Bit 11	—	Bit 11	—
Bit 12	—	Bit 12	—
Bit 13	—	Bit 13	—
Bit 14	—	Bit 14	—
Bit 15	—	Bit 15	—

Table 3-36. Input and Output Registers (Analog Model)



**NOTE:** The output status can be read at any time but can be set (written) only if the output has been set as NOdbUS or dEUnEt ([Section 2.11 on page 39](#)); otherwise, the outputs will be managed according to the current weight status with respect to the relevant setpoints.

### Divisions And Units Measure Registry (40014)

This register contains the current settings of the divisions parameter ( $d$ , 0-15) and the units of measure parameter ( $u$ , 0-11). Use this register together with the  $COEFF$  registers to calculate the value displayed by the SCT20-MB.

Least significant byte L Byte (Division)			Most significant byte H Byte (Units of Measure)		
Division value	Divisor	Decimals	Units of measure value	Units of measure description	Utilization of the Coefficient value with the different units of measure settings compared to the gross weight detected
0	100	0	0	Kilograms	Does not intervene
1	50	0	1	Grams	Does not intervene
2	20	0	2	Tons	Does not intervene
3	10	0	3	Pounds	Does not intervene
4	5	0	4	Newton	Multiples
5	2	0	5	Litres	Divides
6	1	0	6	Bar	Multiples
7	0.5	1	7	Atmspheres	Multiples
8	0.2	1	8	Pieces	Divides
9	0.1	1	9	Newton Meter	Multiples
10	0.05	2	10	Kilogram Meter	Multiples
11	0.02	2	11	Other	Multiples
12	0.01	2			
13	0.005	3			
14	0.002	3			
15	0.001	3			
16	0.0005	4			
17	0.0002	4			
18	0.0001	4			

Table 3-37. Divisions and Units of Measure (Analog Model)

### Possible Commands To Send To The Command Register (40006)

Code	Descriptions	Code	Description
0	No command	17	Reserved
1	—	18	Reserved
2	—	19	—
3	—	20	—
4	—	21	Keypad lock
5	—	22	Keypad and display unlock
6	—	23	Keypad and display lock
7	NET display	24	—
8	SEMI-AUTOMATIC ZERO	99	Save data in EEPROM
9	GROSS display	100	Zero-setting for calibration
10	Reserved	101	Test weight storage for calibration
11	Reserved		—
12	Reserved		—
13	Reserved		—
14	Reserved		—
15	Reserved		—
16	Reserved	9999	Reset (reserved)

Table 3-38. Commands to Command Register (Analog Model)

### 3.13 ASCII Bidirectional Protocol



**NOTE:** All the sample commands use address 1. If a different address is used it will need a different Check-Sum calculated.

The instrument replies to the requests sent from a PC/PLC.

Using the *dELAY* parameter, it is possible to set a delay time for the instrument before it transmits a response. See [Section 2.5 on page 31](#).

The following communication modes available ([Section 2.5 on page 31](#)):

- `n0du60:`
- `?n0d td:?`

#### Data Identifiers

Data Sent	Definition
\$	Beginning of a request string (36 ASCII)
& o &&	Beginning of a response string (38 ASCII)
aa	2 characters for instrument address (48 ÷ 57 ASCII)
!	1 character to indicate the correct reception(33 ASCII)
?	1 character to indicate a reception error (63 ASCII)
#	1 character to indicate an error in the command execution (23 ASCII)
ckck	2 ASCII characters for Check-Sum ( <a href="#">page 71</a> )
CR	1 character for string end (13 ASCII)
\	1 character for separation (92 ASCII)

Table 3-39. Data Identifiers (ASCII)

#### Setpoint Values Setting:

The PC transmits: `$aaxxxxxyckckCR` in which:

Data	Definition
xxxxxx	6 characters for the setpoint value (48 ? 57 ASCII)
y	A (set the value in the Setpoint 1) <code>\$01010000A40CR</code>
y	B (set the value in the Setpoint 2) <code>\$01010000B42CR</code>
y	C (set the value in the Setpoint 3) <code>\$01010000C43CR</code>

Table 3-40. Setpoint Value Definitions (ASCII)

Possible instrument responses:

- Correct reception: `&&aa!\ckckCR`
- Incorrect reception: `&&aa?\ckckCR`

#### Setpoints Storage Into EEPROM Memory:

The setpoints value relevant to the two setpoints programmed via the PC are stored to the RAM volatile memory and lost upon instrument power off. It is necessary to send a special command to save them permanently in the EEPROM memory. Please note that the number of writes allowed in the EEPROM memory is limited (about 100000).

The PC transmits: `$aaMEMckckCR$01MEM44CR`

Possible instrument responses:

- Correct reception: `&&aa!\ckckCR`
- Incorrect reception: `&&aa?\ckckCR`

**Reading Weight, The Setpoint And The Peak (If Present) From The Pc:**

The PC transmits: **\$aa`jkck`CR**

Data	Definitions
j	a to read setpoint 1\$01a60CR
j	b to read setpoint 2\$01b63CR
j	c to read setpoint 3\$01c62CR
j	t to read gross weight\$01t75CR
j	n to read net weight\$01n6FCR
j	p to read the gross weight peak if the ASCII parameter is set as NOdU60; if the ASCII parameter is set on NOd td the gross weight will be read.

Table 3-41. Weight, Setpoint, Peak Definitions (ASCII)

To read the points, set the `FS_L` equal to 50000. `$01p71CR`

Possible instrument responses:

- Correct reception: **&aa`xxxxxj`\ckckCR**; in which `xxxxxx` = 6 value characters of the required weight
- Incorrect reception: **&&aa?`jkck`CR**
- If the peak is not configured: **&aa#CR**



**NOTE:** In the event of negative weight, the first character on the left acquires the value « - » (minus sign - ASCII 45). In the event the weight value is under -99999, the minus sign ('-') is sent alternated with the most significant figure.

**Error messages**

In the event of an instrument alarm for exceeding 110% of the full scale or nine divisions above the value of the parameter `NR55`, the instrument sends the string **&aassO-Lst\ckck**; in which: `s` = 1 separator character (32 ASCII – space-).

In the event of a faulty connection of the load cells or other alarm, the instrument sends **&aassO-Fst\ckck**; in which: `s` = 1 separator character (32 ASCII – space-).

See [Section 3.6 on page 45](#) for more information on alarms.

**Semi-Automatic Zero (Weight Zero-Setting For Small Variations)**

**IMPORTANT:** The zero-setting will not be maintained after an instrument power-off.

The PC transmits: **\$aaZEROckckCR\$01ZERO03CR**

Possible instrument responses:

- Correct reception: **&&aa\ckckCR**
- Incorrect reception: **&&aa?`jkck`CR**
- The current weight is over the maximum value resettable: **&aa#CR**

**Switching From Gross Weight To Net Weight**

The PC transmits: **\$aaNETckckCR\$01NET5ECR**

Possible instrument responses:

- Correct reception: **&&aa\ckckCR**
- Incorrect reception: **&&aa?`jkck`CR**

**Switching From Net Weight To Gross Weight**

The PC transmits: **\$aaGROSSckckCR\$01GROSS5BCR**

Possible instrument responses:

- Correct reception: **&&aa\ckckCR**
- Incorrect reception: **&&aa?`jkck`CR**

**Reading Of Decimals And Number Of Divisions**

The PC transmits: **\$aaDckckCR\$01D45CR**

Possible instrument responses:

- Correct reception: **&aaxy\ckckCR**

Response Value	Definition
x	number of decimals
y	division value
The y field acquires the following values:	
3	for division value = 1
4	for division value = 2
5	for division value = 5
6	for division value = 10
7	for division value = 20
8	for division value = 50
9	for division value = 100

Table 3-42. Decimal and Division Definitions

- Incorrect reception: **&&aa?\ckckCR**

### Tare Weight Zero Setting

The PC transmit the following ASCII string containing the zeroing command:

- **\$aazckckCR\$01z7BCR**; in which: **z** = weight zeroing command (122 ASCII)

Possible instrument responses:

- Correct reception: **&aaxxxxxt\ckckCR**

Data	Definition
xxxxxx	6 characters for the required weight value.
t	weight identification code (116 ASCII).

Table 3-43. Zeroing Command String Definition

- Incorrect reception: **&&aa?\ckckCR**
- If the instrument is not in gross weight displaying condition, the response is: **&aa#CR**

**Example:** Weight zero setting for instrument with address 2:

For the calibration, make sure that the scale is empty and the instrument measures a corresponding mV signal.

query: **\$02z78(Cr)**      response: **&02000000t\76(Cr)**

For a correct weight zero setting the read value (response) must be 0 (in the string 000000).

 **IMPORTANT:** The zero values are stored to the EEPROM memory. Please note that the number of writes allowed is limited (about 100000). If it is necessary to reset the weight quite often, it is recommended to perform it by PC or PLC program, keeping in mind the weight deviation respect to the zero instrument.

### Weight (Span) Calibration (With Test Weights)

After having performed the Tare Weight Zero Setting, this function allows correct calibration to be done using test weights of known value and, if necessary, any deviations of the indicated value from the known value will be corrected.

Load the test weight onto the scale using as high a percentage of the maximum quantity to be weighed as possible. Otherwise make sure that the instrument measures a corresponding mV signal.

The PC sends the following ASCII string containing the calibration command:

**\$aasxxxxxckckCR** in which:

Data	Definition
s	calibration command (115 ASCII)
xxxxxx	6 characters for test weight value.

Table 3-44. Calibration Command String Definitions

Possible instrument responses:

- Correct reception: **&aaxxxxxt\ckckCR**

Data	Definition
t	gross weight identification code (116 ASCII).
xxxxxx	6 characters to indicate the current weight value.

Table 3-45. Calibration Response Definitions

- Incorrect reception or full scale equal to zero: **&&aa?\ckckCR**

For correct calibration, the read value must be equal to test weight.

**Example:** Calibration for instrument with address 1 and test weight of 20000 kg:

query: **\$01s02000070(Cr)** response: **&01020000t\77(Cr)**

For correct calibration the read value will be 020000.

### Keypad Lock (Access Protection To The Instrument)

The PC transmits: **\$aaKEYckckCR\$01KEY56CR**

Possible instrument responses:

- Correct reception: **&&aa!\ckckCR**
- Incorrect reception: **&&aa?\ckckCR**

### Keypad Unlock

The PC transmits: **\$aaFREckckCR\$01FRE50CR**

Possible instrument responses:

- Correct reception: **&&aa!\ckckCR**
- Incorrect reception: **&&aa?\ckckCR**

### Display And Keypad Lock

The PC transmits: **\$aaKDISckckCR\$01KDIS14CR**

Possible instrument responses:

- Correct reception: **&&aa!\ckckCR**
- Incorrect reception: **&&aa?\ckckCR**

### Check-Sum Calculation

The two ASCII control characters (**ckck**) are the representation of a hexadecimal digit in ASCII characters. The check digit is calculated by performing the operation XOR (exclusive or) 8-bit ASCII codes of the only part of the underlined string.

The procedure to calculate the check-sum is the following:

- Consider only the string characters highlighted with underlining;
- Calculate the EXCLUSIVE OR (XOR) of the ASCII codes for the characters;

Example:

Character	Decimal ASCII Code	Hexadecimal ASCII Code	Binary ASCII Code
0	48	30	00110000
1	49	31	00110001
t	116	74	01110100
XOR =	117	75	01110101

Table 3-46. Example Check Sum Calculation (ASCII)

The result of the XOR operation expressed in hexadecimal notation is made up of 2 hexadecimal digits (numbers from 0 to 9 or letters from A to F). In this case the hexadecimal code is 0x75.

The check-sum inserted in the strings transmitted is made up of the 2 characters which represent the result of the XOR operation in hexadecimal notation (in this example the character 7 and the character 5).

## 3.14 Fast Continuous Transmission Protocol

This protocol allows for continuous serial output at high update frequencies. Up to 300 strings per second are transmitted (with a minimum transmission rate of 38400 baud).

The communication modes available are (Section 2.5 on page 31):

- $n\bar{0}d\ \bar{t}$ : communication compatible with TX RS-485 instruments.?
- $n\bar{0}d\ \bar{t}d$ : communication compatible with TD RS-485 instruments.?

If  $n\bar{0}d\ \bar{t}$  is set, the following string is transmitted to PC/PLC: **xxxxxxCRLF.**:

String Character	Definition
xxxxxx	6 ASCII characters for gross weight (48 ÷ 57 ASCII)
CR	1 character of carriage return (13 ASCII)
LF	1 character of line feed (10 ASCII)

Table 3-47.  $n\bar{0}d\ \bar{t}$  Communication String Definitions

In the event of negative weight, the first character on the left acquires the value « - » (minus sign - ASCII 45).

In the event of error or alarm, the 6 weight characters are replaced by the messages found in Table 3-2 on page 46.

If  $n\bar{0}d\ \bar{t}d$  is set, the following string is transmitted to PC/PLC: **&TzzzzzzPzzzzzz\ckckCR**

Data	Definition
&	1 character of string start (38 ASCII).
T	reference character for gross weight.
P	reference character for gross weight.
zzzzzz	6 ASCII characters for gross weight (48 ? 57 ASCII).
\	1 character of separation (92 ASCII).

Table 3-48.  $n\bar{0}d\ \bar{t}d$  Communication String Definitions

Data	Definition
ckck	2 ASCII control characters calculated considering that the characters between <b>&amp;</b> and <b>\</b> are excluded. The control value is obtained by carrying out the XOR (or exclusive) operation for the 8 bit ASCII codes of the characters considered. A character expressed in hexadecimal is thus obtained, with 2 digits which may acquire values from <b>0</b> to <b>9</b> and from <b>A</b> to <b>F</b> . <b>ckck</b> is the ASCII code of the two hexadecimal digits.
CR	1 character for string end (13 ASCII).

Table 3-48. *Communication String Definitions (Continued)*

In the event of negative weight, the first character on the left acquires the value « - » (minus sign - ASCII 45).

In the event of error or alarm, the 6 gross weight characters are replaced by messages. See [Table 3.6 on page 45](#).

**Fast Transmission Via External Contact:** A single string can be transmitted by closing a digital input, not exceeding 1 sec. See [Section 2.5 on page 31](#) and [Section 2.11 on page 39](#).

### 3.15 Continuous Transmission Protocol

Using this protocol, the instrument transmits, in continuous mode, the weight to remote displays; the communication string is transmitted 10 times per second. The communication modes available are ([Section 2.5 on page 31](#)):

- *rL P*: remote display shows the net or gross weight, depending on the remote display setting.
- *hdrL P*: remote display shows the net or gross weight, depending on the remote display setting.
- *hdrL Pn*:

The instrument sends the following string to the remote display:

- **&NxxxxxLyyyyy\ckckCR**

Data	Definition
&	1 character of string start (38 ASCII)
N	1 reference character for net weight. (78 ASCII)
xxxxxx	6 ASCII characters for net or peak weight if present (48 ÷ 57 ASCII)
L	1 reference character for gross weight (76 ASCII)
yyyyyy	6 ASCII characters for gross weight (48 ? 57 ASCII).
\	1 character for separation (92 ASCII)
ckck	2 ASCII control characters calculated considering that the characters between <b>&amp;</b> and <b>\</b> are excluded. The control value is obtained by carrying out the XOR (or exclusive) operation for the 8 bit ASCII codes of the characters considered. character expressed in hexadecimal is thus obtained, with 2 digits which may acquire values from <b>0</b> to <b>9</b> and from <b>A</b> to <b>F</b> . <b>ckck</b> is the ASCII code of the two hexadecimal digits.
CR	character for string end (13 ASCII).

Table 3-49. *Continuous Transmission Protocol Data Definitions*

In the event of negative weight, the first character on the left acquires the value « - » (minus sign - ASCII 45).

If the protocol on *hdrL P* has been set, the decimal point at the position shown on the instrument's display can also be transmitted. In this case, if the value exceeds 5 digits, only the 5 most significant digits are transmitted, while if the value is negative, no more than the 4 most significant digits are transmitted. In both cases, however, the decimal point shifts consistently with the value to display.

If *hdrL Pn* has been set, in addition to what is stated in *hdrL P* protocol, the instrument transmits the prompt net every 4 seconds in the gross weight field, when the instrument is in net mode. See [Section 3.1 on page 44](#).

In case weight value is under -99999, the minus sign (-) is sent alternated with the most significant figure.

In the event of error or alarm, the 6 characters of the gross and net weight are replaced by the messages found in [Table 3.6 on page 45](#).



## 3.16 Interface to Remote Display

### Remote Display (LaserLight)

1. Press and hold **←**, then press **✕**. **CR L ib** is displayed.
2. Press **◀** or **▶** until **5Er iRL** is displayed.
3. Press **←**. **r54B5** is displayed.
4. Press **←**. **n0nE** is displayed.
5. Press **◀** or **▶** until **r iP** is displayed. Press **←**.
6. Press **✕** twice to exit set-up menu.

LaserLight  
E CHAR = CR  
LWPOS = 7  
LENGTH = 19

Laser Light		SCT
Connector	Pin	Connector
J8 (RS-232)	3	RS-485 RX-
	5	RS-485 RX+

Table 3-50. Laser Light Setup

LaserLight 1550  
S CHAR = SoH  
LWPOS = 000008

## 3.17 Communication Examples

The numerical data below are expressed in hexadecimal notation with prefix h.

Example 1: Command for multiple writing of registers (hexadecimal command 16, h10)

Assuming that we wish to write the value 0 to the register 40017 and the value 2000 to the register 40018, the string to generate must be:

h01 h10 h00 h10 h00 h02 h04 h00 h00 h07 hD0 hF1 h0F

The instrument will respond with the string:

h01 h10 h00 h10 h00 h02 h40 h0D

Query Field Name	Hex	Response Field Name	Hex
Instrument Address	h01	Instrument Address	h01
Function	h10	Function	h10
Address of the first register H	h00	Address of the first register H	h00
Address of the first register L	h10	Address of the first register L	h10
Number of registers to send H	h00	Number of registers H	h00
Number of registers to send L	h02	Number of registers L	h02
Byte Count	h04	CRC16 H	h40
Datum 1 H	h00	CRC16 L	h0D

Table 3-51. Communication Example 1

Query Field Name	Hex	Response Field Name	Hex
Datum 1 L	h00		
Datum 2 H	h07		
Datum 2 L	hD0		
CRC16 H	hF1		
CRC16 L	h0F		

Table 3-51. Communication Example 1 (Continued)

Example 2: Command for multiple writing of registers (hexadecimal command 16, h10).

Assuming that we wish to write the two setpoint values on the instrument, at 2000 and 3000 respectively, the string must be sent:

h01 h10 h00 h10 h00 h04 h08 h00 h00 h07 hD0 h00 h00 h0B hB8  
hB0 hA2

The instrument will respond with the string:

h01 h10 h00 h10 h00 h04 hC0 h0F

Query Field Name	Hex	Response Field Name	Hex
Instrument Address	h01	Instrument Address	h01
Function	h10	Function	h10
Address of the first register H	h00	Address of the first register H	h00
Address of the first register L	h10	Address of the first register L	h10
Number of registers to send H	h00	Number of registers H	h00
Number of registers to send L	h04	Number of registers L	h04
Byte Count	h08	CRC16 H	hC0
Datum 1 H	h00	CRC16 L	h0F
Datum 1 L	h00		
Datum 2 H	h07		
Datum 2 L	hD0		
Datum 3 H	h00		
Datum 3 L	h00		
Datum 4 H	h0B		
Datum 4 L	hB8		
CRC16 H	hB0		
CRC16 L	hA2		

Table 3-52. Communication Example 2

Example 3: Multiple command reading for registers (hexadecimal command 3, h03).

Assuming that we wish to read the two gross weight values (in the example 4000) and net weight values (in the example 3000), reading from address 40008 to address 40011 must be performed by sending the following string:

H01 h03 h00 h07 h00 h04 hF5 hC8

The instrument will respond with the string:



H01 h03 h08 h00 h00 hF hA0 h00 h00 h0B hB8 h12 h73

Query Field Name	Hex	Response Field Name	Hex
Instrument Address	h01	Instrument Address	h01
Function	h03	Function	h03
Instrument Address	h01	Instrument Address	h01
Function	h03	Function	h03
Address of the first register H	h00	Address of the first register H	h08
Address of the first register L	h07	Address of the first register L	h00
Number of registers to send H	h00	Datum 1 H	h00
Number of registers to send L	h04	Datum 1 L	h00
CRC16 H	hF5	Datum 2 H	h0F
CRC16 L	hC8	Datum 2 L	hA0
		Datum 3 H	h00
		Datum 3 L	h00
		Datum 4 H	h0B
		Datum 4 L	hB0
		CRC16 H	h12
		CRC16 L	h73

Table 3-53. Communication Example 3

For additional examples regarding the generation of correct control characters (CRC16) refer to the manual **Modicon PI-MBUS-300**.

## 4.0 Compliance

	<b>EU DECLARATION OF CONFORMITY</b> <small>EU-KONFORMITÄTSERKLÄRUNG DÉCLARATION UE DE CONFORMITÉ</small>		Rice Lake Weighing Systems 230 West Coleman Street Rice Lake, Wisconsin 54868 United States of America 
	<b>Type/Typ/Type:</b> SCT-10, SCT-20, SCT-30, SCT-40		
English	We declare under our sole responsibility that the products to which this declaration refers to, is in conformity with the following standard(s) or other regulations document(s).		
Deutsch	Wir erklären unter unserer alleinigen Verantwortung, dass die Produkte auf die sich diese Erklärung bezieht, den folgenden Normen und Regulierungsbestimmungen entsprechen.		
Français	Nous déclarons sous notre responsabilité que les produits auxquels se rapporte la présente déclaration, sont conformes à la/aux norme/s suivante ou au/aux document/s normatif/s suivant/s.		
EU Directive	Certificates	Standards Used / Notified Body Involvement	
2014/35/EU low voltage	-	EN 61010-1:2010 for 230/115 VAC type	
2014/30/EU EMC	-	EN 55011:2016+A1+A11:2020 EN 61000-6-2:2019 EN 61000-6-4:2019 EN 61000-4-2:2009 EN 61000-4-3:2006+A2:2010 EN 61000-4-4:2012 EN 61000-4-5:2014+A1:2017 EN 61000-4-6:2014	
2011/65/EU RoHS	-	EN 50581:2012	
Signature: <u>Brandi Harder</u>	Place: <u>Rice Lake, WI USA</u>		
Name: <u>Brandi Harder</u>	Date: <u>February 4, 2022</u>		
Title: <u>Quality Manager</u>			



## UK DECLARATION OF CONFORMITY

Rice Lake Weighing Systems  
230 West Coleman Street  
Rice Lake, Wisconsin 54868  
United States of America

**RICE LAKE**  
WEIGHING SYSTEMS

**Type:** SCT-10, SCT-20, SCT-30, SCT-40

English We declare under our sole responsibility that the products to which this declaration refers to, is in conformity with the following standard(s) or other regulations document(s).

UK Regulations	Certificates	Standards Used / Approved Body Involvement
2016/1101 Low Voltage	-	EN 61010-1:2010 for 230/115 VAC type
2016/1091 EMC	-	EN 55011:2016+A1+A11:2020 EN 61000-6-2:2019 EN 61000-6-4:2019 EN 61000-4-2:2009 EN 61000-4-3:2006+A2:2010 EN 61000-4-4:2012 EN 61000-4-5:2014+A1:2017 EN 61000-4-6:2014
2012/3032 RoHS	-	EN 50581:2012

Signature: Brandi Harder

Place: Rice Lake, WI USA

Name: Brandi Harder

Date: February 4, 2022

Title: Quality Manager

## 5.0 Specifications

### Power DC

Power Supply and Consumption (VDC) 12/24 VDC  $\pm$  10%; 5W

### Operator Interface

Display STN backlight transmissive LCD  
128 x 64 pixel resolution  
2.36 x 1.26 in (60 x 32 mm) viewing area  
0.3 in (8mm), seven segment LED

Keypad 4-key membrane panel, tactile feel

### Analog Output

Opto-isolated Analog Output 0-20 mA; 4-20 mA (max 300 ohm;  
0-10 VDC; 0  $\pm$ ; 0-5 VDC;  $\pm$ 10 VDC;  
16 bit - 65535 divisions  $\pm$  5 VDC (min 10 kohm)

### Enclosure

Dimensions (W x H x D) 0.98 x 4.52 x 4.72 in  
(25 x 115 x 120 mm)

### Communications

EtherNet/IP™ Port RJ45 10Base - T or  
100Base-TX (auto-sensing)

#### PROFIBUS Port:

Baud Rate up to 12 Mbit/s  
Addresses 1-99

#### DeviceNet™ Port:

Baud Rate 125kbit/s, 250kbit/s, 500kbit/s  
Addresses 1.63

Modbus-TCP Port RJ45 10Base-TX (auto-sensing)

Number of Load Cells in parallel and Supply Max 8 (350 ohm); 5 VDC/ 120 mA

Linearity/ Analog Output Linearity <0.01% F.S.; <0.01% F.S./°C

Thermal Drift <0.0005% F.S./°C;  
<0.003% F.S./°C (Analog Only)

A/D Converter 24 bit (16,000,000 points)

Max Divisions (with Measurement Range  $\pm$  10 mV = Sensitivity 2mV/V)  $\pm$ 999999

Measurement Range  $\pm$ 39 mV

Max Sensitivity of Usable Load Cells  $\pm$ 7 mV/V

Max Conversions per second 300/second

Display Range  $\pm$ 999999

Number of Decimals/ Display Increments 0-4/ x 1 x 2 x 5 x 10 x 20 x 50 x 100

Digital Filter/Readings 0.060-7sec/5-300 Hz  
(Analog, per second DeviceNet™)  
0.012-7 sec/5-300 Hz (Ethernet, PROFIBUS)

Relay Logic Outputs N.3 - max 115 VAC; 150 mA

Logic Inputs N.2 - opto-isolated 5 - 24 VDC PNP

Serial Ports RS-485 (RS232)

Baud Rate 2400, 4800, 9600, 19200, 38400, 115200

### Environmental

Operating Temperature -4°F to 140°F (-20°C to 60°C)  
Storage Temperature -22°F to 176°F (-30°C to 80°C)  
Humidity 85% (Non Condensing)

### Certifications and Approvals



**NTEP**

CC Number 14-083

Accuracy Class: III;  $n_{max}$ : 5000



**UL Recognized**







© Rice Lake Weighing Systems Content subject to change without notice.

230 W. Coleman St. • Rice Lake, WI 54868 • USA USA: 800-472-6703 • International: +1-715-234-9171