

# PROFINET<sup>®</sup> Ethernet/IP<sup>™</sup> Modbus TCP/IP<sup>®</sup> Quick Setup Guide

## Electrical Diagram

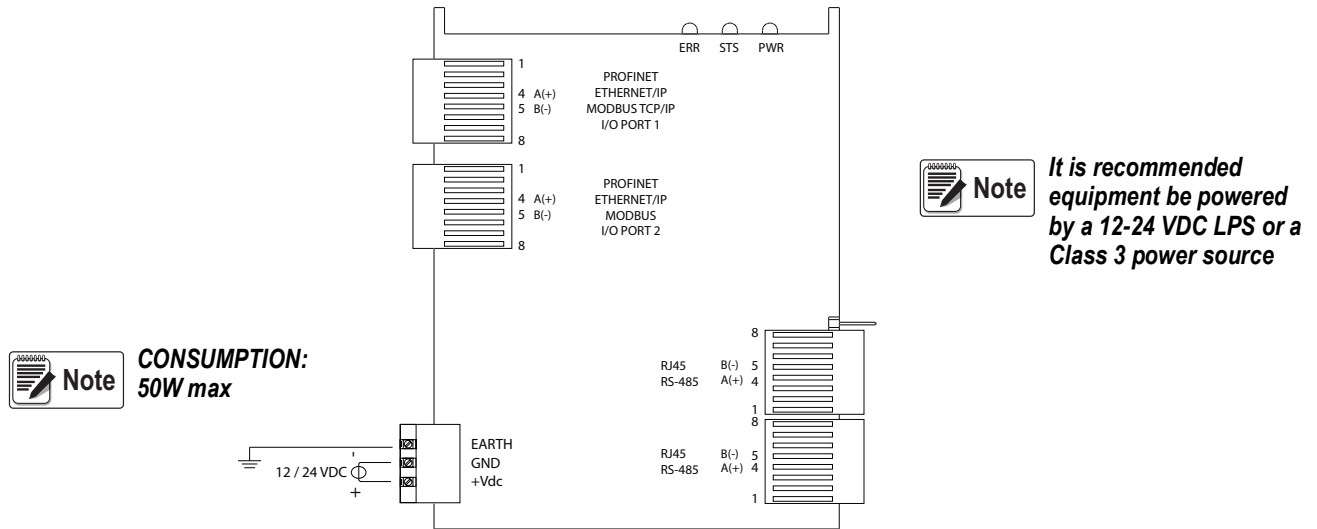

## Module Connection to SCT-2200 Transmitters

Use the RJ45 and RS-485 directional ports to connect the PROFINET, Ethernet/IP or Modbus TCP/IP Fieldbus Module to one or more SCT-2200

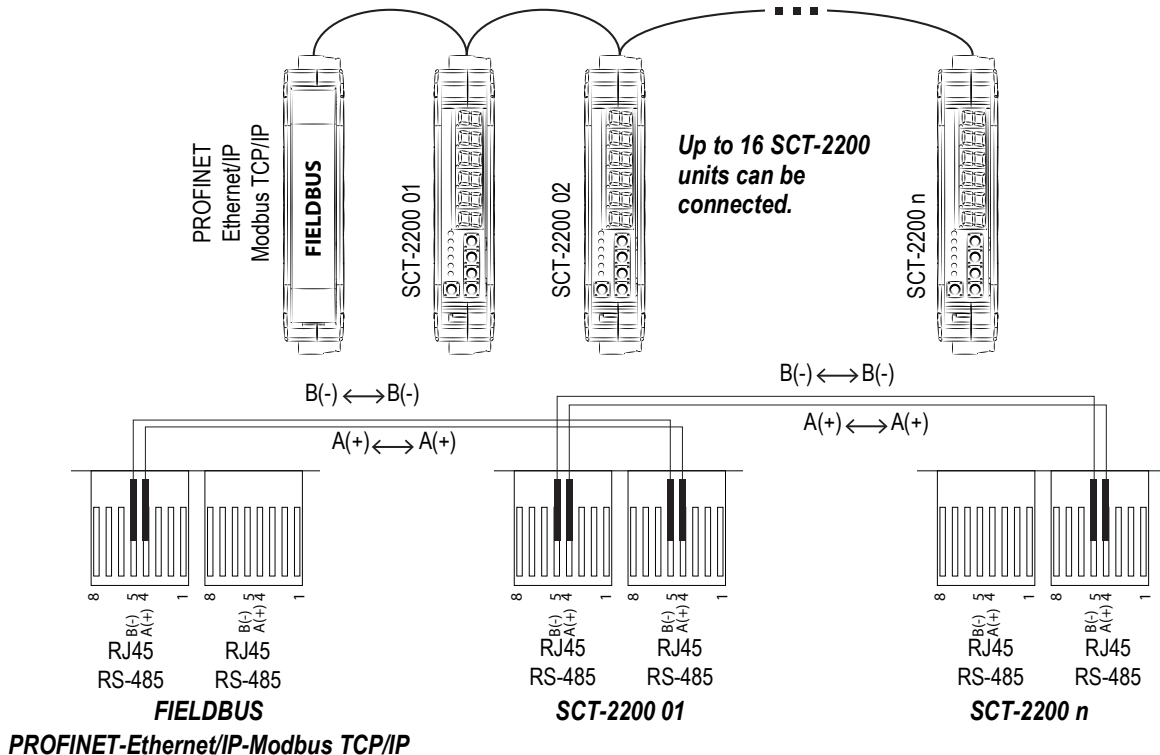

## Configuration

The weight transmitter menu is used to configure the PROFINET, Ethernet/IP, or Modbus TCP/IP Module.

1. Reboot the weight transmitter.
2. Press the  key while the display check is in progress to access the menu:

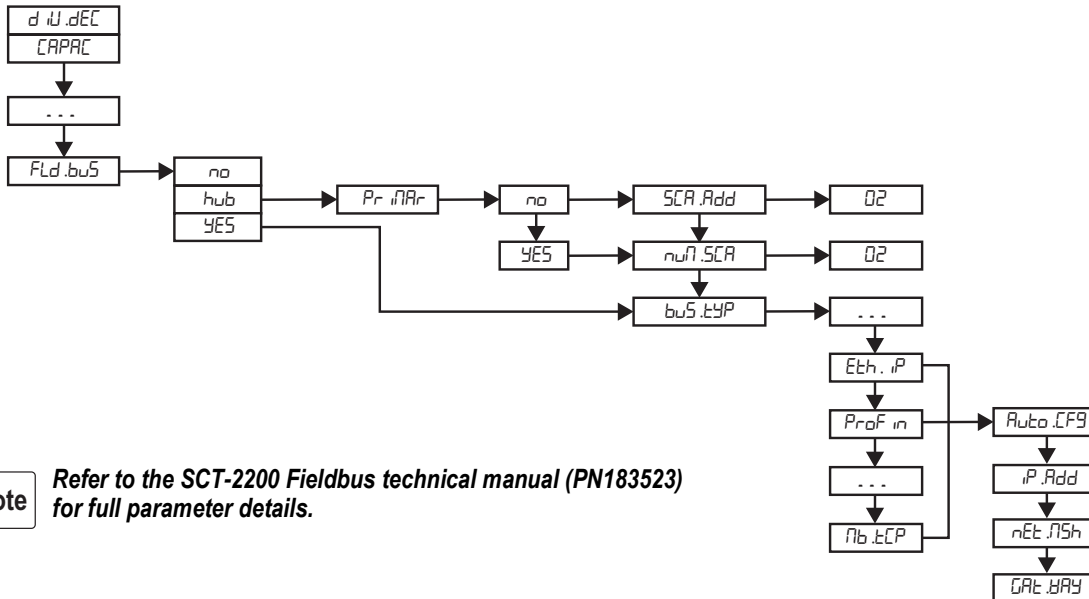

**Note** Refer to the *SCT-2200 Fieldbus technical manual (PN183523)* for full parameter details.

## Parameter Descriptions

- hub** Enables HUB mode
- Pr.inAr** In HUB mode, identifies the **primary scale** in the network to set the parameters
- Auto.CFG** Auto IP Configuration (no/yes)
- iP.Add** Sets the IP address
- nEt.MSh** Sets the net mask address
- GAt.WAY** Sets the Default Gateway

Note: if *Fld.buS* = YES or hub, RS-485 baud rate automatically set to 115,200 and scale address = 0 !

## Functioning Modes

### Single Scale Mode

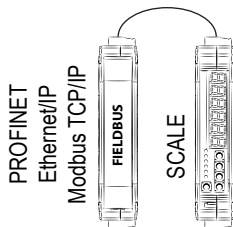

### Hub Mode

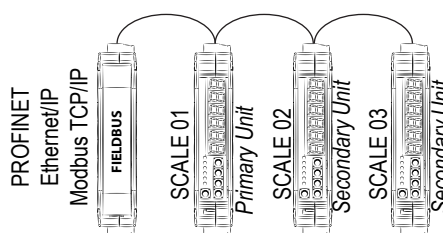

**Up to 16 SCT-2200 units can be connected.**

### Single Scale Mode Configuration

	Scale
HUB	no
Auto.CFG	00
iP.Add	000.000.000.000
nEt.MSh	000.000.000.000
GAt.WAY	000.000.000.000

### Hub Mode Configuration

Primary	Scale 1
HUB	YES
Pr.inAr	YES
Auto.CFG	00
iP.Add	000.000.000.000
nod.Ed	000.000.000.000
nuN.ScA	3

Secondary	Scale 02	Scale 03
HUB	YES	YES
Pr.inAr	no	no
ScA.Add	2	3

**In hub mode all of the parameters must be configured for the primary unit (scale 01). Secondary units need only a few parameters**

## Input Data (for data reading) - Single Scale Mode

Data	Byte		DESCRIPTION	EXAMPLE																														
Gross weight	1 <sup>(MSB)</sup>	40001	Bytes 1, 2, 3 and 4 contain the gross weight value	<table border="1"> <thead> <tr> <th colspan="5">Gross weight value examples</th> </tr> <tr> <th></th> <th>1000</th> <th>6000</th> <th>15000</th> <th>350000</th> </tr> </thead> <tbody> <tr> <td>1<sup>(MSB)</sup></td> <td>00 Hex</td> <td>00 Hex</td> <td>00 Hex</td> <td>00 Hex</td> </tr> <tr> <td>2</td> <td>00 Hex</td> <td>00 Hex</td> <td>00 Hex</td> <td>05 Hex</td> </tr> <tr> <td>3</td> <td>03 Hex</td> <td>17 Hex</td> <td>3A Hex</td> <td>57 Hex</td> </tr> <tr> <td>4<sup>(LSB)</sup></td> <td>E8 Hex</td> <td>70 Hex</td> <td>98 Hex</td> <td>30 Hex</td> </tr> </tbody> </table>	Gross weight value examples						1000	6000	15000	350000	1 <sup>(MSB)</sup>	00 Hex	00 Hex	00 Hex	00 Hex	2	00 Hex	00 Hex	00 Hex	05 Hex	3	03 Hex	17 Hex	3A Hex	57 Hex	4 <sup>(LSB)</sup>	E8 Hex	70 Hex	98 Hex	30 Hex
	Gross weight value examples																																	
		1000			6000	15000	350000																											
	1 <sup>(MSB)</sup>	00 Hex			00 Hex	00 Hex	00 Hex																											
2	00 Hex	00 Hex	00 Hex	05 Hex																														
3	03 Hex	17 Hex	3A Hex	57 Hex																														
4 <sup>(LSB)</sup>	E8 Hex	70 Hex	98 Hex	30 Hex																														
2																																		
3		40002																																
4 <sup>(LSB)</sup>																																		
Net weight	5 <sup>(MSB)</sup>	40003	Bytes 5, 6, 7 and 8 contain the net weight value	<table border="1"> <thead> <tr> <th colspan="5">Net weight value examples</th> </tr> <tr> <th></th> <th>1000</th> <th>6000</th> <th>15000</th> <th>350000</th> </tr> </thead> <tbody> <tr> <td>5<sup>(MSB)</sup></td> <td>00 Hex</td> <td>00 Hex</td> <td>00 Hex</td> <td>00 Hex</td> </tr> <tr> <td>6</td> <td>00 Hex</td> <td>00 Hex</td> <td>00 Hex</td> <td>05 Hex</td> </tr> <tr> <td>7</td> <td>03 Hex</td> <td>17 Hex</td> <td>3A Hex</td> <td>57 Hex</td> </tr> <tr> <td>8<sup>(LSB)</sup></td> <td>E8 Hex</td> <td>70 Hex</td> <td>98 Hex</td> <td>30 Hex</td> </tr> </tbody> </table>	Net weight value examples						1000	6000	15000	350000	5 <sup>(MSB)</sup>	00 Hex	00 Hex	00 Hex	00 Hex	6	00 Hex	00 Hex	00 Hex	05 Hex	7	03 Hex	17 Hex	3A Hex	57 Hex	8 <sup>(LSB)</sup>	E8 Hex	70 Hex	98 Hex	30 Hex
	Net weight value examples																																	
		1000			6000	15000	350000																											
	5 <sup>(MSB)</sup>	00 Hex			00 Hex	00 Hex	00 Hex																											
6	00 Hex	00 Hex	00 Hex	05 Hex																														
7	03 Hex	17 Hex	3A Hex	57 Hex																														
8 <sup>(LSB)</sup>	E8 Hex	70 Hex	98 Hex	30 Hex																														
6																																		
7		40004																																
8 <sup>(LSB)</sup>																																		
Input Status	9 <sup>(MSB)</sup>	40005	Bit 7 <sup>(LSB)</sup> No function Bit 6 No function Bit 5 No function Bit 4 No function Bit 3 No function Bit 2 No function Bit 1 Status of input n.2 (0 = OFF; 1 = ON) Bit 0 <sup>(LSB)</sup> Status of input n.1 (0 = OFF; 1 = ON)	<table border="1"> <thead> <tr> <th colspan="5">Input status</th> </tr> <tr> <th></th> <th>IN1 = OFF IN2 = OFF</th> <th>IN1 = ON IN2 = OFF</th> <th>IN1 = OFF IN2 = ON</th> <th>IN1 = ON IN2 = ON</th> </tr> </thead> <tbody> <tr> <td>9<sup>(MSB)</sup></td> <td>00 Hex</td> <td>01 Hex</td> <td>02 Hex</td> <td>03 Hex</td> </tr> <tr> <td>10<sup>(LSB)</sup></td> <td>-</td> <td>-</td> <td>-</td> <td>-</td> </tr> </tbody> </table>	Input status						IN1 = OFF IN2 = OFF	IN1 = ON IN2 = OFF	IN1 = OFF IN2 = ON	IN1 = ON IN2 = ON	9 <sup>(MSB)</sup>	00 Hex	01 Hex	02 Hex	03 Hex	10 <sup>(LSB)</sup>	-	-	-	-										
	Input status																																	
	IN1 = OFF IN2 = OFF	IN1 = ON IN2 = OFF	IN1 = OFF IN2 = ON	IN1 = ON IN2 = ON																														
9 <sup>(MSB)</sup>	00 Hex	01 Hex	02 Hex	03 Hex																														
10 <sup>(LSB)</sup>	-	-	-	-																														
	10 <sup>(LSB)</sup>		Bit 7 <sup>(MSB)</sup> 1 = Scale unloaded (gross weight = 0) Bit 6 Tare PT (1 = PT tare is active) Bit 5 Tare (1 = Tare is active) Bit 4 Overload condition (0 = No; 1 = Overload) Bit 3 Underload condition (0 = No; 1 = Underload) Bit 2 Weight Stability (0 = Unstable; 1 = Stable) Bit 1 Gross Weight Polarity (0 = "+"; 1 = "-") Bit 0 <sup>(LSB)</sup> Net Weight Polarity (0 = "+"; 1 = "-")	If BYTE 10 <sup>(LSB)</sup> = 45 HEX: <table border="1"> <thead> <tr> <th>Bit 7</th> <th>Bit 6</th> <th>Bit 5</th> <th>Bit 4</th> <th>Bit 3</th> <th>Bit 2</th> <th>Bit 1</th> <th>Bit 0</th> </tr> </thead> <tbody> <tr> <td>0</td> <td>1</td> <td>1</td> <td>0</td> <td>0</td> <td>1</td> <td>0</td> <td>1</td> </tr> </tbody> </table> Bit 0 = Net weight is negative Bit 1 = Gross weight is positive Bit 2 = Weight is stable Bit 5/6 = A Preset Tare is in memory	Bit 7	Bit 6	Bit 5	Bit 4	Bit 3	Bit 2	Bit 1	Bit 0	0	1	1	0	0	1	0	1														
Bit 7	Bit 6	Bit 5	Bit 4	Bit 3	Bit 2	Bit 1	Bit 0																											
0	1	1	0	0	1	0	1																											
-	11 <sup>(MSB)</sup>		Last received command																															
Command Status Register	12 <sup>(LSB)</sup>	40006	Bit 7 <sup>(MSB)</sup> Last command result Bit 6 Last command result Bit 5 Last command result Bit 4 Last command result Bit 3 Counting of processed commands Bit 2 Counting of processed commands Bit 1 Counting of processed commands Bit 0 <sup>(LSB)</sup> Counting of processed commands	Bit 0 to Bit 3 are used to count received commands, from 0 (0000) to 15 (1111). Bit 4 to Bit 7 are used to indicate the result of the last received command: <table border="1"> <thead> <tr> <th>Bit 7</th> <th>Bit 6</th> <th>Bit 5</th> <th>Bit 4</th> <th>Result</th> </tr> </thead> <tbody> <tr> <td>0</td> <td>0</td> <td>0</td> <td>0</td> <td>Command OK</td> </tr> <tr> <td>0</td> <td>0</td> <td>0</td> <td>1</td> <td>Incorrect command</td> </tr> <tr> <td>0</td> <td>0</td> <td>1</td> <td>0</td> <td>Incorrect command data</td> </tr> <tr> <td>0</td> <td>0</td> <td>1</td> <td>1</td> <td>Command not allowed</td> </tr> <tr> <td>0</td> <td>1</td> <td>0</td> <td>0</td> <td>Non-existent command</td> </tr> </tbody> </table>	Bit 7	Bit 6	Bit 5	Bit 4	Result	0	0	0	0	Command OK	0	0	0	1	Incorrect command	0	0	1	0	Incorrect command data	0	0	1	1	Command not allowed	0	1	0	0	Non-existent command
			Bit 7	Bit 6	Bit 5	Bit 4	Result																											
			0	0	0	0	Command OK																											
			0	0	0	1	Incorrect command																											
			0	0	1	0	Incorrect command data																											
0	0	1	1	Command not allowed																														
0	1	0	0	Non-existent command																														
Output status register	13 <sup>(MSB)</sup>	40007	No Function	<table border="1"> <thead> <tr> <th colspan="5">Output status</th> </tr> <tr> <th></th> <th>IN1 = OFF IN2 = OFF</th> <th>IN1 = ON IN2 = OFF</th> <th>IN1 = OFF IN2 = ON</th> <th>IN1 = ON IN2 = ON</th> </tr> </thead> <tbody> <tr> <td>13<sup>(MSB)</sup></td> <td>-</td> <td>-</td> <td>-</td> <td>-</td> </tr> <tr> <td>14<sup>(LSB)</sup></td> <td>00 Hex</td> <td>01 Hex</td> <td>02 Hex</td> <td>03 Hex</td> </tr> </tbody> </table>	Output status						IN1 = OFF IN2 = OFF	IN1 = ON IN2 = OFF	IN1 = OFF IN2 = ON	IN1 = ON IN2 = ON	13 <sup>(MSB)</sup>	-	-	-	-	14 <sup>(LSB)</sup>	00 Hex	01 Hex	02 Hex	03 Hex										
	Output status																																	
			IN1 = OFF IN2 = OFF		IN1 = ON IN2 = OFF	IN1 = OFF IN2 = ON	IN1 = ON IN2 = ON																											
13 <sup>(MSB)</sup>	-	-	-	-																														
14 <sup>(LSB)</sup>	00 Hex	01 Hex	02 Hex	03 Hex																														
	14 <sup>(LSB)</sup>		Bit 7 <sup>(MSB)</sup> No function ... Bit 2 No function Bit 1 Digital output 2 status (0 = OFF; 1 = ON) Bit 0 <sup>(LSB)</sup> Digital output 1 status (0 = OFF; 1 = ON)																															
	15																																	
	...	40008-40016																																
	32																																	

## Input Data (for data reading) - Hub Mode

DATA*	ΔΔ 1	ΔΔ 2	ΔΔ 3	ΔΔ 4	ΔΔ ...	ΔΔ 16	DESCRIPTION/EXAMPLE																																
In/Out status	1 [40001] [Modbus Address in Square Brackets]	9 [40005]	17 [40009]	25 [40013]	...	121 [40021]	<table border="1"> <thead> <tr> <th>Bit 7</th> <th>Bit 6</th> <th>Bit 5</th> <th>Bit 4</th> <th>Bit 3</th> <th>Bit 2</th> <th>Bit 1</th> <th>Bit 0</th> </tr> </thead> <tbody> <tr> <td>0</td> <td>0</td> <td>0</td> <td>0</td> <td>0</td> <td>0</td> <td>0</td> <td>0</td> </tr> </tbody> </table> <p>Bit 7 Scale present bit (Fixed value = 1)                      Bit 6/5 Progressive command loop counter;                      Values: 0 (00), 1 (01), 2 (10), 3 (11)                      Bit 4 Last command result (0 = OK; 1 = ERROR)                      Bit 3 Status of output n.2 (0 = OFF; 1 = ON)                      Bit 2 Status of output n.1 (0 = OFF; 1 = ON)                      Bit 1 Status of input n.2 (0 = OFF; 1 = ON)                      Bit 0 Status of input n.1 (0 = OFF; 1 = ON)</p> <p><b>EXAMPLE:</b>                      If Byte 1 = 13 Hex:</p> <table border="1"> <thead> <tr> <th>Bit 7</th> <th>Bit 6</th> <th>Bit 5</th> <th>Bit 4</th> <th>Bit 3</th> <th>Bit 2</th> <th>Bit 1</th> <th>Bit 0</th> </tr> </thead> <tbody> <tr> <td>0</td> <td>0</td> <td>0</td> <td>0</td> <td>1</td> <td>1</td> <td>0</td> <td>1</td> </tr> </tbody> </table> <p>Bit 0 = Input 1 is ON                      Bit 2 = Output 1 is ON                      Bit 3 = Output 2 is ON</p>	Bit 7	Bit 6	Bit 5	Bit 4	Bit 3	Bit 2	Bit 1	Bit 0	0	0	0	0	0	0	0	0	Bit 7	Bit 6	Bit 5	Bit 4	Bit 3	Bit 2	Bit 1	Bit 0	0	0	0	0	1	1	0	1
							Bit 7	Bit 6	Bit 5	Bit 4	Bit 3	Bit 2	Bit 1	Bit 0																									
0	0	0	0	0	0	0	0																																
Bit 7	Bit 6	Bit 5	Bit 4	Bit 3	Bit 2	Bit 1	Bit 0																																
0	0	0	0	1	1	0	1																																
Gross weight	2 <sub>(MSB)</sub> [40001]	10 <sub>(MSB)</sub> [40005]	18 <sub>(MSB)</sub> [40009]	26 <sub>(MSB)</sub> [40013]	...	122 <sub>(MSB)</sub> [40021]	For each scale there are three bytes containing the gross weight value <table border="1"> <thead> <tr> <th>ΔΔ 1</th> <th>3000 kg</th> </tr> </thead> <tbody> <tr> <td>2<sub>(MSB)</sub></td> <td>00 Hex</td> </tr> <tr> <td>3</td> <td>0B Hex</td> </tr> <tr> <td>4<sub>(LSB)</sub></td> <td>B8 Hex</td> </tr> </tbody> </table>	ΔΔ 1	3000 kg	2 <sub>(MSB)</sub>	00 Hex	3	0B Hex	4 <sub>(LSB)</sub>	B8 Hex																								
	ΔΔ 1	3000 kg																																					
	2 <sub>(MSB)</sub>	00 Hex																																					
3	0B Hex																																						
4 <sub>(LSB)</sub>	B8 Hex																																						
3 [40002]	11 [40006]	19 [40010]	27 [40014]	...	123 [40022]																																		
4 <sub>(LSB)</sub> [40002]	12 <sub>(LSB)</sub> [40006]	20 <sub>(LSB)</sub> [40010]	28 <sub>(LSB)</sub> [40014]	...	124 <sub>(LSB)</sub> [40022]																																		
Scale status	5 [40003]	13 [40007]	21 [40011]	29 [40015]	...	125 [40023]	<table border="1"> <thead> <tr> <th>Bit 7</th> <th>Bit 6</th> <th>Bit 5</th> <th>Bit 4</th> <th>Bit 3</th> <th>Bit 2</th> <th>Bit 1</th> <th>Bit 0</th> </tr> </thead> <tbody> <tr> <td>0</td> <td>0</td> <td>0</td> <td>0</td> <td>0</td> <td>0</td> <td>0</td> <td>0</td> </tr> </tbody> </table> <p>Bit 7 1 = Scale unloaded (gross weight = 0)                      Bit 6 Tare PT (1 = PT tare is active)                      Bit 5 Tare (1 = Tare is active)                      Bit 4 Overload condition (0 = No; 1 = Overload)                      Bit 3 Underload condition (0 = No; 1 = Underload)                      Bit 2 Weight Stability (0 = Unstable; 1 = Stable)                      Bit 1 Gross Weight Polarity (0 = "+"; 1 = "-")                      Bit 0 Net Weight Polarity (0 = "+"; 1 = "-")</p> <p><b>EXAMPLE:</b>                      If BYTE 5 = 45 HEX:</p> <table border="1"> <thead> <tr> <th>Bit 7</th> <th>Bit 6</th> <th>Bit 5</th> <th>Bit 4</th> <th>Bit 3</th> <th>Bit 2</th> <th>Bit 1</th> <th>Bit 0</th> </tr> </thead> <tbody> <tr> <td>0</td> <td>1</td> <td>1</td> <td>0</td> <td>0</td> <td>1</td> <td>0</td> <td>1</td> </tr> </tbody> </table> <p>Bit 0 = Net weight is negative                      Bit 1 = Gross weight is positive                      Bit 2 = Weight is stable                      Bit 5/6 = A Preset Tare is in memory</p>	Bit 7	Bit 6	Bit 5	Bit 4	Bit 3	Bit 2	Bit 1	Bit 0	0	0	0	0	0	0	0	0	Bit 7	Bit 6	Bit 5	Bit 4	Bit 3	Bit 2	Bit 1	Bit 0	0	1	1	0	0	1	0	1
							Bit 7	Bit 6	Bit 5	Bit 4	Bit 3	Bit 2	Bit 1	Bit 0																									
0	0	0	0	0	0	0	0																																
Bit 7	Bit 6	Bit 5	Bit 4	Bit 3	Bit 2	Bit 1	Bit 0																																
0	1	1	0	0	1	0	1																																
Net Weight	6 <sub>(MSB)</sub> [40003]	14 <sub>(MSB)</sub> [40007]	22 <sub>(MSB)</sub> [40011]	30 <sub>(MSB)</sub> [40015]	...	126 <sub>(MSB)</sub> [40023]	For each scale there are three bytes containing the net weight value <table border="1"> <thead> <tr> <th>ΔΔ 3</th> <th>1000 kg</th> </tr> </thead> <tbody> <tr> <td>22<sub>(MSB)</sub></td> <td>00 Hex</td> </tr> <tr> <td>23</td> <td>03 Hex</td> </tr> <tr> <td>24<sub>(LSB)</sub></td> <td>E8 Hex</td> </tr> </tbody> </table>	ΔΔ 3	1000 kg	22 <sub>(MSB)</sub>	00 Hex	23	03 Hex	24 <sub>(LSB)</sub>	E8 Hex																								
	ΔΔ 3	1000 kg																																					
	22 <sub>(MSB)</sub>	00 Hex																																					
23	03 Hex																																						
24 <sub>(LSB)</sub>	E8 Hex																																						
7 [40004]	15 [40008]	23 [40012]	31 [40016]	...	127 [40024]																																		
8 <sub>(LSB)</sub> [40004]	16 <sub>(LSB)</sub> [40008]	24 <sub>(LSB)</sub> [40012]	32 <sub>(LSB)</sub> [40016]	...	128 <sub>(LSB)</sub> [40024]																																		

## Output Data (for sending commands)

Command	Byte	Modbus Address	Description	Example																																																					
Transmitter ID	1	40001	Select the transmitter to receive the command:	To zero the weight of transmitter number 4:																																																					
			<table border="1"> <thead> <tr> <th>Transmitter</th> <th>Value</th> </tr> </thead> <tbody> <tr> <td>Transmitter 01</td> <td>01 Hex</td> </tr> <tr> <td>Transmitter 02</td> <td>02 Hex</td> </tr> <tr> <td>Transmitter 03</td> <td>03 Hex</td> </tr> <tr> <td>...</td> <td>... Hex</td> </tr> <tr> <td>Transmitter 16</td> <td>10 Hex</td> </tr> </tbody> </table> <p><b>NOTE: Transmitter ID must be set for each command.</b></p>	Transmitter	Value	Transmitter 01	01 Hex	Transmitter 02	02 Hex	Transmitter 03	03 Hex	...	... Hex	Transmitter 16	10 Hex	<table border="1"> <thead> <tr> <th>Byte</th> <th>Value</th> </tr> </thead> <tbody> <tr> <td>1</td> <td>04 Hex</td> </tr> <tr> <td>2</td> <td>01 Hex</td> </tr> </tbody> </table>	Byte	Value	1	04 Hex	2	01 Hex																																			
Transmitter	Value																																																								
Transmitter 01	01 Hex																																																								
Transmitter 02	02 Hex																																																								
Transmitter 03	03 Hex																																																								
...	... Hex																																																								
Transmitter 16	10 Hex																																																								
Byte	Value																																																								
1	04 Hex																																																								
2	01 Hex																																																								
Command	2	40001	Main available commands:	<b>EXAMPLE 1</b> For setting a preset tare of 1000 kg:																																																					
			<table border="1"> <thead> <tr> <th>Value</th> <th>Command</th> </tr> </thead> <tbody> <tr> <td>00 Hex</td> <td>No command</td> </tr> <tr> <td>01 Hex</td> <td>Scale zeroing</td> </tr> <tr> <td>02 Hex</td> <td>Tare</td> </tr> <tr> <td>03 Hex</td> <td>Preset Tare</td> </tr> <tr> <td>0A Hex</td> <td>Setpoint 1 setting</td> </tr> <tr> <td>0B Hex</td> <td>Setpoint 2 setting</td> </tr> <tr> <td>19 Hex</td> <td>Digital output setting</td> </tr> <tr> <td>22 Hex</td> <td>Reboot the weight transmitter</td> </tr> <tr> <td>23 Hex</td> <td>Read the calibration data</td> </tr> <tr> <td>24 Hex</td> <td>Write the calibration data</td> </tr> <tr> <td>25 Hex</td> <td>Calibration point acquisition</td> </tr> <tr> <td>26 Hex</td> <td>Abort the calibration procedure</td> </tr> <tr> <td>28 Hex</td> <td>Lock keyboard (parameter 1 = 0); Unlock keyboard (parameter 1 = 1)</td> </tr> </tbody> </table> <p><b>NOTE: To repeat the last command, set the command to "No command" value (0000 Hex) then repeat the command.</b></p> <p>Please refer to the SCT-2200 technical manual (PN 183522) for more information.</p>	Value	Command	00 Hex	No command	01 Hex	Scale zeroing	02 Hex	Tare	03 Hex	Preset Tare	0A Hex	Setpoint 1 setting	0B Hex	Setpoint 2 setting	19 Hex	Digital output setting	22 Hex	Reboot the weight transmitter	23 Hex	Read the calibration data	24 Hex	Write the calibration data	25 Hex	Calibration point acquisition	26 Hex	Abort the calibration procedure	28 Hex	Lock keyboard (parameter 1 = 0); Unlock keyboard (parameter 1 = 1)	<ol style="list-style-type: none"> <li>1. Set the transmitter address in byte 1</li> <li>2. Set the command in byte 2</li> <li>3. Set the tare value in parameter 1 (byte 3, 4, 5, 6)</li> </ol> <table border="1"> <thead> <tr> <th>Byte</th> <th>Value</th> </tr> </thead> <tbody> <tr> <td>1</td> <td>01 Hex</td> </tr> <tr> <td>2</td> <td>03 Hex</td> </tr> <tr> <td>3<sub>(MSB)</sub></td> <td>00 Hex</td> </tr> <tr> <td>4</td> <td>00 Hex</td> </tr> <tr> <td>5</td> <td>03 Hex</td> </tr> <tr> <td>6<sub>(LSB)</sub></td> <td>E8 Hex</td> </tr> </tbody> </table> <p><b>EXAMPLE 2</b> For setting the setpoint n. 1 of the scale n. 2 to 1000 kg:</p> <ol style="list-style-type: none"> <li>1. Set the transmitter address in byte 1</li> <li>2. Set the command in byte 2</li> <li>3. Set the setpoint value in parameter 1 (byte 3, 4, 5, 6)</li> </ol> <table border="1"> <thead> <tr> <th>Byte</th> <th>Value</th> </tr> </thead> <tbody> <tr> <td>1</td> <td>02 Hex</td> </tr> <tr> <td>2</td> <td>0A Hex</td> </tr> <tr> <td>3<sub>(MSB)</sub></td> <td>00 Hex</td> </tr> <tr> <td>4</td> <td>00 Hex</td> </tr> <tr> <td>5</td> <td>03 Hex</td> </tr> <tr> <td>6<sub>(LSB)</sub></td> <td>E8 Hex</td> </tr> </tbody> </table>	Byte	Value	1	01 Hex	2	03 Hex	3 <sub>(MSB)</sub>	00 Hex	4	00 Hex	5	03 Hex	6 <sub>(LSB)</sub>	E8 Hex	Byte	Value	1	02 Hex	2	0A Hex	3 <sub>(MSB)</sub>	00 Hex	4	00 Hex	5
Value	Command																																																								
00 Hex	No command																																																								
01 Hex	Scale zeroing																																																								
02 Hex	Tare																																																								
03 Hex	Preset Tare																																																								
0A Hex	Setpoint 1 setting																																																								
0B Hex	Setpoint 2 setting																																																								
19 Hex	Digital output setting																																																								
22 Hex	Reboot the weight transmitter																																																								
23 Hex	Read the calibration data																																																								
24 Hex	Write the calibration data																																																								
25 Hex	Calibration point acquisition																																																								
26 Hex	Abort the calibration procedure																																																								
28 Hex	Lock keyboard (parameter 1 = 0); Unlock keyboard (parameter 1 = 1)																																																								
Byte	Value																																																								
1	01 Hex																																																								
2	03 Hex																																																								
3 <sub>(MSB)</sub>	00 Hex																																																								
4	00 Hex																																																								
5	03 Hex																																																								
6 <sub>(LSB)</sub>	E8 Hex																																																								
Byte	Value																																																								
1	02 Hex																																																								
2	0A Hex																																																								
3 <sub>(MSB)</sub>	00 Hex																																																								
4	00 Hex																																																								
5	03 Hex																																																								
6 <sub>(LSB)</sub>	E8 Hex																																																								
Parameter 1	3 <sub>(MSB)</sub>	40002	First parameter of the command. Parameter is always expressed in absolute mode (no decimals, no sign).	<table border="1"> <thead> <tr> <th>Byte</th> <th>Value</th> </tr> </thead> <tbody> <tr> <td>1</td> <td>02 Hex</td> </tr> <tr> <td>2</td> <td>0A Hex</td> </tr> <tr> <td>3<sub>(MSB)</sub></td> <td>00 Hex</td> </tr> <tr> <td>4</td> <td>00 Hex</td> </tr> <tr> <td>5</td> <td>03 Hex</td> </tr> <tr> <td>6<sub>(LSB)</sub></td> <td>E8 Hex</td> </tr> </tbody> </table>	Byte	Value	1	02 Hex	2	0A Hex	3 <sub>(MSB)</sub>	00 Hex	4	00 Hex	5	03 Hex	6 <sub>(LSB)</sub>	E8 Hex																																							
	Byte				Value																																																				
1	02 Hex																																																								
2	0A Hex																																																								
3 <sub>(MSB)</sub>	00 Hex																																																								
4	00 Hex																																																								
5	03 Hex																																																								
6 <sub>(LSB)</sub>	E8 Hex																																																								
4	40003																																																								
Parameter 2	5	40004	Second parameter of the command. Parameter is always expressed in absolute mode (no decimals, no sign).																																																						
	6 <sub>(LSB)</sub>																																																								
Parameter 2	7 <sub>(MSB)</sub>	40004																																																							
	8																																																								
Parameter 2	9	40005																																																							
	10 <sub>(LSB)</sub>																																																								
-	11	40006-40016	-	-																																																					
	...																																																								
-	32	40006-40016	-	-																																																					
	...																																																								

## Calibration Procedure

DESCRIPTION	EXAMPLE																														
1. Send command 23 Hex to the transmitter to adjust calibration (transmitter ID has to be specified in byte 1)	<table border="1"> <thead> <tr> <th>Byte</th> <th>Value</th> <th>Description</th> </tr> </thead> <tbody> <tr> <td>1</td> <td>03 Hex</td> <td>Transmitter n. 3</td> </tr> <tr> <td>2</td> <td>23 Hex</td> <td>Command</td> </tr> </tbody> </table>	Byte	Value	Description	1	03 Hex	Transmitter n. 3	2	23 Hex	Command																					
Byte	Value	Description																													
1	03 Hex	Transmitter n. 3																													
2	23 Hex	Command																													
2. Select page 5001 for calibration using the CHANGE PAGE command (1D Hex)	<table border="1"> <thead> <tr> <th>Byte</th> <th>Value</th> <th>Description</th> </tr> </thead> <tbody> <tr> <td>1</td> <td>03 Hex</td> <td>Transmitter n. 3</td> </tr> <tr> <td>2</td> <td>1D Hex</td> <td>Change page</td> </tr> <tr> <td>3(MSB)</td> <td>00 Hex</td> <td rowspan="4">5001 (1389 Hex)</td> </tr> <tr> <td>4</td> <td>00 Hex</td> </tr> <tr> <td>5</td> <td>13 Hex</td> </tr> <tr> <td>6(LSB)</td> <td>89 Hex</td> </tr> </tbody> </table>	Byte	Value	Description	1	03 Hex	Transmitter n. 3	2	1D Hex	Change page	3(MSB)	00 Hex	5001 (1389 Hex)	4	00 Hex	5	13 Hex	6(LSB)	89 Hex												
Byte	Value	Description																													
1	03 Hex	Transmitter n. 3																													
2	1D Hex	Change page																													
3(MSB)	00 Hex	5001 (1389 Hex)																													
4	00 Hex																														
5	13 Hex																														
6(LSB)	89 Hex																														
3. Set the span adjustment weight on page 5001, from byte 19 to 22 (if different from the one used during the last calibration)	<table border="1"> <thead> <tr> <th colspan="5">Weight value examples</th> </tr> <tr> <th></th> <th>1000</th> <th>6000</th> <th>15000</th> <th>350000</th> </tr> </thead> <tbody> <tr> <td>19(MSB)</td> <td>00 Hex</td> <td>00 Hex</td> <td>00 Hex</td> <td>00 Hex</td> </tr> <tr> <td>20</td> <td>00 Hex</td> <td>00 Hex</td> <td>00 Hex</td> <td>05 Hex</td> </tr> <tr> <td>21</td> <td>03 Hex</td> <td>17 Hex</td> <td>3A Hex</td> <td>57 Hex</td> </tr> <tr> <td>22(LSB)</td> <td>E8 Hex</td> <td>70 Hex</td> <td>98 Hex</td> <td>30 Hex</td> </tr> </tbody> </table>	Weight value examples						1000	6000	15000	350000	19(MSB)	00 Hex	00 Hex	00 Hex	00 Hex	20	00 Hex	00 Hex	00 Hex	05 Hex	21	03 Hex	17 Hex	3A Hex	57 Hex	22(LSB)	E8 Hex	70 Hex	98 Hex	30 Hex
Weight value examples																															
	1000	6000	15000	350000																											
19(MSB)	00 Hex	00 Hex	00 Hex	00 Hex																											
20	00 Hex	00 Hex	00 Hex	05 Hex																											
21	03 Hex	17 Hex	3A Hex	57 Hex																											
22(LSB)	E8 Hex	70 Hex	98 Hex	30 Hex																											
4. Send "WRITE CALIBRATION" command (24 Hex), with: parameter 1 = 5001 (1389 Hex).	See example of point 2, but byte 2=24 Hex (Write Calibration).																														
5. Zero capture: unload the scale and write the "ACQUISITION POINT" command (25 Hex), with parameter 1 = 0.	<table border="1"> <thead> <tr> <th>Byte</th> <th>Value</th> <th>Description</th> </tr> </thead> <tbody> <tr> <td>1</td> <td>03 Hex</td> <td>Transmitter n. 3</td> </tr> <tr> <td>2</td> <td>25 Hex</td> <td>Acquisition point</td> </tr> <tr> <td>3(MSB)</td> <td>00 Hex</td> <td rowspan="4">Zero point acquisition</td> </tr> <tr> <td>4/5</td> <td>00 Hex</td> </tr> <tr> <td>6(LSB)</td> <td>00 Hex</td> </tr> </tbody> </table>	Byte	Value	Description	1	03 Hex	Transmitter n. 3	2	25 Hex	Acquisition point	3(MSB)	00 Hex	Zero point acquisition	4/5	00 Hex	6(LSB)	00 Hex														
Byte	Value	Description																													
1	03 Hex	Transmitter n. 3																													
2	25 Hex	Acquisition point																													
3(MSB)	00 Hex	Zero point acquisition																													
4/5	00 Hex																														
6(LSB)	00 Hex																														
6. Read the calibration status into page 5001 (byte 30, 31)  If acquisition is OK, then proceed with step 7; otherwise check the load cell mV/V (must be stable) and repeat step 5.	<table border="1"> <thead> <tr> <th>30(MSB)</th> <th>31(LSB)</th> <th></th> </tr> </thead> <tbody> <tr> <td>00 Hex</td> <td>00 Hex</td> <td>Calibration not started</td> </tr> <tr> <td>00 Hex</td> <td>01 Hex</td> <td>Acquisition underway</td> </tr> <tr> <td>00 Hex</td> <td>02 Hex</td> <td>Acquisition OK</td> </tr> <tr> <td>00 Hex</td> <td>03 Hex</td> <td>Acquisition error</td> </tr> <tr> <td>00 Hex</td> <td>04 Hex</td> <td>Calibration OK</td> </tr> <tr> <td>00 Hex</td> <td>05 Hex</td> <td>Calibration error</td> </tr> </tbody> </table>		30(MSB)	31(LSB)		00 Hex	00 Hex	Calibration not started	00 Hex	01 Hex	Acquisition underway	00 Hex	02 Hex	Acquisition OK	00 Hex	03 Hex	Acquisition error	00 Hex	04 Hex	Calibration OK	00 Hex	05 Hex	Calibration error								
30(MSB)	31(LSB)																														
00 Hex	00 Hex	Calibration not started																													
00 Hex	01 Hex	Acquisition underway																													
00 Hex	02 Hex	Acquisition OK																													
00 Hex	03 Hex	Acquisition error																													
00 Hex	04 Hex	Calibration OK																													
00 Hex	05 Hex	Calibration error																													
7. Span capture: load the scale with span weight and write the "ACQUISITION POINT" command (25 Hex), with parameter 1 = "1".  If acquisition is OK, proceed to step 8; if not check the load cell mV/V (must be stable and greater than zero point) and repeat step 7.	<table border="1"> <thead> <tr> <th>Byte</th> <th>Value</th> <th>Description</th> </tr> </thead> <tbody> <tr> <td>1</td> <td>03 Hex</td> <td>Transmitter n. 3</td> </tr> <tr> <td>2</td> <td>25 Hex</td> <td>Acquisition point</td> </tr> <tr> <td>3(MSB)</td> <td>00 Hex</td> <td rowspan="4">Span acquisition</td> </tr> <tr> <td>4/5</td> <td>00 Hex</td> </tr> <tr> <td>6(LSB)</td> <td>01 Hex</td> </tr> </tbody> </table>	Byte	Value	Description	1	03 Hex	Transmitter n. 3	2	25 Hex	Acquisition point	3(MSB)	00 Hex	Span acquisition	4/5	00 Hex	6(LSB)	01 Hex														
Byte	Value	Description																													
1	03 Hex	Transmitter n. 3																													
2	25 Hex	Acquisition point																													
3(MSB)	00 Hex	Span acquisition																													
4/5	00 Hex																														
6(LSB)	01 Hex																														
8. Store calibration using the "WRITE CALIBRATION" command (24 Hex), with parameter 1 = 0	<table border="1"> <thead> <tr> <th>Byte</th> <th>Value</th> <th>Description</th> </tr> </thead> <tbody> <tr> <td>1</td> <td>03 Hex</td> <td>Transmitter n. 3</td> </tr> <tr> <td>2</td> <td>24 Hex</td> <td>Write calibration</td> </tr> <tr> <td>3(MSB)</td> <td>00 Hex</td> <td rowspan="4">Store calibration</td> </tr> <tr> <td>4/5</td> <td>00 Hex</td> </tr> <tr> <td>6(LSB)</td> <td>00 Hex</td> </tr> </tbody> </table>		Byte	Value	Description	1	03 Hex	Transmitter n. 3	2	24 Hex	Write calibration	3(MSB)	00 Hex	Store calibration	4/5	00 Hex	6(LSB)	00 Hex													
Byte	Value	Description																													
1	03 Hex	Transmitter n. 3																													
2	24 Hex	Write calibration																													
3(MSB)	00 Hex	Store calibration																													
4/5	00 Hex																														
6(LSB)	00 Hex																														

## Messages

Message	Description
FbUS_Er	No connection received from module Hub after 30 seconds
F_r_HH.yy	Firmware version of the module hub
F_b_Conn	Start the Communication between hub module and scale
F_b_oH	Communication on fieldbus network configured and running
F_b_Err +code	Error state, see table error codes
F_bUS_in	Fieldbus initialization

## Hub Module Error Codes





Code	Description
1000	Fatal error in hub module
1001	Inconsistency between protocol type selected and the one managed by the Hub module, e.g. Hub type EtherCAT module with Devicenet protocol selected on SCT
1-18	Other fatal error in Hub module
000001 and the following	Unrecoverable error module Hub

## Network Error Codes

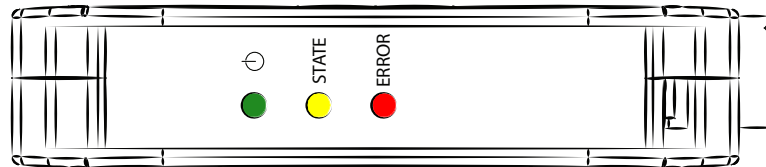
Code	Description
000140	General network error
000141	Connection closed
000142	Time-out connection
000143	Isolated network
000144	Duplicated node
000145	Network cable disconnected

## Annunciators



Annunciator	Description
 	Blinking green – initializing fieldbus module Solid green – fieldbus module is ready
 STATE	Indicates the RS-485 communication state between fieldbus module and weight transmitter: Solid yellow – initializing communication Rapid blinking yellow – fieldbus module is communicating correctly Slow blinking yellow – fieldbus module is attempting to communicate with the weight transmitter (no communication)
 ERROR	Off – communication is OK Solid or blinking red – no communication with the fieldbus master; check the cable connection, protocol and the PLC configuration



**Note** All LED annunciators turn on during the fieldbus module start-up to verify correct functioning.



© Rice Lake Weighing Systems Specifications subject to change without notice.  
Rice Lake Weighing Systems is an ISO 9001 registered company.

230 W. Coleman St. • Rice Lake, WI 54868 • USA  
U.S. 800-472-6703 • Canada/Mexico 800-321-6703 • International 715-234-9171 • Europe +31 (0)26 472 1319