

# SCT-4X Series

*Firmware version 01.21.01*

## Operation Manual



© Rice Lake Weighing Systems. All rights reserved.

Rice Lake Weighing Systems® is a registered trademark of  
Rice Lake Weighing Systems.

All other brand or product names within this publication are trademarks or  
registered trademarks of their respective companies.

All information contained within this publication is, to the best of our knowledge, complete and accurate at the  
time of publication. Rice Lake Weighing Systems reserves the right to make changes to the technology, features,  
specifications and design of the equipment without notice.

The most current version of this publication, software, firmware and all other product  
updates can be found on our website:

[www.ricelake.com](http://www.ricelake.com)

## Revision History

This section tracks and describes manual revisions for awareness of major updates.

Revision	Date	Description
A	January 4, 2024	Initial release

<b>Introduction</b>	<b>7</b>
<b>Transmitter Installation</b>	<b>8</b>
Installation Requirements	8
Electrical Precautions	9
Grounding the System	11
Technical Features	15
Load Cell Installation	16
<b>Wiring Diagrams</b>	<b>17</b>
SCT-4X-AN	17
SCT-4X-ETHIP, SCT-4X-PRONET, SCT-4X-MODTCP	18
<b>Display and Key Functions</b>	<b>19</b>
<b>Quick menu</b>	<b>19</b>
<b>Advanced Programming Menu</b>	<b>20</b>
Advanced Menu and Saving Changes	20
Menu Key Functions	20
Menu Block Diagram	21
<b>SCT-4X Operation Mode</b>	<b>23</b>
Mode 1 “DEP.CH”	23
Mode 2 “IND.CH”	23
<b>ADC Pre-calibration</b>	<b>23</b>
<b>Theoretical Calibration</b>	<b>24</b>
Dependent channels	24
Independent Channels	25
<b>Calibration with Sample Weights</b>	<b>26</b>
Dependent Channels (with Digital Equalization)	26
Independent Channels	28
<b>Equalization</b>	<b>30</b>
<b>Manual Calibration</b>	<b>31</b>

<b>Quick Zero Calibration (Pre-Tare Reset)</b>	<b>31</b>
<b>Filter and Stability</b>	<b>32</b>
Filter Adjustment	32
Anti-Peak Filter	33
Stability Detection Sensitivity	33
Stability Detection Time	34
Additional Filter for Stability Detection	34
<b>Gravity</b>	<b>35</b>
<b>Zero Functions and Parameters</b>	<b>36</b>
Auto-Zeroing on Start-Up	36
Maximum Percentage of Manual Zeroing	36
Zero Tracking	36
Zero Tracking Speed	37
Restoring Zero	37
Semi-Automatic Zeroing	37
<b>Tare Functions and Parameters</b>	<b>38</b>
Tare Mode	38
Semi-Automatic Tare	38
Predetermined Tare	38
Clearing a Tare	38
Restoring a Tare	38
<b>Alibi Memory</b>	<b>39</b>
Enabling the Alibi Memory	39
Saving a Weighing Operation in Alibi Memory	39
Reading Alibi Memory	40
Initializing Alibi Memory	40
<b>User Functions</b>	<b>41</b>
High Resolution	41
Peak Detection	41
Converting Units of Measure	41
Alibi Memory	41
No Function	41
<b>Input Configuration</b>	<b>42</b>
<b>Output Configuration</b>	<b>43</b>

<b>Analog Output Configuration</b>	<b>44</b>
<b>Serial Communication Configuration</b>	<b>46</b>
Selection of the PC serial port	46
<b>Printer Port (COM.PRN) Configuration</b>	<b>47</b>
Transmission mode	47
Baud Rate, Parity, Data Bits, Stop Bits	48
Printer power on mode	48
CTS signal	48
Print Language	49
Printing Reactivation	49
<b>PC Port (COM.PC) Configuration</b>	<b>50</b>
Transmission Mode	50
Baud Rate, Parity, Data Bits, Stop Bits	51
<b>USB Port Configuration</b>	<b>51</b>
<b>Communication Protocols</b>	<b>52</b>
Standard String	52
Extended String	52
Multi-Scale String	53
Serial Commands	54
Modbus Protocol	57
<b>Diagnostics</b>	<b>60</b>
<b>Unbalancing</b>	<b>61</b>
<b>Programming the Setpoints</b>	<b>62</b>
<b>Restoring Factory Settings</b>	<b>63</b>
<b>Alarms</b>	<b>64</b>

# Introduction

Thank you for purchasing this product.

This manual contains instructions for correct installation and commissioning of the SCT-4X four channel digital weight transmitter, including the following models:

- SCT-4X-AN
- SCT-4X-ETHIP
- SCT-4X-MODTCP
- SCT-4X-PRONET

This manual contains the instructions for a correct installation and commissioning of the SCT-4X four channel digital weight transmitter.

Also, this manual provides information on the correct operation and maintenance of the weigh transmitter. It is essential to pay the close attention to operation procedures.

It is recommended that you carefully follow the instructions for programming the weight transmitter; performing actions not indicated in this manual could compromise the functionality of the scale.



Manuals are available from Rice Lake Weighing Systems at [www.ricelake.com/manuals](http://www.ricelake.com/manuals)

Warranty information is available at [www.ricelake.com/warranties](http://www.ricelake.com/warranties)

Any problem with the product must be reported to the manufacturer or to the retailer where it was purchased.

Always TURN OFF THE POWER SUPPLY prior to installation or repair action.

## Installation Requirements

Observe the following conditions for correct installation of the transmitter and of the load receiver:

- Flat, level support surface.
- Stability and absence of vibrations.
- Absence of aggressive dusts and vapours.
- Absence of draughts.
- Make sure that the platform is levelled or that the load cells are evenly supported.
- Moderate temperature and humidity 59°F 86°F (15°C - 30°C and 40% - 70%).
- Do not install in an environment where there is a risk of explosion.
- All transmitter connections must be made in accordance with applicable regulations in the area and environment of installation. Observe the electrical precautions listed in the section “**Electrical precautions**”.
- Ensure that it is correctly earthed, see the relevant section “**Grounding the system**”.
- Do not perform welding when the load cells have already been installed.
- If necessary, use watertight sheaths and fittings to protect the load cell cables.
- Any junction boxes must be watertight.
- Anything not expressly described in this manual constitutes improper use of the equipment.



## Electrical Precautions

- Use a regulated mains supply within  $\pm 10\%$  of the rated voltage.
- The electrical protections (*fuses, etc.*) are the responsibility of the installer.
- Observe the recommended minimum distances between cables of different categories (**see table on page 10**).
- The following cables must comply with the maximum permissible lengths (**see table on page 10**), they must be shielded and must be inserted alone in metal conduits or pipes:
  - the load cell extension cables;
  - the signal amplifier cables;
  - the cables for connecting the serial ports;
  - the analog output cables.
- The cell or amplifier cables must have an independent input in the electrical panel. They must be connected (if possible) directly to the terminal block of the transmitter without passing through the conduit with other cables.
- Fit "RC" filters:
  - on the contactor coils;
  - on the solenoid valve coils;
  - on all devices that produce electrical interference.
- If condensation can occur inside the weight transmitter, it is advisable to keep the equipment powered at all times.
- Connections to load cells and any external device must be as short as possible.
- The cable ends (connectors, leads, terminals, etc.) must be installed correctly; the cable shielding must be kept intact until close to the connection point.
- If the transmitter is placed inside an electrical panel, a shielded cable must also be used for the power supply.

**RECOMMENDED DISTANCES AND CABLE CLASSIFICATION**

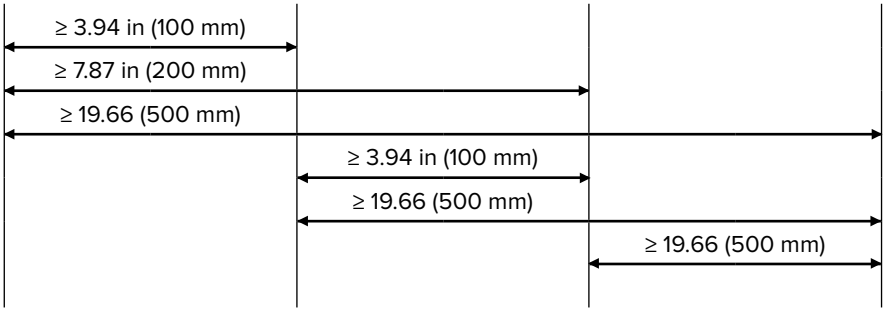
	Category I	Category II	Category III	Category IV
<b>Distance</b>				
<b>Classification</b>	Fieldbus, LAN network (PROFIBUS or Ethernet).  Shielded data cables (RS232...).  Shielded cables for analog digital signals < 25 V (sensors, load cells...).  Low voltage power supply cables (< 60 V).  Coaxial cables.	DC supply cables with voltage > 60 V and < 400 V.  AC supply cables with voltage > 25 V and < 400 V.	Power supply cables with voltage > 400 V.  Telephone cables.	Any cable subject to lightning danger.

**MAXIMUM ALLOWED LENGTHS**

Load cell	RS232	RS485	Analog output
164 ft (50 m) with 6 x 24 AWG (0.25 mm <sup>2</sup> ) cable;  328 ft (100 m) with 6 x 22 AWG (0.5 mm <sup>2</sup> ) cable.	49 ft (15 m) with baud rate up to 19200.	3937 ft (1200 m) with shielded 2 x 24 AWG twisted pair with outer braid + aluminium strip.	<b>CURRENT:</b> <ul style="list-style-type: none"> <li>• 328 ft (100 m) with 2 x 24 AWG (0.25 mm<sup>2</sup>) cable;</li> <li>• 492 ft (150 m) with 2 x 22 AWG (0.5 mm<sup>2</sup>) cable;</li> <li>• 984 ft (300 m) with 2 x 17 AWG (1 mm<sup>2</sup>) cable.</li> </ul> <b>VOLTAGE:</b> <ul style="list-style-type: none"> <li>• 164 ft (50 m) with 2 x 24 AWG (0.25 mm<sup>2</sup>) cable;</li> <li>• 246 ft (75 m) with 2 x 22 AWG (0.5 mm<sup>2</sup>) cable;</li> <li>• 150 meters with 2 x 17 AWG (1 mm<sup>2</sup>) cable.</li> </ul>

# Grounding the System

For correct earthing and optimal system operation, the transmitter, load cells, junction box, if any, and weighing structure must be earthed.

## TRANSMITTER

The earth connection must be made via the appropriate terminal. The cable cross-section must be less than 14 AWG (2.5 mm<sup>2</sup>). The transmitter must be powered by a dedicated power supply with ground. Do not connect EARTH and GND terminals together!

SCT-4X Correct earth connection

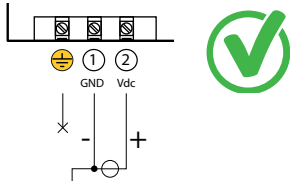

SCT-4X Incorrect earth connection

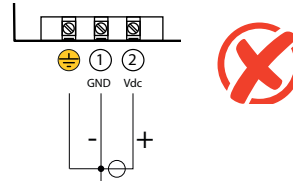

## LOAD CELLS AND JUNCTION BOX

The connection must be made by connecting the earth cables to the earth bar (cables that must have a cross-section of at least 6 AWG (16 mm<sup>2</sup>); finally, connect the earth bar to the earth post with a cable having a cross-section of at least 1-1/0 AWG (50 mm<sup>2</sup>).

### EXAMPLES:

- If the load cells are connected to the transmitter through a junction box, the cable shield from the transmitter and the cell cable shields must be connected to the earth socket of the junction box (refer to the junction box manual) and the junction box must be earthed using a copper cable with a cross-section of not less than 6 AWG (16 mm<sup>2</sup>).
- If the load cells are connected directly to the transmitter (without using the junction box), the cell cable shields must be connected to the earthing point (or earth bar).
- If the weighing system involves large and/or outdoor structures (weighbridges, silos, etc.) and the distance between the junction box and the weight transmitter is greater than 33 ft (10 m), connect the cell cable shields to the earth socket in the junction box.

## WEIGHING STRUCTURE

Earth the weighing structure and/or any unconnected structures (e.g. silos that release material onto the weighing structure) using cables with a cross-section of not less than 6 AWG (16 mm<sup>2</sup>).

Also connect the upper part with the lower part of each cell by means of a copper braid with a cross-section not less than 6 AWG (16 mm<sup>2</sup>) (refer to the **earthing examples on page 12 and page 13**).

## SERIAL CABLES AND CONNECTED INSTRUMENTS

Connect the serial cable shield to the earthing point (or earth bar) inside the panel. To avoid any undesired effects, the earth reference of the connection cable, power supply and transmitter must be at the same potential.

**GENERAL NOTES:**

- All earth cables must be of suitable length, so as to obtain an overall resistance of the earthing system of less than 1  $\Omega$ .
- If the weighing system involves large and/or outdoor structures (weighbridges, silos, etc.):
  - the earth connection must be made by connecting the earth cables to an earth bar and the earth bar to the earth post with a cable having a cross-section of not less than 1-1/0 AWG (50 mm<sup>2</sup>);
  - the earth post must be placed at a distance of at least 33 ft (10 m) from the structure.
- If the load receiver is more than 33 ft (10 m) from the transmitter, we recommend using the SENSE line and load cells equipped with a (SENSE) compensation circuit.

**EXAMPLE OF EARTHING OF A WEIGHBRIDGE**

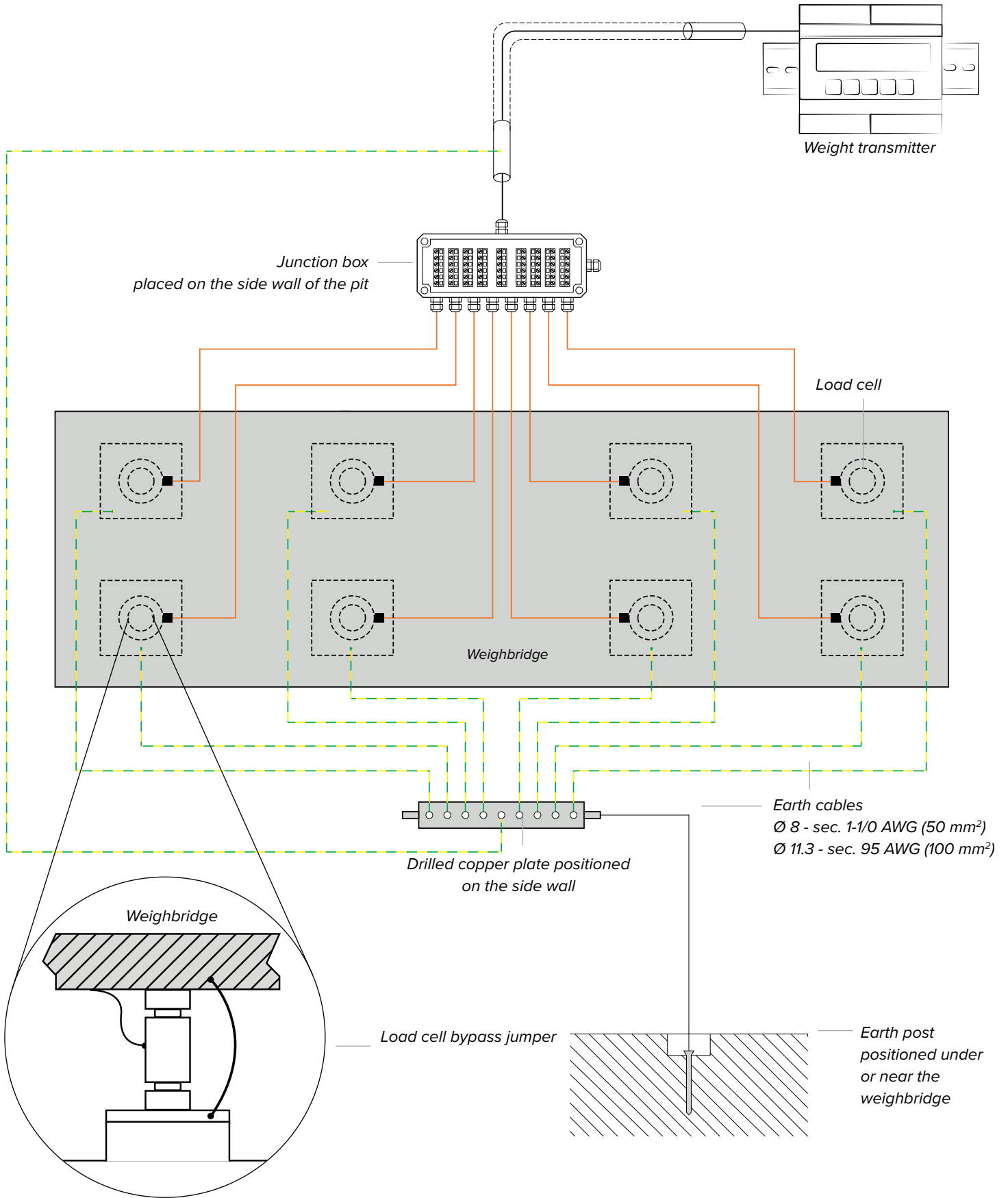

EXAMPLE OF EARTHING OF A SILO

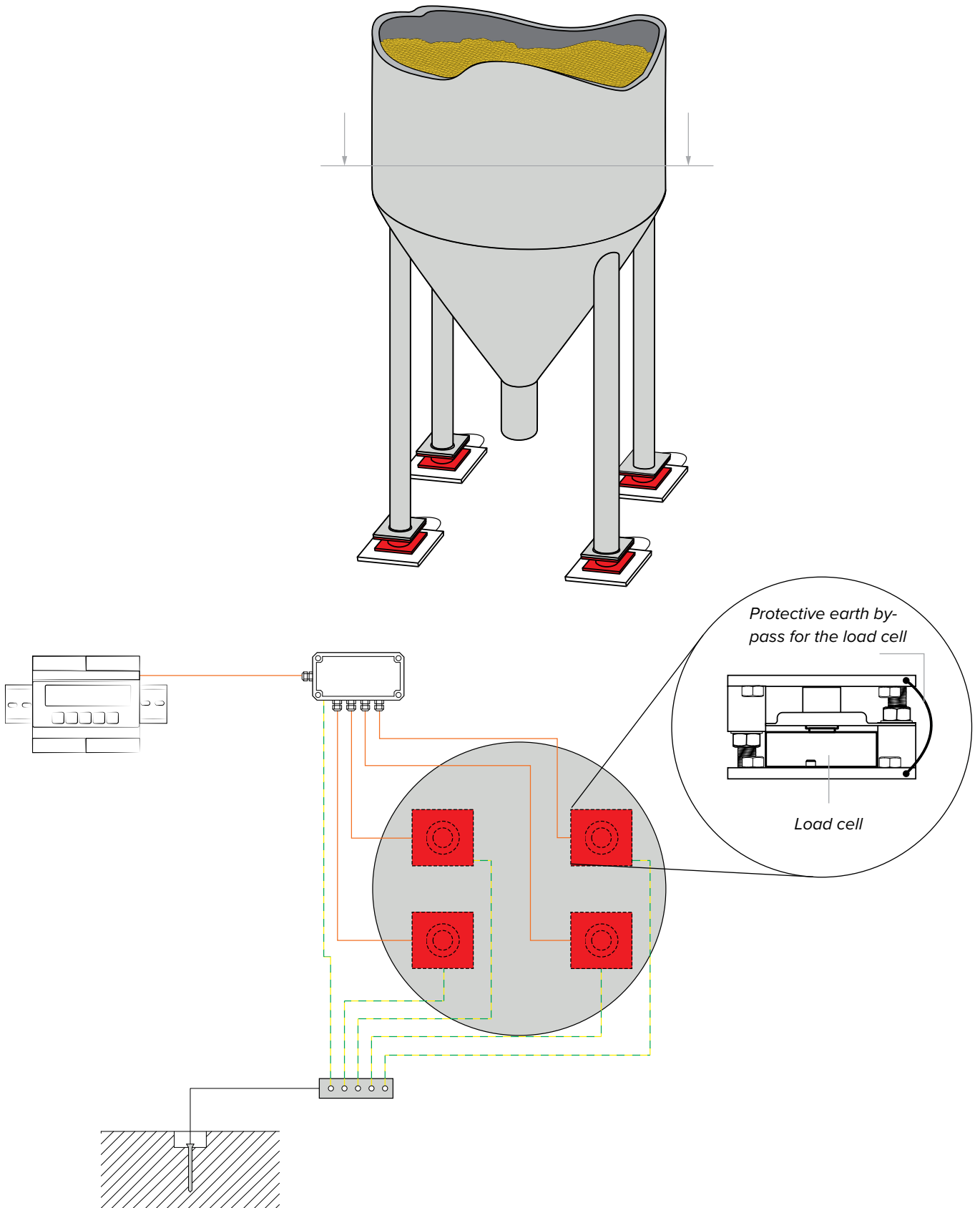

## Technical Features

<b>POWER SUPPLY</b>	12 - 24 VDC LPS or with class 2 power supply.
<b>MAXIMUM ABSORPTION</b> (without load cells)	<ul style="list-style-type: none"> <li>SCT-4X-AN: 4.5 W</li> <li>SCT-4X-ETHIP, SCT-4X-PRONET, SCT-4X-MODTCP: 7.5 W</li> </ul>
<b>OPERATING TEMPERATURE</b>	From 14°F to 104°F (-10°C to +40°C)
<b>DISPLAY DIVISIONS</b>	10000e, 2 x 3000e for legal weighing, expandable up to 800,000 for internal use (with a minimum cell signal of 1.6 mV/V)
<b>CONVERSION SPEED</b>	Up to 2600 conversions / sec with single channel Up to 100 conversions / sec with 4 channels
<b>MINIMUM VOLTAGE PER DIVISION</b>	0.3 $\mu$ V ( <i>restricted transmitter</i> ); 0.03 $\mu$ V ( <i>non-restricted transmitter</i> ).
<b>COUNTING RESOLUTION</b>	1,500,000 points (with input signal 3 mV/V)
<b>DISPLAY</b>	6 digits, 0.56 in (14.2 mm) height
<b>SIGNALS</b>	9 status indicator LED lights
<b>KEYPAD</b>	Mechanical with 5 keys.
<b>TARE FUNCTION</b>	Subtraction possible over the entire range
<b>LOAD CELL POWER SUPPLY</b>	5 VDC, 230 mA
<b>LOAD CELL CONNECTION</b>	6 wires (CELL1) with sense, 4 wires (CELLS 2, 3, 4)
<b>CONNECTABLE CELLS</b>	Up to 16 350 $\Omega$ cells
<b>CASE</b>	Made of plastic (self-extinguishing PPO), suitable for DIN rail mounting (EN 60715 - DIN43880) or wall mounting
<b>SERIAL OUTPUTS</b>	<ul style="list-style-type: none"> <li>1 half duplex RS485 bidirectional port on terminal (SCT-4X-AN).</li> <li>1 RS232 bidirectional port on terminal</li> <li>2 ETHERNET ports (versions SCT-4X-ETHIP*, SCT-4X-MODTCP*, SCT-4X-PRONET*)</li> <li>1 USB port (micro USB type B) on front panel → Virtual COM (Device)</li> </ul> <p><i>* Fieldbus models are not equipped with port 232</i></p>
<b>OUTPUTS / INPUTS</b>	<ul style="list-style-type: none"> <li>2 photomofet NO or NC outputs: max 60 VDC 0.5 A max / 48 VAC 0.5A;</li> <li>2 configurable inputs (bidirectional optocouplers): 12 - 48 VDC; Input reading and output update time: 1 millisecond</li> <li>16-bit analog output (SCT-4X-AN version)</li> <li>Current: 0 - 20 mA / 4 - 20 mA. Voltage: 0 - 5 VDC, 0 - 10 VDC. The maximum applicable resistance on the current output is 300 <math>\Omega</math> while the minimum applicable resistance on the voltage output is 1 k<math>\Omega</math>.</li> </ul>
<b>LOAD CELL SENSITIVITY</b>	Maximum sensitivity of the connectible load cells: 6 mV/V
<b>FIELDBUS UPDATE RATES</b>	Up to 120 Hz

# Load Cell Installation

After carrying out the instructions for the platform or load receiver, the shielded cable from the cell(s) must be properly connected to the terminal block(s) of the transmitter (from CELL1 to CELL4; see page 17).

The transmitter has one channel (CELL1) for 6-wire connection to load cells (using the REFERENCE), while for the remaining channels (CELL2, CELL3, CELL4) only 4-wire connection is allowed.

The REFERENCE allows you to compensate for any voltage drop on the section of cable connecting the transmitter to the load receiver. It is especially useful when the distance between the transmitter and the load receiver is more than 33 ft (10 meters), or in high-resolution applications.

**i** The SCT-4X has a DIP switch (EXC-SEN) located under the cover for Cell 1 and 2 connections. Set the DIP switch to correspond with the type of load cells connected to the transmitter:

- ON for a 4-wire connection
- OFF for a 6-wire connection

## 4-Wire Connection

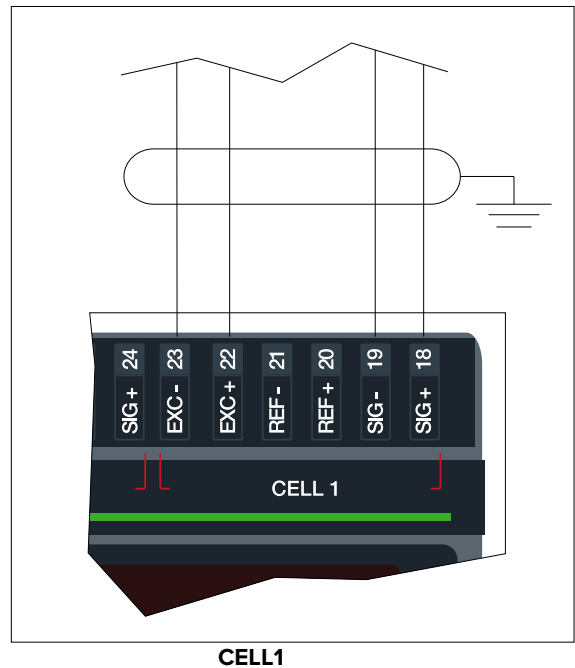
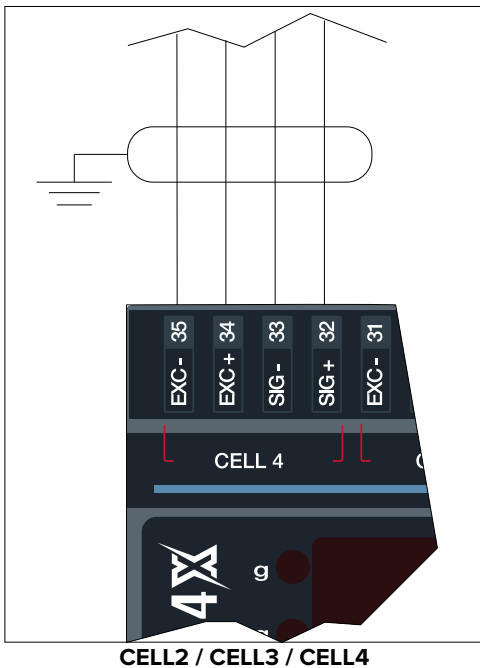

## 6-Wire Connection

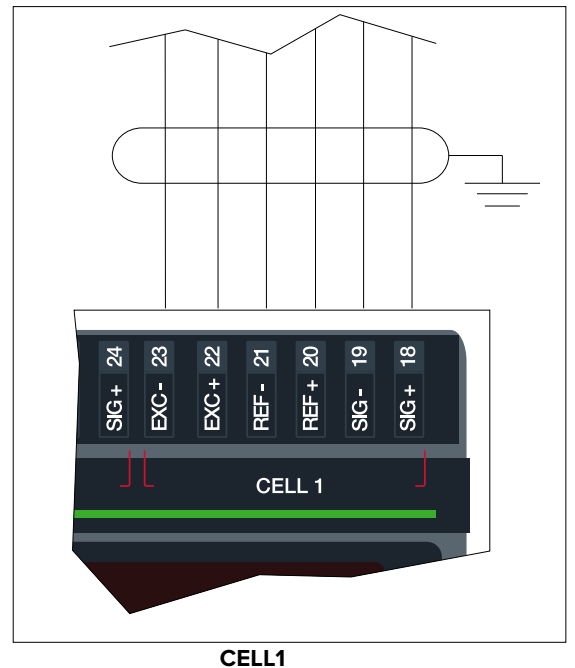
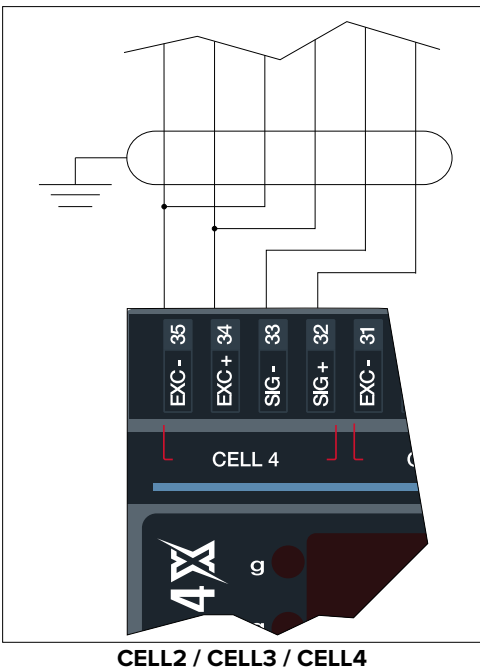



## SCT-4X-AN

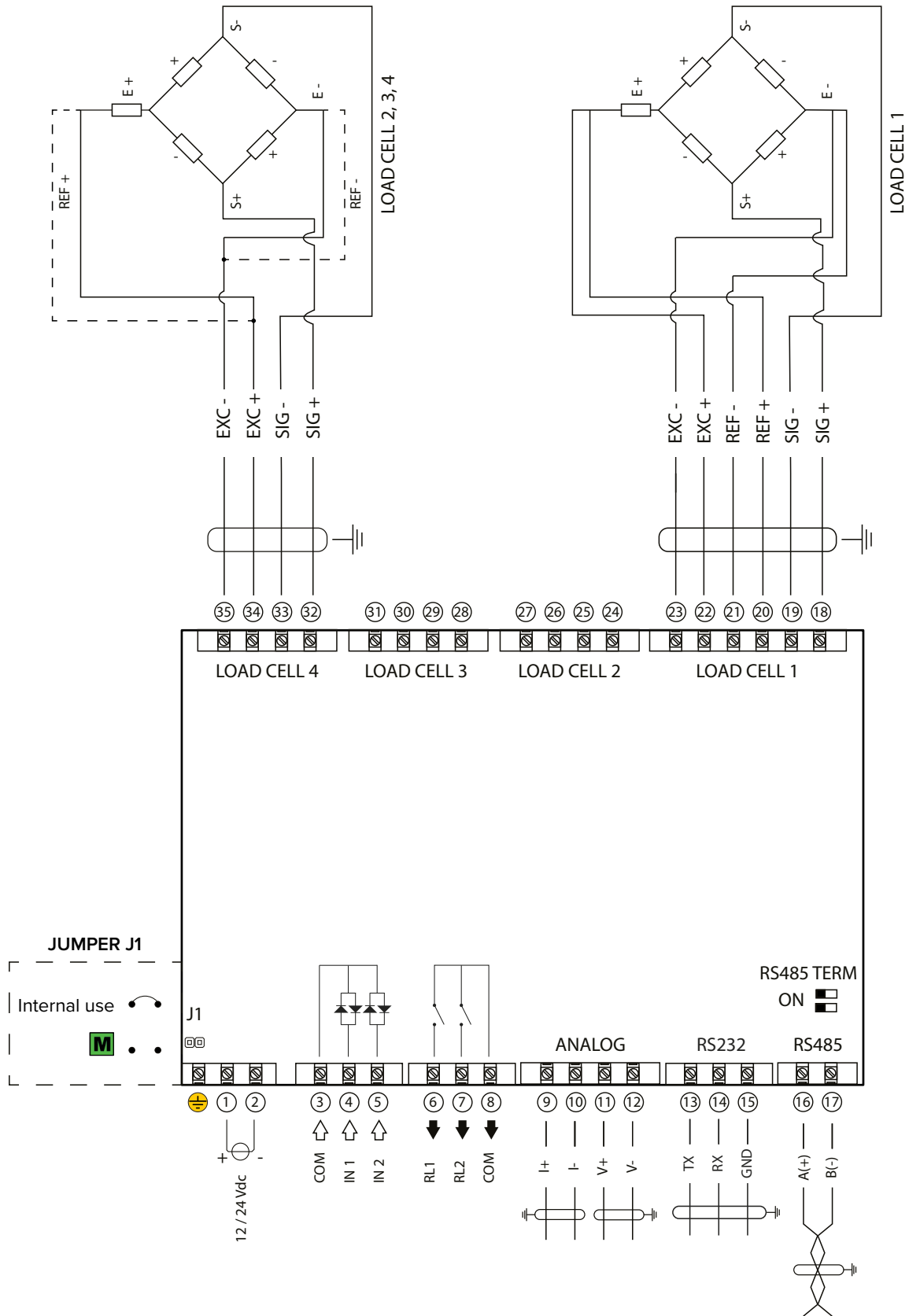

# SCT-4X-ETHIP, SCT-4X-PRONET, SCT-4X-MODTCP

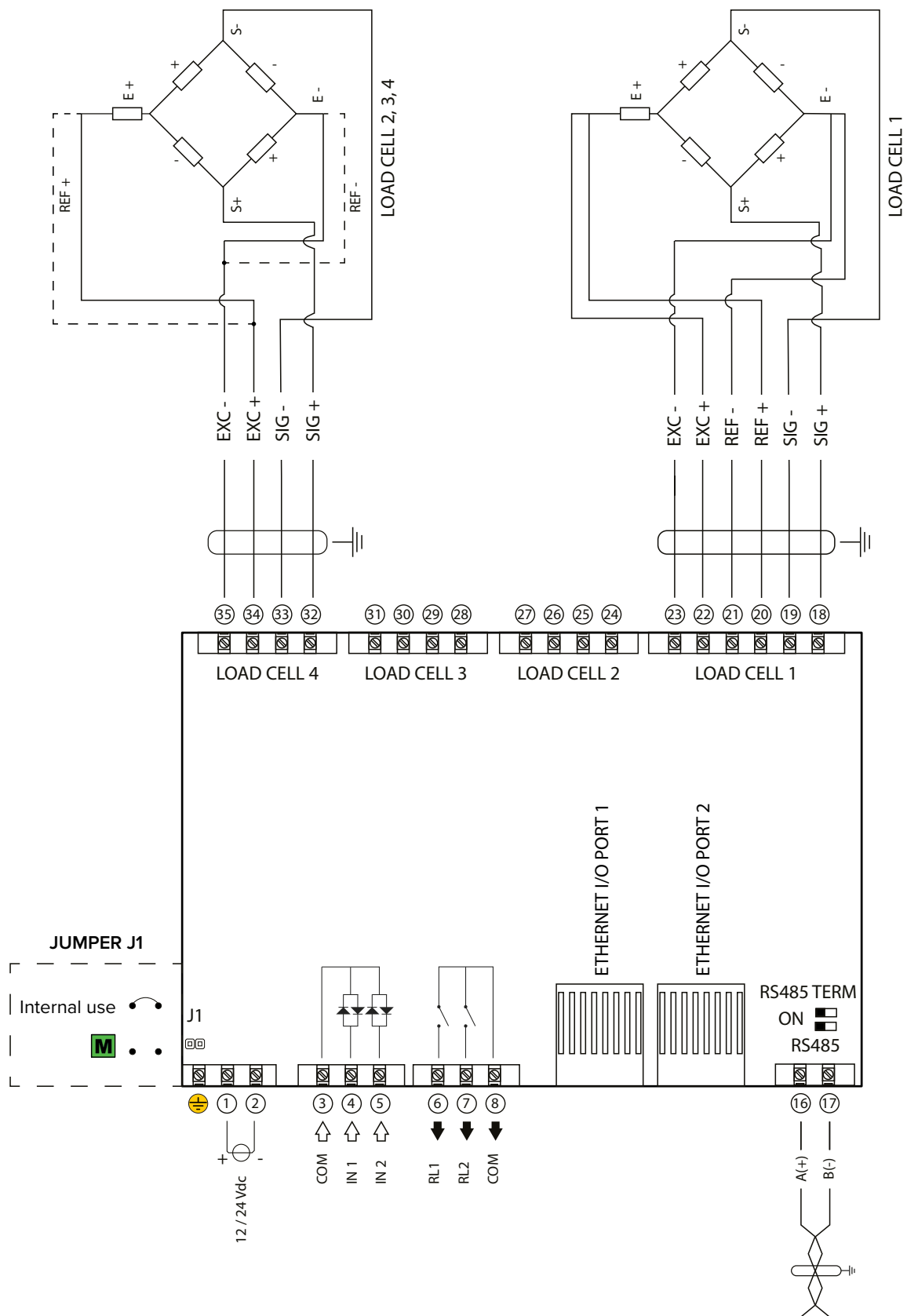



Symbol	Description
▽	Semi-automatic zeroing. Decreases the selected digit.
△	Semi-automatic tare. Increases the selected digit.
▷	Activates the function. Selects the digit to be changed. Prolonged pressure allows you to select the active scale (only in MODE 2 "IND.CH").
↵	Confirms a value. Prints / Transmits data.
Ⓢ	Reboots the transmitter.

Symbol	Description
>0<	Gross weight on zero.
~	Unstable weight.
NET	A tare is active.
F	A special function is active.
W1 SP1	Output 1 is active.
W2 SP2	Output 2 is active.

## Quick menu

The transmitter is equipped with a quick menu, through which you can program the main parameters of the scale. To enter the quick menu, follow the procedure below:

1. Reboot the transmitter.
2. Press the ▷ key when the display shows **BBBBBB**.

# Advanced Programming Menu

The advanced menu contains all the transmitter configuration parameters for the most advanced adjustments.

## Advanced Menu and Saving Changes

1. Reboot the transmitter.
2. Press the ▲ key when the display shows 888888.



### HOW TO EXIT THE SETUP AND SAVE CHANGES

1. Press C several times, until the display shows "SAVE?".
2. Press ← to save or C to exit without saving.

## Menu Key Functions

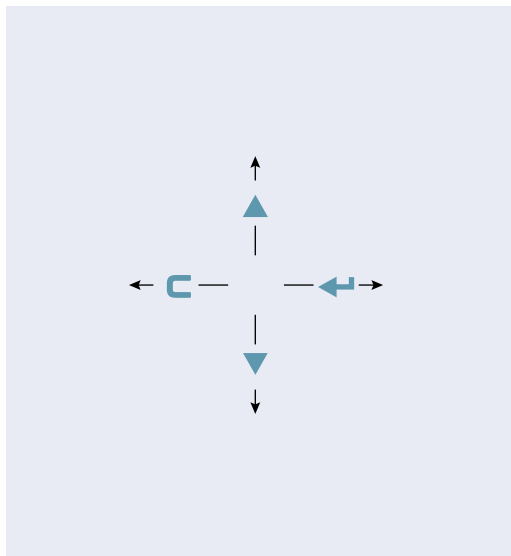

- ▲ Previous parameter.
- ▼ Next parameter.
- ←→ Access the parameter / confirm setting.
- C Exit a parameter (without saving).

### FUNCTION OF THE KEYS WHEN ENTERING NUMBERS

- ▲ Increases the selected digit.
- ▼ Decreases the selected digit.
- ▶ Selects the next digit.
- ←→ Confirms the value.
- C Resets the value.  
If pressed again, exits entering.



In the menu description on the following pages the ▼ symbol indicates repeated pressing of the ▼ key until the parameter indicated is reached.



Complete menu  
on pages 21 - 22

#### MENU ACCESS:

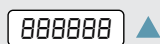

Press the ▲ key during the start-up procedure.

#### SAVING THE PARAMETERS:

Press the C key several times, until the display shows SAVE?. Press the ←→ key to confirm.

# Menu Block Diagram

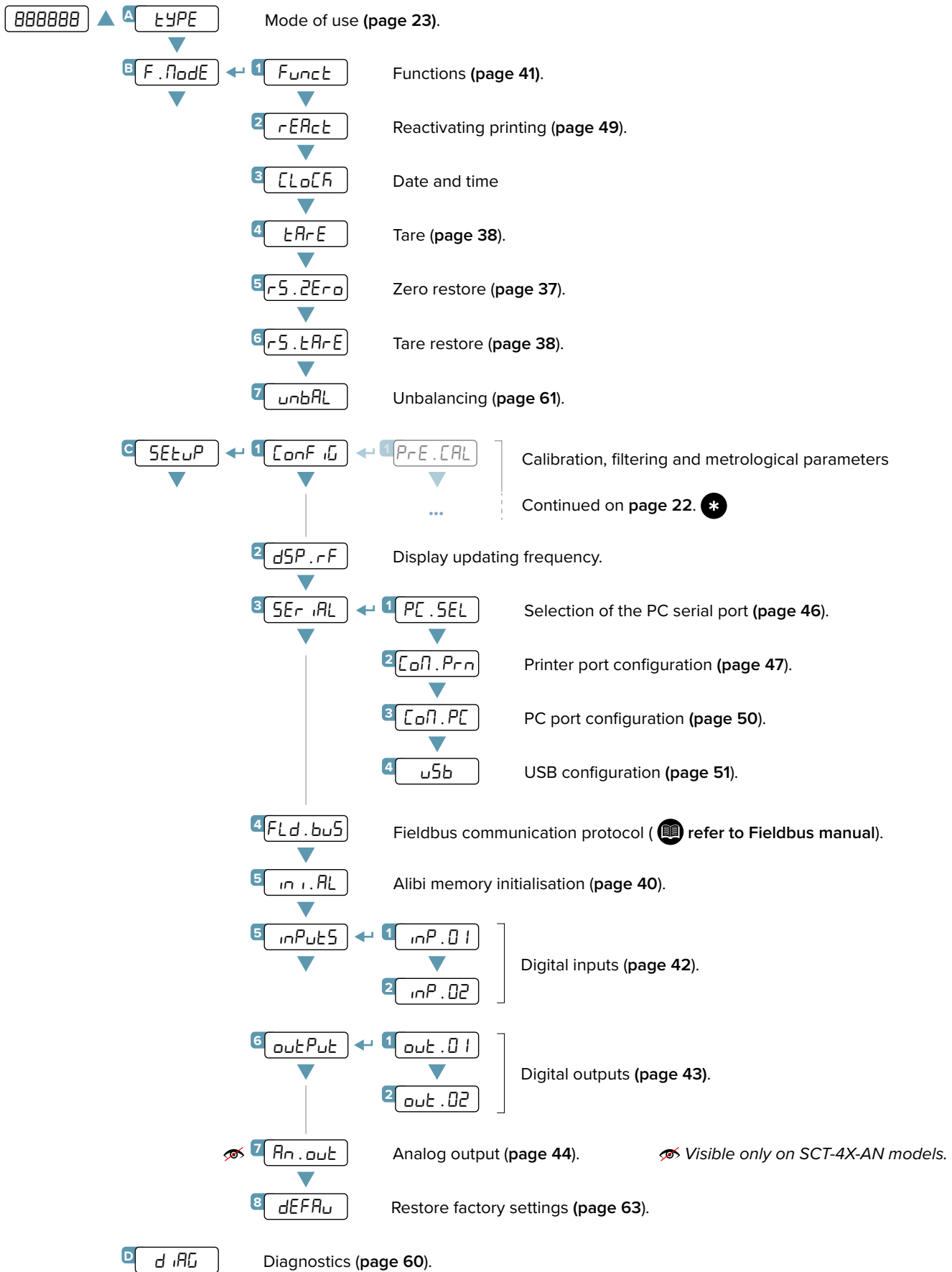

## LEGEND:

- Indicates repeated pressing of the **▼** key.
- Parameter visible only under certain conditions.
- Parameter or menu subject to approval.
- Default value of the parameter.

\* Full CONF ID ← SETUP menu is displayed.

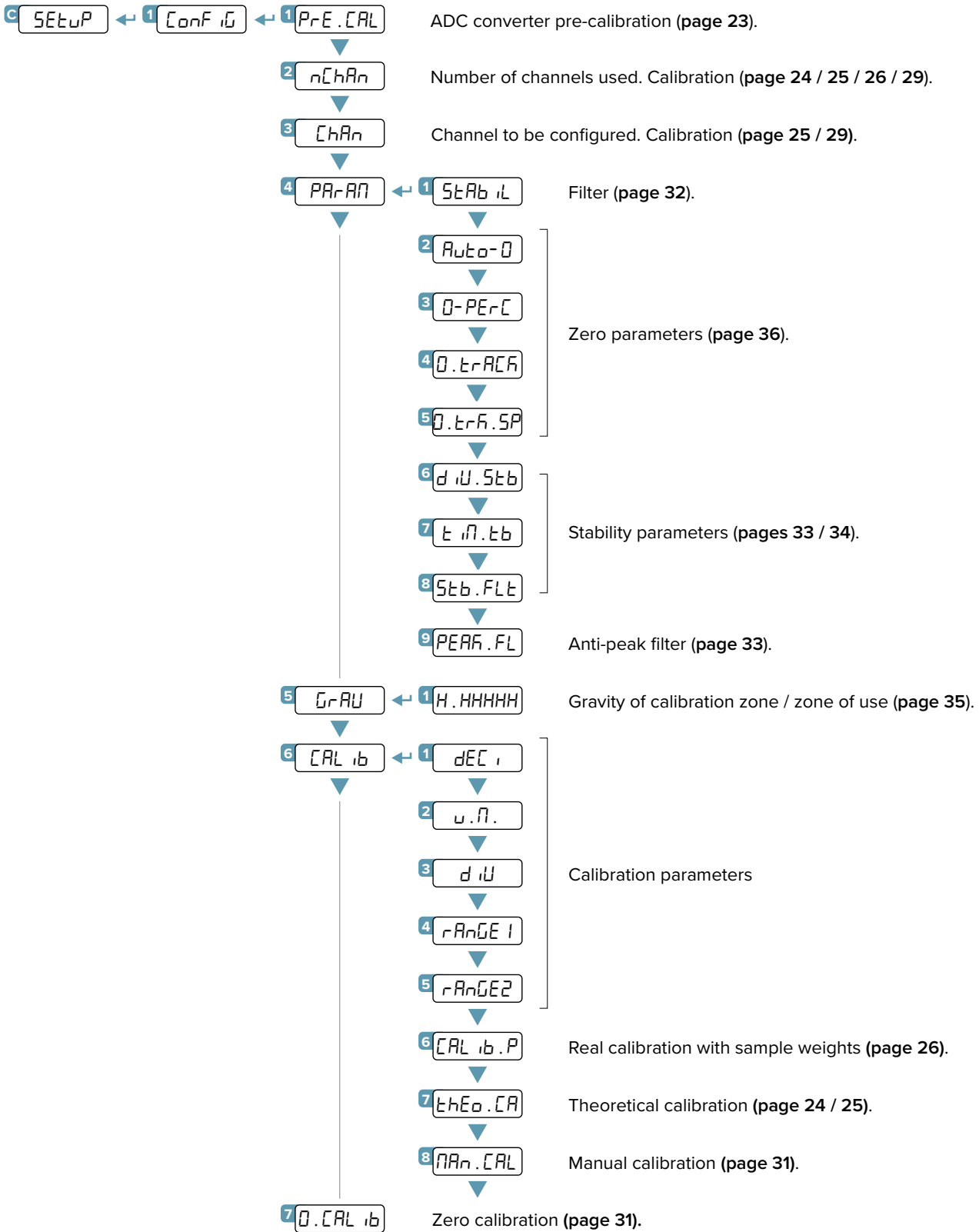

Complete menu on pages 21 - 22

**MENU ACCESS:**

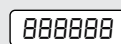

▲ Press the ▲ key during the start-up procedure.

**SAVING THE PARAMETERS:**

Press the C key several times, until the display shows SAUEP. Press the ← key to confirm.

# SCT-4X Operation Mode

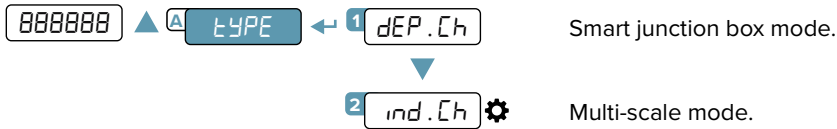

## Mode 1 “DEP.CH”

Allows you to connect the load cells (from 2 to 4) directly and to equalise them.

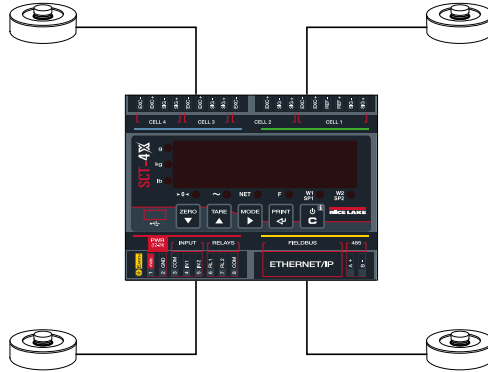

## Mode 2 “IND.CH”

Allows you to manage up to 4 independent scales.

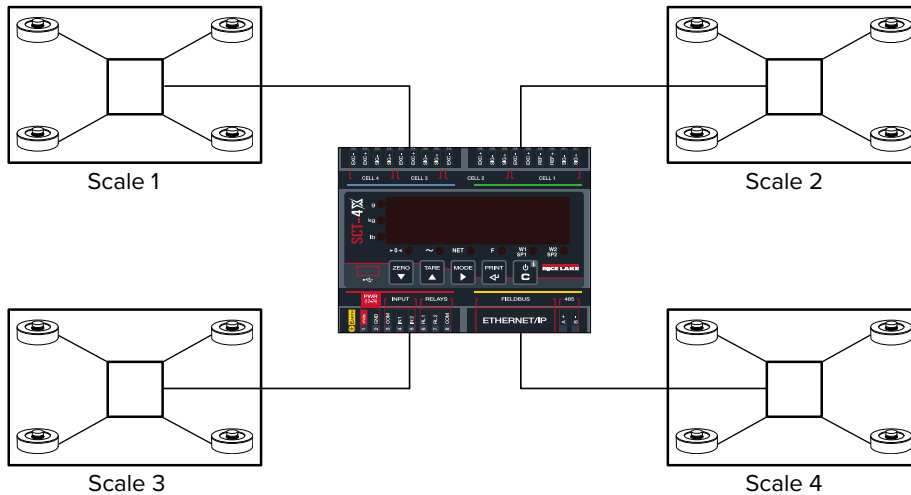

**i** Change displayed scale by pressing Mode for 2 seconds, use Zero and Tare to select, and then press Print to confirm.

# ADC Pre-calibration

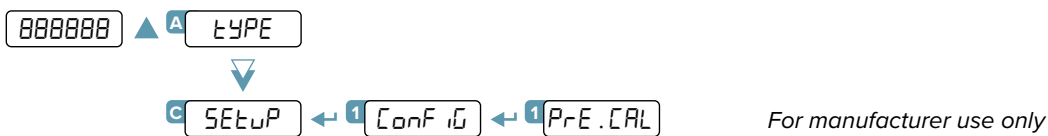

### LEGEND:

- ▼ Indicates repeated pressing of the ▼ key.
- 👁 Parameter visible only under certain conditions.
- 🔒 Parameter or menu subject to approval.
- ⚙ Default value of the parameter.

## Dependent channels

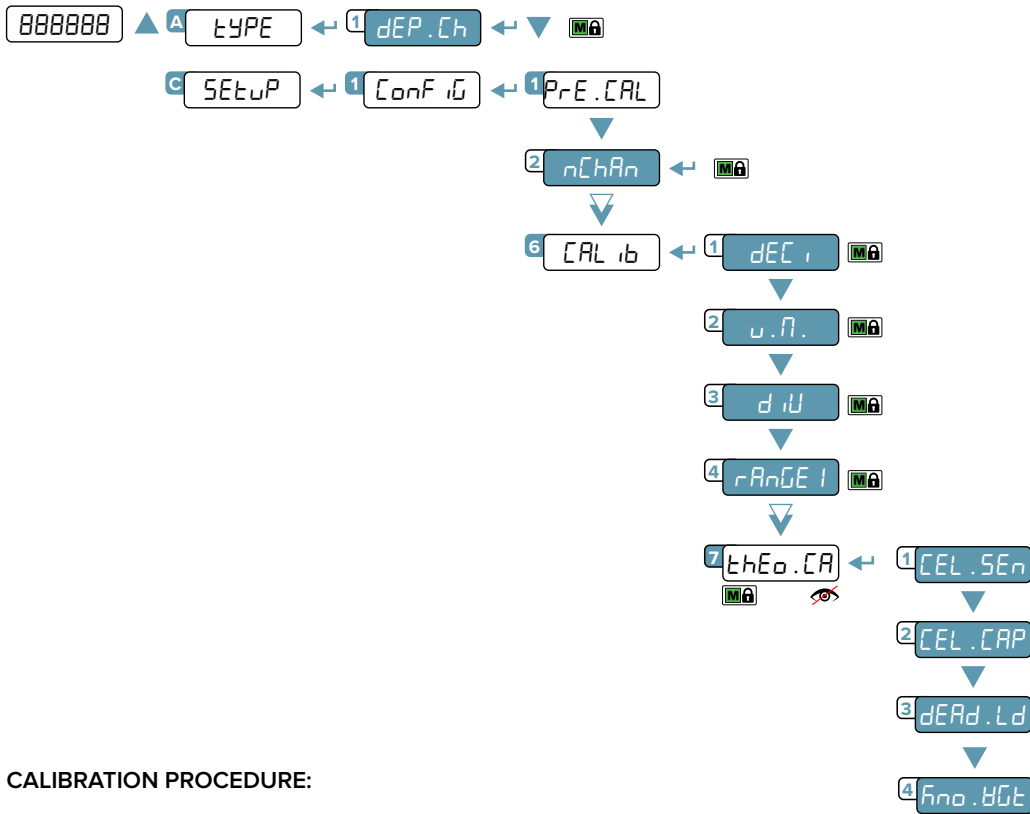

### CALIBRATION PROCEDURE:

1. Select mode of use *dEP.Ch*.
2. Set the number of channels used (from 1 to 4).
3. Set the calibration parameters:
  - dEC.* = Number of decimals.
  - u.n.* = Unit of measurement (FG, G, t, Lb).
  - d.u* = Minimum division.
  - rAnGE I* = Maximum range.
4. Set the cell data:
  - SEn.CEL* = Cell sensitivity (given by the sum of the mV/V value of each cell).
  - CEL.CAP* = Total capacity of the cells (given by the sum of the capacities of each cell).
5. Enter the weight value of the structure in the *dERd.Ld* parameter. If you do not know this value, enter "0".
6. If the structure contains a quantity of material whose weight value is known (e.g. full silo), enter this value in the *fno.HGT* parameter.
7. Application of theoretical calibration:
 

Press the **C** key to exit the calibration menu. The display shows *th.CALP*. Press the **←** key to confirm the use of the theoretical calibration, or the **C** key to cancel.



Complete menu  
on pages 21 - 22

#### MENU ACCESS:

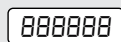

Press the **▲** key during the start-up procedure.

#### SAVING THE PARAMETERS:

Press the **C** key several times, until the display shows *SAUEP*. Press the **←** key to confirm.



# Independent Channels

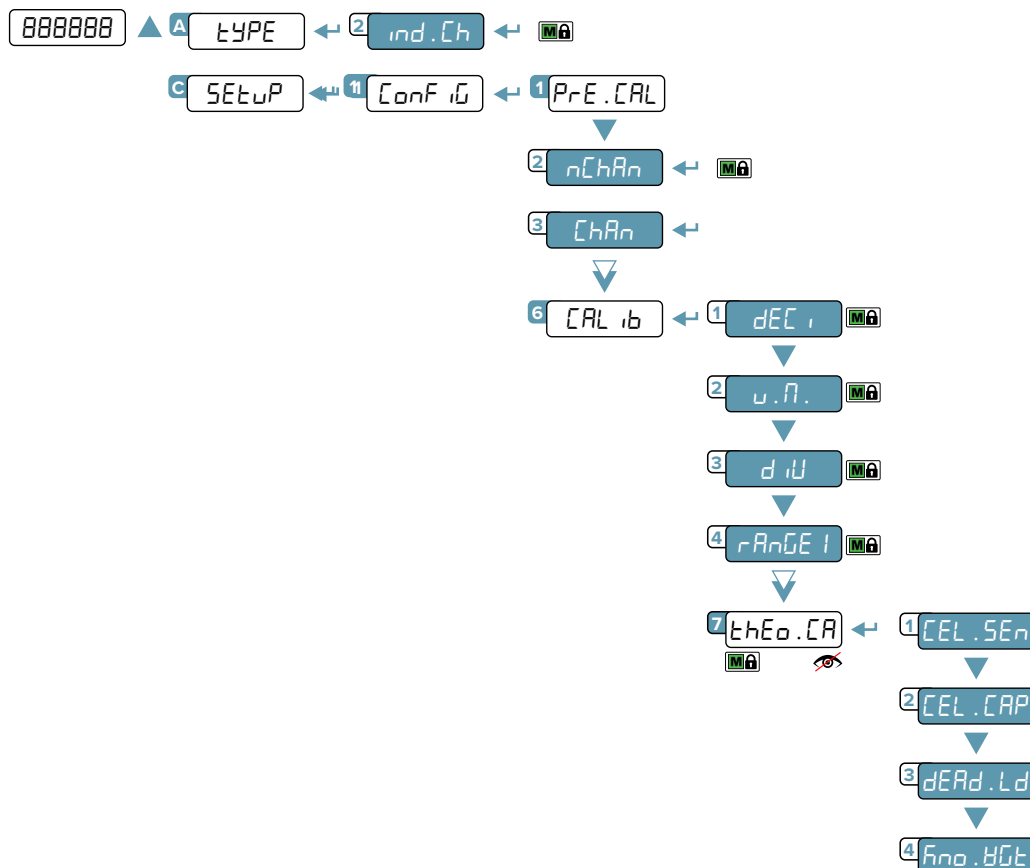





## CALIBRATION PROCEDURE:

1. Select mode of use *ind.Ch*.
2. Set the number of connected scales (from 1 to 4).
3. Select the scale to be calibrated (from 1 to 4).
4. Set the calibration parameters:
  - dEC i* = Number of decimals.
  - u.n.* = Unit of measurement (*KG, G, t, Lb*).
  - d iU* = Minimum division.
  - rAnGE I* = Maximum range.
5. Set the cell data:
  - SEn.CEL* = Cell sensitivity (given by the sum of the value of each cell).
  - CEL.CAP* = Total capacity of the cells (given by the sum of the value of each cell).
6. Enter the weight value of the structure in the *dERd.Ld* parameter. If you do not know this value, enter "0".
7. If the structure contains a quantity of material whose weight value is known (e.g. full silo), enter this value in the *Fno.HGT* parameter.
8. Application of theoretical calibration:
 

Press the **C** key to exit the calibration menu. The display shows *th.CAL?*. Press the **←** key to confirm the use of the theoretical calibration, or the **C** key to cancel.
9. Repeat the procedure from point 3 for each scale to be calibrated.

### LEGEND:

-  Indicates repeated pressing of the **▼** key.
-  Parameter visible only under certain conditions.
-  Parameter or menu subject to approval.
-  Default value of the parameter.

# Calibration with Sample Weights

## Dependent Channels (with Digital Equalization)

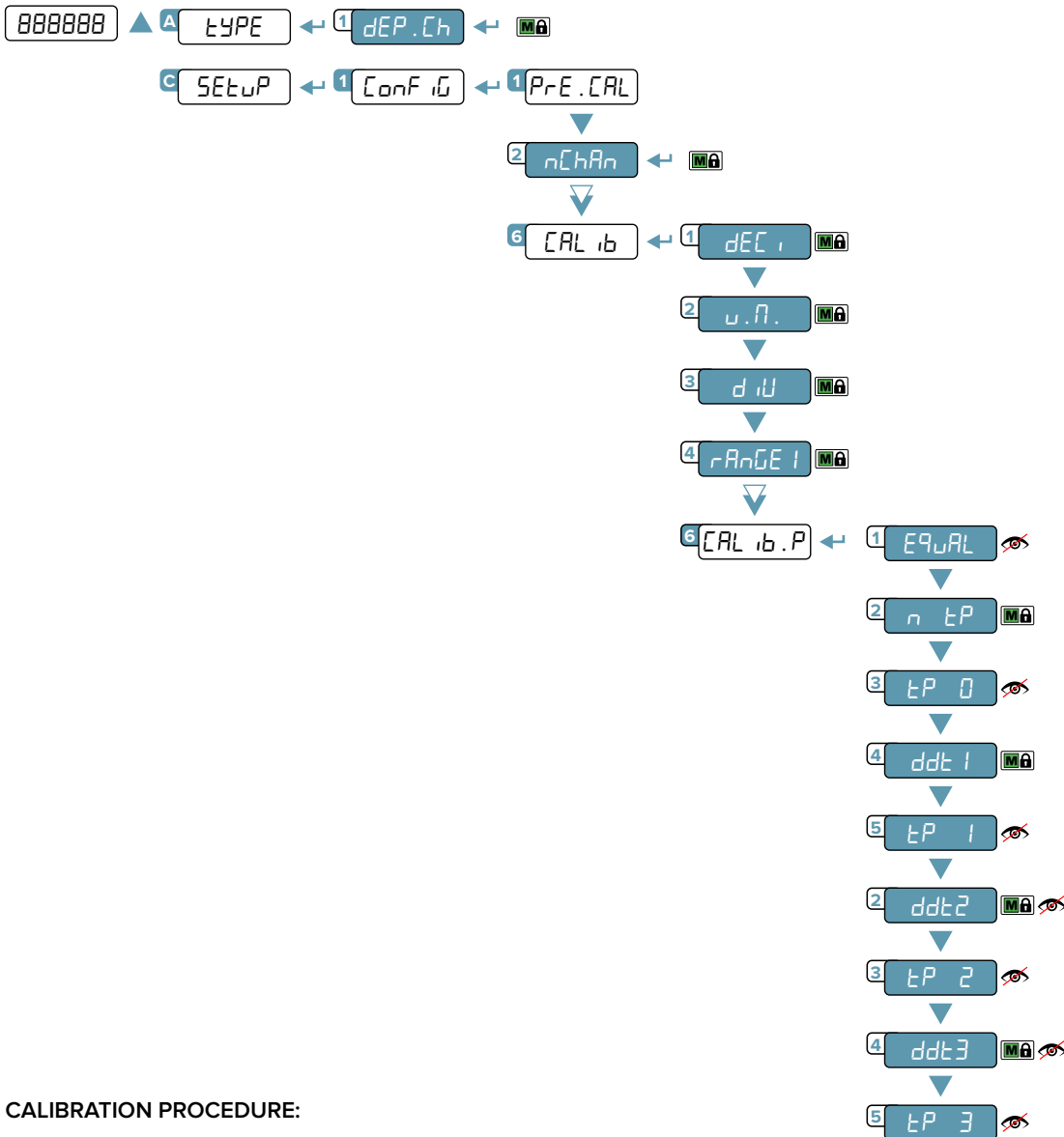

### CALIBRATION PROCEDURE:

1. Select mode of use *dEP.Ch*.
2. Set the number of connected scales (from 1 to 4).
3. Set the calibration parameters:
  - dEC i* = Number of decimals.
  - u.N.* = Unit of measurement (FG, G, t, Lb).
  - d iv* = Minimum division.
  - rAnGE 1* = Maximum range.
4. Equalise the cells.
 

**Attention:** The equalisation procedure is not compulsory. However, for a good accuracy of the system, it is recommended to perform it. To perform equalisation follow the instructions on **page 30**.
5. Acquire the calibration points (*continued on next page*)



Complete menu  
on pages 21 - 22

#### MENU ACCESS:

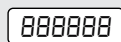

Press the key during the start-up procedure.

#### SAVING THE PARAMETERS:

Press the key several times, until the display shows *SAUEP*. Press the key to confirm.

5. Acquire the calibration points:

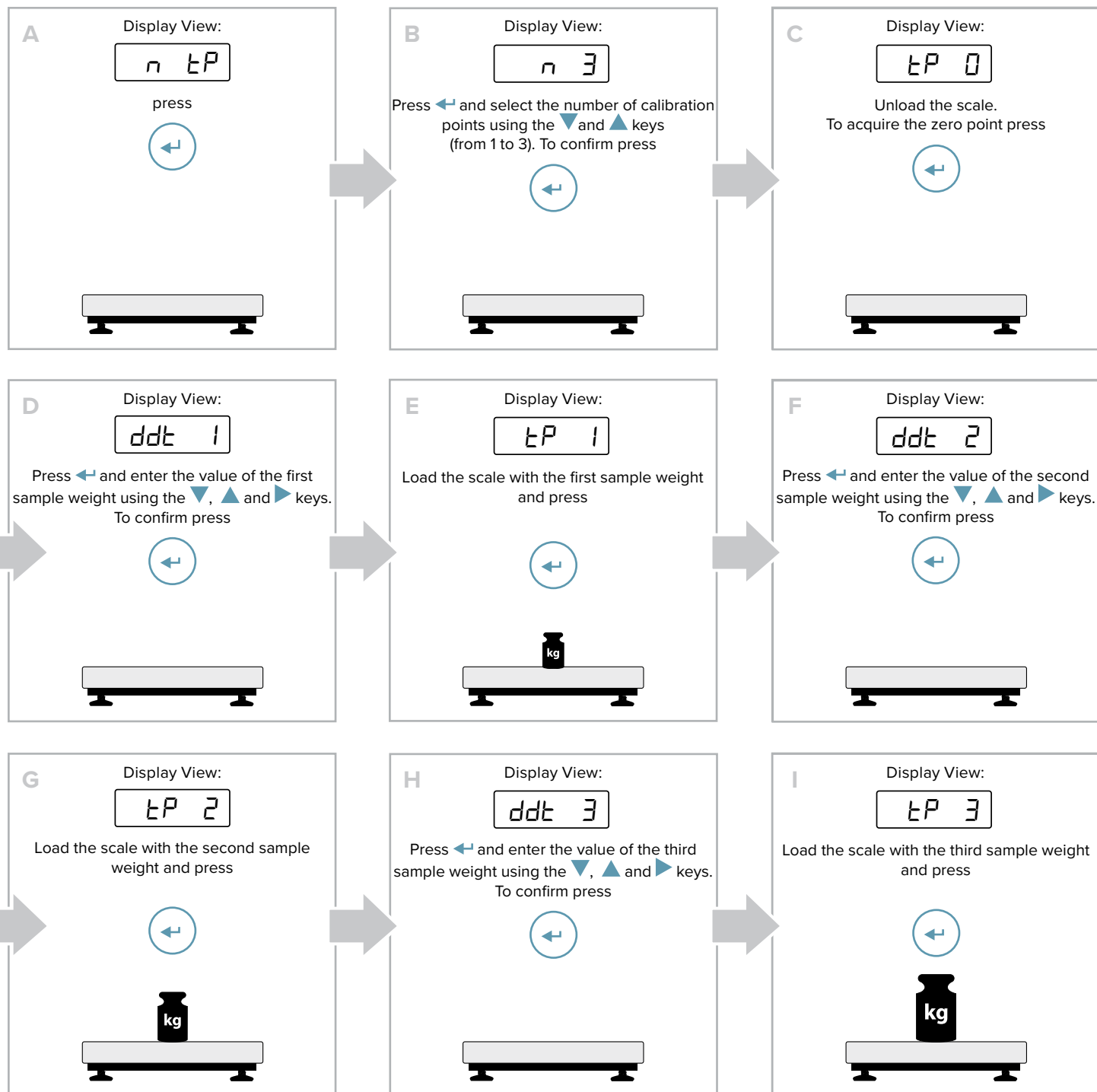

**i** For successful calibration, the value of the largest sample weight must be at least 50% of the capacity.

LEGEND:

- Indicates repeated pressing of the key.
- Parameter visible only under certain conditions.
- Parameter or menu subject to approval.
- Default value of the parameter.

# Independent Channels

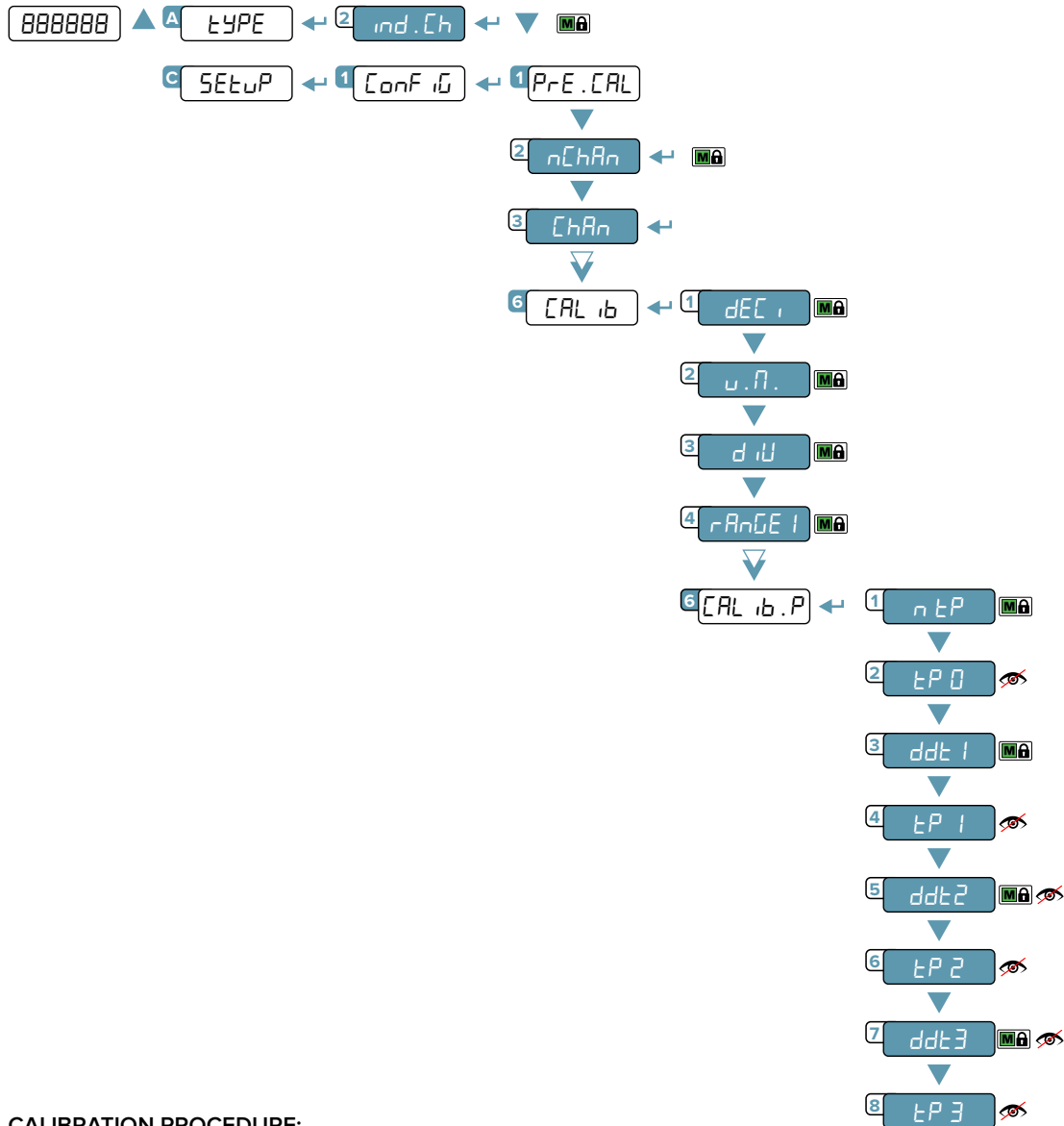

## CALIBRATION PROCEDURE:

1. Select mode of use *ind.Ch*.
2. Set the number of connected scales (from 1 to 4).
3. Select the scale to be calibrated (from 1 to 4).
4. Set the calibration parameters:
  - dEE i* = Number of decimals.
  - u.n.* = Unit of measurement (FG, G, t, Lb).
  - d.iU* = Minimum division.
  - rAnGE 1* = Maximum range.
5. Acquire the calibration points (*continued on next page*)



Complete menu  
on pages 21 - 22

### MENU ACCESS:

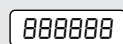

Press the ▲ key during the start-up procedure.

### SAVING THE PARAMETERS:

Press the C key several times, until the display shows SAUEP. Press the ← key to confirm.

5. Acquire the calibration points:

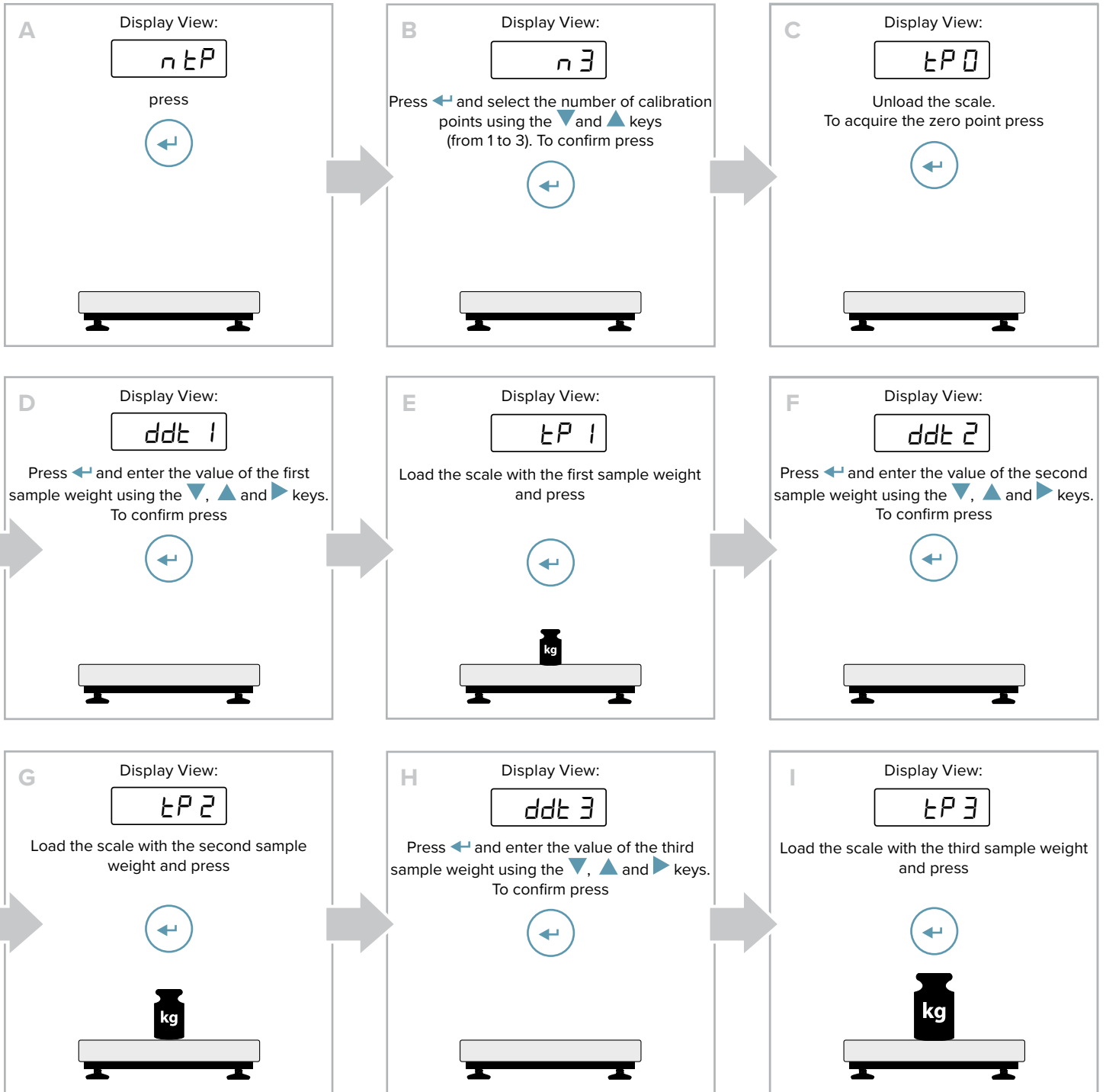

**i** For successful calibration, the value of the largest sample weight must be at least 50% of the capacity.

LEGEND:

- Indicates repeated pressing of the key.
- Parameter visible only under certain conditions.
- Parameter or menu subject to approval.
- Default value of the parameter.

# Equalization

If the dependent channel mode has been set, you can improve the accuracy of the system by digitally equalising the connected cells.

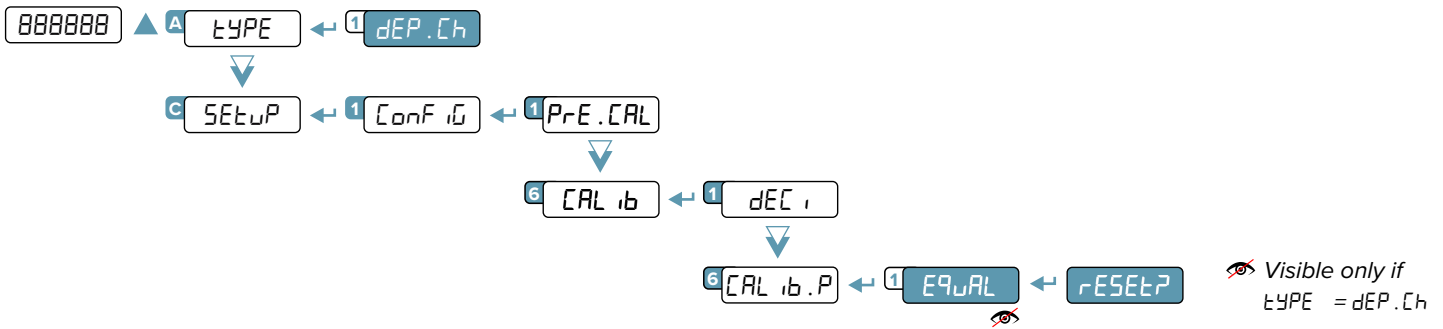

**A** Display View:  
E9 0

Completely unload the scale

Press

**B** Display View:  
E9 1

Load the equalisation weight\* so that it rests as much as possible only on cell 1

Press

**C** Display View:  
E9 2

Load the equalisation weight\* so that it rests as much as possible only on cell 2

Press

**D** Display View:  
E9 3

Load the equalisation weight\* so that it rests as much as possible only on cell 3

Press

(visible only if ChAn = 3)

**E** Display View:  
E9 4

Load the equalisation weight\* so that it rests as much as possible only on cell 4

Press

(visible only if ChAn = 4)

**F** Display View:  
E9 0h

When equalisation is complete the display shows the message E9 0h and automatically exits the equalisation menu.

n tP

**i** Equalisation can only be performed if the system is configured with dependent channels and calibration with sample weights is active.

**\*** For successful equalisation, it is advisable to use a compact weight with as small a supporting surface as possible, so that it rests as much as possible on only one cell. The weight value must be at least 20% of the capacity.

**MENU ACCESS:** 888888 ▲ Press the ▲ key during the start-up procedure.

**SAVING THE PARAMETERS:** Press the C key several times, until the display shows SEtUP. Press the ← key to confirm.

# Manual Calibration

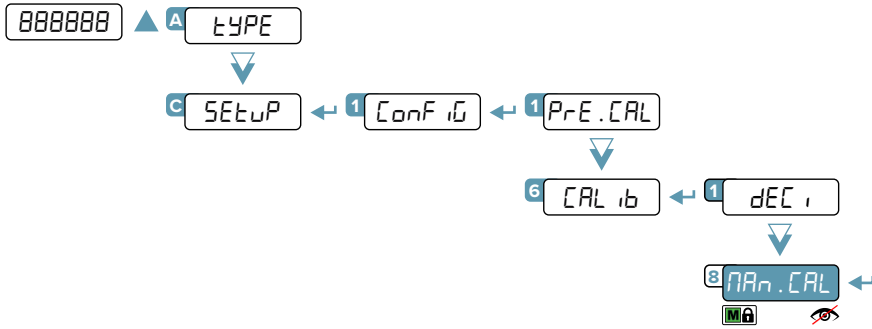

If you know the number of ADC converter points for a known weight (for example if you want to copy the calibration from one transmitter to another) the calibration points can be entered manually:

1. The display shows *Mod. Pnt*, proceed by pressing the  $\leftarrow$  key.
2. Using the  $\blacktriangle$  and  $\blacktriangledown$  keys, select the calibration point you want to enter / change (from 0 to 3). Press the  $\leftarrow$  key to confirm.
3. The display shows *WEIGHT*, use the  $\blacktriangle$ ,  $\blacktriangledown$  and  $\blacktriangleright$  keys to enter the weight value. Press the  $\leftarrow$  key to confirm.
4. The display shows *Points*, use the  $\blacktriangle$ ,  $\blacktriangledown$  and  $\blacktriangleright$  keys to enter the converter points value. Press the  $\leftarrow$  key to confirm.

**i** Repeat the procedure for each calibration point.  
If *ind.Ch* mode has been selected, the procedure must be repeated for each scale (Chan 2, 3, 4).

## Quick Zero Calibration (Pre-Tare Reset)

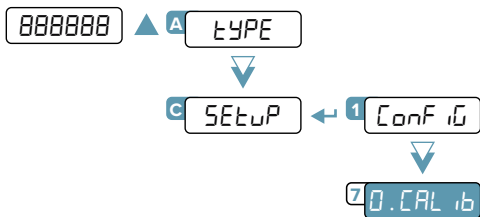

**i** If *ind.Ch* mode has been selected, it is first necessary to select the channel on which the zero calibration is to be performed (Chan 1, 2, 3, 4).

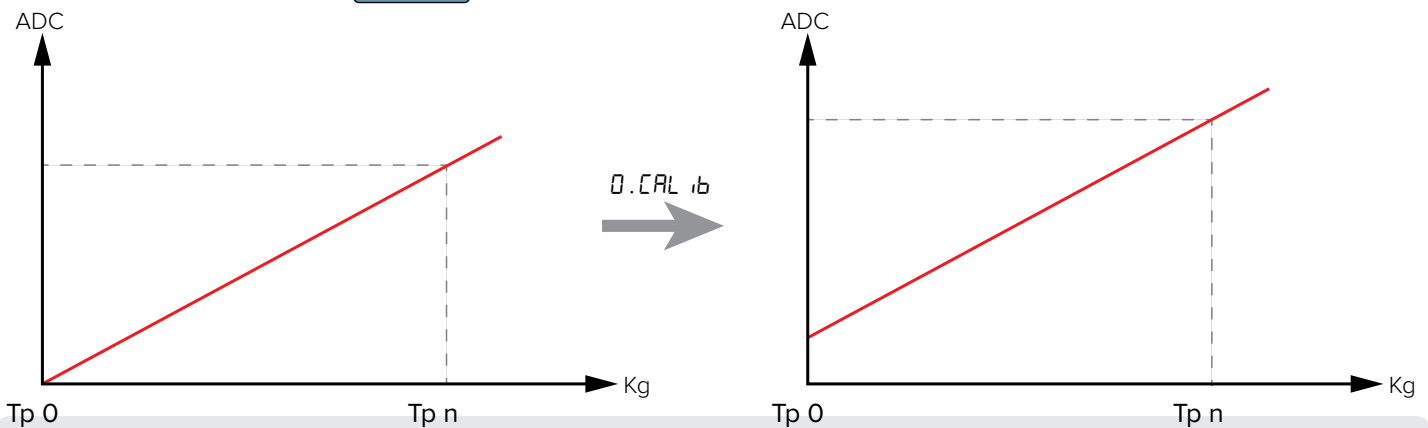

**LEGEND:**

- $\blacktriangledown$  Indicates repeated pressing of the  $\blacktriangledown$  key.
- $\text{eye}$  Parameter visible only under certain conditions.
- $\text{lock}$  Parameter or menu subject to approval.
- $\text{gear}$  Default value of the parameter.

## Filter Adjustment

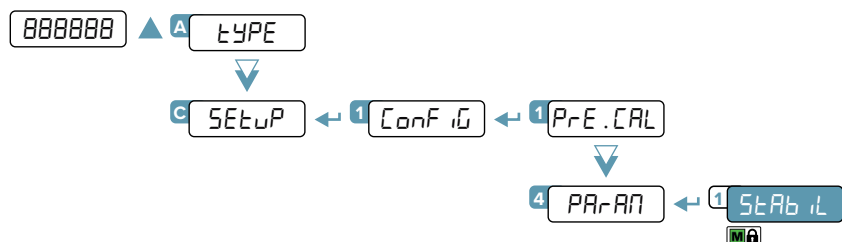

Filter	Updating frequency (Hz) *		Response time (ms)		Use
	1 channel	4 channels	1 channel	4 channels	
F 1	5	3	5000	8000	High resolution or Oscillating loads
F 2	10	5	2500	5000	
F 3	20	10	1000	2000	Simple weighing
F 4	40	17	450	1000	Dosing
F 5	80	30	300	800	
F 6	160	50	150	500	
F 7	325	100	50	150	High-speed weight transmission
F 8	650	*	35	*	
F 9	1300	*	20	*	
F 10	2600	*	10	*	

**i** In the case of a restricted transmitter, it is possible to select only filter F 3.

Filters F 8, F 9 and F 10 can be used only for applications with a single channel.

(\*) The filter affects the speed of the PC port only if ALL.PAH mode has been selected.

Complete menu on pages 21 - 22

**MENU ACCESS:**

888888 ▲ Press the ▲ key during the start-up procedure.

**SAVING THE PARAMETERS:**

Press the C key several times, until the display shows SETUP. Press the ← key to confirm.



## Anti-Peak Filter

The transmitter has an additional filter for the elimination of sudden weight peaks (e.g. shocks or falling material).

The following parameters, opportunely configured, allow you to eliminate the peak by blocking the weight for its entire duration.

The weight is blocked if it remains within the number of divisions set in  $PF.LF.dU$  for the time set in  $PF.LF.tN$  and is subsequently unblocked if the weight deviates from the blocking value for a number of divisions greater than  $PF.dU$  (o  $PF.bn.dU$ ) or if the time set in  $PF.tNE$  has elapsed.

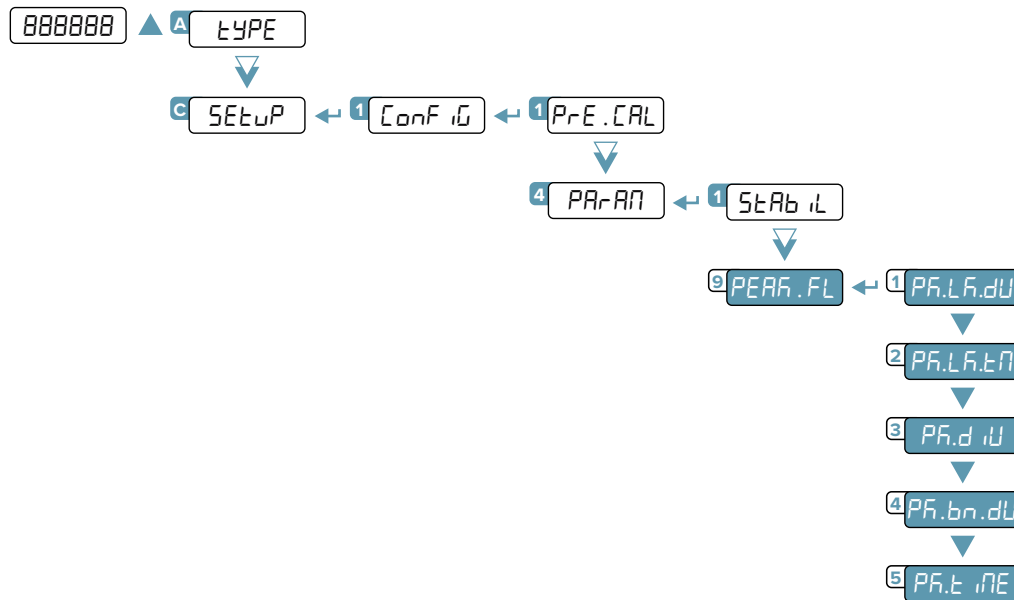

## Stability Detection Sensitivity

It is possible to decide that tare, zero and print functions (from keypad or serial command / PLC) are performed only if the weight is stable.

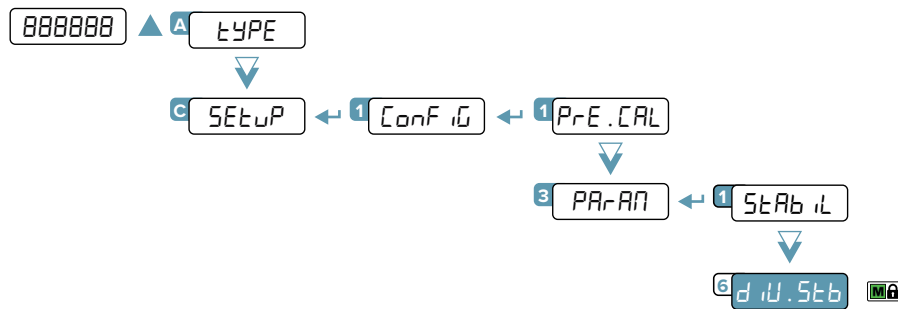

The value 0 disables the stability control.

By entering a value other than 0, you enable stability control.

Enter the number of deviation divisions beyond which the transmitter detects instability.

From 0 to 99.

⚙️ = 02.

🔒 = 02.

### LEGEND:

⏴ Indicates repeated pressing of the ⏴ key.

👁️ Parameter visible only under certain conditions.

🔒 Parameter or menu subject to approval.

⚙️ Default value of the parameter.

## Stability Detection Time

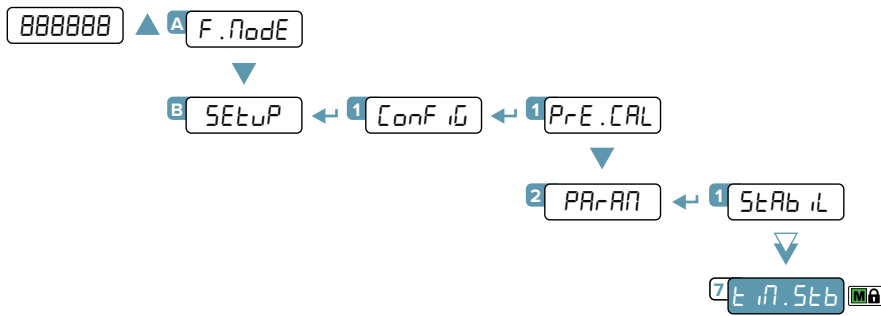



If the weight remains within the number of divisions set in *d iU .Stb* for the time set in this parameter, the weight is stable.

Enter the value in ms. In case of a restricted transmitter, the value is fixed at 500 ms.

from 10 to 10000.  
500.   
⚙️ = 500.

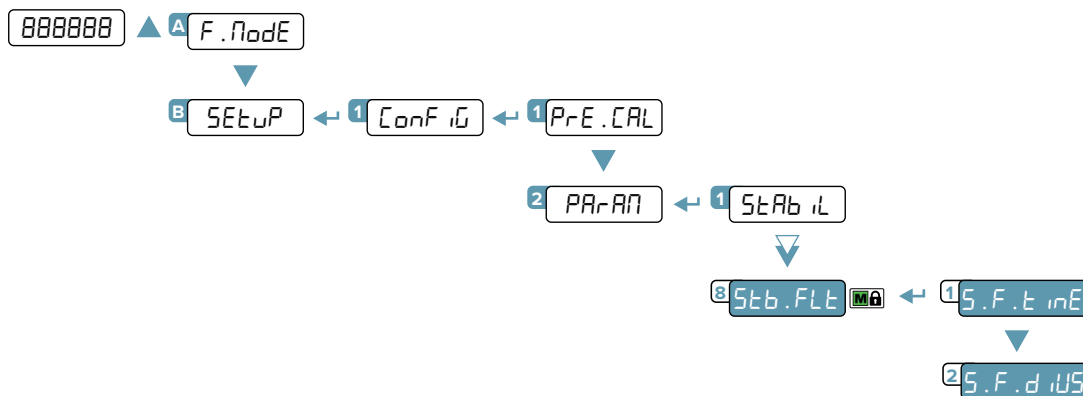
## Additional Filter for Stability Detection



from 0 to 2000.  
0.   
⚙️ = 0.

from 0 to 100.  
0.   
⚙️ = 0.

Additional filter that locks the weight if it oscillates around a value for a maximum of 10 divisions. The weight is unlocked if the value increases/decreases for the number of divisions set in the parameter S.T.DIVS for a time value greater than the time set in the parameter S.T.TIME.

The value 0 disables the filter.



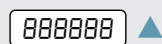

Complete menu  
on pages 21 - 22

### MENU ACCESS:



Press the  key during the start-up procedure.

### SAVING THE PARAMETERS:

Press the  key several times, until the display shows *SAUEP*. Press the  key to confirm.

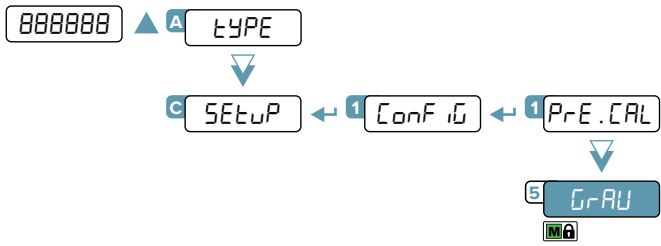

From 9.75001 to 9.84999.  
 ⚙️ = 9.80543.

This parameter allows you to correct the gravity acceleration value.  
 Before calibration, set the value of the calibration zone.  
 Next, set this value to the value of the zone of use.  
 Any difference between the two values will be automatically compensated.

**i** In the case of a restricted transmitter, the value is read-only.

**EXAMPLE:**



Calibration zone  
 Italy  
 g = 9.80543



Zone of use  
 Wisconsin  
 g = 9.80549

1. Before calibration, in the *GrAU* parameter enter the value 9.80543.
2. Calibrate the transmitter.
3. Before using the transmitter, in the *GrAU* parameter enter the value 9.80549.

**LEGEND:**

- Indicates repeated pressing of the key.
- Parameter visible only under certain conditions.
- Parameter or menu subject to approval.
- Default value of the parameter.

# Zero Functions and Parameters

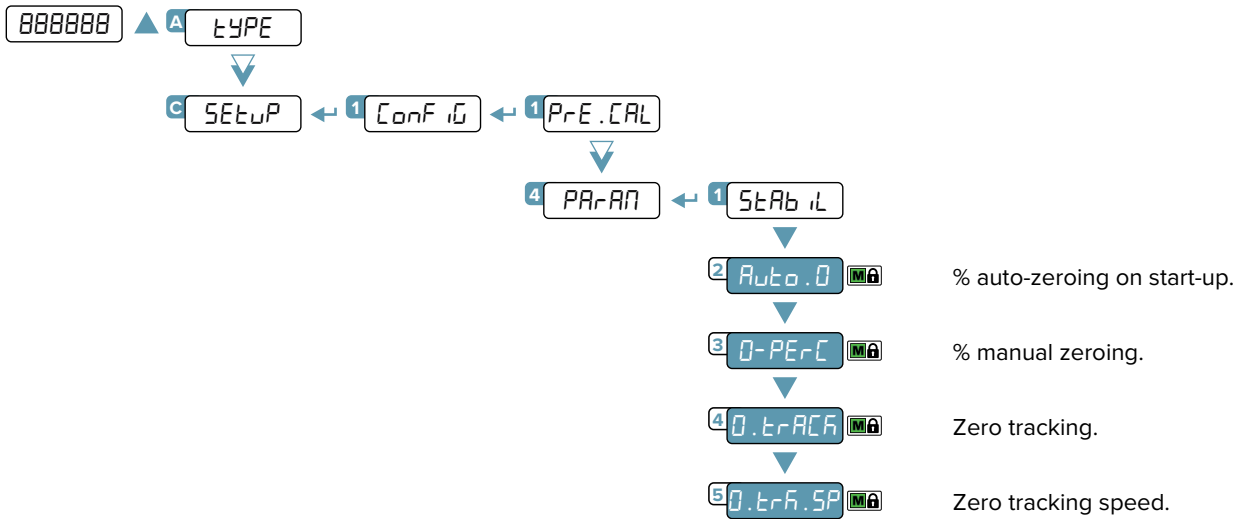

## Auto-Zeroing on Start-Up

2 **Auto.0** ← 1 **d,SAb** ⚙️ Disabled.

2 **EnAb** ← 1 **C.PERC** Enabled, enter in **C.PERC** the % value of the capacity. from 0 to 50%.  
from 0 to 10%. **M**

3 **CYCLE** ← 1 **C.PERC** In *ind.Ch* mode, it is possible to perform an auto-zeroing cycle of all connected scales. Enter in **C.PERC** the % value of the capacity. **M**

*👁️ Visible only if TYPE ≠ ind.Ch*

## Maximum Percentage of Manual Zeroing

3 **0-PERC** ← Indicates the weight value that can be zeroed by key or command. from 0 to 50%.  
The value is expressed as % of the full scale. For example: if the scale has a full scale (RANGE1) of 1000 kg, by setting 3% it is possible to zero up to 30 kg. from 0 to 2%. **M**  
The value 0 disables the ZERO key and the zeroing commands. ⚙️ = 2%.

## Zero Tracking

This menu allows to set zero tracking, i.e. the compensation parameter of the thermal drift of the scale; the set value corresponds to the number of divisions that is reset to zero in the time set in the parameter **0.trH.SP**.

- 4 **0.trACK** ← 1 **tr 10** 10 divisions.
- 2 **tr 8** 8 divisions.
- 3 **tr 6** 6 divisions.
- 4 **tr 4** 4 divisions.
- 5 **tr 2** 2 divisions.
- 6 **tr 1** 1 division.
- 7 **tr 1/2** ⚙️ 1/2 division.
- 8 **tr 1/4** 1/4 division.
- 9 **tr no** Tracking disabled.

**i** In the case of a restricted transmitter, it is possible to select the values *tr 1/2*, *tr 1/4*, *tr no*.

Complete menu on pages 21 - 22

**MENU ACCESS:** **888888** ▲ Press the ▲ key during the start-up procedure.

**SAVING THE PARAMETERS:** Press the **C** key several times, until the display shows **SAVEP**. Press the ← key to confirm.

## Zero Tracking Speed

0.trk.SP ←

It indicates the value of time that elapses from when the instrument detects stability to when zero tracking takes effect.  
The value is expressed in ms.

from 100 to 5000.  
from 1000. **M**  
⚙ = 1000.

## Restoring Zero

888888

▲ A TYPE

← C F.NoDE

1 Funct

0.r5.zEr0 ←

d.5Ab ⚙

Zero restoring disabled.

EnAb

Zero restoring enabled.

• If Auto.D = d.5Ab:

The last zero in the memory before turning off the power is always restored.

• If Auto.D = EnAb / CYCLE:

The last zero in the memory before turning off the power is restored only if the auto-zeroing fails.

## Semi-Automatic Zeroing

By pressing the ▼ key, or sending the zero command, the transmitter zeroes the gross weight on the scale. For a moment the display shows "zEr0" and then it shows 0 (gross weight).

The semi-automatic zeroing cannot be performed if:

- The weight on the scale is greater than the zero capacity (0.PErC).
- The weight is unstable.

### LEGEND:

- ▼ Indicates repeated pressing of the ▼ key.
- 👁 Parameter visible only under certain conditions.
- 🔒 Parameter or menu subject to approval.
- ⚙ Default value of the parameter.

# Tare Functions and Parameters

## Tare Mode

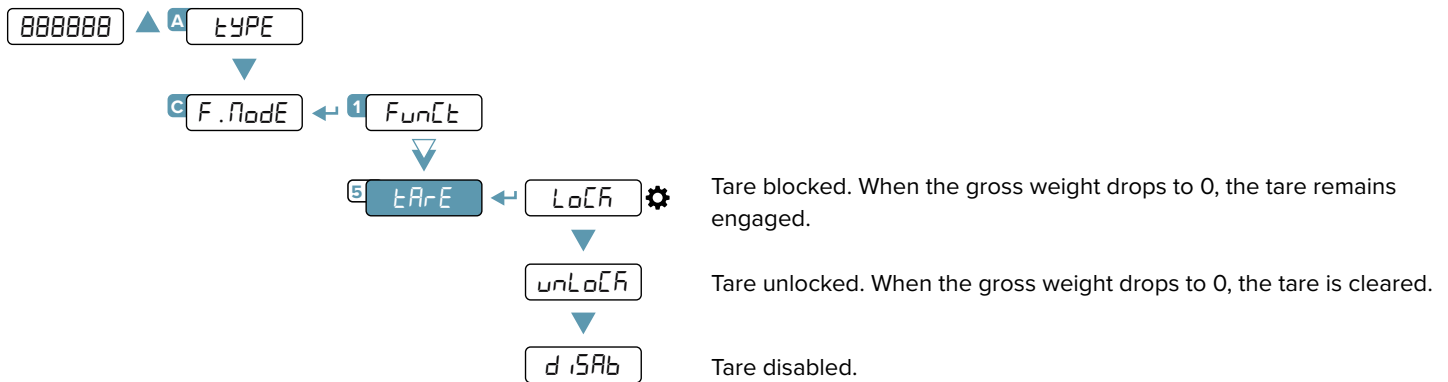

## Semi-Automatic Tare

By pressing the ▲ key, or sending the tare command, the transmitter sets as tare the weight on the scale. For a moment the display shows “TARE” and then it shows 0 (net weight). The **NET** light indicates that the net weight is shown on the display.

The semi-automatic tare cannot be performed if:

- The weight is less than one division.
- The weight is overloaded.

## Predetermined Tare

By holding down the ▲ key, or by means of the predetermined tare command, it is possible to enter a tare value manually. For a moment the display shows “-T-” and shows the tare present (or 0 if no tare is present). Enter the tare value and press ← to confirm.

## Clearing a Tare

The tare can be cleared in different ways:

- By unloading the scale and performing a semi-automatic tare.
- By entering a predetermined tare value of 0.
- If the weight is negative, pressing the ▼ key.

## Restoring a Tare

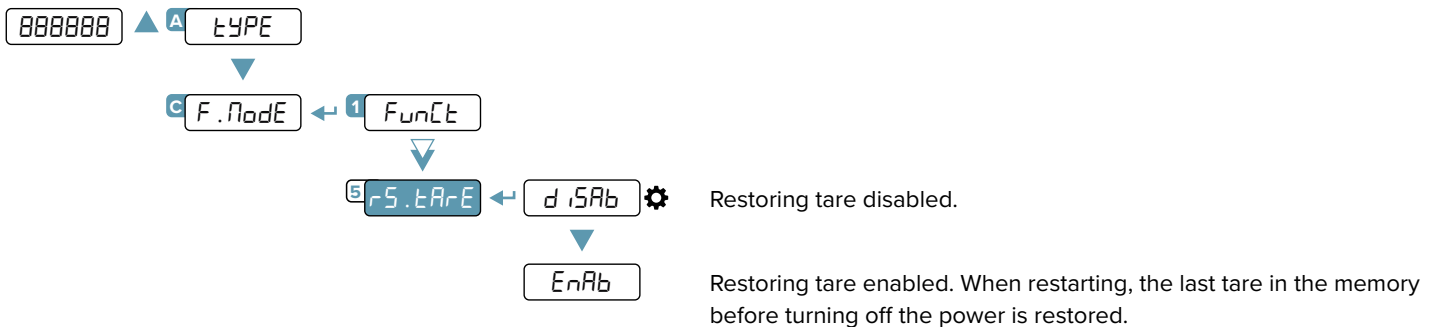

Complete menu  
on pages 21 - 22

### MENU ACCESS:

888888 ▲

Press the ▲ key during the start-up procedure.

### SAVING THE PARAMETERS:

Press the C key several times, until the display shows SAUEP. Press the ← key to confirm.

# Alibi Memory

The alibi memory allows you to store the weight values transmitted to the computer for further processing and/or data integration. The stored values can then be retrieved from the PC port or directly on the display of the transmitter for later checking.

## Enabling the Alibi Memory

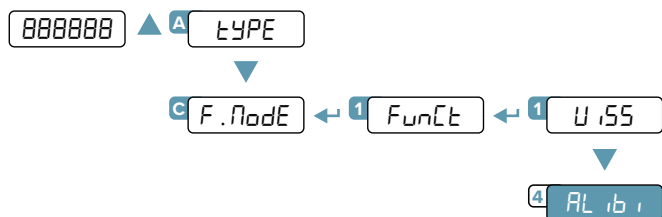

## Saving a Weighing Operation in Alibi Memory

A weighing operation is stored after receiving the PID serial command (see “Serial commands” page 54) or after pressing the key. The transmitter transmits on the PC port the gross weight, the tare and an ID code that uniquely identifies the weighing. The ID has the following format:

- rewrite number: 5-digit number (from 00000 to 00255) indicating the number of complete rewrites;
  - weighing number: 6-digit number (from 000000 to 131072) indicating the weighing number in the current rewrite.
- Each time it is saved, the weighing number is increased by 1; when it reaches the value 131072, it starts again from 000000 and the rewrite number is increased by 1.

### Example

If the weighing that has been saved is as follows:

**PIDST,1, 1.000lb, 1.000lb,00126-131072**

The next one will be:

**PIDST,1, 1.000lb, 1.000lb,00127-000000**

A weighing operation can only be saved if the weight  $\geq 0$ , stable and valid (not underloaded or overloaded). To store the weighing operation by key, the function must be active (see “Reactivating printing” on page 50). In addition, if the transmitter is restricted, the weight must exceed 20 divisions.

If these conditions are not met:

- the response to the PID command will have “NO” instead of the ID (PIDST,1, 1.000kg, 1.000kg,NO);
- there is no transmission when the key is pressed.

### LEGEND:

- Indicates repeated pressing of the key.
- Parameter visible only under certain conditions.
- Parameter or menu subject to approval.
- Default value of the parameter.

# Reading Alibi Memory

## FROM THE TRANSMITTER (MANUAL)

By pressing the **▶** key you can read a saved weight:

you will be asked to enter the rewrite number “rEH . id” (from 0 to 255) and the ID number “ id” (from 0 to 131072).

The weighing data are shown. Use the **▼** and **▲** keys to scroll through the following information:

- “Ch . X”, where X indicates the scale number.
- “un YY”, where YY indicates the unit of measurement (Fg, G, t or Lb).
- “Gross”, followed by the gross weight.
- “TARE / TAREPL”, followed by the tare value.

Press the **C** key to return to weighing.

The weighing of an ID can only be verified if:

- it has a rewrite number equal to the current alibi memory number and a weighing number ≤ the last value received with the PID command;
- it has a rewrite number ≥ 0, but 1 less than the current alibi memory value, and a weighing number greater than the last value received with the PID command.

## FROM PC

To read a weighing operation from a PC, see the serial command “READING A WEIGHING OPERATION IN THE ALIBI MEMORY” on page 54.

## FROM PLC

To read a weighing operation from a PLC, refer to the Modbus and Fieldbus protocol manuals.

**i** If the alibi memory is empty, when the **▶** key is pressed the display shows “EMPTY” for one second and returns to weighing mode. If an invalid ID is entered, the display shows “no id” and returns to weighing mode.

# Initializing Alibi Memory

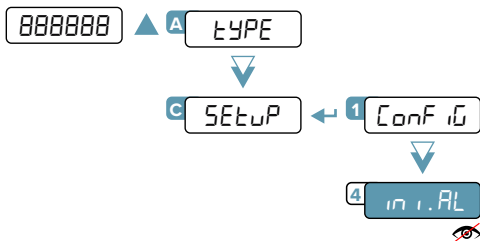

 Not visible if the transmitter is legal for trade.

**i** This operation deletes all saved weighing operations; it is not possible to delete a weighing operation individually.



Complete menu  
on pages 21 - 22

### MENU ACCESS:

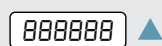

Press the **▲** key during the start-up procedure.

### SAVING THE PARAMETERS:

Press the **C** key several times, until the display shows **SAVEP**. Press the **←** key to confirm.



# User Functions

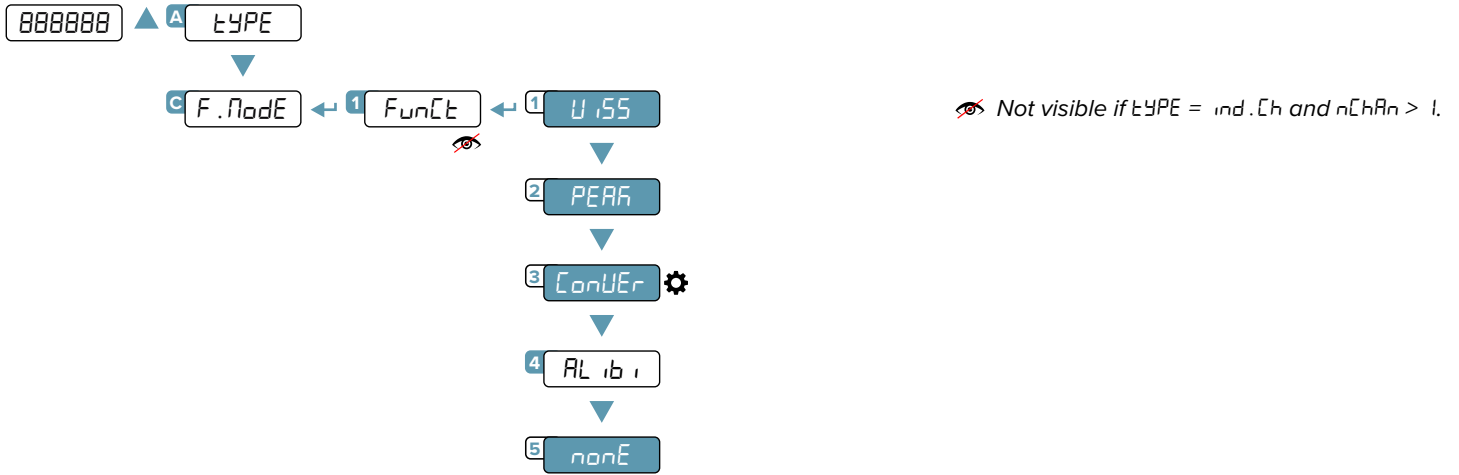

## High Resolution

U.55

Weight display in high resolution (x10). Press the key to activate or deactivate the function.

When the weight is displayed in high resolution, the **F** light is lit.

In the case of a restricted transmitter, the high-resolution weight display is automatically deactivated after 5 seconds.

## Peak Detection

PEAK

Detection of the maximum weight value during a time interval. Press the key to activate the function. The display shows “-PEAK-” every 5 sec and the transmitter shows the maximum weight reached since the function was activated.

To deactivate the function press the again, the display shows “PEAKoF” for a moment and shows the instantaneous weight again.

## Converting Units of Measure

conVEr

Converting the scale unit of measurement using a free conversion factor. Press the key to convert the weight to pounds. By holding down the key, you can enter a free conversion factor, which will be multiplied by the weight.

**Example:** to make the display show the cubic meters of water on the scale, enter the value 997 as the conversion factor. The key can be used to switch from the main unit of measurement to the secondary unit at any time.

When the secondary unit of measurement is displayed, the **F** light is lit.

## Alibi Memory

ALibi

(See section “Alibi memory” page 40).

## No Function

nonE

No function when the key is pressed.

### LEGEND:

- Indicates repeated pressing of the key.
- Parameter visible only under certain conditions.
- Parameter or menu subject to approval.
- Default value of the parameter.

# Input Configuration

The indicator has 2 configurable inputs (bidirectional optocouplers).

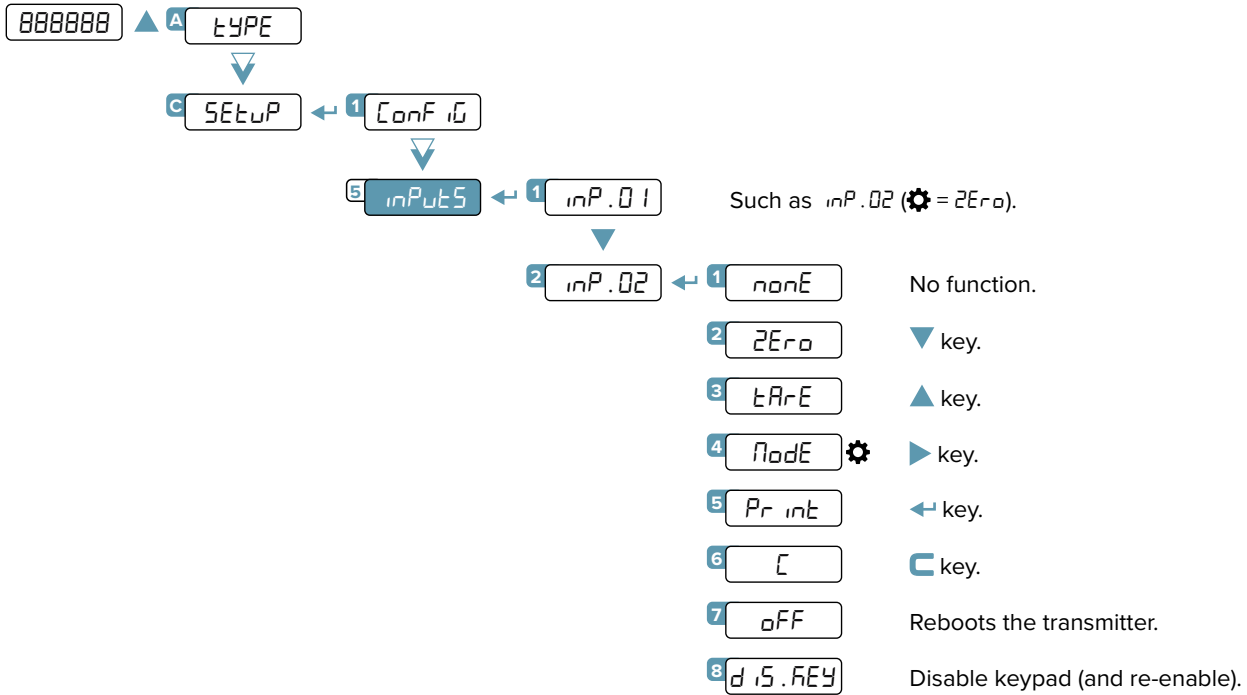

## INPUT CONNECTION:

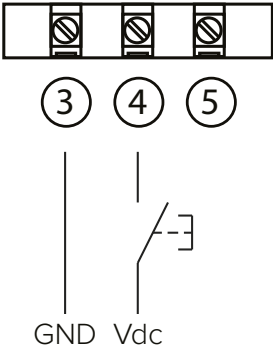

**i** The input is activated when there is a potential difference between terminals 4 - 5 (IN1 and IN2) and terminal 3 (INCOM). The inputs are bidirectional, therefore it is possible to invert GND and Vdc.



Complete menu  
on pages 21 - 22

### MENU ACCESS:

888888

▲ Press the ▲ key during the start-up procedure.

### SAVING THE PARAMETERS:

Press the C key several times, until the display shows `SAUEP`. Press the ◀ key to confirm.

# Output Configuration

The indicator has 2 programmable outputs (photomosfet).

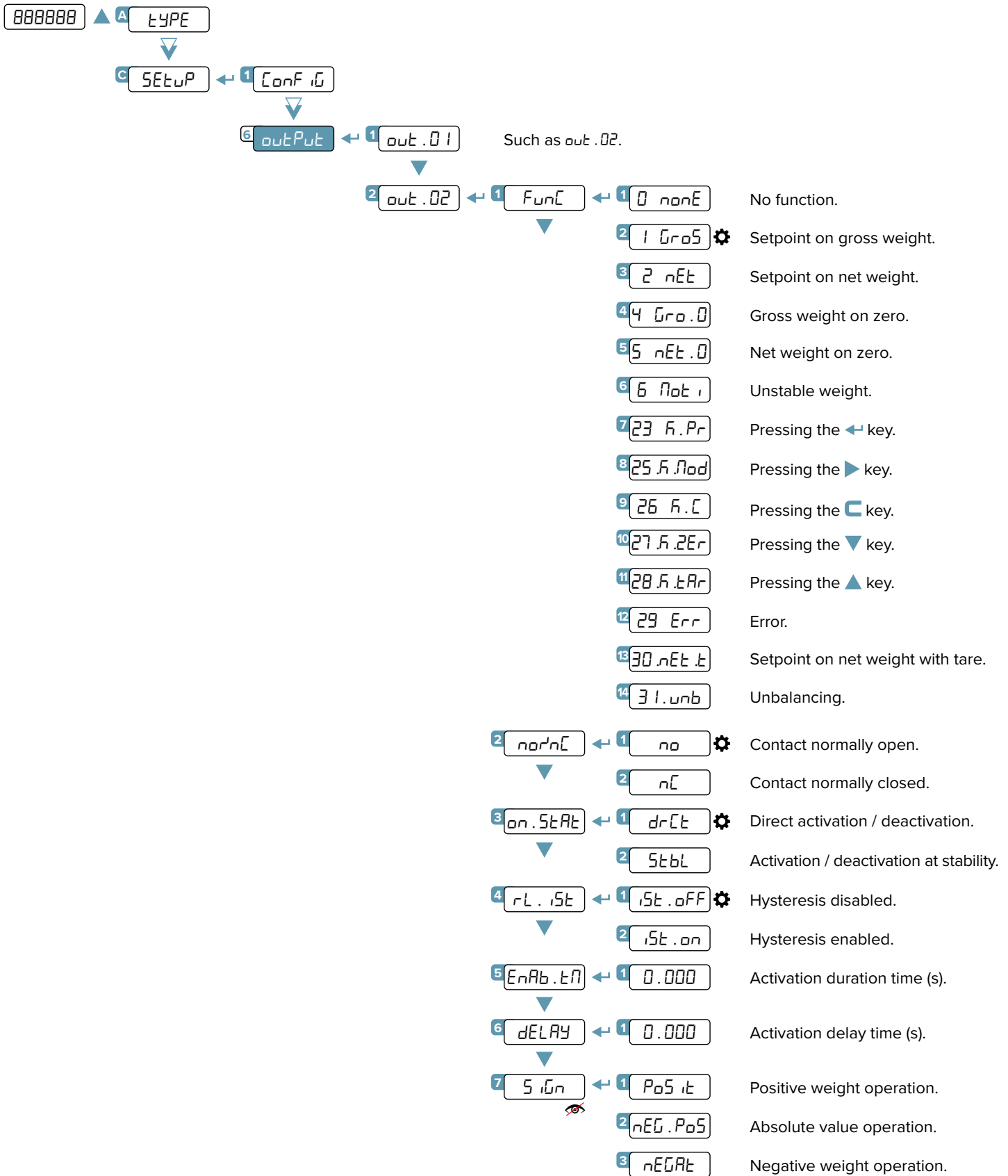

**LEGEND:**

- Indicates repeated pressing of the ▼ key.
- Parameter visible only under certain conditions.
- Parameter or menu subject to approval.
- Default value of the parameter.

# Analog Output Configuration

The SCT-4X-AN model has an analog output in voltage (0 - 5 / 0 - 10 VDC) or current (4 - 20 / 0 - 20 mA).

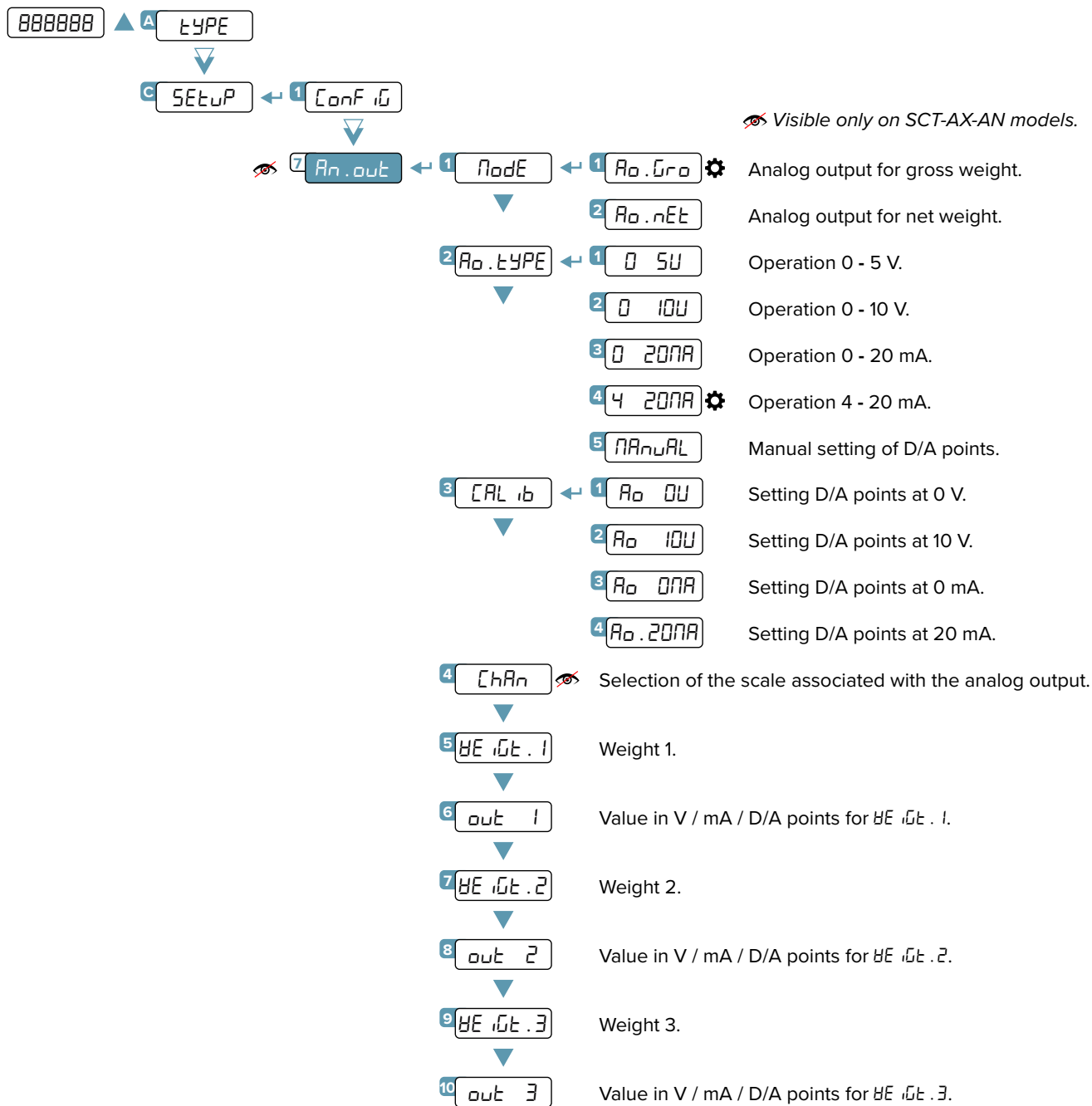

**i** This menu allows an advanced configuration of the analog output.  
 For simple configurations, it is recommended to use the quick menu (Ref. **Quick Start Guide**).

**Complete menu** on pages 21 - 22

**MENU ACCESS:** **888888** Press the key during the start-up procedure.

**SAVING THE PARAMETERS:** Press the **C** key several times, until the display shows **SAVEP**. Press the key to confirm.

**CALIBRATION PROCEDURE:**

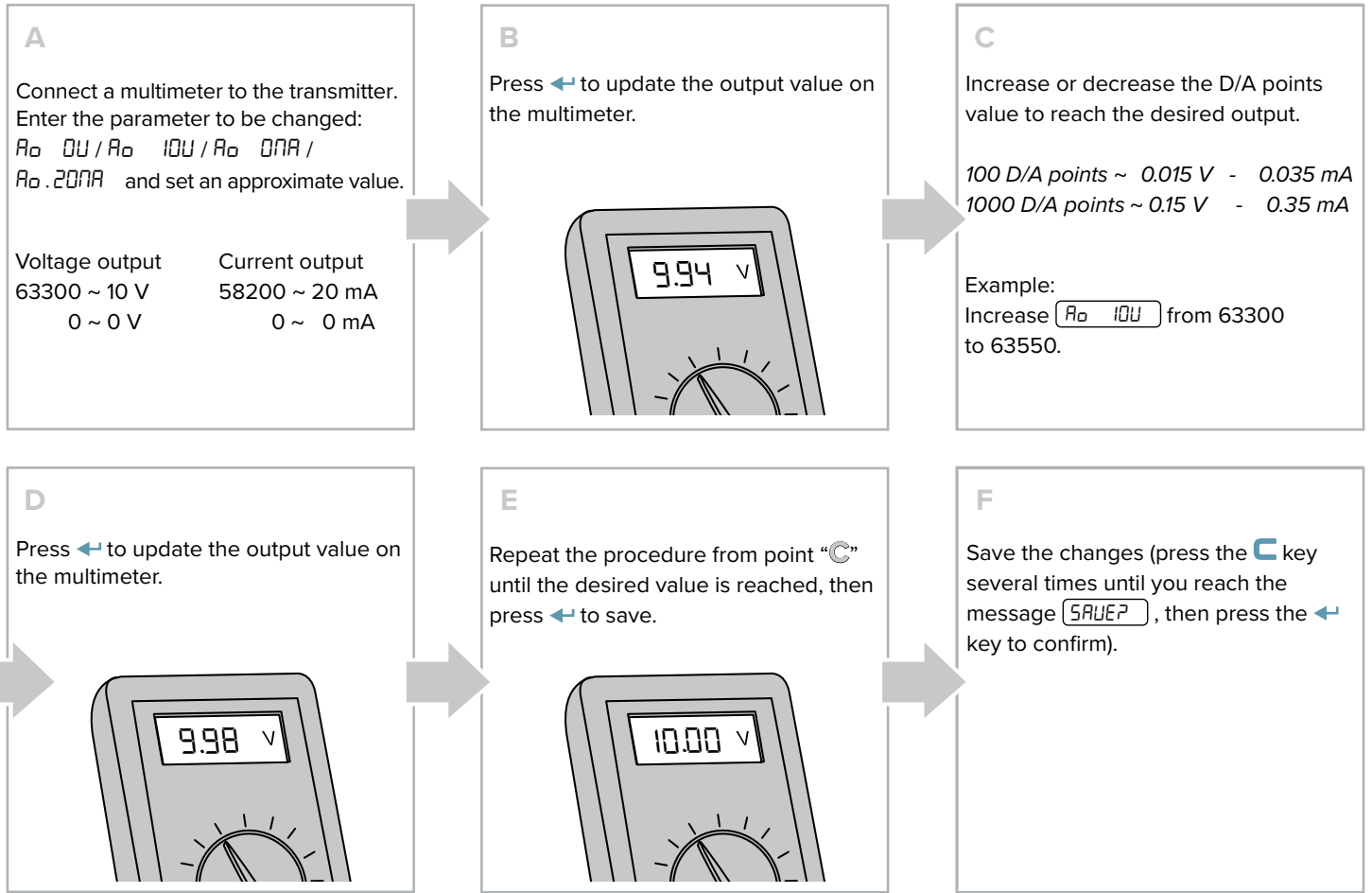

**ANALOG OUTPUT GRAPHS:**

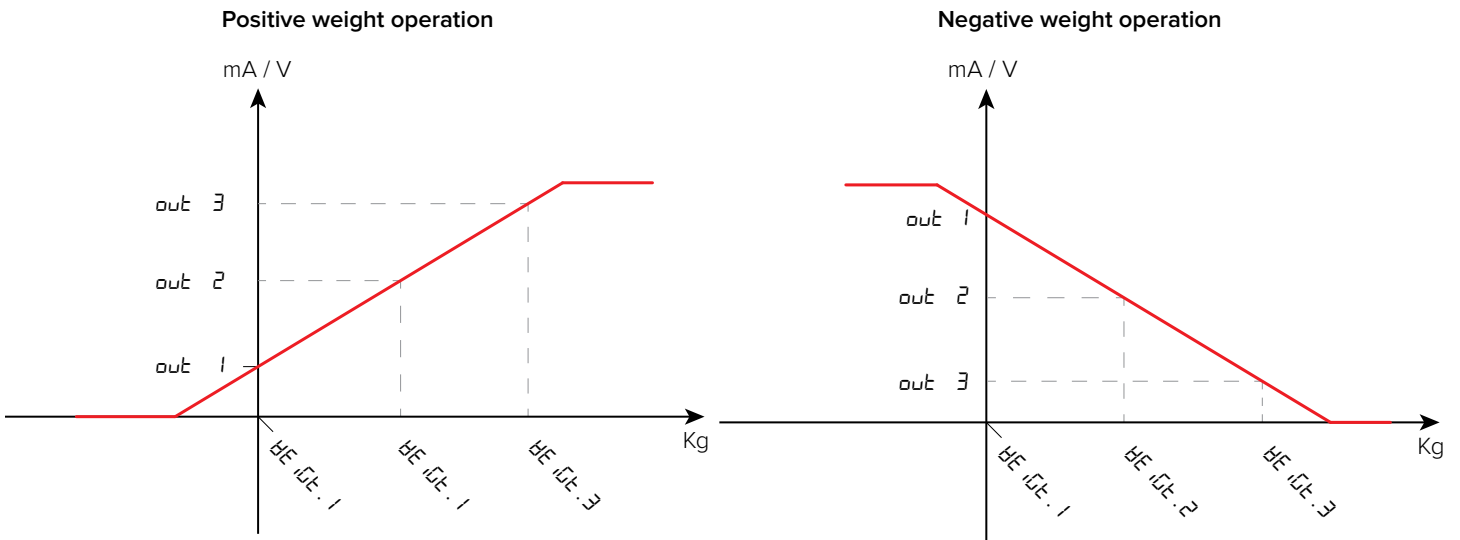

**i** Voltage or current operation is determined by the connection to the transmitter terminals:  
Current: 9 (+) and 10 (-).  
Voltage: 11 (+) and 12 (-).

**LEGEND:**

- Indicates repeated pressing of the key.
- Parameter visible only under certain conditions.
- Parameter or menu subject to approval.
- Default value of the parameter.

# Serial Communication Configuration

The transmitter has 3 serial ports (COM1 / 232, COM2 / 485, USB) that can be used indiscriminately to communicate:

- In bidirectional mode with the PC / PLC ("PC" port);
- In one-directional mode with the PC, thermal printer, repeater ("PRN" port);

The USB port always allows quick connection to the PC to change / save / restore the transmitter settings at any time.

It is necessary to choose which port to use as PC and, consequently, which one to use as PRN.

## Selection of the PC serial port

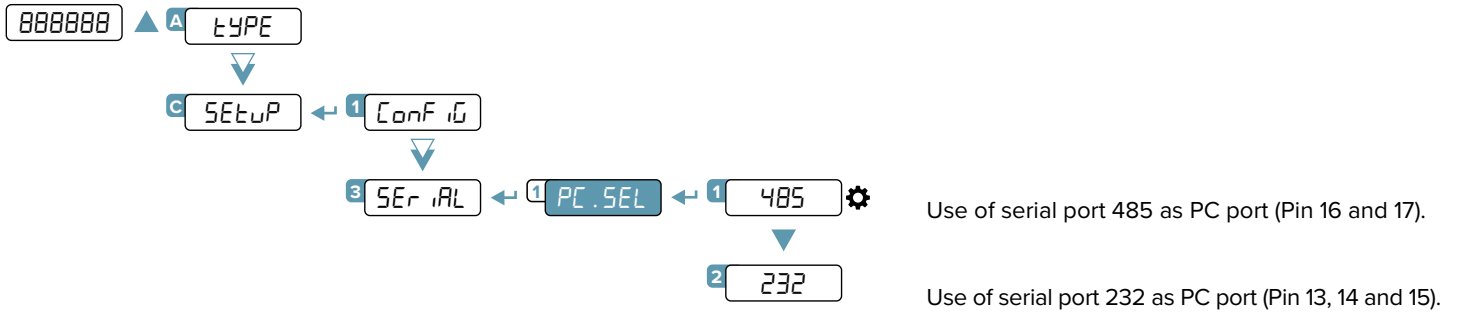

**i** Port 232 is not available on models **SCT-4X-MODTCP**, **SCT-4X-PRONET** and **SCT-4X-ETHIP**.



Complete menu  
on pages 21 - 22

### MENU ACCESS:

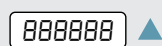

Press the ▲ key during the start-up procedure.

### SAVING THE PARAMETERS:

Press the C key several times, until the display shows **SAUEP**. Press the ← key to confirm.

# Printer Port (COM.PRN) Configuration

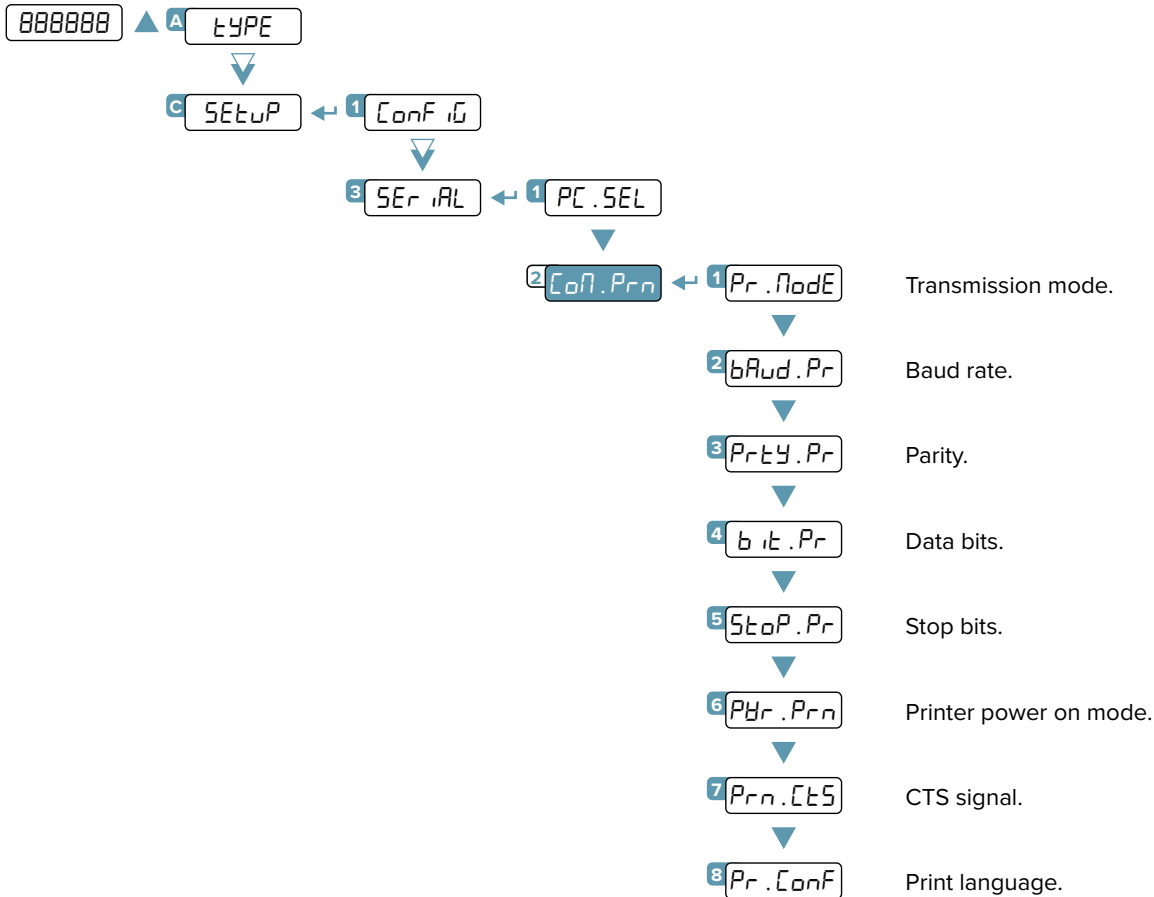

## Transmission mode

- 1 Pr .ModE ← 1 Pr-no ⚙️ Transmission not enabled.
- 2 PrPC .hH Transmission of the weight value when the ← key is pressed.
- 3 rEPE .6 Transmission of the 6-digit weight.
- \* 4 PrPC .EH Extended string transmission when the ← key is pressed.
- \* 5 PrPC .St Standard string transmission when the ← key is pressed.
- 6 ALL .EHt Continuous transmission of the extended string.
- \* 7 ALL .Std Continuous transmission of the standard string.
- 8 tPr Enables printing on a printer.

**i** For the specifications of transmission modes, strings and protocols see the section “TRANSMISSION PROTOCOLS”. Setting *Pr .ModE* = *rEPE .6* automatically sets the serial port to 4800, N-8-1. It is however possible to set it differently.

\* When selecting one of these protocols, you are asked if you want to display the 485 address at the beginning of the string: *dEU . id* ← *YES / no*.

**LEGEND:**

- Indicates repeated pressing of the key.
- Parameter visible only under certain conditions.
- Parameter or menu subject to approval.
- Default value of the parameter.

## Baud Rate, Parity, Data Bits, Stop Bits

**2** **bAud.Pr** ← **1**  ⚙️

**2**

**3**

**4**

**5**

**6**

**7**

**8**

**3** **Prty.Pr** ← **1**  ⚙️ No parity, 8 data bits, 1 stop bit.

**2**  Even.

**3**  Odd.

**4** **bit.Pr** ← **1**  ⚙️ 8 bits.

**2**  7 bits.

**5** **StoP.Pr** ← **1**  ⚙️ 1 stop bit.

**2**  2 stop bits.

## Printer power on mode

It is possible to set the way the printer is turned on:

**6** **Prn.Prn** ← **1**  ⚙️ Printer always on.

**2**  Printer turned on at the time of printing.

## CTS signal

On serial port 232 there is the CTS (Clear to send) signal in pin 16.

**7** **Prn.CtS** ← **1**  ⚙️ CTS signal not managed.

**2**  Emulation of the CTS signal.

 visible only if  $Prn.Prn = EHt$



Complete menu  
on pages 21 - 22

### MENU ACCESS:

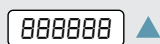

Press the ▲ key during the start-up procedure.

### SAVING THE PARAMETERS:

Press the **C** key several times, until the display shows **SAVEP**. Press the ← key to confirm.



## Print Language

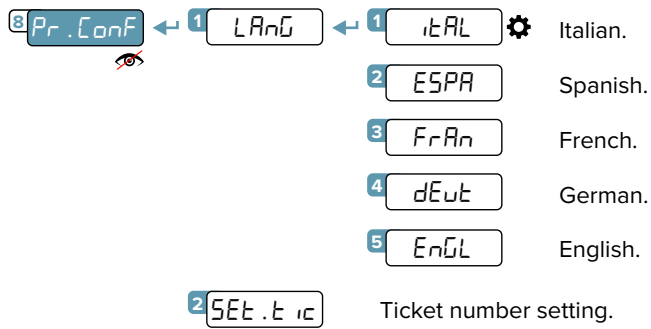

visible only if Pr.ModE = tPr

**i** Using the Rice Lake Tools software you can configure additional printing parameters.

## Printing Reactivation

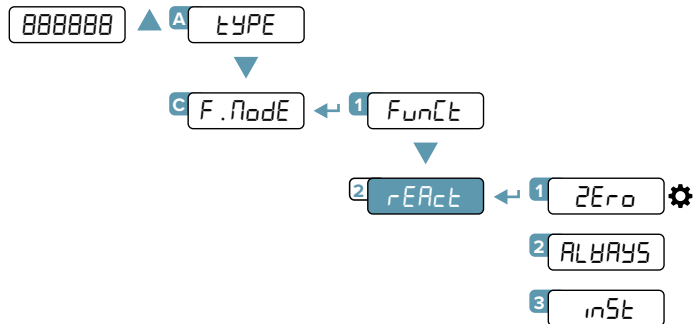

Reactivation of printing after the weight has changed from zero.

Printing always active.

Reactivation of printing after the weight has changed from instability.

### LEGEND:

- Indicates repeated pressing of the key.
- Parameter visible only under certain conditions.
- Parameter or menu subject to approval.
- Default value of the parameter.

# PC Port (COM.PC) Configuration

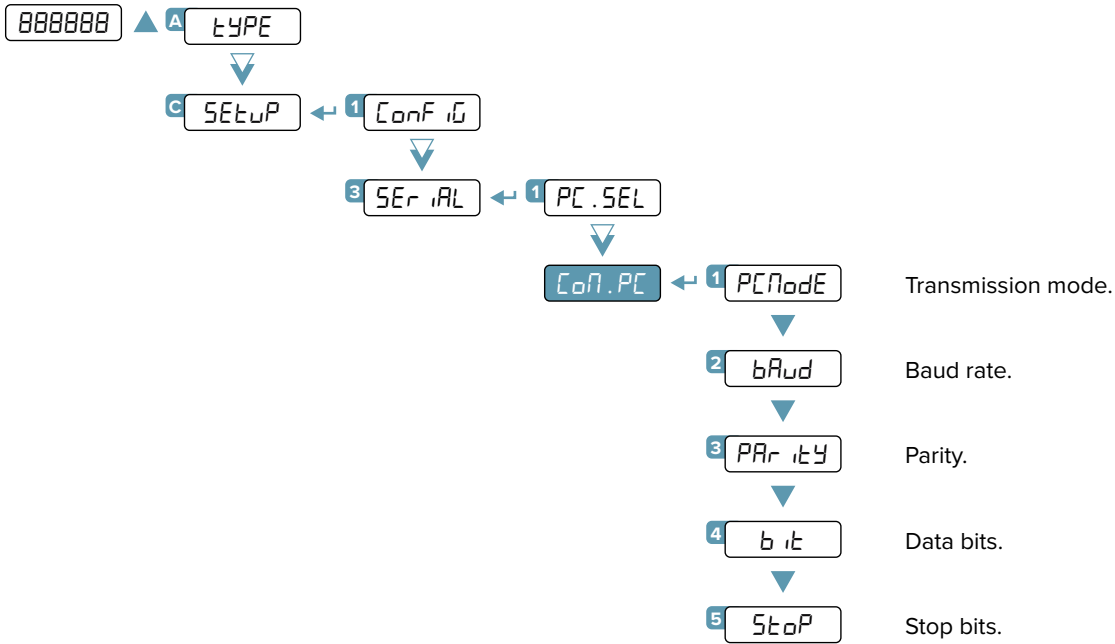

## Transmission Mode

- 1 PCModE ← 1 onDE Transmission on demand.
- 2 rEPE .6 Transmission of the 6-digit weight.
- \* 3 Pr in .St Standard string transmission when the ← key is pressed.
- \* 4 Pr in .EH Extended string transmission when the ← key is pressed.
- 5 485 Transmission with 485 protocol (enter the 485 address of the transmitter).
- \* 6 Modbus ⚙️ Transmission with Modbus protocol (refer to the Modbus protocol manual).
- 7 ALL .NAH Continuous high speed weight transmission for conversion applications.
- \* 8 ALL .Std Continuous transmission of the standard string.
- \* 9 ALL .EH Continuous transmission of the extended string.
- \* 10 StAb .St Stable transmission of the standard string.
- \* 11 StAb .EH Stable transmission of the extended string.

\* When selecting one of these protocols, you are asked if you want to display the 485 address at the beginning of the string: dEU . id ← YES / no.



Complete menu  
on pages 21 - 22

### MENU ACCESS:

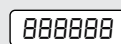

Press the ▲ key during the start-up procedure.

### SAVING THE PARAMETERS:

Press the C key several times, until the display shows SAUEP. Press the ← key to confirm.

## Baud Rate, Parity, Data Bits, Stop Bits

**2** **baud** ← **1** 9600 

**2** 4800

**3** 2400

**4** 1200

**5** 115200

**6** 57600

**7** 38400

**8** 19200

**3** **PARity** ← **1** none  No parity, 8 data bits, 1 stop bit.

**2** EVEN Even.

**3** odd Odd.

**4** **bit** ← **1** 8  8 bits.

**2** 7 7 bits.

**5** **stop** ← **1** 1  1 stop bit.



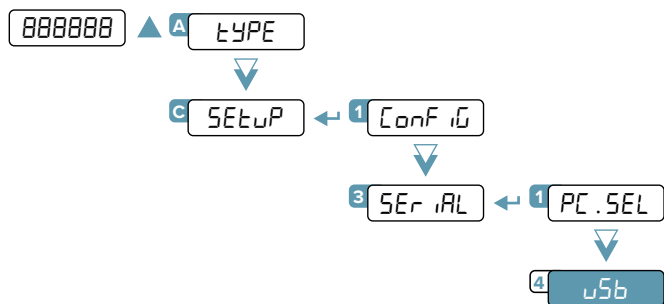

**2** 2 2 stop bits.

## USB Port Configuration



Useful for the configuration of the instrument from PC with Rice Lake Tools.

### LEGEND:

-  Indicates repeated pressing of the  key.
-  Parameter visible only under certain conditions.
-  Parameter or menu subject to approval.
-  Default value of the parameter.

## Standard String

[01]ST,GS, 0.0,kg<CR LF>

Where:

01	Transmitter code 485 (2 characters), only if communication mode 485 is enabled
ST	Scale status (2 characters): <u>US</u> - Unstable weight <u>ST</u> - Stable weight <u>OL</u> - Weight overload (out of range) <u>UL</u> - Weight underload (out of range)
,	Character ASCII 044
GS	Type of weight data (2 characters) <u>GS</u> - Gross <u>NT</u> - Net <u>VL</u> - Microvolts <u>RZ</u> - Converter points
,	Character ASCII 044
0.0	Weight (8 characters including the decimal point)
,	Character ASCII 044
kg	Unit of measurement (2 characters)
<CR LF>	Transmission terminator, characters ASCII 013 and ASCII 010

## Extended String

[01]1ST, 0.0,PT 20.8, 0,vv,01/02/19 11:12:13<CR LF>

Where:

01	Transmitter code 485 (2 characters), only if communication mode 485 is enabled
1	Number of the active scale
ST	Scale status (2 characters): <u>US</u> - Unstable weight <u>ST</u> - Stable weight <u>OL</u> - Weight overload (out of range) <u>UL</u> - Weight underload (out of range)
,	Character ASCII 044
0.0	Weight (8 characters including the decimal point)
,	Character ASCII 044
PT	Preset tare indication
20.8	Tare (8 characters including the decimal point)
,	Character ASCII 044
0	Character ASCII 048
,	Character ASCII 044
kg	Unit of measurement (2 characters)
,	Character ASCII 044
01/02/19 11:12:13	dd/mm/yy hh:mm:ss (only with REXD command and optional clock card)
<CR LF>	Transmission terminator, characters ASCII 013 and ASCII 010

# Multi-Scale String

If TYPE = ind.Ch and nChRn ≥ 2

[01]ST, 612,kg,ST, 61.4,t,ST, 6.17,g,ST, 0.617,lb<CR LF>

Where:

01	Transmitter code 485 (2 characters), only if communication mode 485 is enabled
ST	Scale 1 status (2 characters): <u>US</u> - Unstable weight <u>ST</u> - Stable weight <u>VL</u> - Microvolts <u>RZ</u> - Converter points ,
612	Scale 1 weight (8 characters including the decimal point) ,
kg	Scale 1 unit of measurement (2 characters) ,
ST	Scale 2 status (2 characters): <u>US</u> - Unstable weight <u>ST</u> - Stable weight <u>VL</u> - Microvolts <u>RZ</u> - Converter points ,
61.4	Scale 2 weight (8 characters including the decimal point) ,
t	Scale 2 unit of measurement (2 characters) ,
ST	Scale 3 status (2 characters): <u>US</u> - Unstable weight <u>ST</u> - Stable weight <u>VL</u> - Microvolts <u>RZ</u> - Converter points ,
6.17	Scale 3 weight (8 characters including the decimal point) ,
g	Scale 3 unit of measurement (2 characters) ,
ST	Scale 4 status (2 characters): <u>US</u> - Unstable weight <u>ST</u> - Stable weight <u>VL</u> - Microvolts <u>RZ</u> - Converter points ,
0.617	Scale 4 weight (8 characters including the decimal point) ,
lb	Scale 4 unit of measurement (2 characters)
<CR LF>	Transmission terminator, characters ASCII 013 and ASCII 010

# Serial Commands

By selecting the PC port on demand mode (*andÉ*), you can communicate with the transmitter via serial commands. For each command received, the transmitter emits a string containing the response (refer to the command description) or one of the following signals:

<b>OK</b> <CR LF>	Command sent when sending a correct command. This response does not imply that the command is executed.
<b>ERR01</b> <CR LF>	Command sent correctly but followed by letters entered unintentionally (e.g. READF, TARES).
<b>ERR02</b> <CR LF>	Incorrect command data.
<b>ERR03</b> <CR LF>	Command sent not allowed (transmitter busy, or not used in the selected operating mode).
<b>ERR04</b> <CR LF>	Command sent non-existent.

**i** If the 485 protocol has been selected, you must precede the command with the transmitter address (e.g. 01READ).

## WEIGHT READING (standard string)

<b>Format</b>	R   E   A   D   <CR LF>
<b>Response</b>	Standard string<CR LF>.

## EXTENDED OR MULTI-SCALE WEIGHT READING

<b>Format</b>	R   E   X   T   <CR LF>
<b>Response</b>	Extended string<CR LF>.

## WEIGHT READING IN HIGH RESOLUTION (X10)

<b>Format</b>	G   R   1   0   <CR LF>
<b>Response</b>	Standard string with weight in resolution x10 <CR LF>.

## AUTOMATIC TARE

<b>Format</b>	T   A   R   E   <CR LF>
<b>Response</b>	OK<CR LF> (or ERRxx).

## MANUAL TARE

<b>Format</b>	T   M   A   N   t   t   t   t   t   t   <CR LF>
<b>Where</b>	ttttt tare value
<b>Response</b>	OK<CR LF> (or ERRxx).

## ZEROING (of active channel)

<b>Format</b>	Z   E   R   O   <CR LF>
<b>Response</b>	OK<CR LF> (or ERRxx).

By entering a manual tare value of 0, the tare on the scale is cleared.

## DISABLING KEYPAD

<b>Format</b>	K   E   Y   E   D   <CR LF>
<b>Response</b>	OK<CR LF> (or ERRxx).

## ENABLING KEYPAD

<b>Format</b>	K   E   Y   E   E   <CR LF>
<b>Response</b>	OK<CR LF> (or ERRxx).

## READING INPUTS

<b>Format</b>	I   N   P   U   n   <CR LF>
<b>Where</b>	n Input (1 / 2).
<b>Response</b>	I   N   P   U   n   v   v   v   v   <CR LF>
<b>Where</b>	n Input number. vvv Input status: 0000 = Not active. 0001 = Active. FFFF = Input reading error.

## READING OUTPUTS

<b>Format</b>	O   U   T   S   n   <CR LF>
<b>Where</b>	n Output (1 / 2).
<b>Response</b>	O   U   T   S   n   v   v   v   v   <CR LF>
<b>Where</b>	n Output number. vvv Output status: 0000 = Not active. 0001 = Active. FFFF = Output reading error.

### PRESSING A KEY

Format	K	E	Y	P	x	x	<CR LF>
Where	xx		Key code.				
	00		▼				
	01		▲				
	02		▶				
	03		←				
	04		C				



To simulate pressing a key, you must send the KEYP and KEYR commands in succession. If more than 1.5 s pass after the KEYP command is sent, the transmitter will execute the function associated with prolonged pressing of the key.

Response	OK<CR LF> (or ERRxx).
----------	-----------------------

### RELEASING A KEY

Format	K	E	Y	R	<CR LF>
--------	---	---	---	---	---------

Response	OK<CR LF> (or ERRxx).
----------	-----------------------

### BRIDGE BETWEEN THE SERIAL PORTS

Format	B	R	I	D	G	E	1	<CR LF>
--------	---	---	---	---	---	---	---	---------

Response	OK<CR LF> (or ERRxx).
----------	-----------------------

### SCALE INFORMATION

Format	R	A	L	L	<CR LF>
--------	---	---	---	---	---------

Response	s	s	,	b	,	N	N	N	N	N	N	u	u	,	L	L	L	L	L	L	u	u	,
	Y	Y	T	T	T	T	T	T	u	u	,	S	S	S	,	A	A	A	,	C	C	C	C
	,	,	R	R	R	R	R	-	I	I	I	I	I	I	I	<CR LF>							

Where	Response	Description
	ss	UL = Underload. OL = Overload. ST = Stable weight. US = Unstable weight.
	b	Number of the active scale.
	NNNNNNuu	Net weight with unit of measurement.
	LLLLLuu	Gross weight with unit of measurement.
	YY	PT if a manual tare is present or “ ”.
	TTTTTuu	Tare with unit of measurement.
	SSS	Scale status: 000 = scale weighing. 001 = entering a numerical value. 002 = scale in technical menu.
	AAA	Counter keys pressed: 0001 = ▼ 0002 = ▲ 0003 = ▶ 0004 = ← 0170 = C
	CCCC	Code of last key pressed.
	RRRRR	Last rewrite number saved to Alibi memory.
	IIIIII	Last ID number saved to Alibi memory.

**READING OF MICROVOLTS**

<b>Format</b>	M	V	O	L
<b>Response</b>	Standard string<CR LF>.			

**READING OF CONVERTER POINTS**

<b>Format</b>	R	A	Z	F
<b>Response</b>	Standard string<CR LF>.			

**INITIALISING ALIBI MEMORY**

<b>Format</b>	A	L	D	L
<b>Response</b>	ALDLOK / ALDLNO <CR LF>			

**WEIGHT READING WITH DATE AND TIME**

<b>Format</b>	R	E	X	D
<b>Response</b>	Extended string<CR LF>.			

**READING A WEIGHING OPERATION IN THE ALIBI MEMORY**

<b>Format</b>	A	L	R	D	X	X	X	X	X	-	Y	Y	Y	Y	Y	Y	<CRLF>
<b>Response</b>	b	,	L	L	L	L	L	L	L	L	L	L	u	u	,		
	Y	Y	T	T	T	T	T	T	T	T	T	T	u	u	<CRLF>		
<b>Where</b>	b		Scale number.														
	LLLLLLLLLuu		Gross weight with unit of measurement.														
	YY		"PT if a manual tare is present or " ".														
	TTTTTTTTTuu		Tare with unit of measurement.														

**SAVING A WEIGHING OPERATION IN THE ALIBI MEMORY**

<b>Format</b>	P	I	D	<CRLF>																			
<b>Response</b>	P	I	D	S	T	,	b	,	L	L	L	L	L	L	L	L	L	u	u	,	Y	Y	
	T	T	T	T	T	T	T	T	T	T	u	u	,	X	X	X	X	X	-	Y	Y	Y	Y
	Y	Y	<CRLF>																				
<b>Where</b>	b		Scale number.																				
	LLLLLLLLLuu		Gross weight with unit of measurement.																				
	YY		"PT if a manual tare is present or " ".																				
	TTTTTTTTTuu		Tare with unit of measurement.																				
	XXXXXX		Rewrite number.																				
	YYYYYYY		ID number.																				

**i** The alibi memory commands are executed only if  $F_{un}LE = AL$  is 1.

In IND.CH mode, if the commands "ZERO", "TARE" and "TMAN" are followed by "X", the command is executed only on the indicated scale. For example:

<b>Format</b>	T	A	R	E	,	X	<CRLF>
<b>Where</b>	X		Scale: 0 = scale 1 1 = scale 2 2 = scale 3 3 = scale 4				
<b>Response</b>	OK<CR LF> (or ERRxx).						

<b>Format</b>	Z	E	R	O	,	X	<CRLF>
<b>Where</b>	X		Scale: 0 = scale 1 1 = scale 2 2 = scale 3 3 = scale 4				
<b>Response</b>	OK<CR LF> (or ERRxx).						

**📖** The fieldbus protocol is described in the respective manual.



# Modbus Protocol

## MODBUS REGISTERS FOR DATA READING (SINGLE SCALE)

Data	Register	DESCRIPTION
Gross Weight	30001	Gross weight value.
	30002	
Net Weight	30003	Net weight value.
	30004	
Input status register	30005	Bit 15 <sup>(msb)</sup> Active channel. Bit 14 <sup>(msb)</sup> Active channel. Bit 13 No function. Bit 12 No function. Bit 11 No function. Bit 10 No function. Bit 9 Input no. 2 status. Bit 8 <sup>(lsb)</sup> Input no. 1 status.
		Bit 7 <sup>(msb)</sup> Gross zero zone (0 = "outside zone 0"; 1 = "in zone 0"). Bit 6 <sup>(msb)</sup> Tare PT (1 = a preset tare is active). Bit 5 Tare (1 = a tare is active). Bit 4 Overload condition (0 = No; 1 = Overload). Bit 3 Underload condition (0 = No; 1 = Underload). Bit 2 Stability (0 = Unstable; 1 = Stable). Bit 1 Gross weight sign (0 = "+"; 1 = "-"). Bit 0 <sup>(lsb)</sup> Net weight sign (0 = "+"; 1 = "-").
Command status register	30006	Last command received.
		Bit 7 <sup>(msb)</sup> Last command result. Bit 6 <sup>(msb)</sup> Last command result. Bit 5 Last command result. Bit 4 Last command result. Bit 3 Processed command count. Bit 2 Processed command count. Bit 1 Processed command count. Bit 0 <sup>(lsb)</sup> Processed command count.
Output status register	30007	No function.
		Bit 7 <sup>(msb)</sup> No function. ... Bit 2 No function. Bit 1 Digital output 1 status (0 = OFF; 1 = ON). Bit 0 <sup>(lsb)</sup> Digital output 2 status (0 = OFF; 1 = ON).
$\mu$ V Channel 1	30111	$\mu$ V of channel 1.
$\mu$ V Channel 2	30112	$\mu$ V of channel 2.
$\mu$ V Channel 3	30113	$\mu$ V of channel 3.
$\mu$ V Channel 4	30114	$\mu$ V of channel 4.

 This manual contains the main registers for reading data / sending commands. Refer to the Modbus protocol manual for a complete list of available registers.

**MODBUS REGISTERS FOR DATA READING (MULTI-SCALE)**

Data	Register	DESCRIPTION
<i>Status register scale 1</i>	40202	Bit 15 <sub>(msb)</sub> Not used. Bit 14 Not used. Bit 13 Not used. Bit 12 Scale active (0 = "no"; 1 = "yes"). Bit 11 Decimals (00 = 0; 01 = 1; 10 = 2; 11 = 3) Bit 10 Bit 9 Unit of Measure (00 = "g"; 01 = "kg"; 10 = "t"; 11 = "lb"). Bit 8 <sub>(lsb)</sub>
		Bit 7 <sub>(msb)</sub> Preset tare (0 = "no"; 1 = "yes"). Bit 6 Active tare (0 = "no"; 1 = "yes"). Bit 5 Net weight polarity (0 = "+"; 1 = "-"). Bit 4 Gross zero zone (0 = "outside zone 0"; 1 = "in zone 0"). Bit 3 Overload condition (0 = No; 1 = overload). Bit 2 Underload condition (0 = No; 1 = underload). Bit 1 Stability (0 = "unstable"; 1 = "stable"). Bit 0 <sub>(lsb)</sub> Gross weight sign (0 = "+"; 1 = "-").
<i>Gross weight scale 1</i>	40203	Gross weight of scale 1.
	40204	
<i>Status register scale 2</i>	40205	As Status register scale 1.
<i>Gross weight scale 2</i>	40206	Gross weight of scale 2.
	40207	
<i>Status register scale 3</i>	40208	As Status register scale 1.
<i>Gross weight scale 3</i>	40209	Gross weight of scale 3.
	40210	
<i>Status register scale 4</i>	40211	As Status register scale 1.
<i>Gross weight scale 4</i>	40212	Gross weight of scale 4.
	40213	
<i>Net weight scale 1</i>	40214	Net weight of scale 1.
	40215	
<i>Net weight scale 2</i>	40216	Net weight of scale 2.
	40217	
<i>Net weight scale 3</i>	40218	Net weight of scale 3.
	40219	
<i>Net weight scale 4</i>	40220	Net weight of scale 4.
	40221	



This manual contains the main registers for reading data / sending commands. Refer to the Modbus protocol manual for a complete list of available registers.

## MODBUS REGISTERS FOR SENDING COMMANDS

Data	Register	DESCRIPTION																		
<i>Command</i>	40001	Main commands available:																		
		<table border="1"> <thead> <tr> <th>Value</th> <th>Command</th> </tr> </thead> <tbody> <tr> <td>00 Hex</td> <td>No command</td> </tr> <tr> <td>01 Hex</td> <td>Zero</td> </tr> <tr> <td>02 Hex</td> <td>Tare</td> </tr> <tr> <td>03 Hex</td> <td>Predetermined tare</td> </tr> <tr> <td>0A Hex</td> <td>Setting setpoint 1</td> </tr> <tr> <td>0B Hex</td> <td>Setting setpoint 2</td> </tr> <tr> <td>19 Hex</td> <td>Setting digital outputs</td> </tr> <tr> <td>22 Hex</td> <td>Rebooting the transmitter</td> </tr> </tbody> </table>	Value	Command	00 Hex	No command	01 Hex	Zero	02 Hex	Tare	03 Hex	Predetermined tare	0A Hex	Setting setpoint 1	0B Hex	Setting setpoint 2	19 Hex	Setting digital outputs	22 Hex	Rebooting the transmitter
		Value	Command																	
		00 Hex	No command																	
		01 Hex	Zero																	
		02 Hex	Tare																	
		03 Hex	Predetermined tare																	
		0A Hex	Setting setpoint 1																	
		0B Hex	Setting setpoint 2																	
19 Hex	Setting digital outputs																			
22 Hex	Rebooting the transmitter																			
<i>Parameter 1</i>	40002	First command parameter. The parameter is always expressed as an absolute value (no decimal / sign).																		
	40003																			
<i>Parameter 2</i>	40004	Second command parameter. The parameter is always expressed as an absolute value (no decimal / sign).																		
	40005																			

### EXAMPLE 1

To reset the weight on the scale:

2. Set the command in byte 2

Byte	Value
1	00 Hex
2	01 Hex

### EXAMPLE 2

To set a predetermined tare of 1000kg:

1. Set the value in parameter 1 (byte 3, 4, 5, 6)
2. Set the command in byte 2

Byte	Value
1	00 Hex
2	03 Hex
3 <sub>(MSB)</sub>	00 Hex
4	00 Hex
5	03 Hex
6 <sub>(LSB)</sub>	E8 Hex



This manual contains the main registers for reading data / sending commands.  
Refer to the Modbus protocol manual for a complete list of available registers.

# Diagnostics

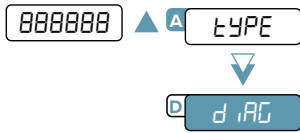

1 PrG .UER

Display of firmware release (e.g. 01.05.00).

2 PRnuF .d

Display of firmware libraries (for use by the manufacturer).

3 d iU . int

Display of calibration internal divisions.

4 AdC . uU

Display of the  $\mu V$  related to the weight on the scale.

Use the ▲ and ▼ keys to display the different channels (in dEP .Ch mode the sum is also visible).

For correct operation, the value of the  $\mu V$  of each channel must be less than 30000 with a weight equal to the maximum capacity. This value must be stable, and increase if a load is applied to the cell.

5 AdC . Pnt

Display of the A/D points of the converter related to the weight on the scale.

Use the ▲ and ▼ keys to display the different channels (in dEP .Ch mode the sum is also visible).

For correct operation, the value of A/D points must be stable, and increase if a load is applied to the cell.

6 WE iGht

Display of the weight on the scale.

Use the ▲ and ▼ keys to display the different channels.

7 CAL . Pts

Display of calibration points with corresponding A/D point values.

Use the ▲ and ▼ keys to display the different calibration points.

Press the ► key to display the different channels.

8 d iSPLA

Activation of all display segments and indicators.

9 KEyb

The code of last key pressed is shown on the display:

▼	8001
▲	8002
►	8003
◀	8004
C	80AA

Press the same key 3 consecutive times to exit.

10 SEr

Bridge between serial ports (for manufacturer's use).



Complete menu  
on pages 21 - 22

#### MENU ACCESS:

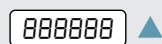

Press the ▲ key during the start-up procedure.

#### SAVING THE PARAMETERS:

Press the C key several times, until the display shows SAUEP. Press the ◀ key to confirm.

11 outPut

Activation of the output shown on the display (rEL . 1 / rEL . 2).  
Use the ▲ and ▼ keys to activate the two outputs.

12 inPutS

Checking the status of the inputs:  
value 0 indicates that the input is disabled, value 1 indicates that the input is enabled.  
Use the ▲ and ▼ keys to display the two inputs.

13 An.out

Analog output test.  
Use the ▲, ▼, ► keys to enter the D/A point value of the analog output.  
Press the ◀ key to confirm and update the V / mA value of the analog output.

14 SEr . num

Display of transmitter serial number.

15 S . rAd io

Radio channel display and setting.

## Unbalancing

The instrument has an active unbalance function as standard that signals if the load is unevenly distributed, compared to the stored condition.

Imbalance occurs when the load distribution percentage value on a cell deviates by at least 10% for more than 3 seconds.  
It is possible to change these value with the following parameters:

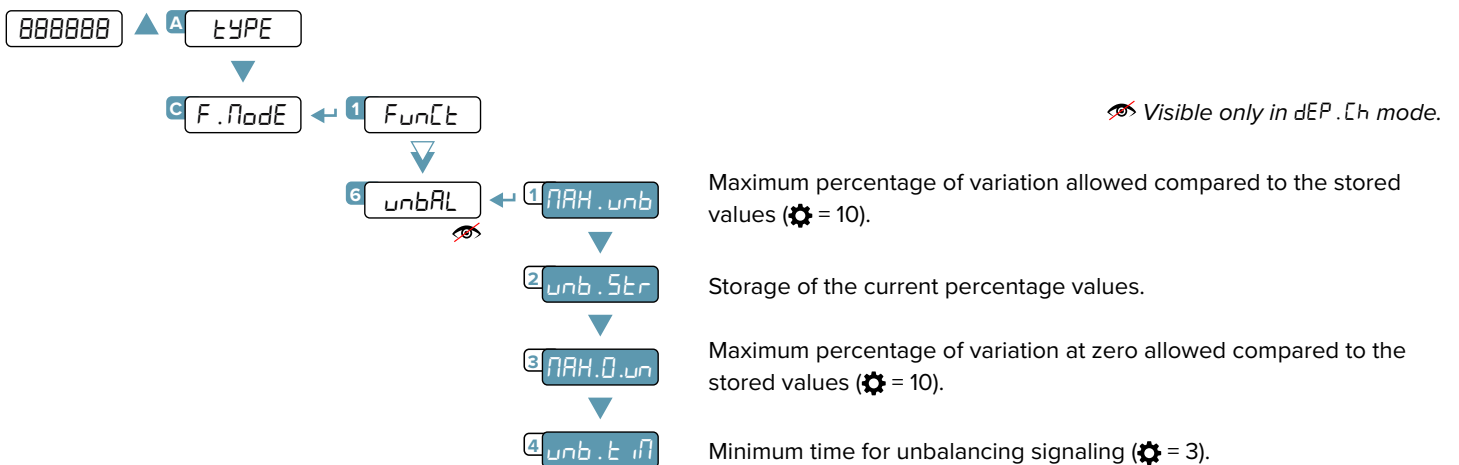

### LEGEND:

- Indicates repeated pressing of the ▼ key.
- Parameter visible only under certain conditions.
- Parameter or menu subject to approval.
- Default value of the parameter.

Example:

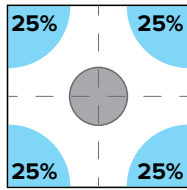

Condition stored

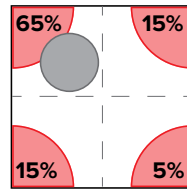
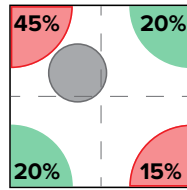
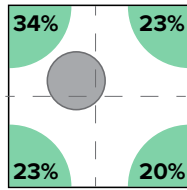

The unbalance condition is signalled via Modbus / Fieldbus or a digital output ( $F_{unc} = 31.unb$ ).



This function is only available if  $EHCL.Ch = none$ .  
Use this function only in systems where the load is evenly distributed.

## Programming the Setpoints

In weighing mode, if the output functions ( $1 Gross / 2 net$ ) have been set correctly, pressing  $\leftarrow$  for 3 seconds will enter the setpoint programming menu:

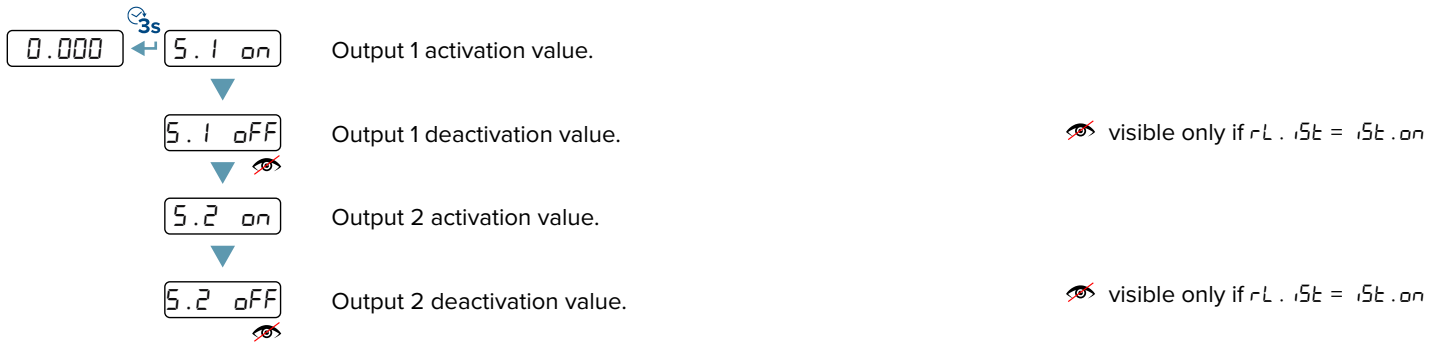

Once you have entered the desired values, press  $\square$ . The display shows "StarE" and returns to weighing mode.



Complete menu  
on pages 21 - 22

### MENU ACCESS:

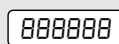

Press the  $\blacktriangle$  key during the start-up procedure.

### SAVING THE PARAMETERS:

Press the  $\square$  key several times, until the display shows **SAVEP**. Press the  $\leftarrow$  key to confirm.



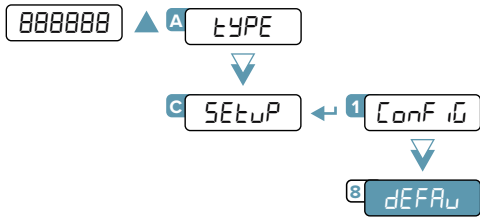

# Restoring Factory Settings



The transmitter is initialized and the default parameters (indicated by the ⚙️ symbol) are activated. Pressing ← the display shows “dFLt?” confirm further with ← or exit by pressing another key.

The actual activation of the default parameters is performed by saving the settings (SAVE?) while exiting the menu.

## LEGEND:

-  Indicates repeated pressing of the ▼ key.
-  Parameter visible only under certain conditions.
-  Parameter or menu subject to approval.
-  Default value of the parameter.

Alarm	Description		
<i>P r E C</i>	Displayed if you try to calibrate a point without first confirming the number of calibration points ( <i>n t P</i> ).		
<i>E r . n o t</i>	Calibration error: unstable weight during point acquisition.		
<i>E r P n t</i>	Calibration error: during the acquisition of a calibration point a NULL value was read from the converter.		
<i>E r r . H . 1</i>	Error that occurs if the capacity of channel <i>H</i> is not set, or there is an error in the calibration parameters of channel <i>H</i> , where <i>H</i> indicates the number of the channel to which the error refers.		
<i>a U E r H</i>	Error that occurs if the capacity of channel <i>H</i> is not set, or there is an error in the calibration parameters of channel <i>H</i> , where <i>H</i> indicates the number of the channel to which the error refers.		
<i>E r 11</i>	Calibration error: a sample weight that is too low was used; it is recommended to use a weight of at least half the scale's capacity.		
<i>E r 12</i>	Calibration error: The acquired calibration point ( <i>t P 1 / t P 2 / t P 3</i> ) is equal to the zero point ( <i>t P 0</i> ).		
<i>E r 37</i>	Scale to be calibrated (we recommend resetting the transmitter to the factory default "dEFAU" settings before proceeding).		
<i>E r 39</i>	Scale to be calibrated (we recommend resetting the transmitter to the factory default "dEFAU" settings before proceeding).		
<i>E . E r . -36</i>	Negative internal points were calculated during calibration: <ul style="list-style-type: none"> <li>the calibration point is below the zero point;</li> <li>the signal is negative (check the connections).</li> </ul>		
<i>E . E r . -37</i>	Internal points below the minimum value were calculated during calibration: <ul style="list-style-type: none"> <li>the calibration point is equal to the zero point;</li> <li>too high a capacity has been set with respect to the division.</li> </ul>		
<i>h B . E r r</i>	Hardware error: software not compatible with the installed hardware.		
<i>A L . E r r</i>	Displayed when the alibi memory is enabled and the transmitter does not detect the presence of the card when the power is turned on. The <i>E o n U</i> function is set automatically, but not saved in the setup environment.		
<i>b u S Y</i>	Printing in progress (printer serial port busy) or transmitter waiting to transmit a print to PC.		
<i>u n S t A b</i>	You are trying to print with an unstable weight.		
<i>u n . a U E r</i>	You are trying to print with the weight in underload / overload.		
-----	The weight is overloaded (9 divisions over the maximum capacity).		
-----	The weight is underloaded. <table border="1" style="margin-left: 20px;"> <tr> <td>Restricted transmitter: -9 divisions.</td> </tr> <tr> <td>Non-restricted transmitter: -100 divisions.</td> </tr> </table>	Restricted transmitter: -9 divisions.	Non-restricted transmitter: -100 divisions.
Restricted transmitter: -9 divisions.			
Non-restricted transmitter: -100 divisions.			
<i>G r o S . E r</i>	You are trying to print with a non-positive gross weight (less than or equal to zero).		
<i>n E r . E r r</i>	You are trying to print with a non-positive net weight (less than or equal to zero).		
<i>n o . 0 . u n S</i>	Weight not passed by net 0 or instability.		
<i>E o n U</i>	You are trying to print while the transmitter is converting the unit of measurement.		
<i>E r r . C L K</i>	Communication problems with the clock card of the transmitter.		
<i>E E L . E r r</i>	Signal anomaly: check the connection of the cells.		
<i>E r . E E L . 1</i> ... <i>E r . E E L . 4</i>	Signal anomaly: check the connection of the cell indicated.		
<i>E H C L . C h</i>	You are trying to perform a calibration/point acquisition with an excluded channel. Check the <i>E H C L . C h</i> parameter in the quick menu (ref. Quick start guide).		



Complete menu  
on pages 21 - 22

#### MENU ACCESS:

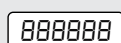

Press the key during the start-up procedure.

#### SAVING THE PARAMETERS:

Press the key several times, until the display shows 5RAUEP. Press the key to confirm.











© Rice Lake Weighing Systems    Content subject to change without notice.

230 W. Coleman St. • Rice Lake, WI 54868 • USA    USA: 800-472-6703 • International: +1-715-234-9171