

# SCT-4X-PROFINET

---

## Quick Start Guide



# 1. Electrical Schematic

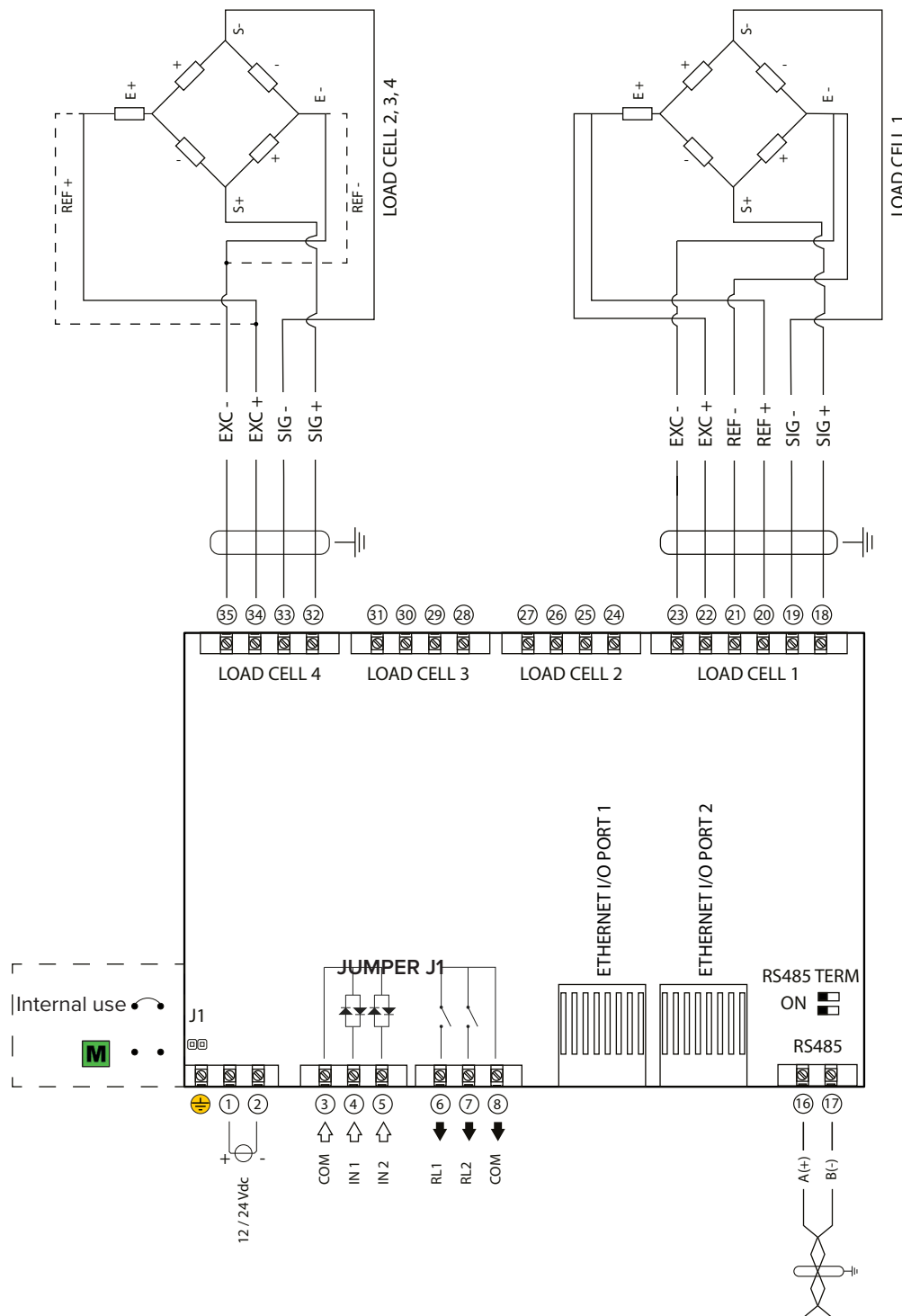

⚠ In LOAD CELL 2, 3, 4 connect:  
SEN + to EXC +  
SEN - to EXC -

⚠ The single SENSE circuit  
compensates all 4 load cells.

⚠ Load cells excitation: 5 V.  
Load cells output: 6 mV/V max.

⚠ For UL approved models:  
equipment to be powered by  
12 to 24 Vdc LPS or Class 2  
power source.

⚠ CONSUMPTION:  
4.5 W max.

⚠ INPUT: 12 to 48 Vdc  
OUTPUT: 48Vac or 60Vdc, 0.5  
A max



Manuals are available from Rice Lake Weighing Systems at [www.ricelake.com/manuals](http://www.ricelake.com/manuals)  
Warranty information is available at [www.ricelake.com/warranties](http://www.ricelake.com/warranties)

## 2. Key Functions

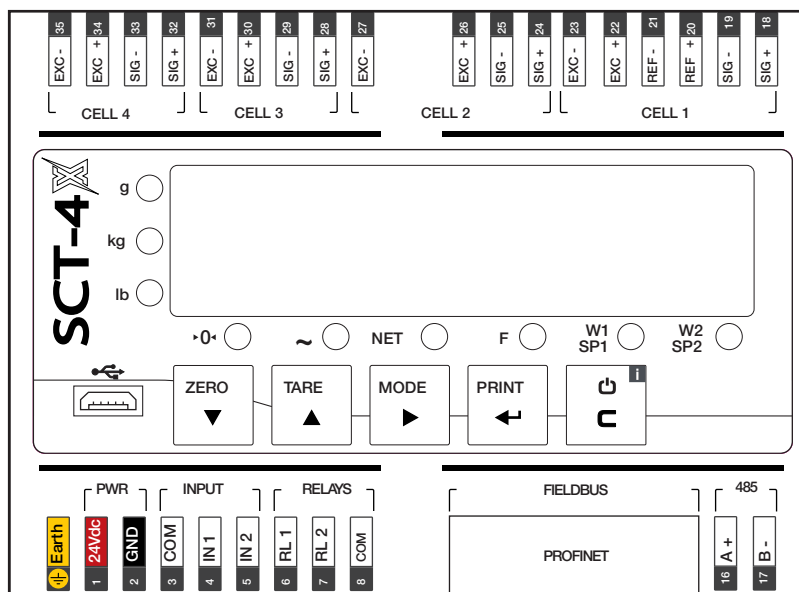

Configuration menu	
▼	Decreases digit / Scrolls down.
▲	Increases digit / Scrolls up.
▶	Enters the setup. Selects digit to modify.
←	Enters a step / Confirms.
C	Clears / Exits a step (no save).

Weighing mode	
▼	Clears the displayed gross weight.
▲	Short press: executes semiautomatic tare. Long press: allows to enter known tare.
▶	Long press: switches between scales (only in Mode 2 "ind.[h]").
←	Short press: executes data transmission on the printer serial port. Long press: Setpoint configuration.
C	ON/Standby of the instrument.

## 3. Indicator Light Descriptions

0	Weight on zero.
~	Unstable weight.
NET	A tare is active.
F	A function is active.
W1 SP1	Digital output 1 is active.
W2 SP2	Digital output 2 is active.

## 4. Configuration Menu

1. Reboot the weight transmitter
2. Press the ► key when display shows the *BBBBBB* message:

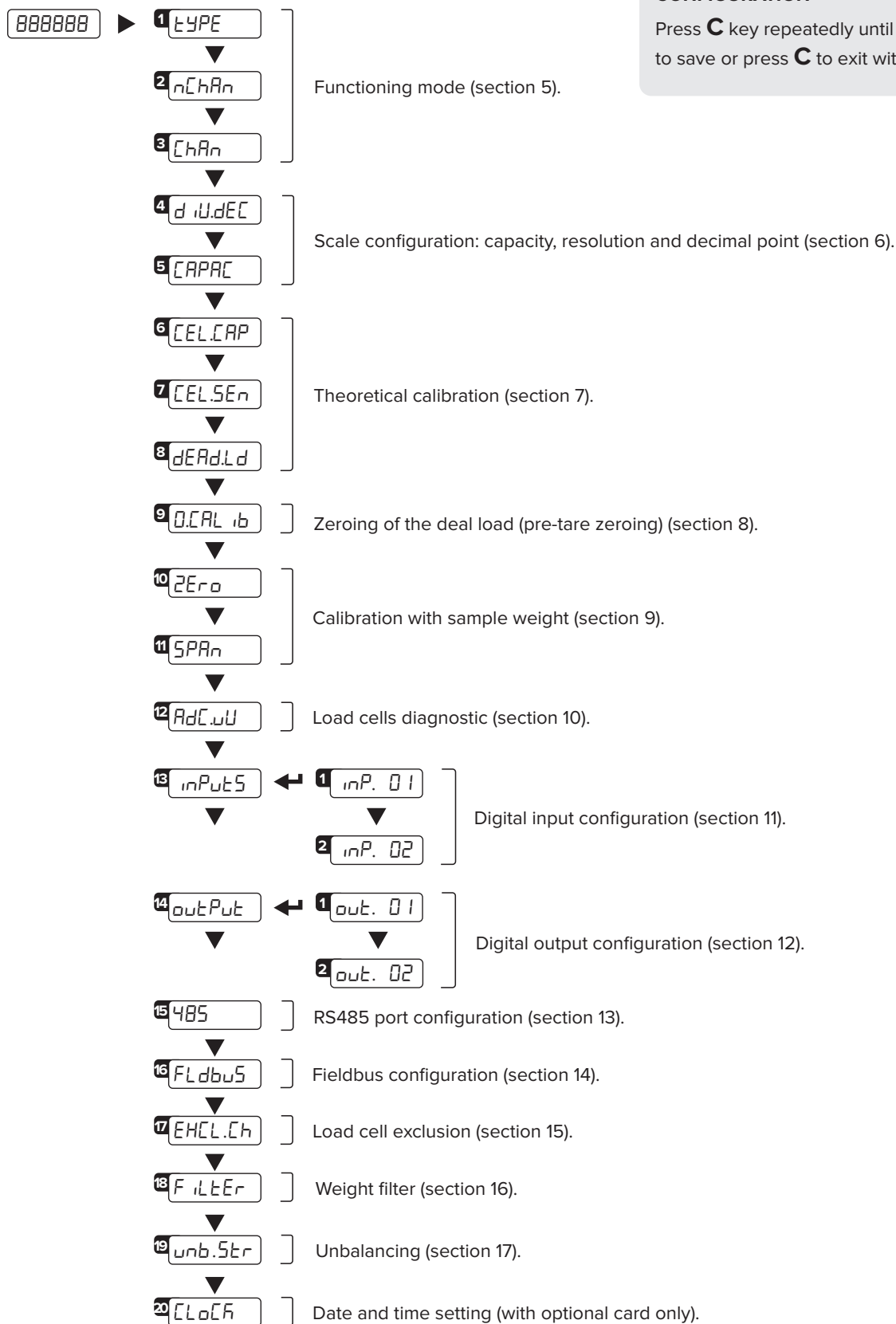

### HOW TO EXIT THE MENU AND SAVE YOUR CONFIGURATION

Press **C** key repeatedly until *SAVEP* appears; press **←** to save or press **C** to exit without saving.

## 5. Function Mode

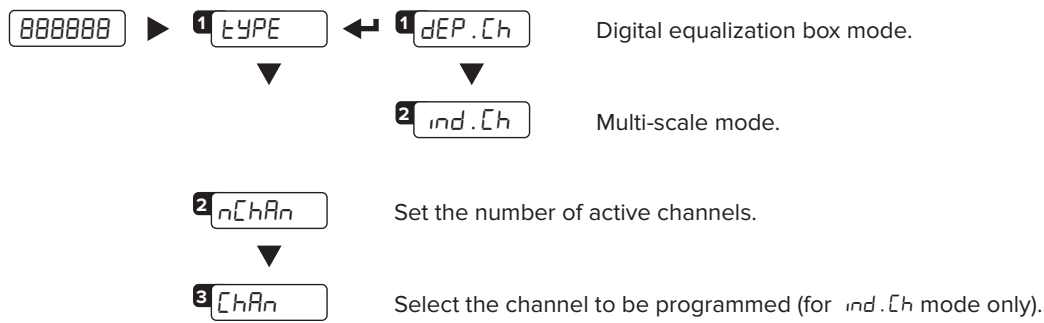

### MODE 1 “DEP.CH”

Allows to connect directly the load cells, equalize them (if necessary) and transmit each load cell data and the total weight through Fieldbus.

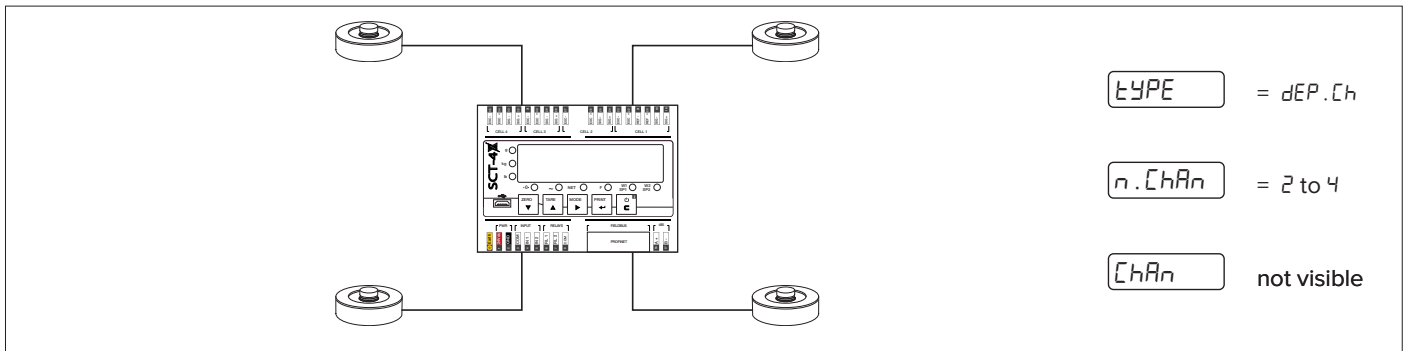

### MODE 2 “IND.CH”

Allows to manage up to 4 independent scales and transmit all data of each scale through Fieldbus.

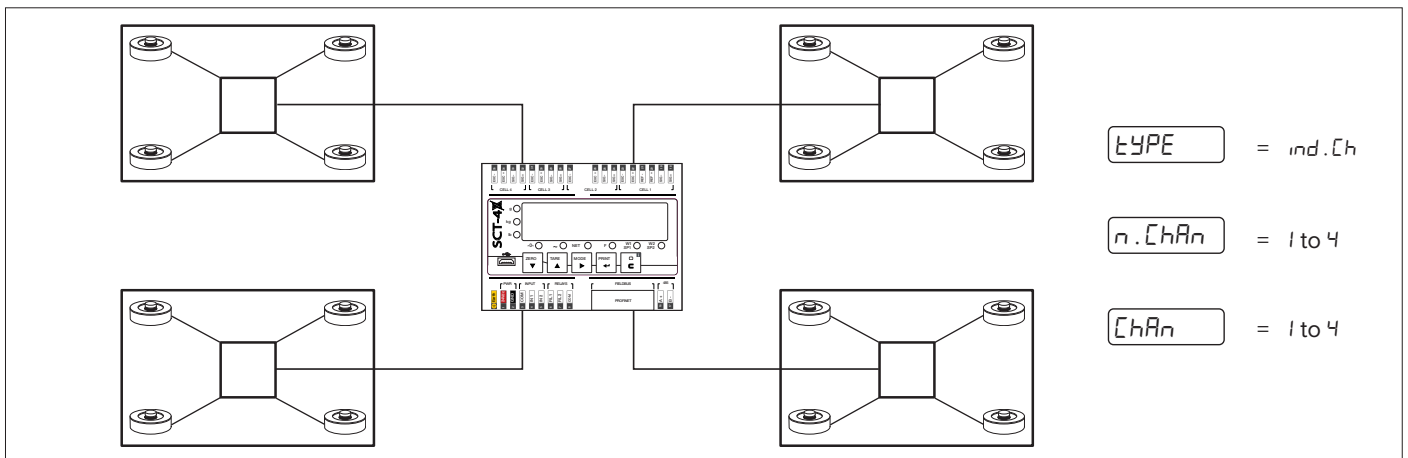

## 6. Maximum Scale Capacity, Increment and Decimal Point Settings

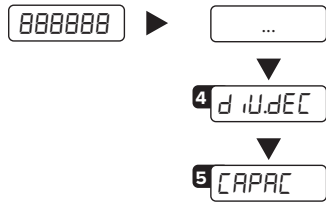

Set the decimal point position and the minimum scale increment\*<sup>1</sup>  
 (0.001 - 0.002 - 0.005 - 0.01 - 0.02 - 0.05 - 0.1 - 0.2 - 0.5 - 1 - 2 - 5 - 10 - 20 - 50).

Set the maximum scale capacity\*<sup>2</sup> (max 999999).

Examples:

For a 60000 lb scale, with 2 lb increment:  
 d.u.dEC = 2  
 CAPAC = 60000

For a 10000 g scale, with 0.1 g increment:  
 d.u.dEC = 0.1  
 CAPAC = 10000.0

For a 3000 lb scale, with 0.05 lb increment:  
 d.u.dEC = 0.05  
 CAPAC = 3000.00

\*<sup>1</sup> Increment = the amount that the scale will increment by as weight is added or removed.

\*<sup>2</sup> Maximum capacity = the maximum weight that can be measured using the scale you are creating.

## 7. Theoretical Calibration

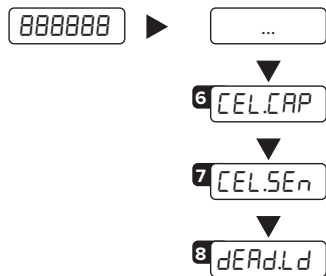

Set the total load cells capacity (up to 999999).

Set the load cells sensitivity (up to 999999). \*

Dead load weight (from -9999.9 to 99999.9).

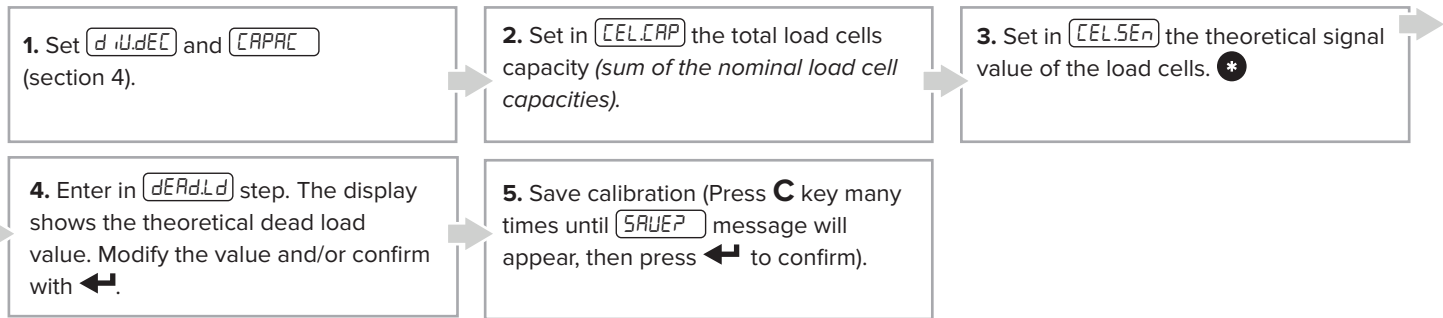

**MODE 1 "DEP.CH"**

Insert in **CELSEN** parameter, the load cells sensitivity sum value:  
 (mV/V cell1) + (mV/V cell2) + (mV/V cell3) + (mV/V cell4)

**MODE 2 "IND.CH"**

For each scale to calibrate, insert in **CELSEN** parameter the average sensitivity value of the load cells:  

$$\frac{(mV/V \text{ cell1}) + (mV/V \text{ cell2}) + \dots + (mV/V \text{ cell}n)}{n}$$

## 8. Zeroing Mechanic Tare (pre-tare zeroing)

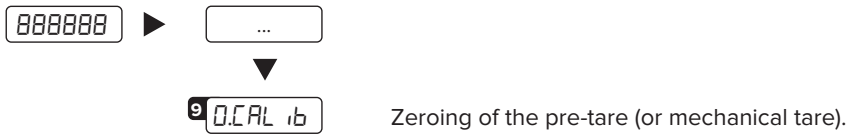

This functionality allows to zero the weigh of the scale structure (e.g. empty silo, conveyor, etc.) without changing the calibration in memory.

## 9. Calibration with Sample Weight

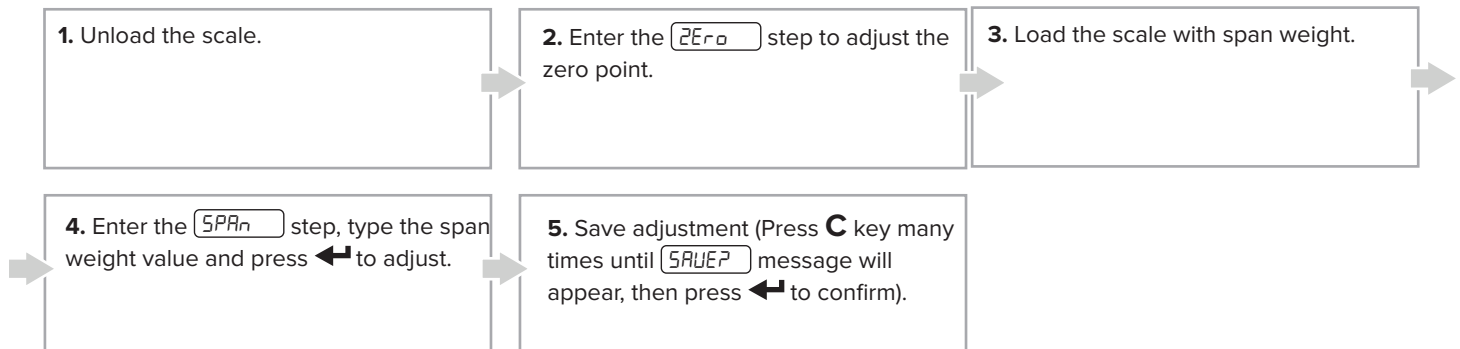
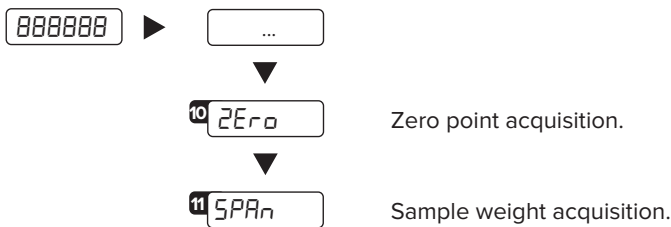

## 10. Load Cell Diagnostics ( $\mu V/V$ )

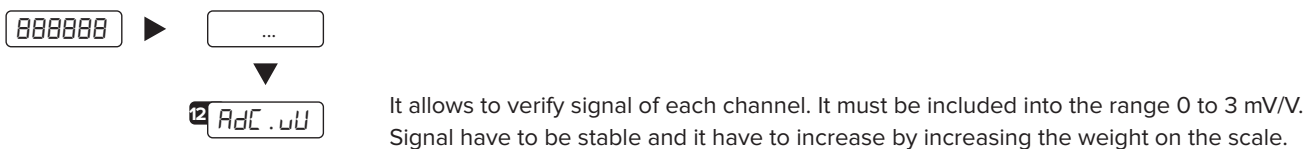

With more channels connected, it's possible to scroll between channels with keys ▼ and ▲.

## 11. Inputs Settings

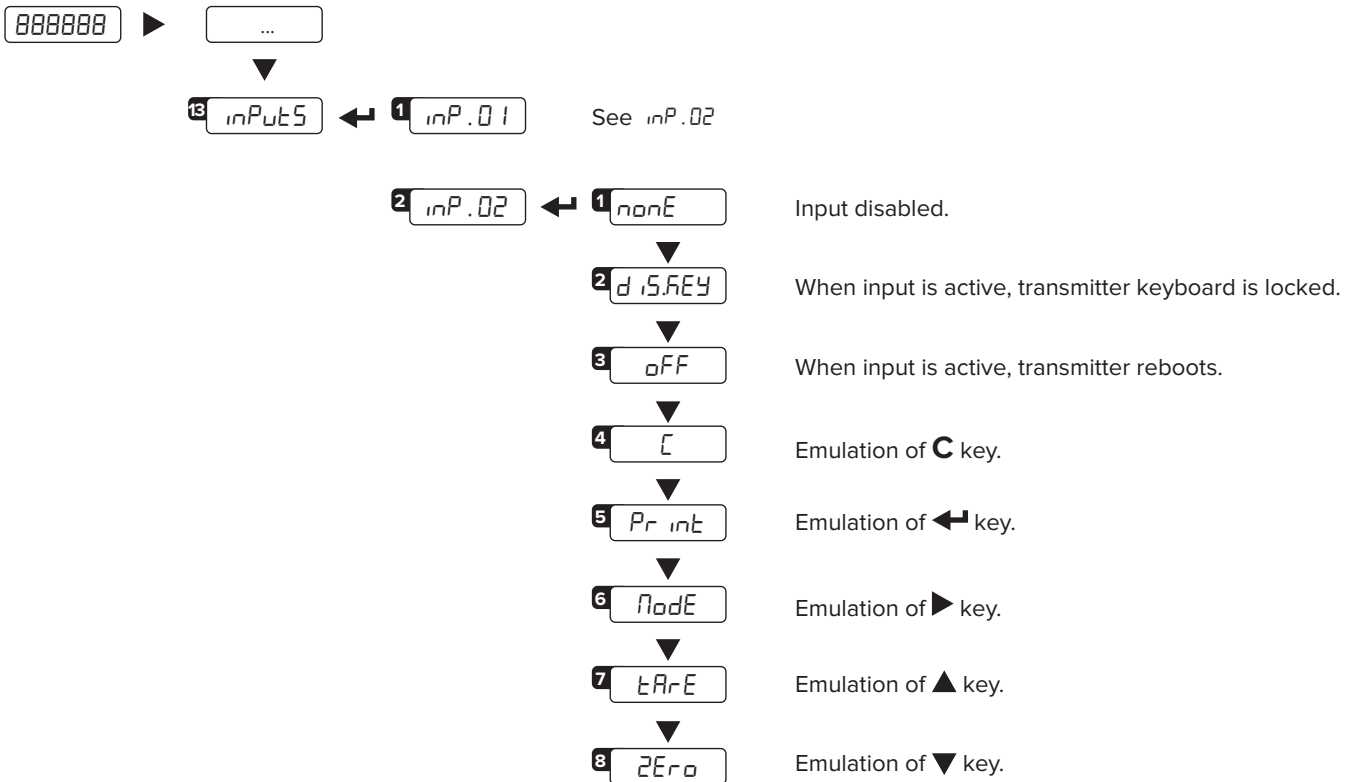

## 12. Outputs Settings

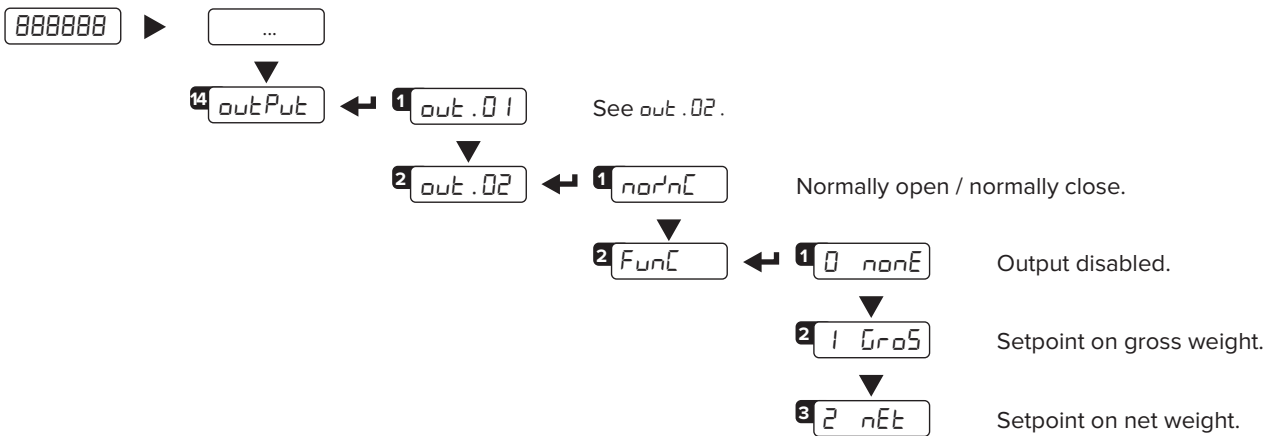

### 12.1 HOW TO PROGRAM SETPOINTS

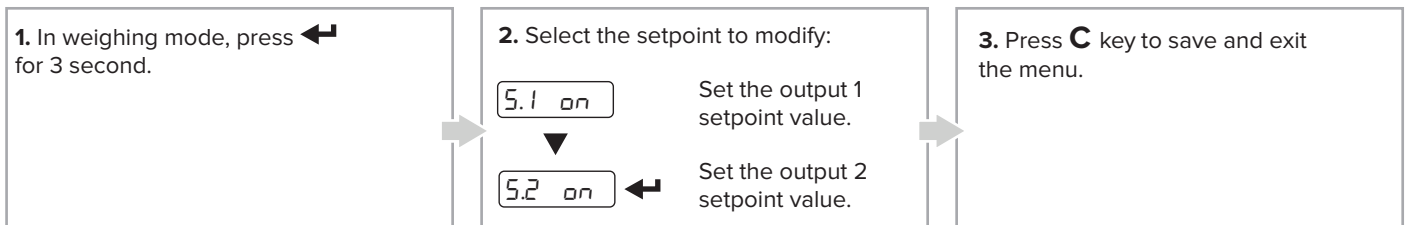



### 13. RS485 Port

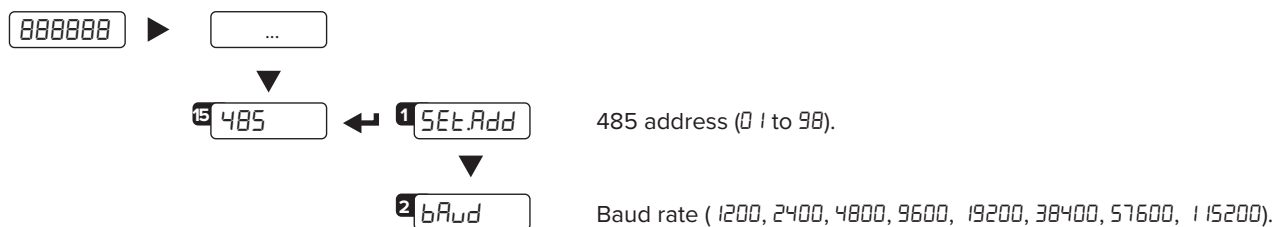

**i** The RS485 port is configured by default to communicate in Modbus RTU.

### 14. Fieldbus Settings

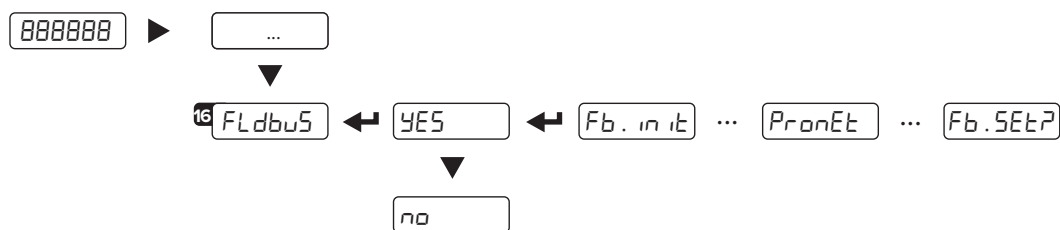

Set the IP address:

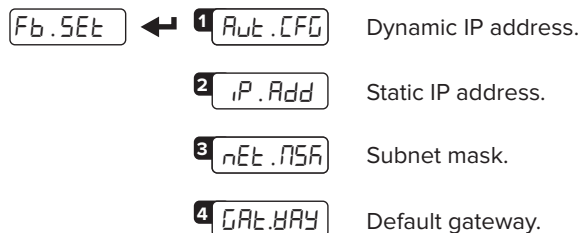

**i** The name of the Profinet node to use in the project linked to the network master node is provided by **dini-<IP4>**, <IP4> being the last Byte of the IP address incorporated in the device configuration, also when dynamic IP is used. Ex. IP - 192.168.1.10, the node name will be **dini-010**.

## 15. Load Cell Exclusion (for dependent channel systems)

If a load cell is broken, it's possible to temporarily exclude the channel where it is connected and continue to weigh, pending replacement.

**⚠ WARNING:** this operation reduces the accuracy of the weighing system. We recommend use for liquid weighing or in applications where the load is evenly distributed.

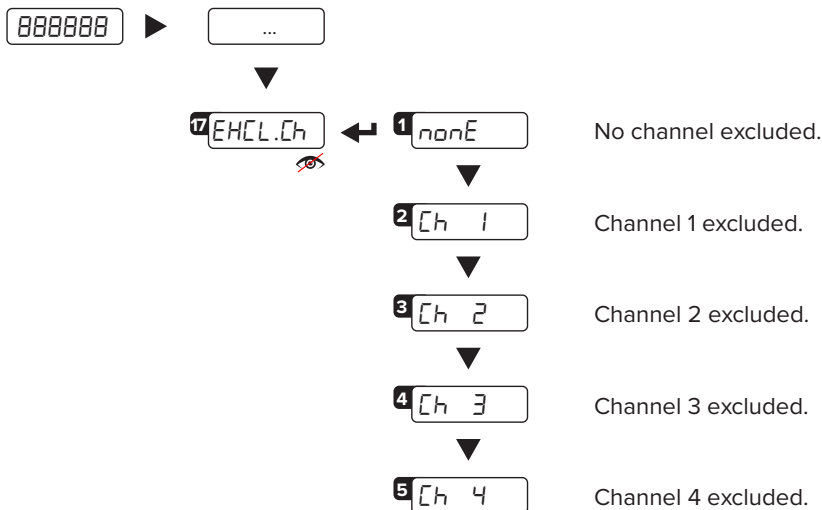

Visible only in dEP.Ch mode.

## 16. Weight filter

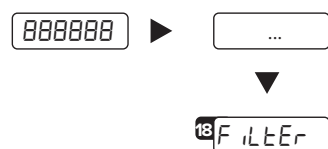

The active weight filter is displayed, alternating with the weight value.  
Press ▲ and ▼ keys to scroll through the available filters (from slowest to fastest, F1 to F10).

## 17. Unbalancing

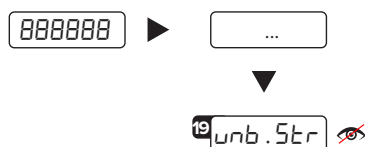

Visible only in dEP.Ch mode.

The instrument has an active unbalance function as standard that signals if the load is unevenly distributed, compared to the condition saved via step Str.unb.

Imbalance occurs when the load distribution percentage value on a cell deviates by at least 10% for more than 3 seconds.

Example:

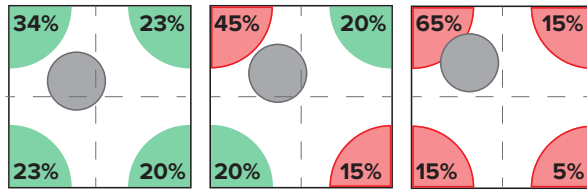
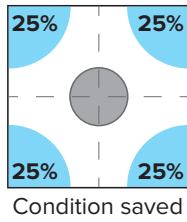

The unbalance condition is signaled via Modbus / Fieldbus or a digital output (refer to the complete manual to set the output).

**i** This function is only available if  $EHCL.Ch = none$ .  
Use this function only in systems where the load is evenly distributed.

## 18. Programming Errors

MESSAGE	DESCRIPTION	SOLUTION
<i>PrEC.</i>	Calibration error	First calibrate the zero point ( <i>ZERO</i> ), then proceed with sample weight acquisition ( <i>SPRN</i> ) (section 9).
<i>Err.Pnt</i>	Calibration error	Check the connection of the load cell. Verify the load cell signal is stable, valid and greater than the previously acquired point.
<i>Er 11</i>	Calibration error	Increase the calibration weight.
<i>Er 12</i>	Calibration error	Check the signal from the load cell increases when weight is incremented on the scale.
<i>Er 37</i>	Calibration error	Repeat calibration and verify capacity and division have been correctly set.
<i>Er 39</i>	Instrument not configured	Transmitter needs to be configured.
<i>CEr. 36</i>	Calibration error	Verify the signal from the load cell is not negative.
<i>CEr. 37</i>	Calibration error	Verify the signal from the load cell is not negative.
<i>Err.Pnt</i>	Weight unstable	Check in <i>AdC.WU</i> parameter that the signal is stable. If the connection of the cells is with 4 wires, check that the sense jumpers are inserted.
<i>AdC.Err</i>	A/D converter error	Converter failure. Reboot the instrument.
<i>CEL.Err</i>	Global load cell error	Signal anomaly: check the load cells connection.
<i>Er.CEL.1</i> ... <i>Er.CEL.4</i>	Load cell error	Signal anomaly: check the indicated load cell connection.

## 19. Profinet

### 19.1 PROFINET REGISTERS - *dEP.Ch / ind.ch* (1 SCALE)

Data	Byte	DESCRIPTION															
<i>Gross weight</i>	0 <sub>(MSB)</sub>	Bytes 1, 2, 3 and 4 contain the Gross Weight value.															
	1																
	2																
	3 <sub>(LSB)</sub>																
<i>Net weight</i>	4 <sub>(MSB)</sub>	Bytes 5, 6, 7 and 8 contain the Net Weight value.															
	5																
	6																
	7 <sub>(LSB)</sub>																
<i>Input status register</i>	8 <sub>(MSB)</sub>	Bit 15 <sub>(msb)</sub> Active channel. Bit 14 Active channel. Bit 13 No function. Bit 12 No function. Bit 11 No function. Bit 10 No function. Bit 9 Status of input n. 2. Bit 8 <sub>(lsb)</sub> Status of input n. 1. <table border="1" data-bbox="1101 674 1433 867" style="float: right; margin-top: 10px;"> <thead> <tr> <th>Bit 15</th> <th>Bit 14</th> <th>Active Channel</th> </tr> </thead> <tbody> <tr> <td>0</td> <td>0</td> <td>Channel 1</td> </tr> <tr> <td>0</td> <td>1</td> <td>Channel 2</td> </tr> <tr> <td>1</td> <td>0</td> <td>Channel 3</td> </tr> <tr> <td>1</td> <td>1</td> <td>Channel 4</td> </tr> </tbody> </table>	Bit 15	Bit 14	Active Channel	0	0	Channel 1	0	1	Channel 2	1	0	Channel 3	1	1	Channel 4
	Bit 15	Bit 14	Active Channel														
0	0	Channel 1															
0	1	Channel 2															
1	0	Channel 3															
1	1	Channel 4															
9 <sub>(LSB)</sub>	Bit 7 <sub>(msb)</sub> 1 = Scale unloaded (gross weight = 0). Bit 6 Tare PT (1 = PT tare is active). Bit 5 Tare (1 = Tare is active). Bit 4 Overload condition (0 = No; 1 = Overload). Bit 3 Underload condition (0 = No; 1 = Underload). Bit 2 Weight Stability (0 = Unstable; 1 = Stable). Bit 1 Gross Weight Polarity (0 = "+"; 1 = "-"). Bit 0 <sub>(lsb)</sub> Net Weight Polarity (0 = "+"; 1 = "-").																
<i>Command status register</i>	10 <sub>(MSB)</sub>	Last received command.															
	11 <sub>(LSB)</sub>	Bit 7 <sub>(msb)</sub> Last command result. Bit 6 Last command result. Bit 5 Last command result. Bit 4 Last command result. Bit 3 Counting of processed commands. Bit 2 Counting of processed commands. Bit 1 Counting of processed commands. Bit 0 <sub>(lsb)</sub> Counting of processed commands.															
<i>Output status register</i>	12 <sub>(MSB)</sub>	No Function.															
	13 <sub>(LSB)</sub>	Bit 7 <sub>(msb)</sub> No function. ... Bit 2 No function. Bit 1 Digital output 2 status (0 = OFF; 1 = ON). Bit 0 <sub>(lsb)</sub> Digital output 1 status (0 = OFF; 1 = ON).															
<i>Selected page</i>	14 <sub>(MSB)</sub>	Shows the value of the selected page (3001).															
	15 <sub>(LSB)</sub>																
<i>μV Channel 1</i>	16 <sub>(MSB)</sub>	Bytes 16 and 17 contain the μV value of the channel 1.															
	17 <sub>(LSB)</sub>																
<i>μV Channel 2</i>	18 <sub>(MSB)</sub>	Bytes 18 and 19 contain the μV value of the channel 2.															
	19 <sub>(LSB)</sub>																
<i>μV Channel 3</i>	20 <sub>(MSB)</sub>	Bytes 20 and 21 contain the μV value of the channel 3.															
	21 <sub>(LSB)</sub>																
<i>μV Channel 4</i>	22 <sub>(MSB)</sub>	Bytes 22 and 23 contain the μV value of the channel 4.															
	23 <sub>(LSB)</sub>																

19.2 PROFINET REGISTERS - *ind.ch* (4 SCALES)

Data	Byte	DESCRIPTION	
<i>Status register scale 1</i>	0 <sub>(MSB)</sub>	Bit 15 <sub>(msb)</sub> Bit 14 Bit 13 Bit 12 Bit 11 Bit 10 Bit 9 Bit 8 <sub>(lsb)</sub>	Not used. Not used. Not used. Scale active (0 = "no"; 1 = "yes"). Decimals (00 = 0; 01 = 1; 10 = 2; 11 = 3) Unit of Measure (00 = "g"; 01 = "kg"; 10 = "t"; 11 = "lb").
	1 <sub>(LSB)</sub>	Bit 7 <sub>(msb)</sub> Bit 6 Bit 5 Bit 4 Bit 3 Bit 2 Bit 1 Bit 0 <sub>(lsb)</sub>	Tare PT (1 = PT tare is active). Tare (1 = Tare is active). Net Weight Polarity (0 = "+"; 1 = "-"). 1 = Scale unloaded (gross weight = 0). Overload condition (0 = No; 1 = overload). Underload condition (0 = No; 1 = underload). Stability (0 = "unstable"; 1 = "stable"). Gross Weight Polarity (0 = "+"; 1 = "-").
<i>Status register scale 2</i>	2 <sub>(MSB)</sub>	Same as Status register scale 1.	
	3 <sub>(LSB)</sub>		
<i>Status register scale 3</i>	4 <sub>(MSB)</sub>	Same as Status register scale 1.	
	5 <sub>(LSB)</sub>		
<i>Status register scale 4</i>	6 <sub>(MSB)</sub>	Same as Status register scale 1.	
	7 <sub>(LSB)</sub>		
<i>Input status register</i>	8 <sub>(MSB)</sub>	Bit 15 <sub>(msb)</sub> Bit 14 Bit 13 Bit 12 Bit 11 Bit 10 Bit 9 Bit 8 <sub>(lsb)</sub>	Active channel. Active channel. No function. No function. No function. No function. Status of input n. 2. Status of input n. 1.
	9 <sub>(LSB)</sub>	No function.	
<i>Command status register</i>	10	Same as Command status register page 10.	
	11 <sub>(LSB)</sub>		
<i>Output status register</i>	12 <sub>(MSB)</sub>	Same as Output status register page 10.	
	13		
<i>Selected page</i>	14	Shows the value of the selected page (2000).	
	15 <sub>(LSB)</sub>		
<i>Gross weight scales 1, 2, 3 and 4</i>	16, 20, 24, 28 <sub>(MSB)</sub>	Bytes 16, 17, 18 and 19 contain the Gross Weight of scale 1.	
	17, 20, 24, 29	Bytes 20, 21, 22 and 23 contain the Gross Weight of scale 2.	
	18, 22, 26, 30	Bytes 24, 25, 26 and 27 contain the Gross Weight of scale 3.	
	19, 23, 27, 31 <sub>(LSB)</sub>	Bytes 28, 29, 30 and 31 contain the Gross Weight of scale 4.	

Bit 15	Bit 14	Active Channel
0	0	Channel 1
0	1	Channel 2
1	0	Channel 3
1	1	Channel 4

## 19.3 PROFINET REGISTERS FOR COMMAND SENDING

Data	Byte	DESCRIPTION																		
<i>Not used</i>	0	Always 0.																		
<i>Command</i>	1	Main available commands:																		
		<table border="1"> <thead> <tr> <th>Value</th> <th>Command</th> </tr> </thead> <tbody> <tr> <td>00 Hex</td> <td>No command</td> </tr> <tr> <td>01 Hex</td> <td>Scale zeroing</td> </tr> <tr> <td>02 Hex</td> <td>Tare</td> </tr> <tr> <td>03 Hex</td> <td>Preset Tare</td> </tr> <tr> <td>0A Hex</td> <td>Setpoint 1 setting</td> </tr> <tr> <td>0B Hex</td> <td>Setpoint 2 setting</td> </tr> <tr> <td>19 Hex</td> <td>Digital output setting</td> </tr> <tr> <td>22 Hex</td> <td>Reboot the weight transmitter</td> </tr> </tbody> </table>	Value	Command	00 Hex	No command	01 Hex	Scale zeroing	02 Hex	Tare	03 Hex	Preset Tare	0A Hex	Setpoint 1 setting	0B Hex	Setpoint 2 setting	19 Hex	Digital output setting	22 Hex	Reboot the weight transmitter
		Value	Command																	
		00 Hex	No command																	
		01 Hex	Scale zeroing																	
		02 Hex	Tare																	
		03 Hex	Preset Tare																	
		0A Hex	Setpoint 1 setting																	
		0B Hex	Setpoint 2 setting																	
19 Hex	Digital output setting																			
22 Hex	Reboot the weight transmitter																			
<i>Parameter 1</i>	2 <sub>(MSB)</sub>	First parameter of the command. Parameter is always expressed in absolute mode (no decimals, no sign).																		
	3																			
	4																			
	5 <sub>(LSB)</sub>																			
<i>Parameter 2</i>	6 <sub>(MSB)</sub>	Second parameter of the command. Parameter is always expressed in absolute mode (no decimals, no sign).																		
	7																			
	8																			
	9 <sub>(LSB)</sub>																			
	10 <sub>(MSB)</sub>	Used in advanced configuration, refer to the complete Fieldbus manual for further information.																		
	...																			
	31 <sub>(LSB)</sub>																			

## EXAMPLE 1

For zeroing the weight on the scale:

2. Set the command in byte 2

Byte	Value
1	00 Hex
2	01 Hex

## EXAMPLE 2

For setting a preset tare of 1000 lb:

1. Set the tare value in parameter 1 (byte 3, 4, 5, 6)  
2. Set the command in byte 2

Byte	Value
1	00 Hex
2	03 Hex
3 <sub>(MSB)</sub>	00 Hex
4	00 Hex
5	03 Hex
6 <sub>(LSB)</sub>	E8 Hex





© Rice Lake Weighing Systems Content subject to change without notice.

230 W. Coleman St. • Rice Lake, WI 54868 • USA USA: 800-472-6703 • International: +1-715-234-9171